



**HAL**  
open science

## ‘Adaptation’ in Children – A GUI Interaction Based Task-Performance Study

Yogesh Deshpande, Pradeep Yammiyavar, Samit Bhattacharya

► **To cite this version:**

Yogesh Deshpande, Pradeep Yammiyavar, Samit Bhattacharya. ‘Adaptation’ in Children – A GUI Interaction Based Task-Performance Study. 3rd Human Work Interaction Design (HWID), Dec 2012, Copenhagen, Denmark. pp.22-34, 10.1007/978-3-642-41145-8\_3. hal-01463375

**HAL Id: hal-01463375**

**<https://inria.hal.science/hal-01463375>**

Submitted on 9 Feb 2017

**HAL** is a multi-disciplinary open access archive for the deposit and dissemination of scientific research documents, whether they are published or not. The documents may come from teaching and research institutions in France or abroad, or from public or private research centers.

L’archive ouverte pluridisciplinaire **HAL**, est destinée au dépôt et à la diffusion de documents scientifiques de niveau recherche, publiés ou non, émanant des établissements d’enseignement et de recherche français ou étrangers, des laboratoires publics ou privés.



Distributed under a Creative Commons Attribution 4.0 International License

# ‘Adaptation’ in Children - A GUI Interaction Based Task-Performance Study

Yogesh Deshpande<sup>1</sup>, Pradeep Yammiyavar<sup>1</sup>, and Samit Bhattacharya<sup>2</sup>

<sup>1</sup>Department of Design, Indian Institute of Technology Guwahati, India  
{d.deshpande,pradeep}@iitg.ernet.in

<sup>2</sup>Department of Computer Science & Engineering,  
Indian Institute of Technology Guwahati, India  
samit@iitg.ernet.in

**Abstract.** This paper describes an exploration of how children adapt their interactions with different graphical user interfaces (GUIs) in varied task situations. The effect of computer exposure, computer knowledge, attitude and motivation (computer-friendliness) on childrens’ (age 13-15 years) adaptations and performance was studied. No significant effect of computer-friendliness was found influencing their adaptations and task-performance. The participants were exposed to two different known graphical user interfaces (GUIs). The empirical data shows that participants performed equally well on both the GUIs by adapting their interactions. Also it was observed that a GUI which is rich in features facilitates user adaptations in coping with differences in task complexities. Thus between-task adaptations and adaptivity can emerge as a new usability measure for comparing alternate GUI designs, for users of all age group.

**Keywords:** Human-Computer-Interaction, User Adaptations, Graphical User Interfaces, Task Performance, Children

## 1 Introduction

Coping with different kinds of computing devices has become an essential skill for users of all ages including children. It has now become necessary for a child as young as 6 years of age to interact with various computing devices and interfaces especially in a learning environment.

As new computing and communication devices and software applications replace older ones a greater ability to adapt or discard them would be demanded of human skills. This study focuses on knowing what, when and how do children adapt to graphical user interfaces (GUIs). We have explored adaptations in interaction behaviour and task performances of children in changing situations.(Adaptation means modification in behaviour for improving performance due to change in environment.)

Empirical research work on user adaptations in interaction behaviour has been reported widely as seen in published literature some of which is reviewed below.

## 1.1 Related work.

Attempts have been made by researchers to capture factors affecting learner's task performance and to find relationships among these factors. Personal goals, computer self efficacy,[1][2] motivation,[3] computer usage, anxiety,[4] age, [5] internet efficacy and attitude[6] have been reported to influence user interactions and satisfaction which may affect the success and failure of a task. A user with high computer self-efficacy or skills may also exhibit poor performance [2]. Inability to adapt to situations causes such perception-performance difference. A review of research on types, causes, effects and adapting ability of users is presented in following paragraphs.

Some researchers have tried to characterize or model these user-adaptations. Gray et al. [7] incorporated a new fuzzy based credit assignment scheme to model user's adaptations in strategy selection. Freed et al. [8] proposed a new way of cognitive modelling i.e. modelling adaptations in one's cognitive architectures in response to changing task characteristics or situations.

In coping with different task demands users adapt their strategies and levels in using software features. Heshan Sun [9] investigated the causes of "feature-use adaptations". The observed causes were a new task, other person's influence, change in working environment, discrepancy in system response and self deliberate initiative. Hayama et al.[10] found a new way to measure user's adaptivity to software feature-use. They applied simple compression algorithm (LZW) to the user's operation log to compute compression rate i.e. user's adaptivity. Thus a new metric of measuring user's interaction adaptivity was contributed. Schmitz et al. [11] used task-technology-fit theory to explain these adaptations. They segregated task adaptations(operational adaptations) from technology adaptations(software adaptations) and additionally found their strong relationship with perceived performance.

Smith et al. [12] found a novel mechanism of detecting drop in a search engine's performance by monitoring change in user's adaptations in querying instructions. They proposed that monitoring the querying behaviour of user can be used unobtrusively to indicate failure in system and adaptively upgrade the system.

In e-learning domain Merri et al. [13] investigated adaptations in selecting a learning-task using a shared-control (user+system) mechanism. In the experimental system a personalized learning-task list is first presented by the system and later user selects his learning-task from this list. The results showed benefit of this mechanism of user-adaptation and control in enhancing task involvement and motivation. Pieschl et al.[14] processed an e-learner's interaction log and found that they adapt their learning process(time and interactions) to complexity of learning task. Between task adaptations were computed and summed to get a single score called "adaptation score" for each interaction variable. They concluded that adaptations in judged task complexity(JTC), number of accessed nodes (NAN) and use of hierarchical commands(HC) were significantly related in improving learner's performance. We have used this adaptation score ( $AS_x$  – refer section 2.1) as a measure to find magnitude of adaptations in search, modify and delete operations of users.

Grayson et al. [15] recorded eye-movement data to find whether unconventional interface design layout triggers an adaptation of visual search behaviour during repeated trials. Results of their experiment show influence of design characteristics like size, colour, boldness and location on adaptation of visual search behaviour.

The reviewed work shows no specific research related to adaptations in children using computers. Most of the findings were related to adaptations to task characteristics. Not much research has been reported about adaptations to system or interface characteristics or user's personality. The authors of this paper have therefore chosen to research on adaptation phenomena in children.

## 2 Research Questions

This study therefore focuses on investigating adaptations in children to different graphical user interfaces through tasks. The aim was to establish relationship between adaptations and task performance. Children prefer drawing and gaming activities on computers the most. The authors have investigated childrens' drawing skills on computers with different levels of task complexity and using different drawing tools(GUIs).

Terms relevant in this document are defined as follows by the authors.

i. **Computer-friendliness** = (Computer exposure) + (Computer knowledge) + (Motivation to use computer) + (Attitude towards computer)

ii. **Adaptation Score** ( $AS_X$ ) of an operation X is

$$AS_X = (|X_{T1} - X_{T2}|) + (|X_{T2} - X_{T3}|) + \dots + (|X_{T_{i-1}} - X_{T_i}|) \dots \dots \dots [14]$$

Where  $X_{T_i}$  = number of X operations during task  $T_i$  assuming tasks  $T_1, T_2, T_3 \dots T_i$  are executed in sequence.

iii. **Adaptivity** is the ability of adapting as well as achieving an ideal performance level within minimum trials in response to change in surrounding environment.

We have investigated following research questions.

**RQ1** = Does children's computer-friendliness significantly affect their drawing performance?

**RQ2** = Does task or interface complexity (tool used) significantly affect children's drawing performance?

**RQ3** = Does task or interface complexity (tool used) significantly affect children's interaction behaviour or adaptations?

### 3 Method

#### 3.1 Participants

Participants of this study were 40 students of two different English medium schools situated in Indian cities of Pune and Guwahati. The participants were familiar with Paint and PowerPoint software interfaces. The schools had computer education inbuilt in their curriculum. Details of participants are shown in Table 1.

**Table 1.** The participants

| School                  | Number / Sex     | Age        | Class | Computer Experience |
|-------------------------|------------------|------------|-------|---------------------|
| Jnana Prabodhini , Pune | 10 Boys+10 Girls | Mean=13.98 | 8 + 9 | 5 yrs               |
| Kendriya Vidyalaya IITG | 10 Boys+10 Girls |            |       |                     |

#### 3.2 Material

**Drawing Tools (Graphical User Interfaces - GUI).**The drawing tools used were Paint(PNT) and PowerPoint(PPT). Paint was included because of its simplicity and familiarity. PowerPoint was included because of its popularity and ease-of-use. During informal group discussions with participants they were asked to give feedback on their perceptions about the two interfaces. These were counter checked with the task evaluator's opinions. They are summarized qualitatively in Table 2.

**Table 2.** Comparison of the drawing tools

| Parameter   | Paint   | PowerPoint |
|-------------|---------|------------|
| Major use   | Drawing | Slides     |
| Features    | Low     | High       |
| Complexity  | Low     | High       |
| Ease-of-use | High    | Low        |

**Computer-friendliness preset questionnaires.** Two questionnaires were designed for scaling computer-friendliness.



*Questionnaire (Q1).* – Consisted of 14 objective and 3 subjective items grouped into two scales capturing computer-exposure and computer-knowledge. Computer exposure was measured as usage in hours/week at home and at school. Computer knowledge was measured as knowledge of computer hardware, internet and applications.

*Questionnaire (Q2).* – Consisted of 15 objective and 1 subjective items grouped into two scales capturing computer-motivation and computer attitude. Motivation

was measured in terms of motivation for e-learning, computer affinity and possessiveness. Computer attitude was measured in form of beliefs and initiatives.

**Target Tasks.** Total four drawing tasks T1,T2,T3,T4 were administered to the child subjects as shown in Table 3.

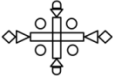
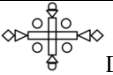
**Table 3.** The drawing tasks

| Task | Diagram   | Drawing Tool     | Time Allotted |
|------|---|------------------|---------------|
| T1   |  D1(Simple)  | PowerPoint (PPT) | 5 minutes     |
| T2   |  D2(Complex) | Paint (PNT)      | 5 minutes     |
| T3   |  D2(Complex) | PowerPoint (PPT) | 5 minutes     |
| T4   |  D1(Simple) | Paint (PNT)      | 5 minutes     |

**Task-Performance Evaluation.** To remove variability or bias in task evaluation, three evaluators evaluated the tasks of each participant. Average age of evaluators was 28 with experience of two years in design. Drawings were evaluated on the basis of how close the final outcome matches with the master-drawings D1 and D2 in all aspects. Each drawing task was evaluated using a 10 point scale. Average of evaluator's scores was treated as task-performance score for that task.

### 3.3 Procedure

Twenty boys (20 numbers) and girls (20 numbers) from class 8 and 9 of two schools (Table 1) were chosen for the experiments. Participants were chosen randomly by the class-teacher. They were briefed about the study and asked to complete two questionnaires Q1 and Q2. After the questionnaire survey participants were given drawing tasks on computers. They were asked to complete four tasks as mentioned in Table 3 using appropriate drawing tools (refer Fig. 1.). Total time consumed for the entire experiment was around 1 hour. To judge drawing performance, drawing outputs were evaluated by expert evaluators having design expertise. (Refer *Task-Performance Evaluation* paragraph in previous section).



Fig. 1. Participants performing tasks

stand childrens' mental model, beliefs and perceptions about GUI features.

All drawing tasks were recorded using CamStudio Version 2.00 (Copyright 2001-2003 by RenderSoft). The full-screen region was recorded with Microsoft Video-1 compression format, square yellow high-lighted cursor without audio recording.

Semi-structured group interviews in two groups, were conducted to under-

#### 4 Results And Discussions

Encoded questionnaire data was entered into statistical software (SPSS version-17) for analysis. Task performance scores were also computed and entered into SPSS.

The participants' computer exposure, knowledge, motivation and attitude data was normalized to 10. The statistics of this data for the entire sample population is summarized in Fig. 2. and Table 4.

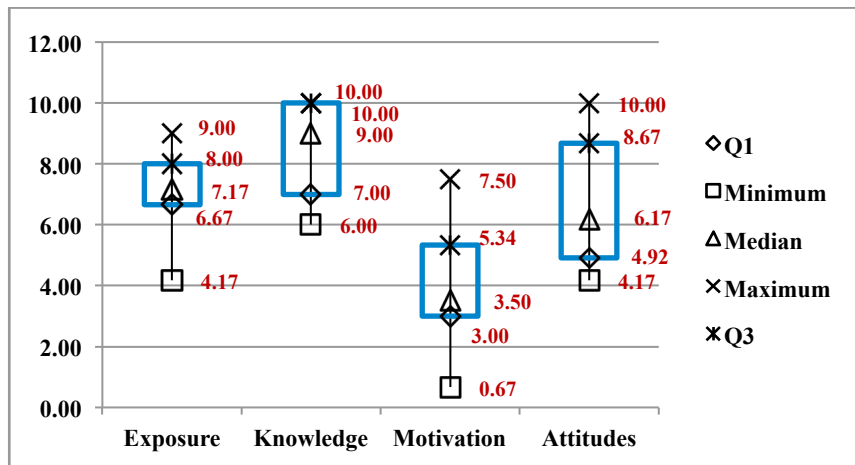

Fig. 2. Comparison of computer-friendliness constructs of sample population

Table 4. Computer friendliness constructs of sample population

| Statistic | Exposure    | Knowledge   | Motivation  | Attitude    |
|-----------|-------------|-------------|-------------|-------------|
| Mean (SD) | 7.15 (1.10) | 8.50 (1.34) | 3.65 (1.63) | 6.57 (1.99) |
| Range     | 4.83        | 4.00        | 6.83        | 5.83        |

Results show that students have good knowledge of computers, high exposure to computers and possess positive attitudes towards computers. What lacks is motivation to learn. It is posited here that learning programs on computers need to be engaging and motivating for continuous learning.

#### 4.1 Research questions

**Does childrens’ computer-friendliness significantly affect their drawing-performance (RQ1)?**. To answer this question correlation was done between computer-friendliness constructs and drawing performance scores of each task and average performance as well. Average task-performance (max=10) was computed as average of task-scores of T1, T2, T3 and T4. Computer friendliness (max=40) was computed as sum of scores of computer exposure, knowledge, motivation and attitude.

The results in Table 5 indicates that none of the factors contributing to computer-friendliness viz. computer exposure, knowledge, motivation and attitude influence the task-performance significantly. To a certain extent when seen in depth computer-friendliness partially influences complex task performance.

**Table 5.** Correlation Coefficients (Computer-Friendliness, Performance ,Adaptations)

| NO |                          | 1 | 2    | 3     | 4     | 5 | 6     | 7     | 8     | 9     | 10    |
|----|--------------------------|---|------|-------|-------|---|-------|-------|-------|-------|-------|
| 1  | Exposure                 | 1 | .207 | .288  | .217  |   | .515  | .138  | .128  | .353  | .179  |
| 2  | Knowledge                |   | 1    | .665* | .473  |   | -.288 | .086  | -.327 | -.243 | .166  |
| 3  | Motivation               |   |      | 1     | .707* |   | -.224 | .389  | .247  | .218  | -.105 |
| 4  | Attitudes                |   |      |       | 1     |   | .184  | .086  | -.126 | .060  | -.316 |
| 5  | <b>Friendliness</b>      |   |      |       |       | 1 | .055  | .205  | -.031 | .108  | -.102 |
| 6  | AS <sub>Search</sub>     |   |      |       |       |   | 1     | -.080 | .097  |       | .065  |
| 7  | AS <sub>Modify</sub>     |   |      |       |       |   |       | 1     | .679* |       | .033  |
| 8  | AS <sub>Delete</sub>     |   |      |       |       |   |       |       | 1     |       | -.140 |
| 9  | <b>Total Adaptations</b> |   |      |       |       |   |       |       |       | 1     | -.024 |
| 10 | <b>Task Performance</b>  |   |      |       |       |   |       |       |       |       | 1     |

Figures from Table 5 indicates partial relationship between computer knowledge and motivation as well as between motivation and attitudes. Computer-friendliness has no direct influence on adaptations to GUIs. Therefore user’s adaptations to GUI may be connected with factors like interface design, task complexity, time constrain and interest in topic or motivation. This is investigated further in next section of this paper.

RQ1 : Computer-friendliness does not significantly affect the task-performance.



**Does task or interface complexity (tool used) significantly affect childrens' drawing performance (RQ2)?**. Dependant t-test (paired-samples t-test in SPSS) was conducted to see the effect of task-complexity on the drawing performance. For Paint with two independent tasks (simple, complex) the t statistics was  $t_{\text{paint}}(36) = 5.561$ ,  $P < 0.0005$  and for PowerPoint it was  $t_{\text{powerpoint}}(37) = 3.553$ ,  $P < 0.001$ . This shows that user's drawing performance is dependent on how complex is the drawing task. Which is evident in Fig. 3. Also the influence of task complexity on performance is more in Paint than in PowerPoint. This may be accounted to PowerPoint having more features to accommodate ease-of-change during complex tasks. An interesting hypothesis arises here: Do more features in a GUI lead to faster adaptation?

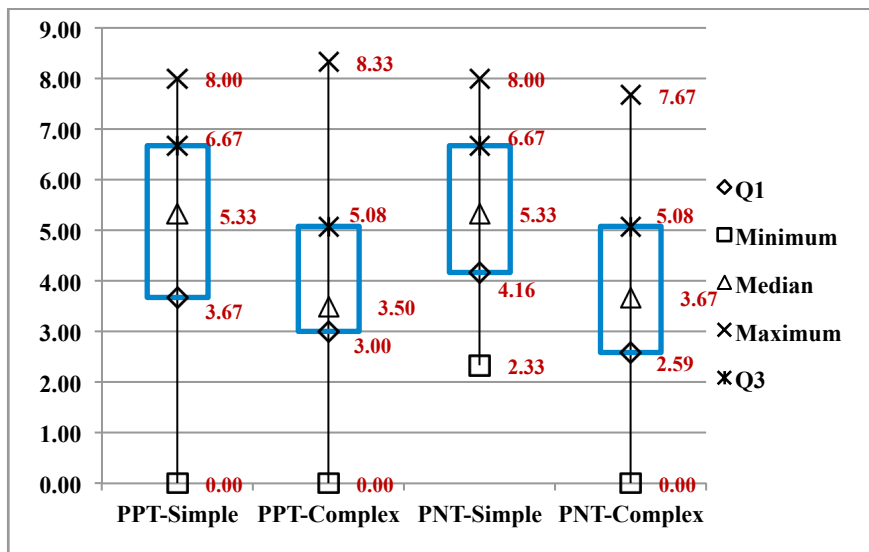

Fig. 3. Comparison of task performances

The mean task-performance in case of simple task for PPT=4.9297 and PNT=5.3338. Similarly mean task-performance in complex task situation for PPT=3.8676 and PNT=3.8429. This shows that task-performance is not influenced much by the GUI. A similar t-test was conducted to see the effect of interfaces on the drawing performances. For simple-task with two independent interfaces (Paint, PowerPoint) the t statistics was  $t_{\text{simple}}(36) = 1.321$ ,  $P < 0.195$  and for complex task it was  $t_{\text{complex}}(37) = -0.113$ ,  $P < 0.911$ . This reassures that interface is not influencing the drawing performance to that extent. This is because in difficult task situations, users adapt their GUI interactions, and thereby achieve their goal successfully and efficiently. These user-adaptations can be at two levels (a)cognitive level and (b) interaction level. The second one is explored further in this paper.

RQ2 : The results of this experiment show that children once familiar with a particular GUI show differences in their performances only because of complexity of task executed and not the GUI. They adjust very well to the complexity of known GUIs in keeping performances same. Therefore when exposed to a new interface a child will

adapt and perform well (do less errors and take less time) after some trials or learning period. In this case what matters is how quickly he can adapt (adaptivity) to an interface. Are these adaptations or adaptivity dependant on interface characteristics or does it depend on individual abilities needs investigation.

Semi structured interviews of participants were conducted to investigate their perceptions and belief in this regards. These are depicted in the cause-effect diagram (Fig. 4).

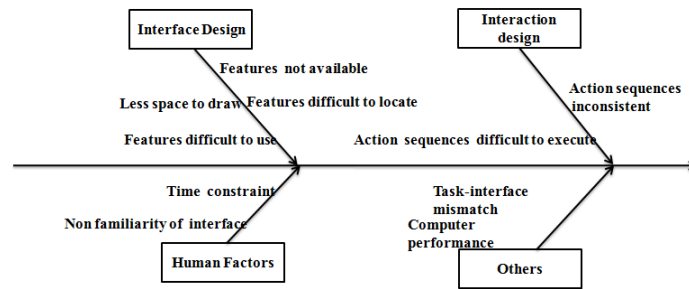

Fig. 4. Cause-effect diagram for poor drawing performance

**Does task or interface complexity (tool used) significantly affect childrens’ interaction behaviour or adaptations (RQ3)?**. To monitor interaction behaviour the search(S), modify(M) and delete(D) operations during each tasks (T1 .. T4) were computed by observing the Cam Studio video recordings of these tasks. It was observed that 95% of all operations were mainly search, modify and delete. Adaptation-Score(AS) [14] for each individual for each of these operations was computed as follows

$$AS_{search} = (|S_{T1}-S_{T2}|) + (|S_{T2}-S_{T3}|) + (|S_{T3}-S_{T4}|)$$

$$AS_{modify} = (|M_{T1}-M_{T2}|) + (|M_{T2}-M_{T3}|) + (|M_{T3}-M_{T4}|)$$

$$AS_{delete} = (|D_{T1}-D_{T2}|) + (|D_{T2}-D_{T3}|) + (|D_{T3}-D_{T4}|)$$

The statistics obtained for the entire group is shown in Table 6 and Fig. 5.

Table 6. Adaptation Scores Stasticics

| Statistic | AS <sub>Search</sub> | AS <sub>Modify</sub> | AS <sub>Delete</sub> |
|-----------|----------------------|----------------------|----------------------|
| MEAN (SD) | 11.55 (6.409)        | 17.36 (7.270)        | 15.00 (7.253)        |
| RANGE     | 17                   | 22                   | 22                   |

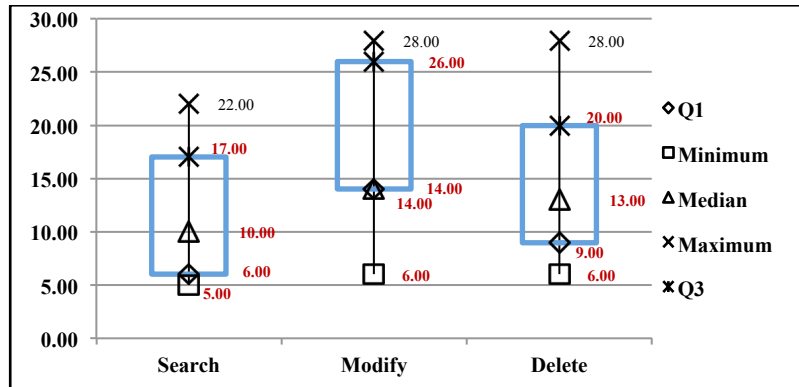

Fig. 5. Comparison of Adaptation Scores of interaction variables

Figure 5. shows high adaptation score for ‘modify’ operations compared to ‘delete’ and ‘searches’. It means that a child shows more adaptation in ‘modify’ behaviour while drawing. Therefore if a drawing tool gives a good support and flexibility of modifying drawing elements, it will prove to be a better interface when adapting to different situations. Similarly operations showing more between-task adaptations can be identified for e-learning interfaces as inputs to UI designers.

Figures of mean search, modify and delete operations in all tasks (T1..T4) were used to draw graphs (Fig. 6.) and analyse the trend in user adaptations across tasks and GUIs. The slope of graph reflects magnitude of between-task adaptations. Steep slope means large adaptations in behaviour to cope with new exposed task or interface.

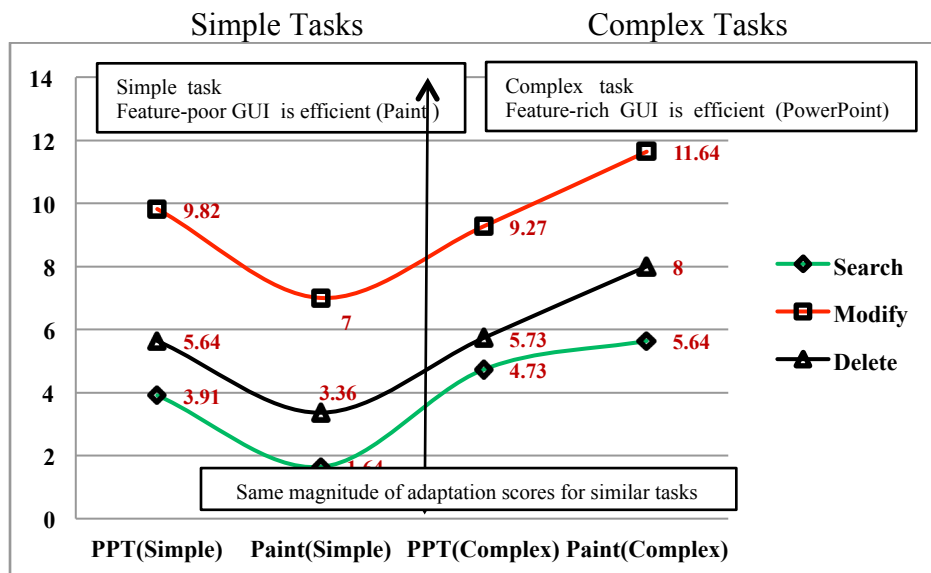

Fig. 6. Adaptation behaviour across tasks

Figure 6 shows that magnitude of adaptations (slope of graph) for both (simple and complex) tasks is same. But when considering number of operations carried out (clicks), Paint is superior during simple tasks while PowerPoint is superior during complex tasks. In conclusion an intelligent interface that adjusts the appearance of its features by sensing task complexity would be more useful from user's adaptation perspective.

User adaptation behaviour across GUIs (Fig. 7) shows that for feature-rich GUI (PowerPoint) adaptations are less than for the feature-poor GUI (Paint).

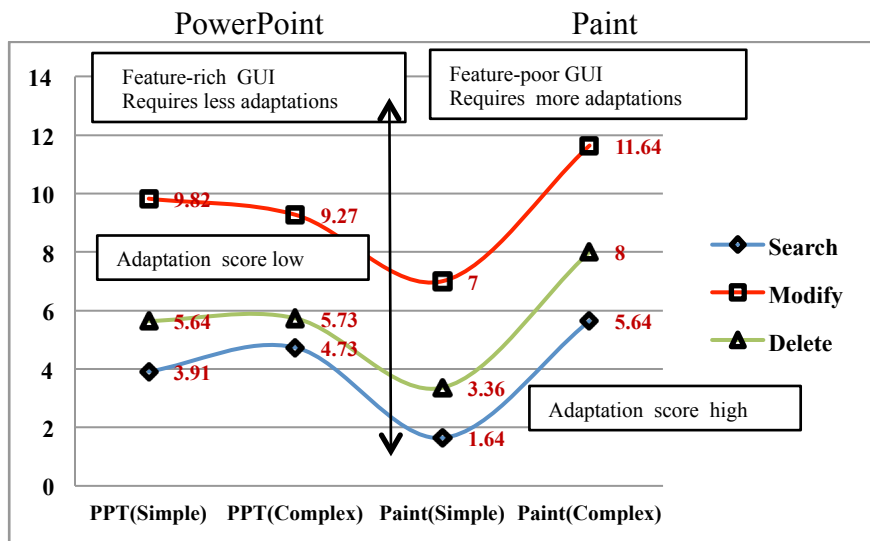

Fig. 7. Adaptation behaviour across GUIs

The conclusion we can draw is that, in situation where complexity of task is high and changes frequently a feature-rich GUI proves beneficial from adaptation perspective. While in case where task complexity is low and stable user can adapt to an adaptable GUI and reconfigure UI features depending on task. This is visualized in Fig. 8.

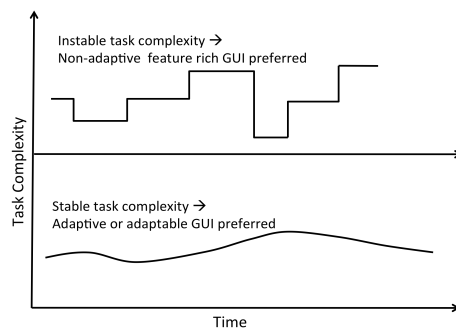

Fig. 8. Task characteristics favourable for adaptations

E-learning interfaces should fall in this second category where learning tasks vary slowly in their complexity levels influenced by the learner's strategies and style.

RQ3: The answer to this question emerges that the adaptations shown in handling simple or complex tasks are same between interfaces. (Fig. 6). However between-task adaptations (from simple to complex) show significant difference among two GUIs i.e. Paint and PowerPoint. (Fig.7). Practical implication of this is that between-task adaptation can be used as a usability measure in evaluating usefulness of alternative interface designs.

## 5 Conclusions And Future Scope

This study shows that childrens' drawing performance is neither influenced by their computer-friendliness nor by the GUI they use. Task characteristics affect the performance to a large extent.

Results also point to the fact that children show adaptations in their interactions to cope up with difficult task situations. Amount of features available in a GUI may influence these adaptations and adaptivity to changing task situations. A further study can be undertaken on this.

Lastly it was seen that a specific functionality or feature of an interface influences ease-of-adaptations like modify feature of a drawing tool. Interface designers therefore can make use of user's adaptation patterns and limits, in building "adaptation-friendly interfaces". A task-sensitive adaptive interface may be more useful in personalization and can support adaptivity in a better way.

This paper contributes to an idea of using between-task-adaptation score as a usability measure in evaluating usefulness of alternate interface designs. Can we also make use of user's adaptation pattern as a tool for cognitive modelling is an interesting question that arises.

An investigation into interface characteristics influencing user-adaptivity is required. We need to study whether features available in interface or information architecture of interface or interaction design influences adaptivity. Cognitive adaptivity and interaction adaptivity can be two promising directions for future research.

**Acknowledgements.** The authors would like to acknowledge the help extended by the Principals of Jnana Prabodhini , Pune and Kendriya Vidyalaya IIT Guwahati. We are thankful to the additional support we got from computer teaching staff Ms. Rohini Dhavale, Mr. Rajeev Patel and Mr. Lukman Khan of these schools. We would like to thank all the participating students in this study.

## References

1. M. Y. Yi. : Predicting computer task performance: Personal goal and self-efficacy. *J. Organizational and End User Computing*. 16(2),20–37(2004)
2. Smith, S. : An examination of computer self efficacy and computer-related task performance relationship. *J. Continuing Higher Education*. 47306(765),(2005)
3. Artis, S. In Thesis : The Effects of Age, Computer Self-Efficacy, and the Design of Web-Based Training on Computer Task Performance. 2005.
4. Veena, D., Joseph, S. : The effects of motivation and computer usage policies and procedures on task performance. In: *ECIS 2006 Proceedings*, paper 36. Sweden(2006)
5. Pak,R., Czaja, S. J., Sharit, J.,Rogers, W.A., Fisk,A.D. : The role of spatial abilities and age in performance in an auditory computer navigation task. *J.Computers in Human Behavior*. 24(6), 3045–3051 (2008)
6. Sun, P.-C. , Tsai, R. J. , Finger, G., Chen, Y.-Y., Yeh, D. : What drives a successful e-Learning? An empirical investigation of the critical factors influencing learner satisfaction. *J. Computers & Education*. 50(4),1183–1202(2008)
7. Gray, W. D. , Schoelles, M. J. , Sims, C. R. : Adapting to the task environment : Explorations in expected value. *J. Cognitive Systems Research*. 6(1), 27–40 (2005)
8. Freed, M. , Matessa, M. , Rehling, J., Remington, R., Vera, A. : Human-Task Adaptations : The Next Step for Cognitive Modelling. In: *IICM 2001 Proceedings*, pp. 423–425. Virginia USA(2001)
9. Sun, H. : Adaptive system use; An investigation at the system feature level. In: *ICIS 2008 Proceedings*, paper 170. Paris(2008)
10. Hayama, H. , Ueda, K. : Evaluation of Users' Adaptation by Applying LZW Compression Algorithm to Operation Logs. *J. Knowledge-Based Intelligent Information and Engineering Systems*. 3215, 625–631(2004)
11. Schmitz, K. : Exploring Technology and Task Adaptation Among Individual Users of Mobile Technology. In: *ICIS 2010 Proceedings*, paper 57. St. Louis(2010)
12. Smith, C. L. , Kantor, P. B. : User adaptation: good results from poor systems. In: *SIGIR 2008 Proceedings*, pp. 147–154. Singapore(2008)
13. Corbalan, G. : Selecting learning tasks: Effects of adaptation and shared control on learning efficiency and task involvement. *J. Contemporary Educational Psychology*. 33(4), 733–756(2008)
14. Pieschl, S., Stahl, E. : Is adaptation to task complexity really beneficial for performance? *J. Learning and Instruction*. 22(4),281–289(2011)
15. Grayson, A., Minocha, S. : Combining Eye Tracking and Conventional Techniques for Indications of User Adaptability. *IFIP Lecture Notes in ...*, 3585,753–766(2011)