

# A Low-cost Multitouch Spherical Display : Hardware and Software Design

---

Thomas Crespel, Patrick Reuter, Xavier Granier

Display week 2017 - Los Angeles

05/24/2017



**1. Context**

2. Hardware

3. Software

4. Results & Conclusion

# Low-cost multitouch spherical display

# Low-cost multitouch spherical display

- Opaque globe displaying interactive data
- All-around viewers



source : *Global Imagination*

## Applications :

- Teaching
- Collaborative work
- Communication
- ...

# Low-cost multitouch spherical display

- Opaque globe displaying interactive data
- All-around viewers
- Intuitive interaction



source : *Global Imagination*

## Applications :

- Teaching
- Collaborative work
- Communication
- ...

# Low-cost multitouch spherical display

- Costly existing products
- Spread the use

- Opaque globe displaying interactive data
- All-around viewers

- Intuitive interaction



source : *Global Imagination*

## Applications :

- Teaching
- Collaborative work
- Communication
- ...

# Related work

## Low-cost multitouch spherical display

Projection-based solutions

# Related work

## Low-cost multitouch spherical display

### Projection-based solutions

#### Global Imagination

[globalimagination.com](http://globalimagination.com)

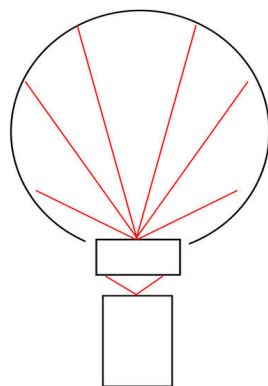

- DLP projector
- Custom fisheye lens

#### ArcScience

[arcscience.com](http://arcscience.com)

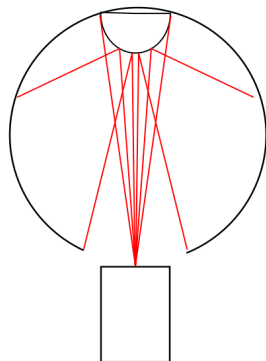

- DLP projector
- Custom hemispherical mirror
- Casts shadows on the north pole



# Related work

## Low-cost multitouch spherical display

### Projection-based solutions

#### Global Imagination

[globalimagination.com](http://globalimagination.com)

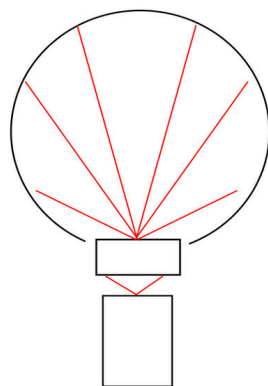

- DLP projector
- Custom fisheye lens

- Large displays
- Good quality

- Patented optical elements
- Expensive
- Not multitouch

#### ArcScience

[arcscience.com](http://arcscience.com)

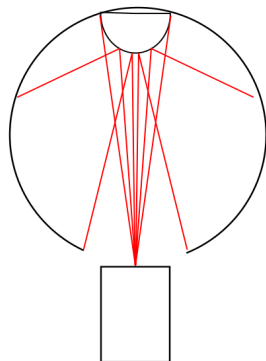

- DLP projector
- Custom hemispherical mirror
- Casts shadows on the north pole

# Related work

Low-cost multitouch spherical display

# Related work

## Low-cost multitouch spherical display

### Microsoft Research

[Benko, 2008]

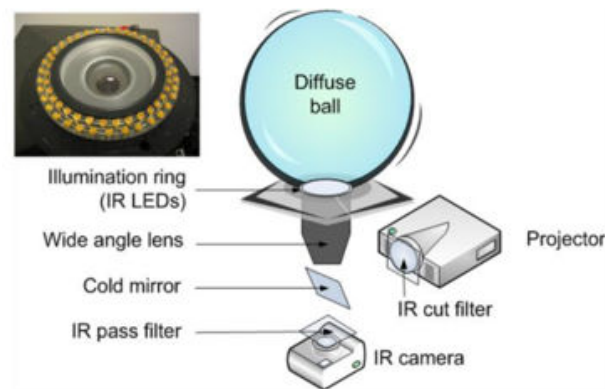

- Add multitouch capabilities to Global Imagination's product
- Cold mirror + Infrared finger tracking

### Pufferfish

[pufferfishdisplays.com](http://pufferfishdisplays.com)



- Designed and patented their own fisheye lens
- Optical tracking

# Related work

## Low-cost multitouch spherical display

### Microsoft Research

[Benko, 2008]

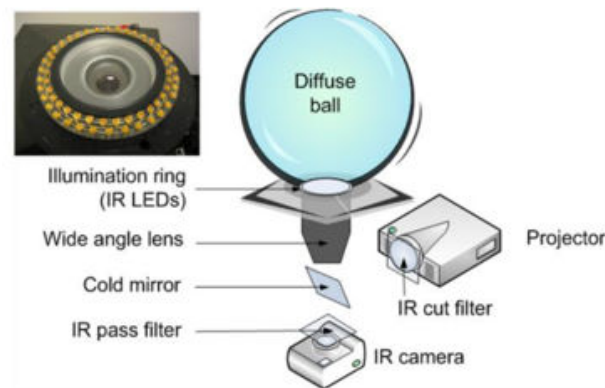

- Add multitouch capabilities to Global Imagination's product
- Cold mirror + Infrared finger tracking

### Pufferfish

[pufferfishdisplays.com](http://pufferfishdisplays.com)



- Designed and patented their own fisheye lens
- Optical tracking

- Large displays
- Good quality
- Multitouch
- Custom optics
- Expensive

# Related work

## Low-cost multitouch spherical display

### “Do-it-yourself” spherical display

<http://eclecti.cc/computergraphics/snow-globe-part-one-cheap-diy-spherical-projection>

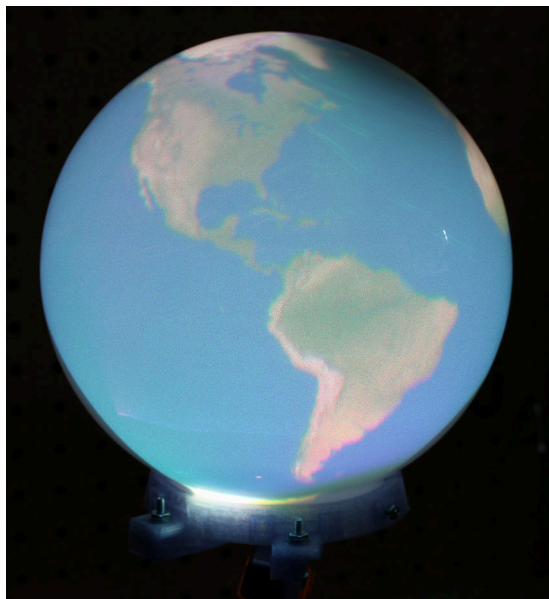

- « Focus-Free » projector
- \$30 fisheye lens
- 3D printed parts

# Related work

## Low-cost multitouch spherical display

### “Do-it-yourself” spherical display

<http://eclecti.cc/computergraphics/snow-globe-part-one-cheap-diy-spherical-projection>

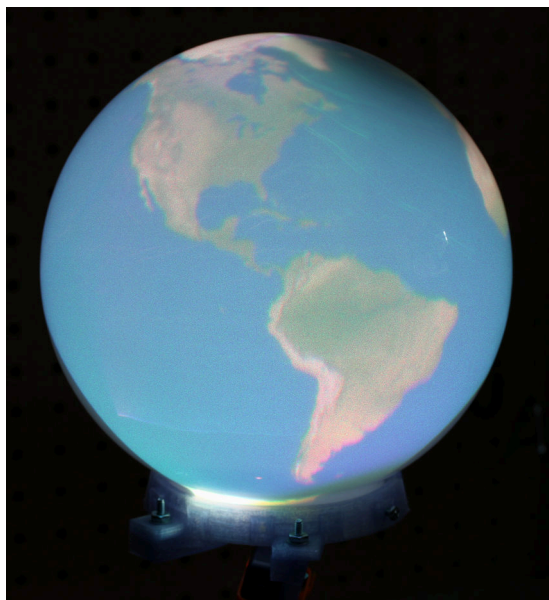

➤ « Focus-Free » projector

➤ \$30 fisheye lens

➤ 3D printed parts

- Cheaper than other solutions
- Easily reproducible

- Does not cover the entire sphere
- Not multitouch

# Our solution

## Low-cost multitouch spherical display

### HARDWARE

- Focus-free projector
- Off-the-shelf optical components
- Cold mirror
- Infrared finger tracking
- 3D printed parts

### SOFTWARE

- Projection
- Interaction
- Compensate the use of cheap optics
- Calibration

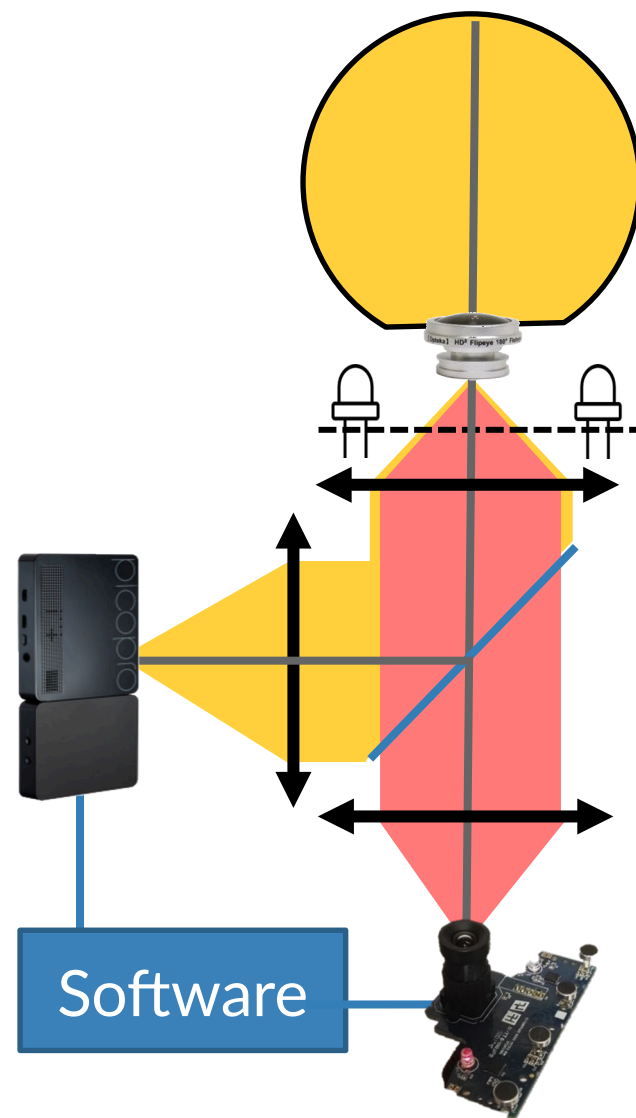

1. Context

**2. Hardware**

3. Software

4. Results & Conclusion



# Hardware – Rear projection

## Frosted glass sphere

- 24cm diameter
- Rear projection screen

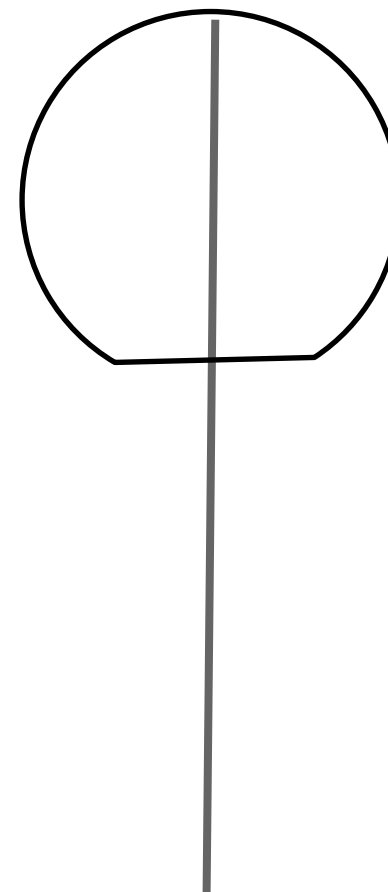

# Hardware – Rear projection

## Frosted glass sphere

- 24cm diameter
- Rear projection screen

## Fisheye lens : Opteka x0.2

- Designed for photography
- Magnification x5
- $\pm 90^\circ$  output  $\rightarrow \pm 18^\circ$  input



# Hardware – Fisheye lens

## Frosted glass sphere

- 24cm diameter
- Rear projection screen

## Fisheye lens : Opteka x0.2

- Designed for photography
- Magnification x5
- $\pm 90^\circ$  output  $\rightarrow$   $\pm 18^\circ$  input

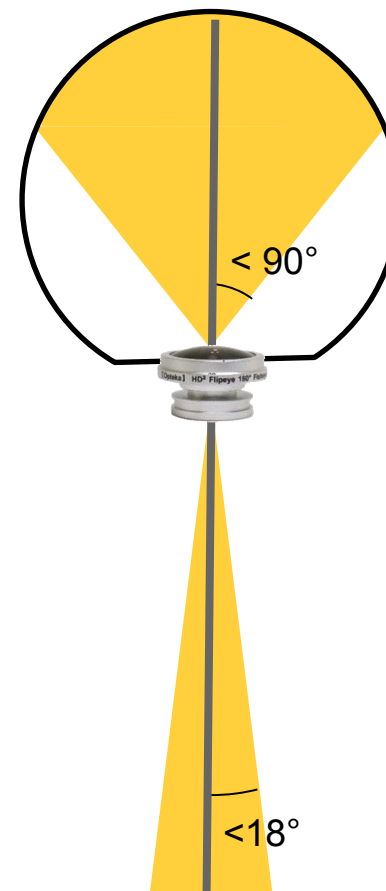

# Hardware – Fisheye lens

## Frosted glass sphere

- 24cm diameter
- Rear projection screen

## Fisheye lens : Opteka x0.2

- Designed for photography
- Magnification x5
- $\pm 90^\circ$  output  $\rightarrow \pm 18^\circ$  input

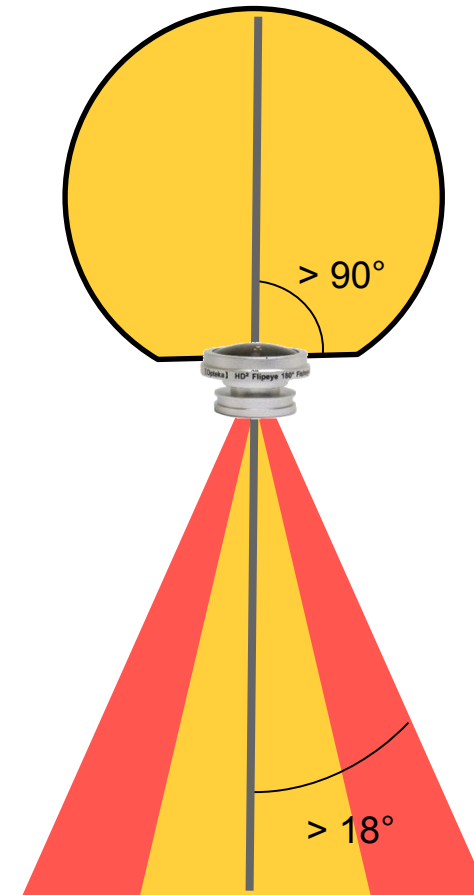

# Hardware – Fisheye lens

## Frosted glass sphere

- 24cm diameter
- Rear projection screen

## Fisheye lens : Opteka x0.2

- Designed for photography
- Magnification x5
- $\pm 90^\circ$  output  $\rightarrow$   $\pm 18^\circ$  input

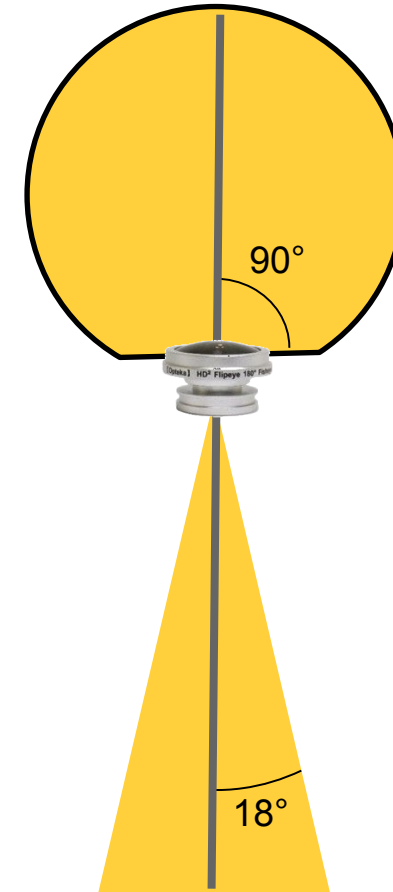

# Hardware – Projector

## Frosted glass sphere

- 24cm diameter
- Rear projection screen

## Fisheye lens : Opteka x0.2

- Designed for photography
- Magnification x5
- $\pm 90^\circ$  output  $\rightarrow \pm 18^\circ$  input

## Laser Beam-Steering Projector : Celluon PicoPro

- “Focus-free”
- Spatiotemporal scanning of R, G, B low diverging laser beams
- Specs : Brightness : 30 lumens  
Resolution : 1920x720p  
Field of view :  $\pm 11^\circ$  vertically  
 $\pm 22^\circ$

horizontally



# Hardware – Projector

## Frosted glass sphere

- 24cm diameter
- Rear projection screen

## Fisheye lens : Opteka x0.2

- Designed for photography
- Magnification x5
- $\pm 90^\circ$  output  $\rightarrow \pm 18^\circ$  input

## Laser Beam-Steering Projector : Celluon PicoPro

- “Focus-free”
- Spatiotemporal scanning of R, G, B low diverging laser beams
- Specs : Brightness : 30 lumens  
Resolution : 1920x720p  
Field of view :  $\pm 11^\circ$  vertically  
 $\pm 22^\circ$

horizontally

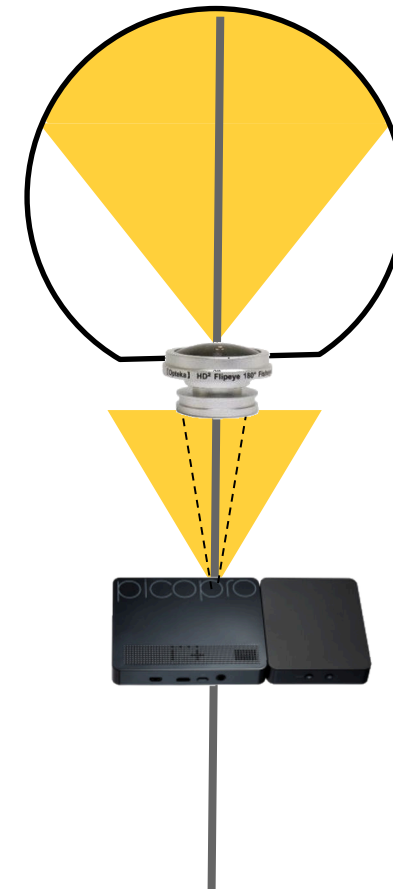

Vertically : limited by the FOV  
Horizontally : limited by the fisheye aperture

# Hardware - Imaging optical system

Goals :

- Add optical distance between projector and fisheye lens
- Adapt the input angle on the fisheye
- Maintain a sharp image

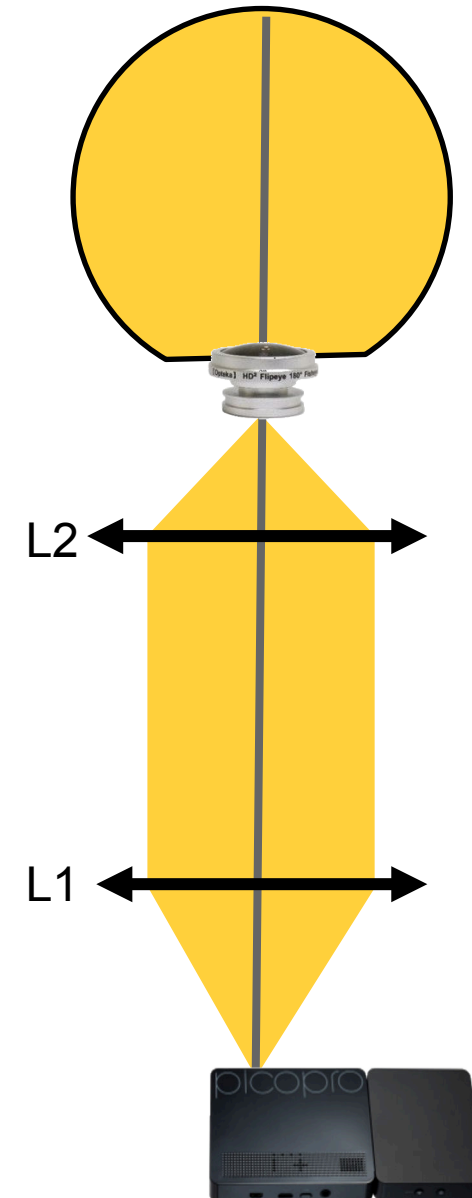



# Hardware - Imaging optical system

## Goals :

- Add optical distance between projector and fisheye lens
- Adapt the input angle on the fisheye
- Maintain a sharp image

- The envelope is focused with a correct angle
- The scanning beam has correct divergence

- The envelope is collimated
- The scanning laser beam is focused

- The vertical FOV is collected by L1

lost pixels



transmitted pixels

- The scanning laser beam is slightly diverging

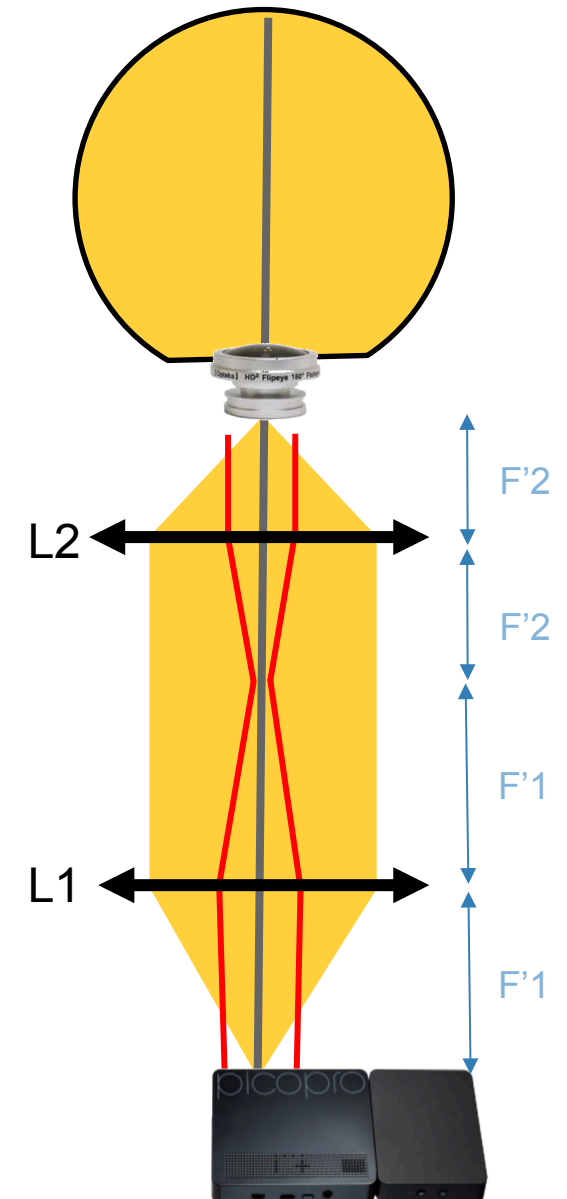

# Hardware - Optical tracking

**45° Cold mirror**  
Reflects the visible light, transparent for infrared

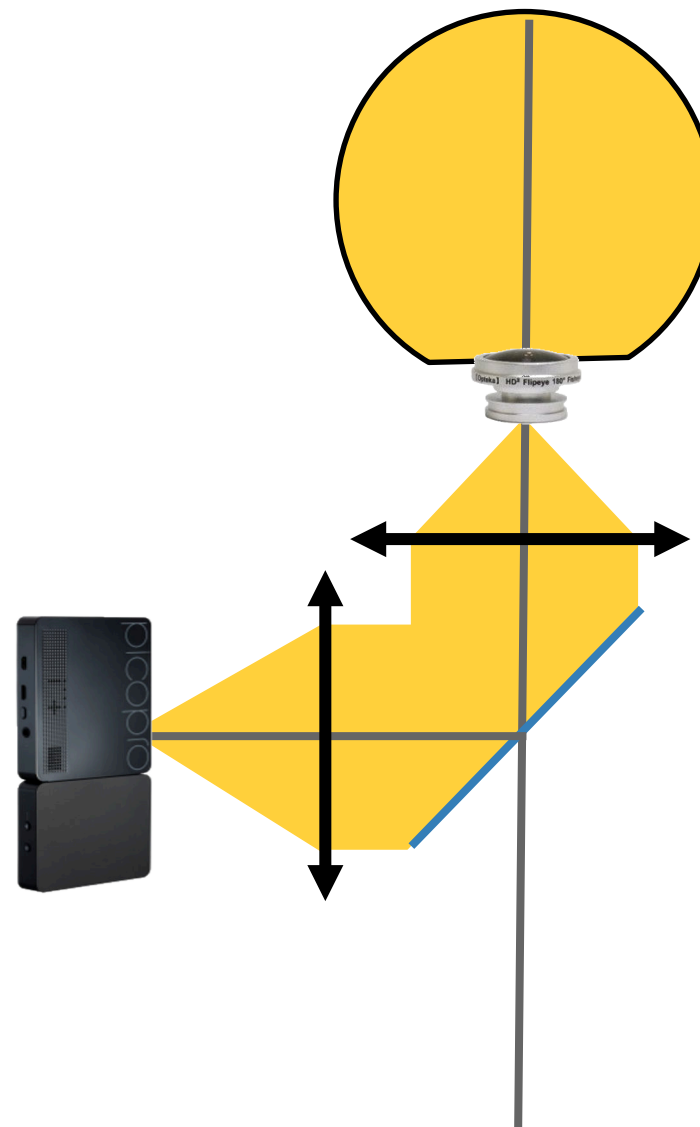

# Hardware - Optical tracking

Infrared LEDs ring @880nm

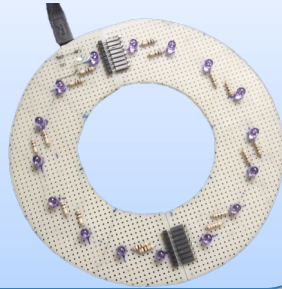

45° Cold mirror  
Reflects the visible light, transparent for infrared

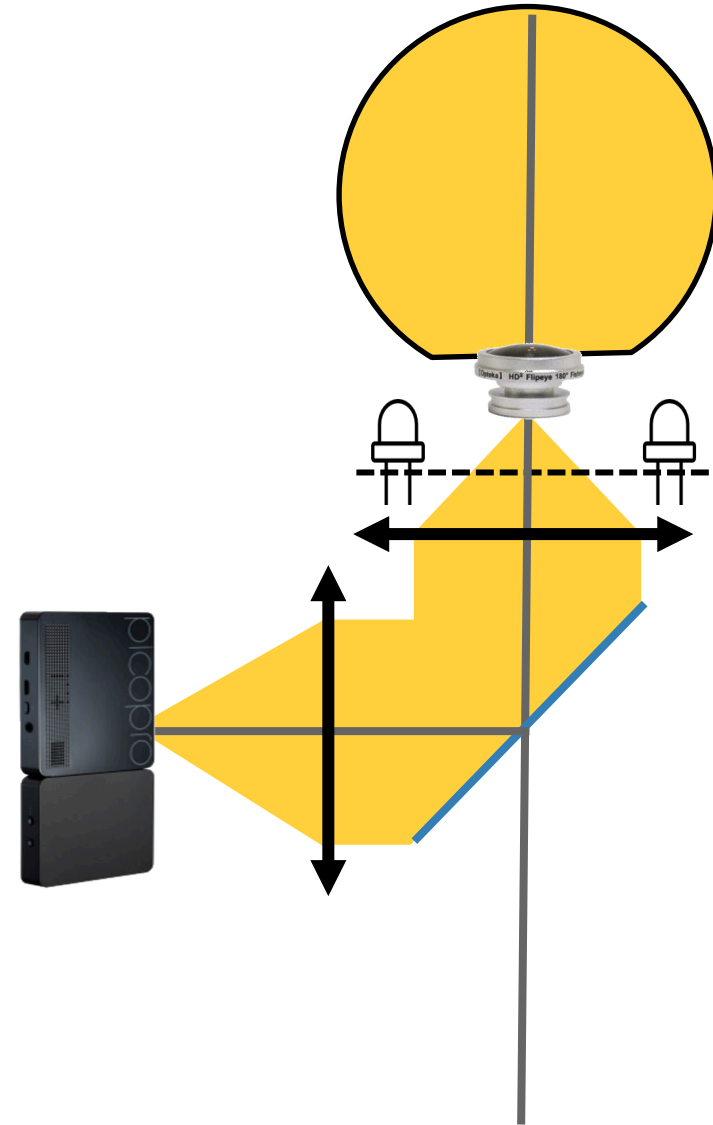

# Hardware - Optical tracking

Infrared LEDs ring @880nm

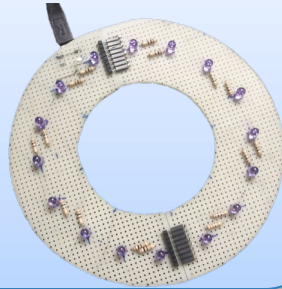

45° Cold mirror

Reflects the visible light, transparent for infrared

Modified PSeeye camera

- IR bandpass filter @880nm
- FOV : 23° vertically  
30° horizontally

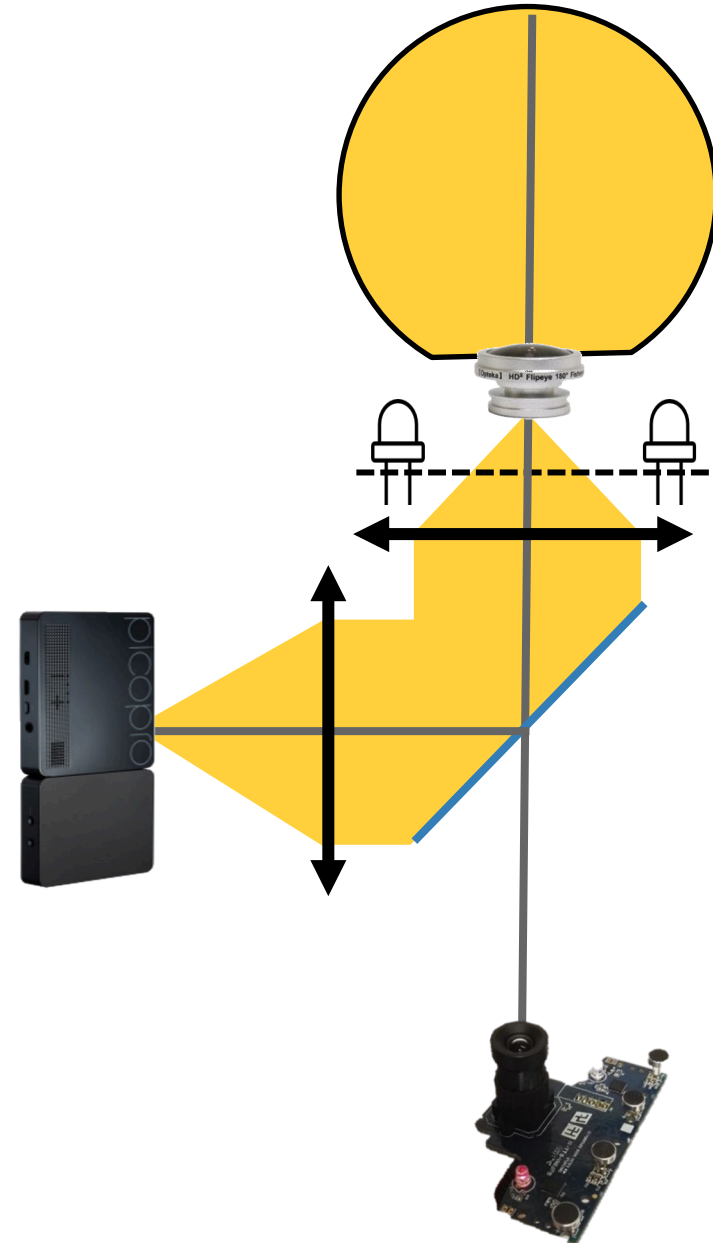

# Hardware - Optical tracking

Infrared LEDs ring @880nm

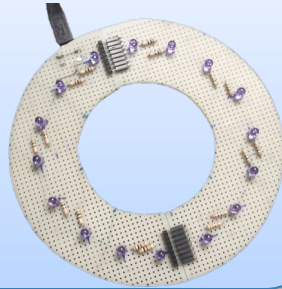

45° Cold mirror

Reflects the visible light, transparent for infrared

Modified PSeeye camera

- IR bandpass filter @880nm
- FOV : 23° vertically  
30° horizontally

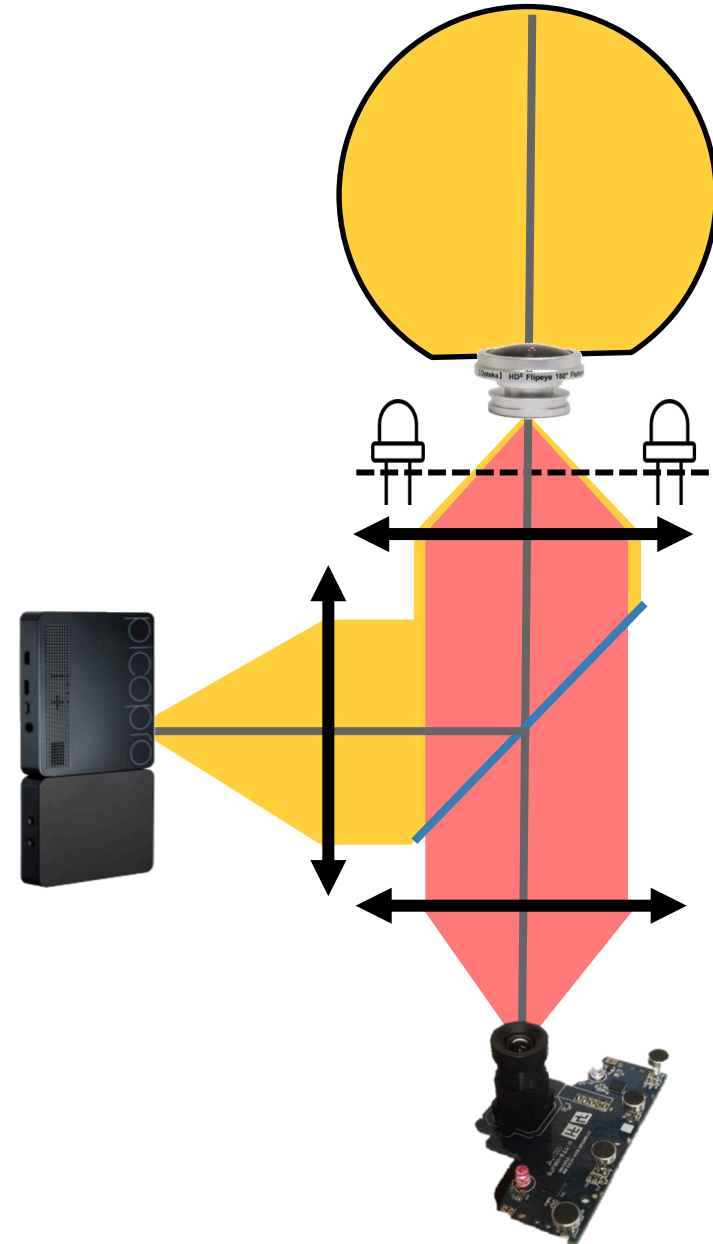

1. Context
2. Hardware
- 3. Software**
4. Results & Conclusion

# Software - Overview

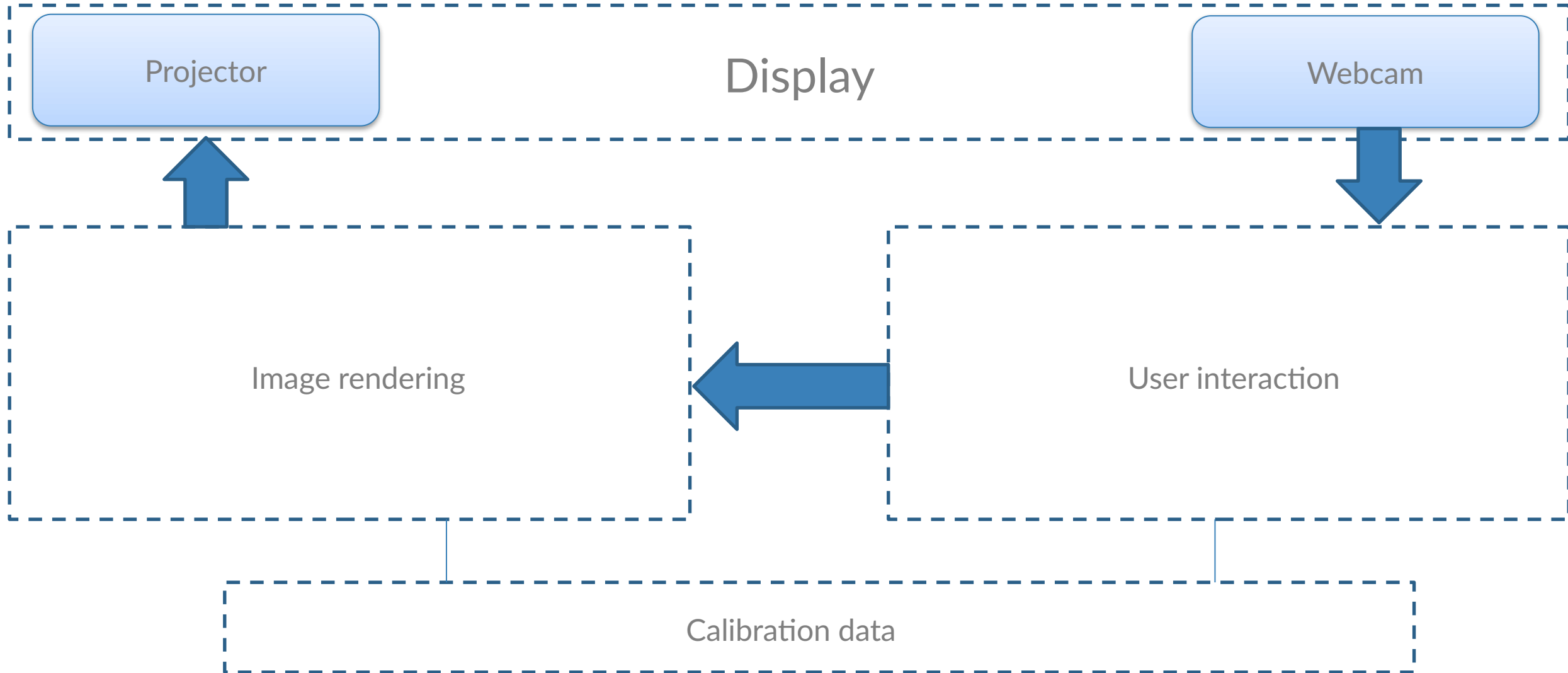

# Software - Overview

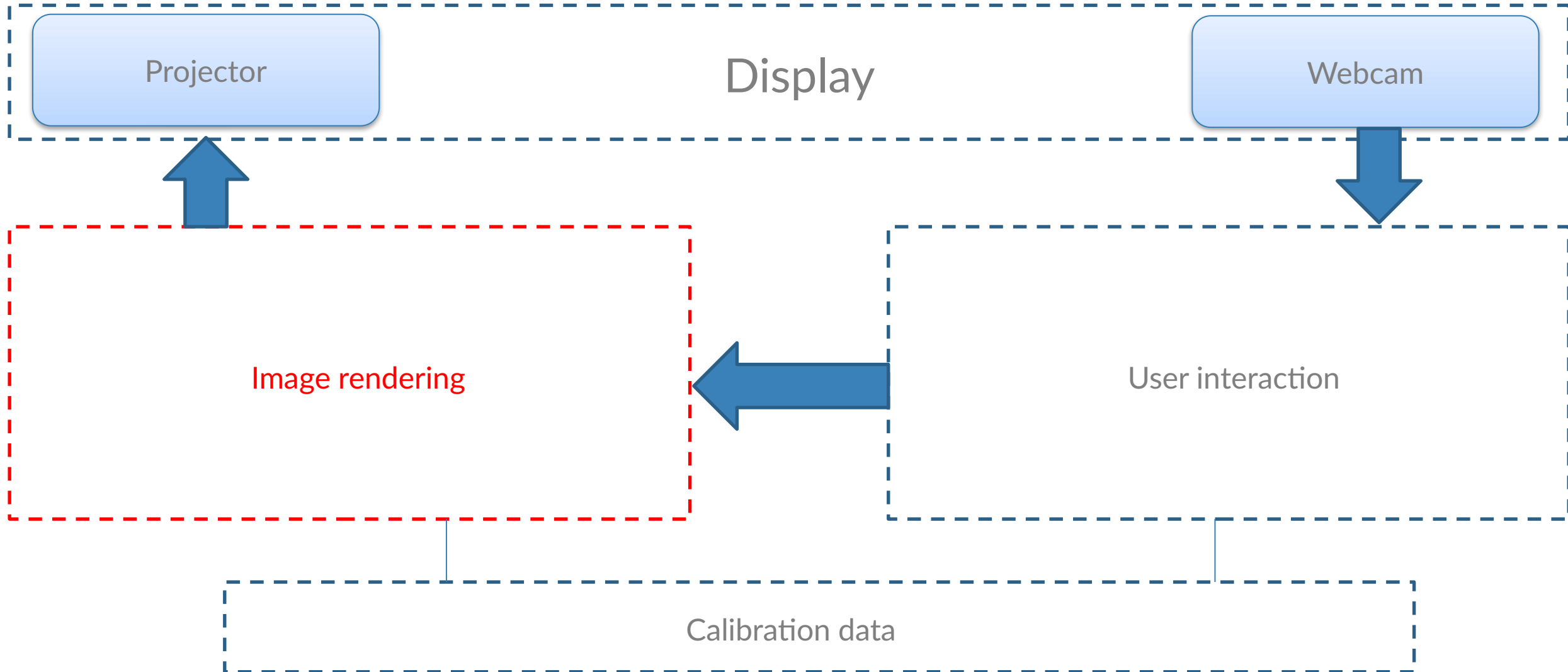



# Software – Image rendering

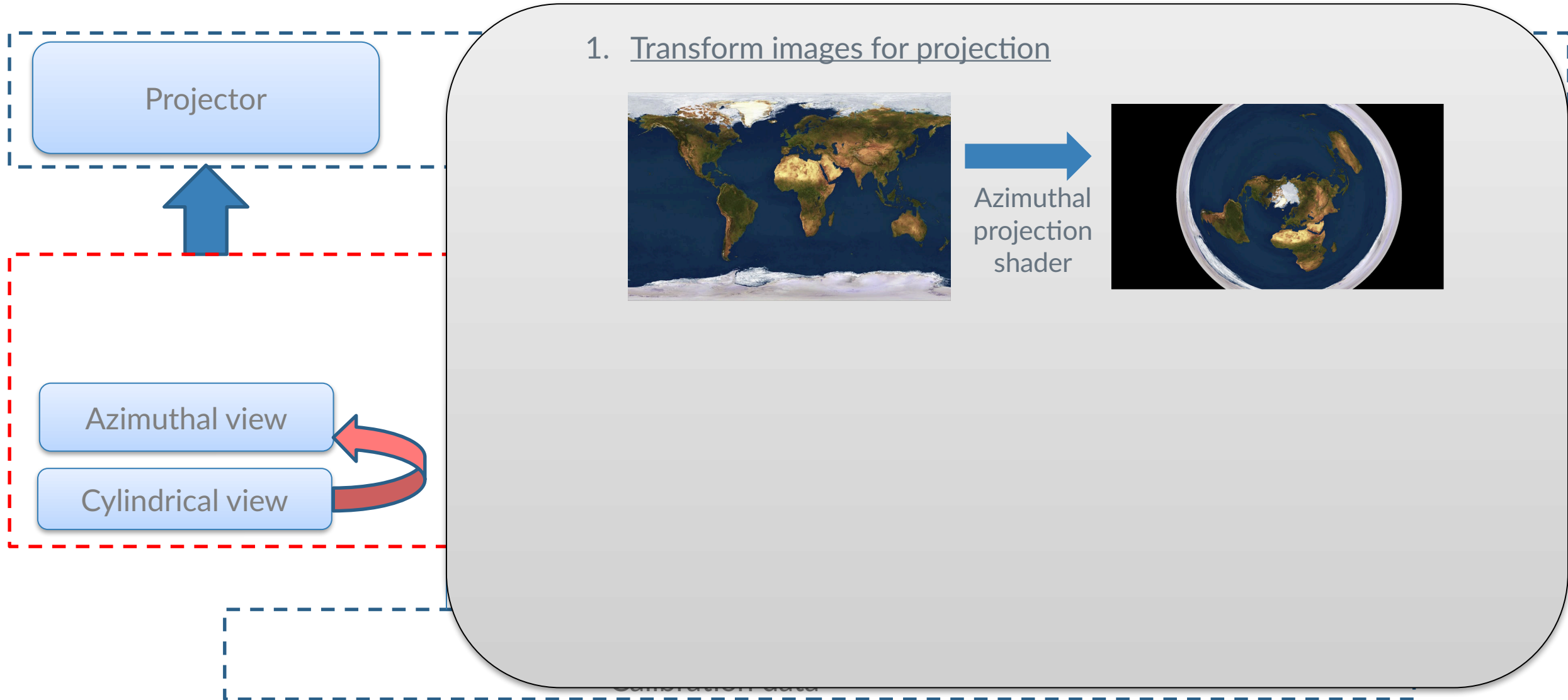

# Software - Image rendering

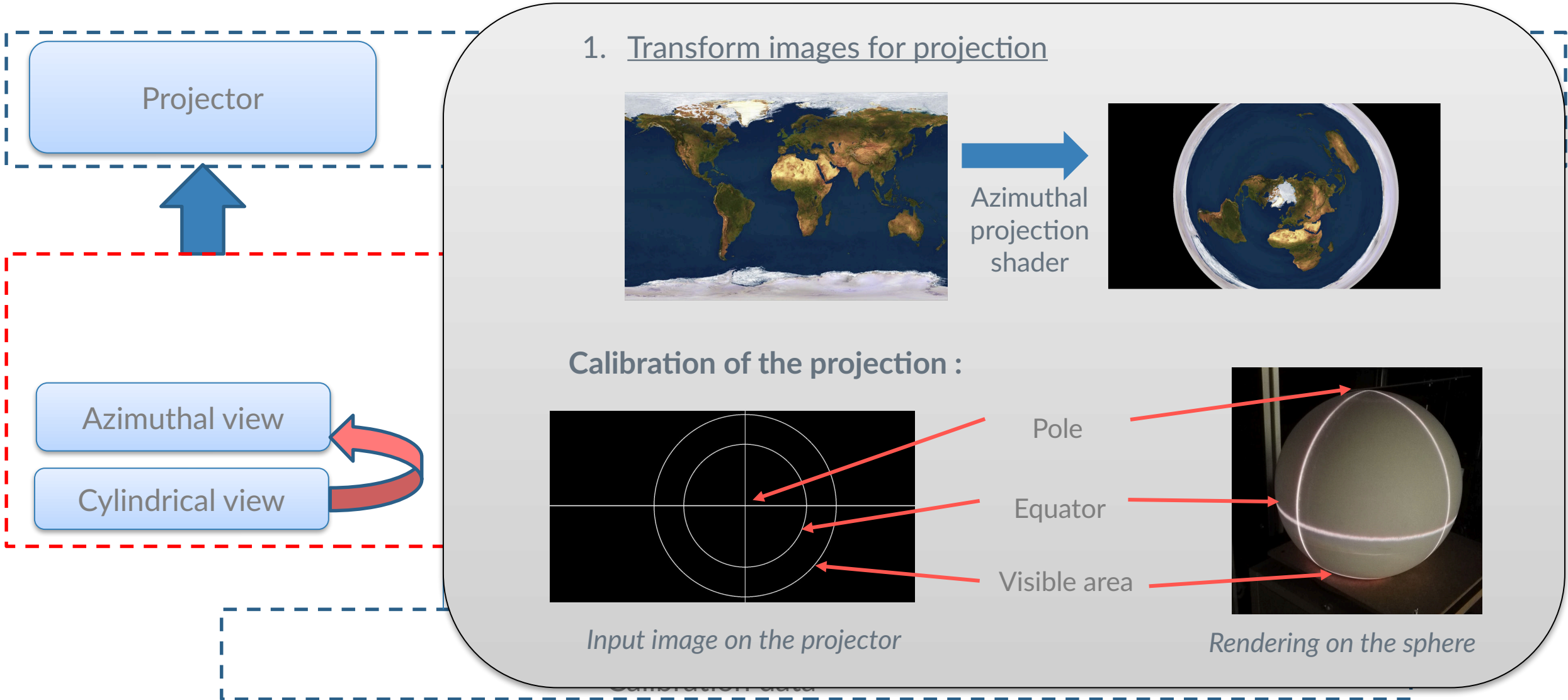

# Software - Image rendering

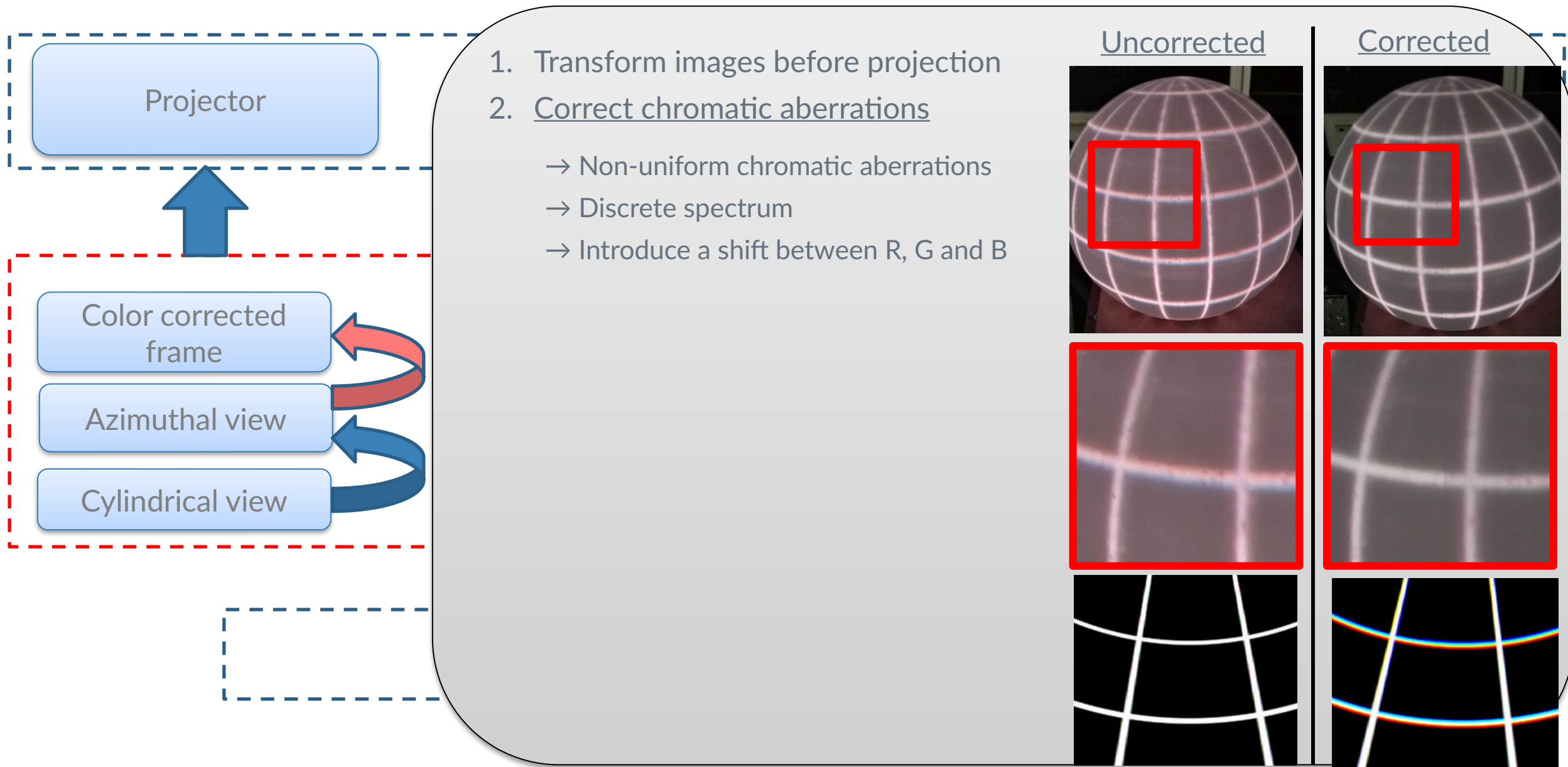

# Software - Image rendering

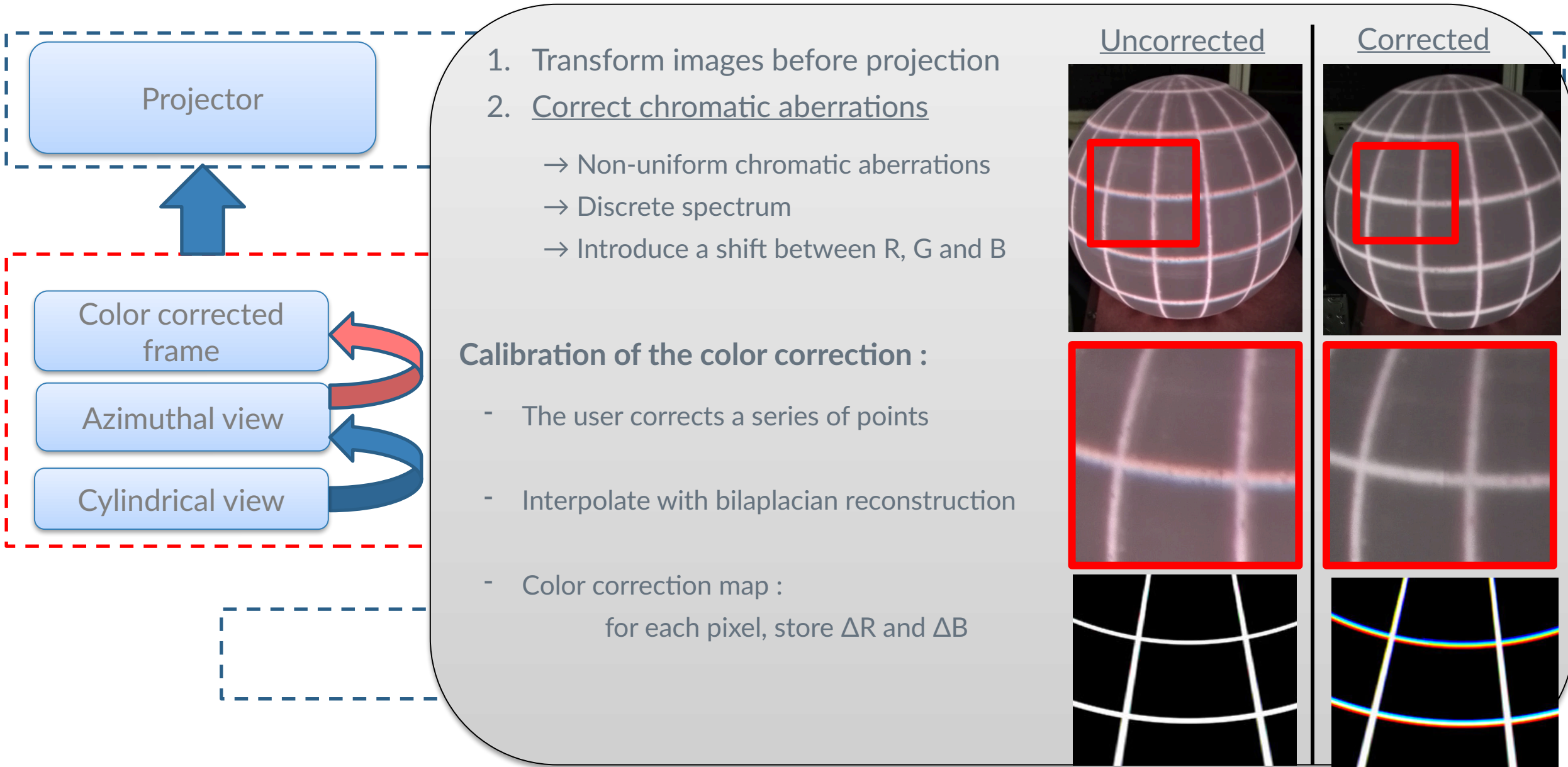

# Software - Overview

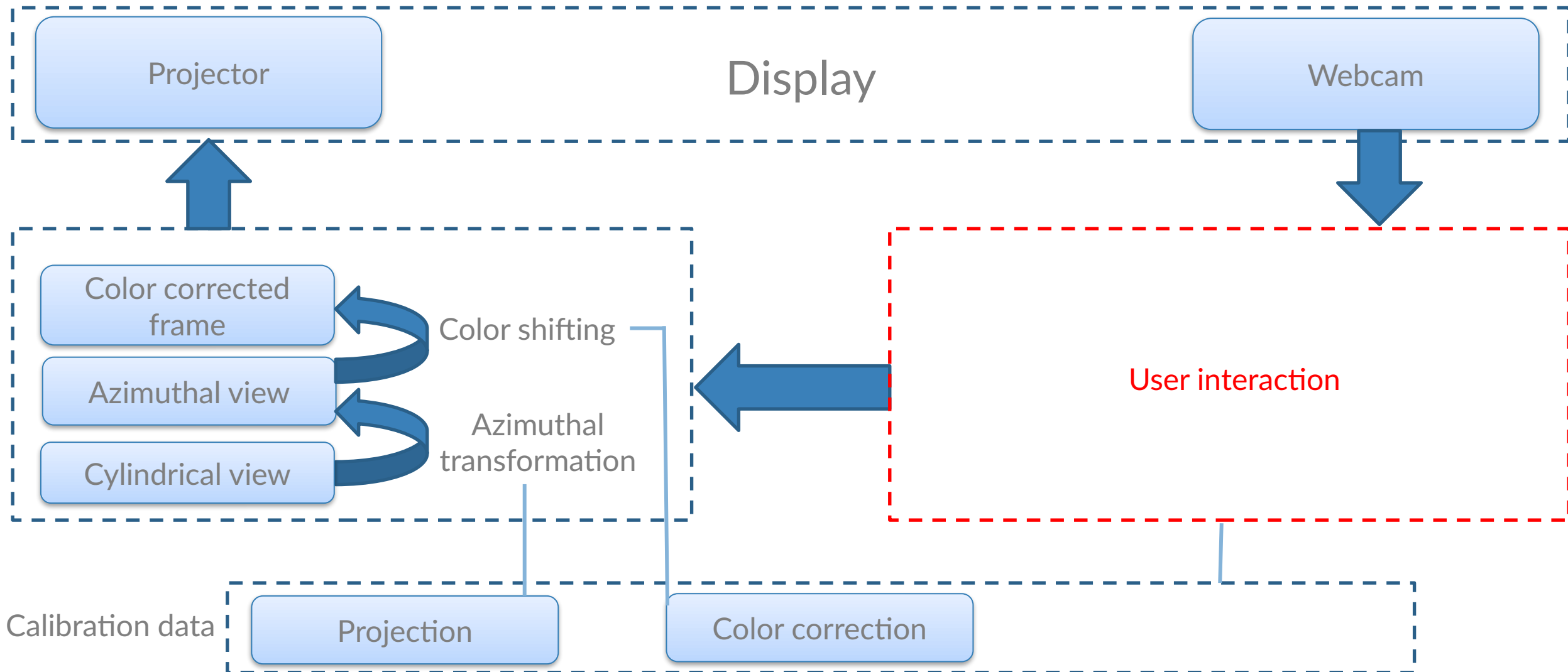

# Software – User interaction

## 1. Track the fingers

→ Computer vision algorithms

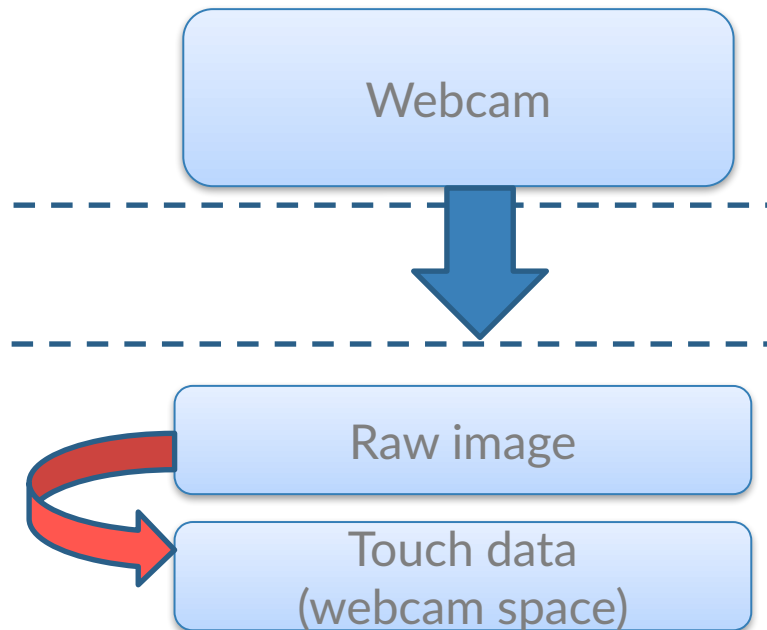

# Software – User interaction

## 1. Track the fingers

→ Computer vision algorithms

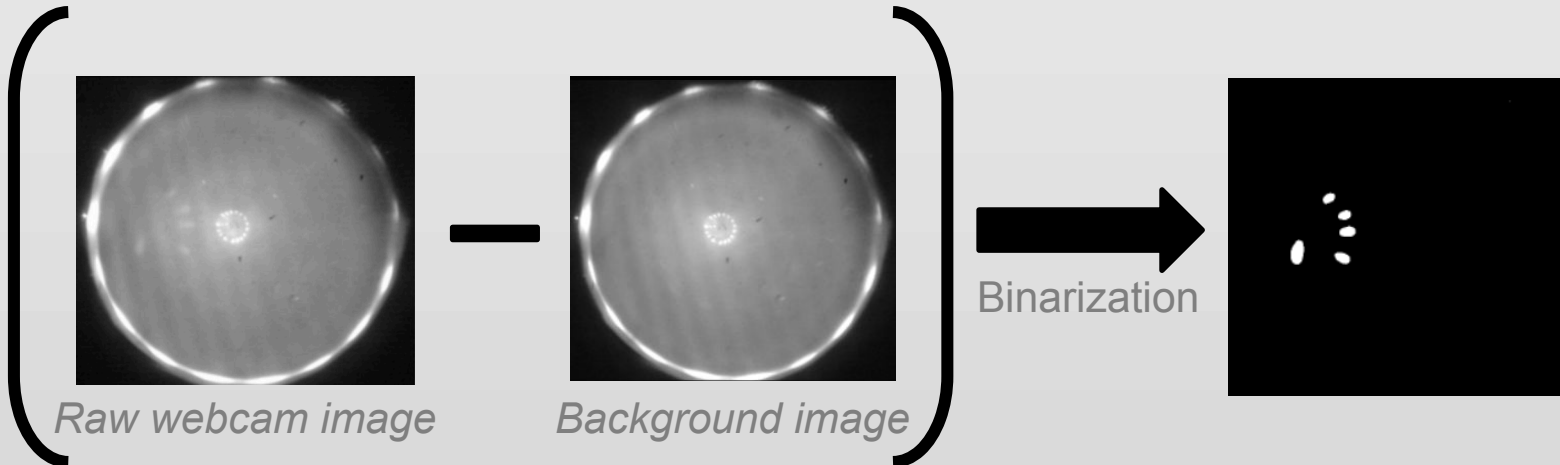

**Parameters :** Smoothing, noise removing, amplification, binarization threshold, touch size....

**Output data :** Touch position, speed, size,...

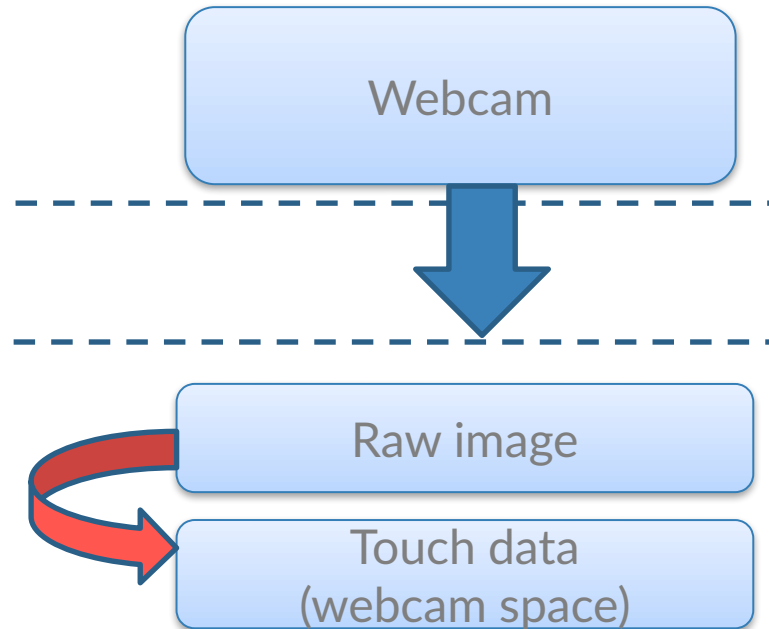

# Software – User interaction

## 1. Track the fingers

→ Computer vision algorithms

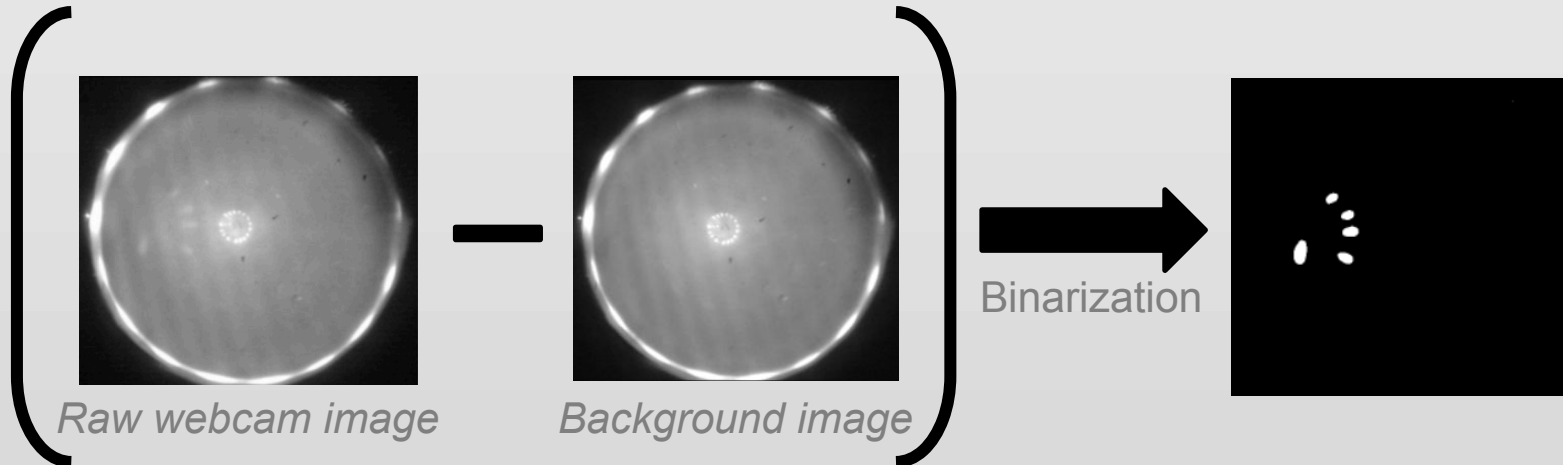

**Parameters :** Smoothing, noise removing, amplification, binarization threshold, touch size....

**Output data :** Touch position, speed, size,...

**In webcam space !**

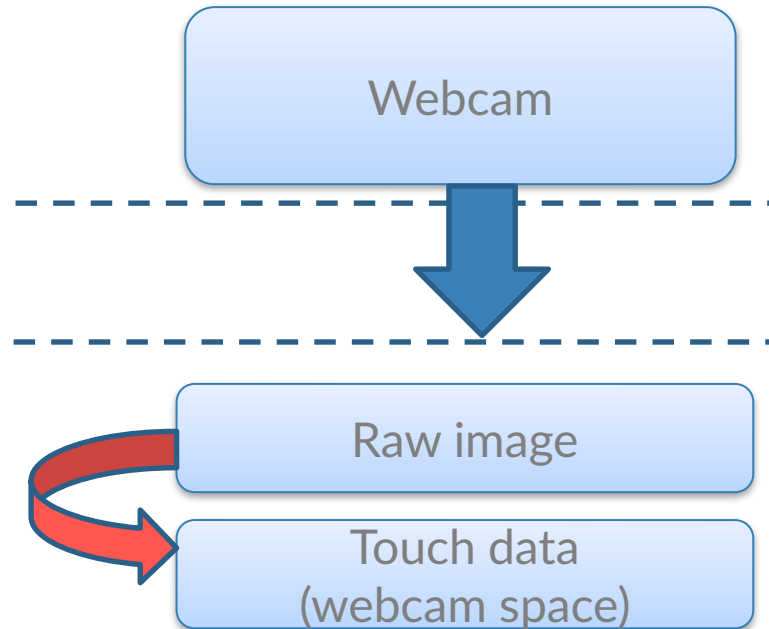



# Software – User interaction

1. Track the fingers
2. Find the corresponding pixels in the projected image

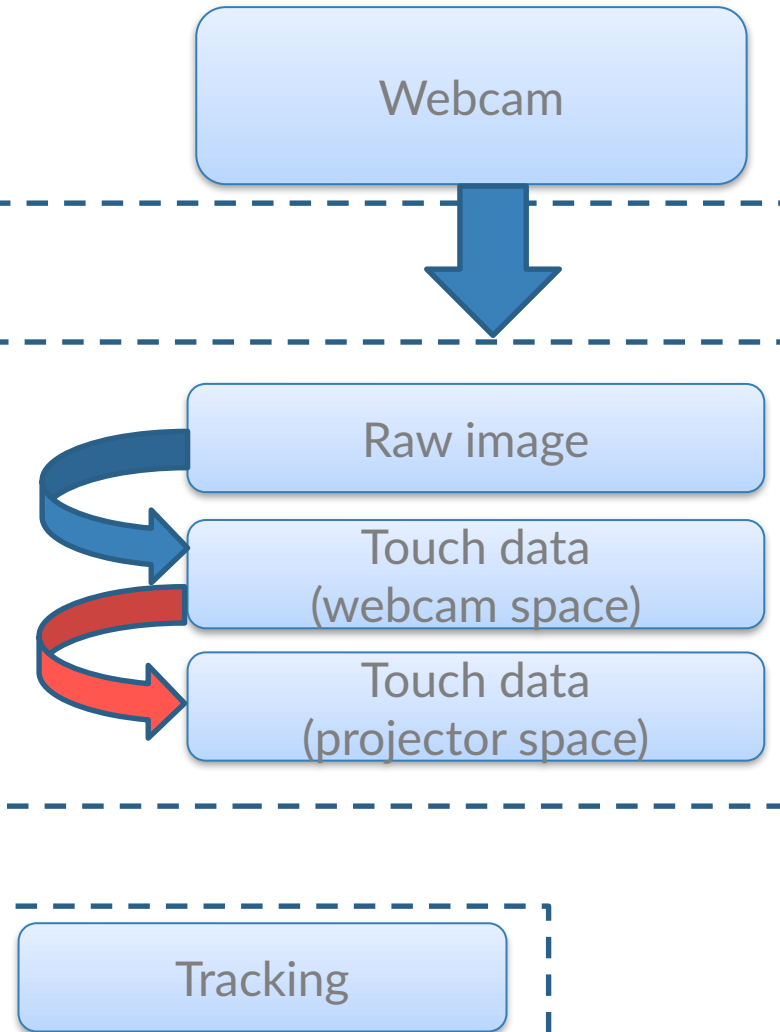

# Software – User interaction

1. Track the fingers
2. Find the corresponding pixels in the projected image

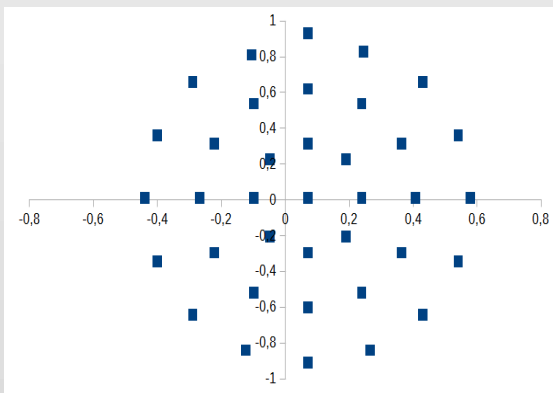

*Projected points*

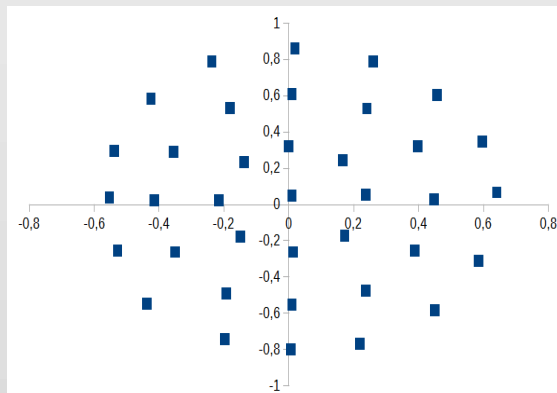

*Detected points*

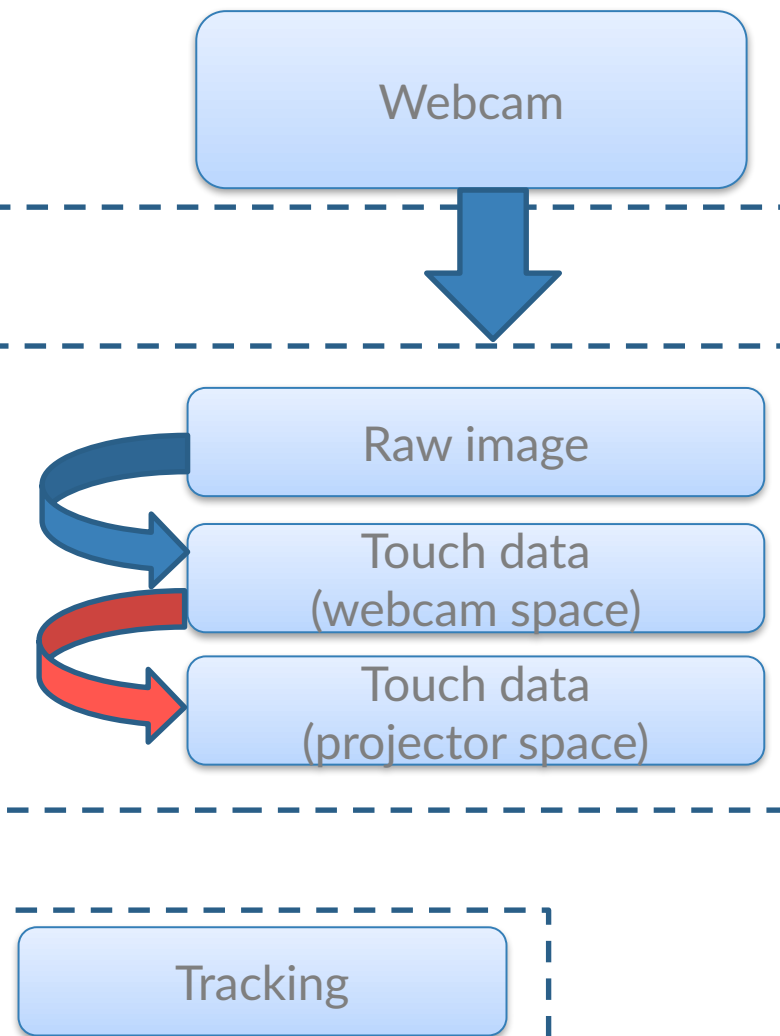

# Software – User interaction

1. Track the fingers
2. Find the corresponding pixels in the projected image

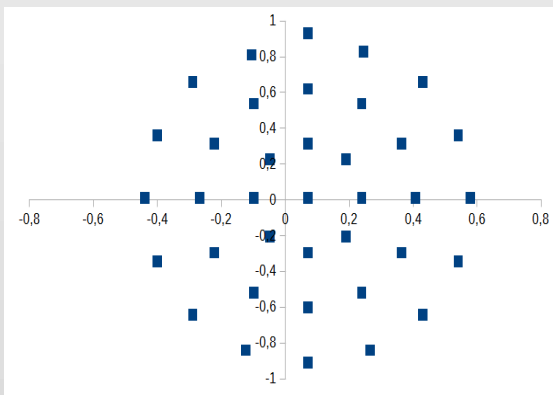

*Projected points*

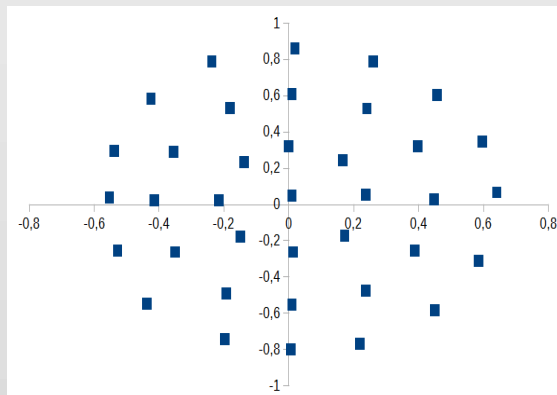

*Detected points*

## Calibration of the finger tracking:

Find a mapping  $F : (X_{\text{webcam}}, Y_{\text{webcam}}) \rightarrow (X_{\text{projector}}, Y_{\text{projector}})$

- The user touches a series of projected points
- Bilaplacian reconstruction

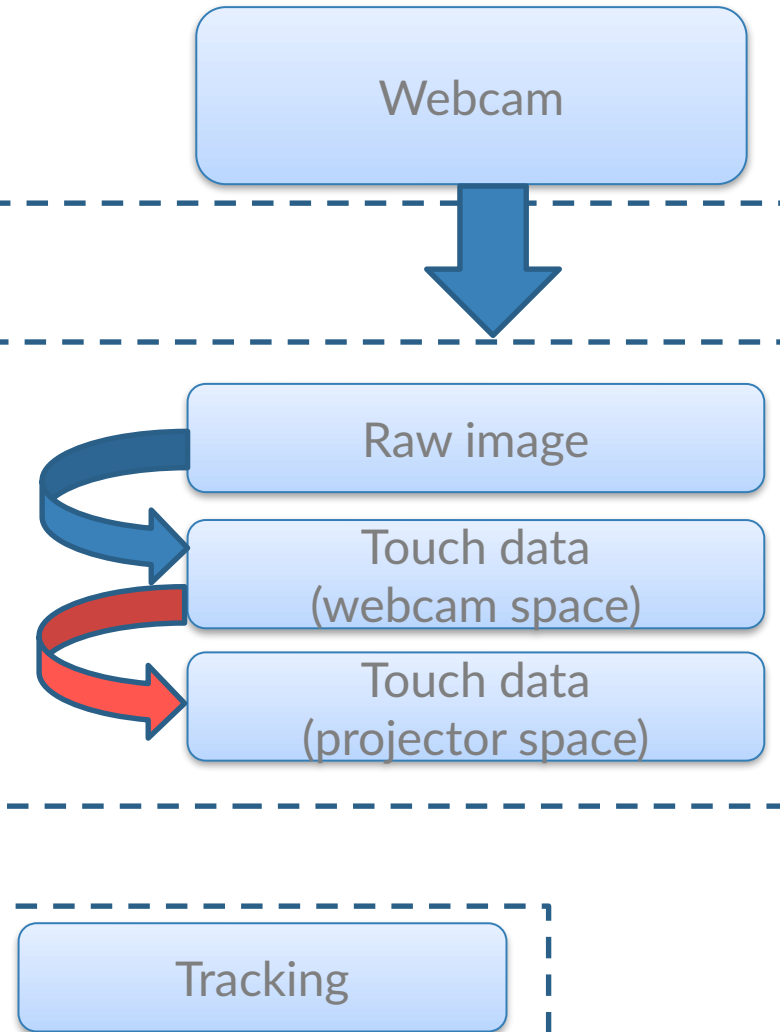

# Software - Overview

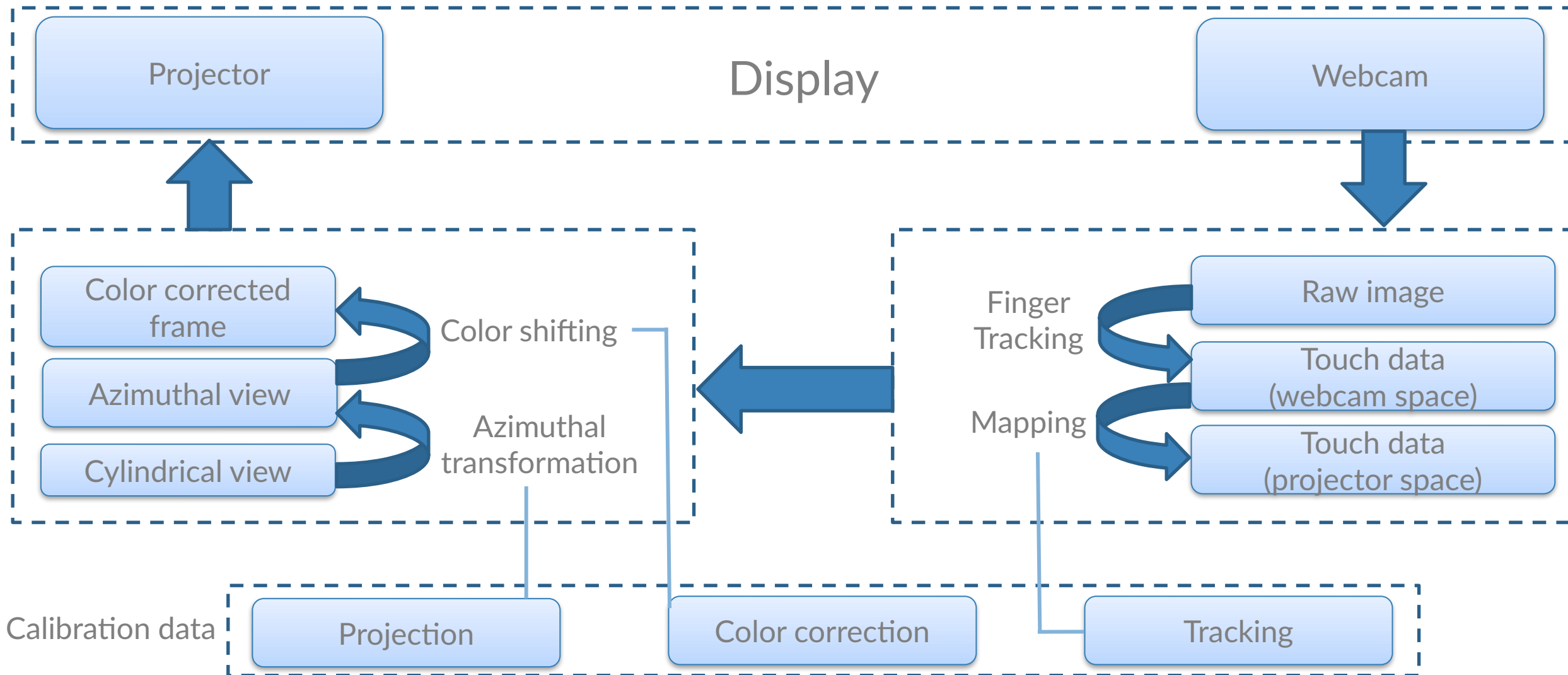

1. Context

2. Hardware

3. Software

**4. Results & Conclusion**

# Pictures and videos

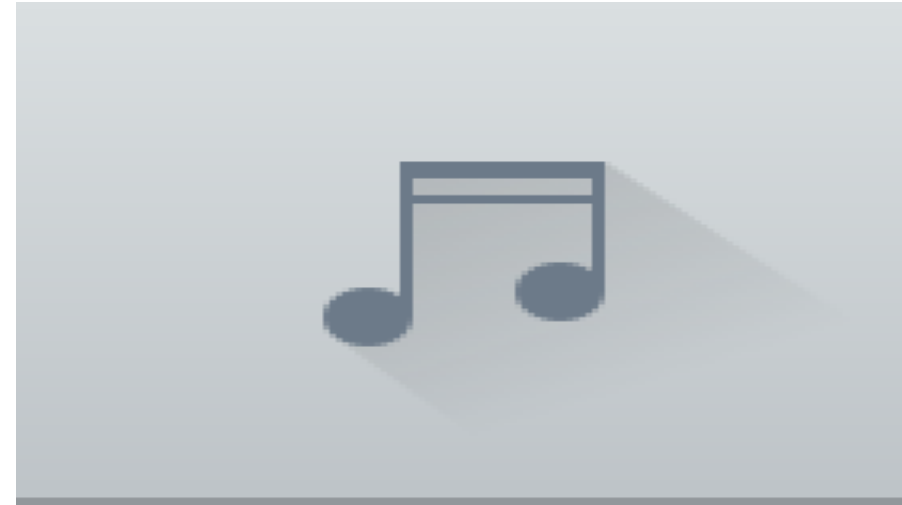
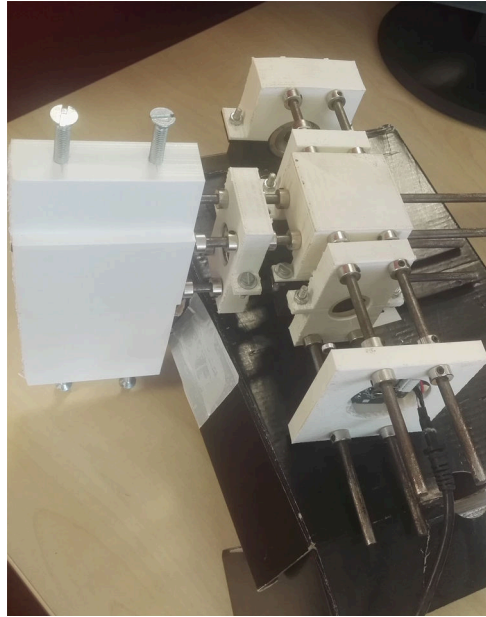

# Pictures and videos

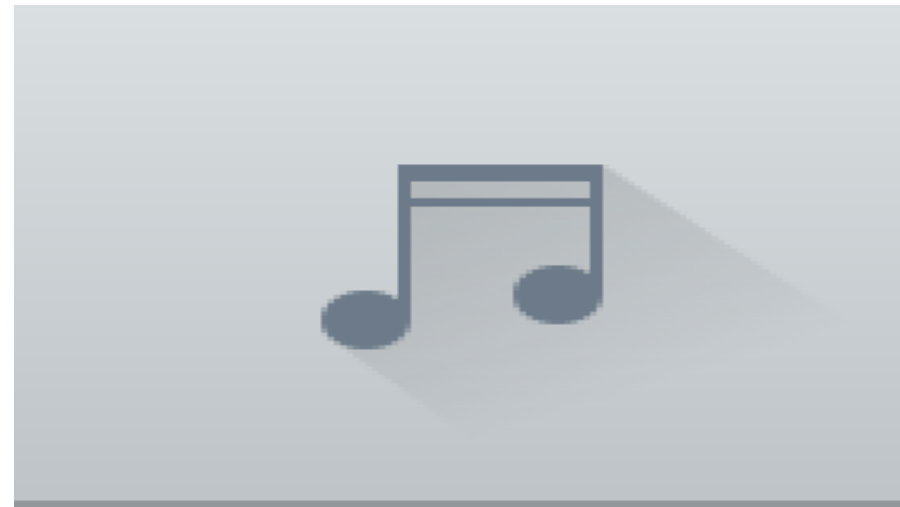
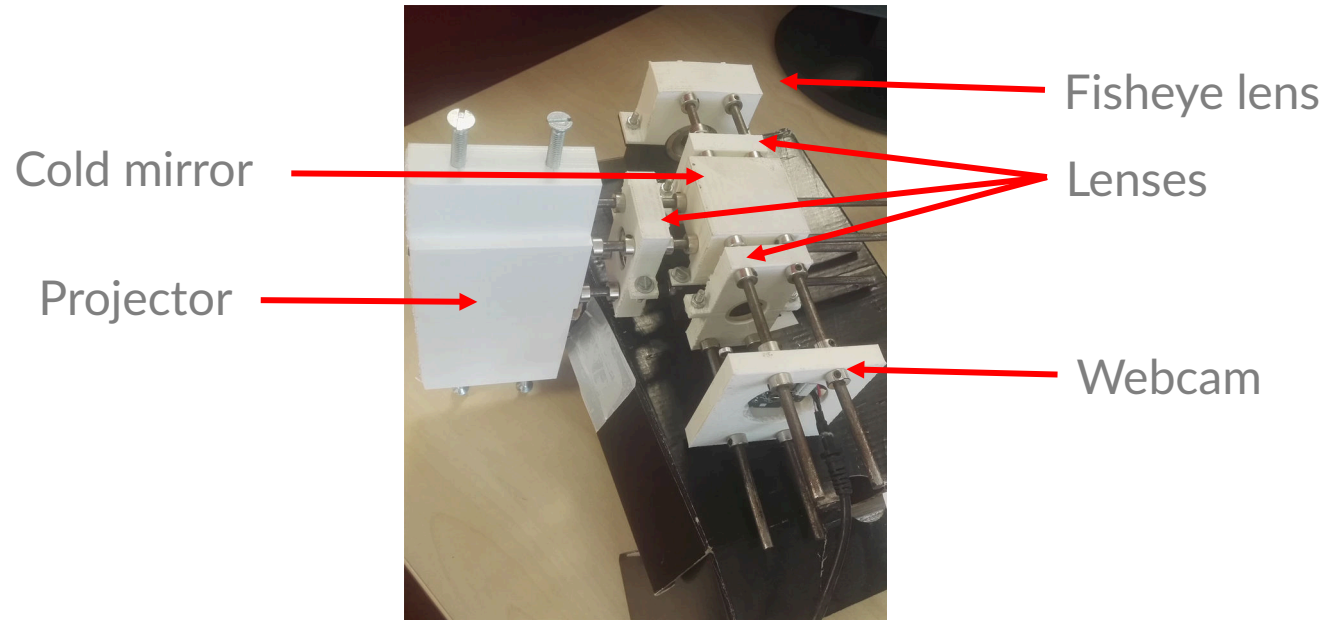

# Pictures and videos

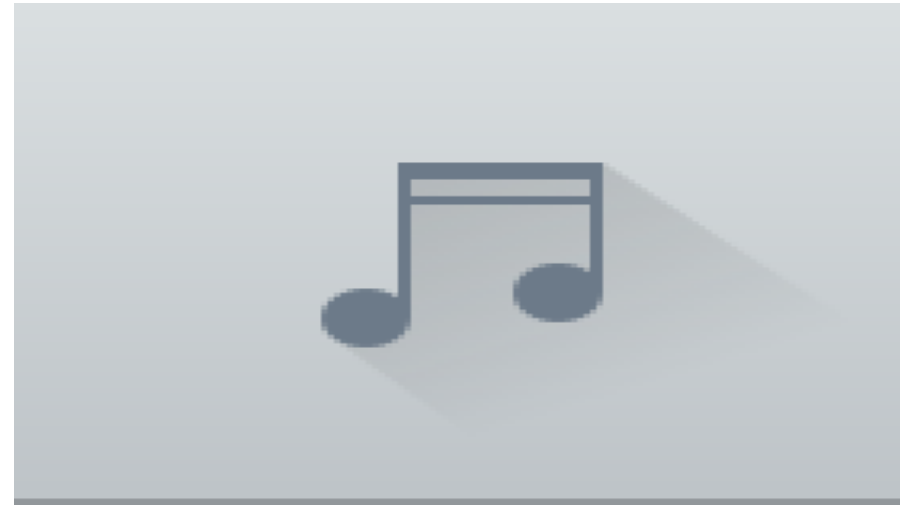
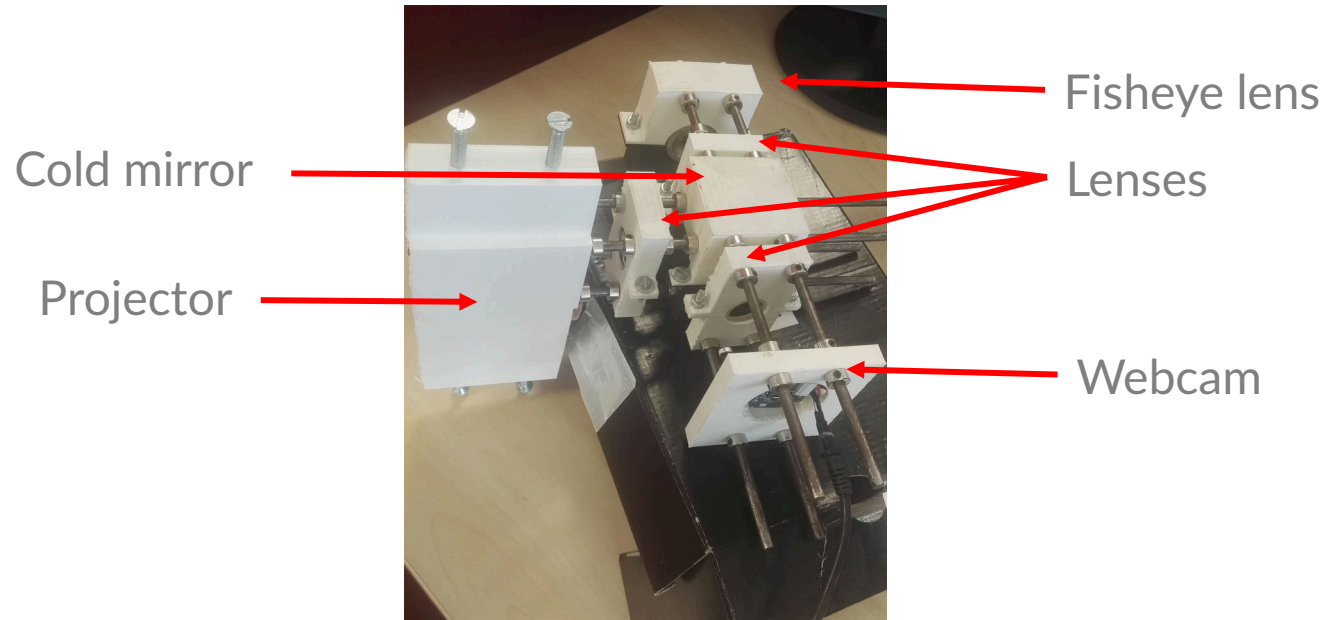



# Pictures and videos

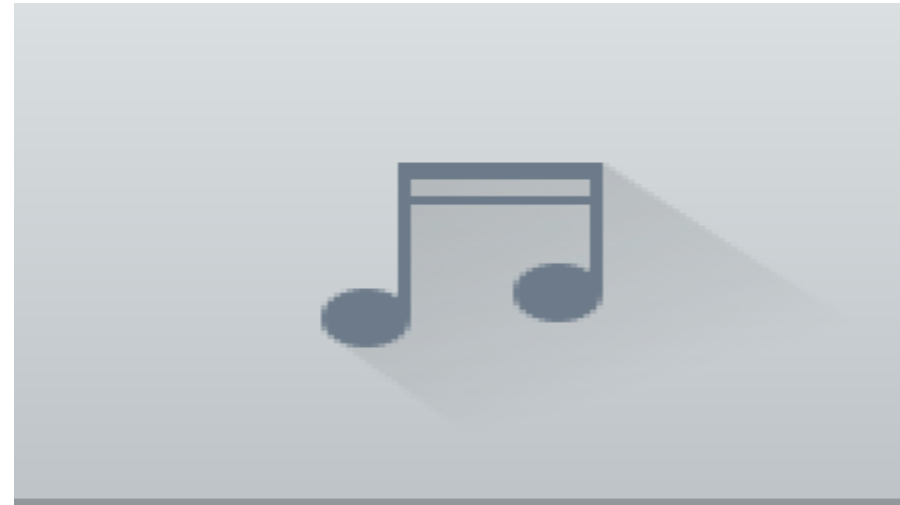
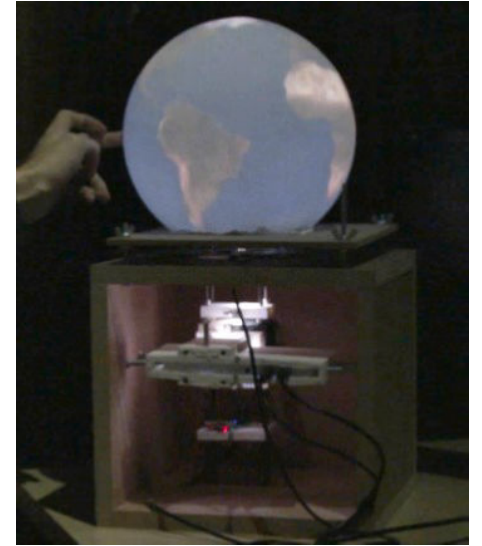
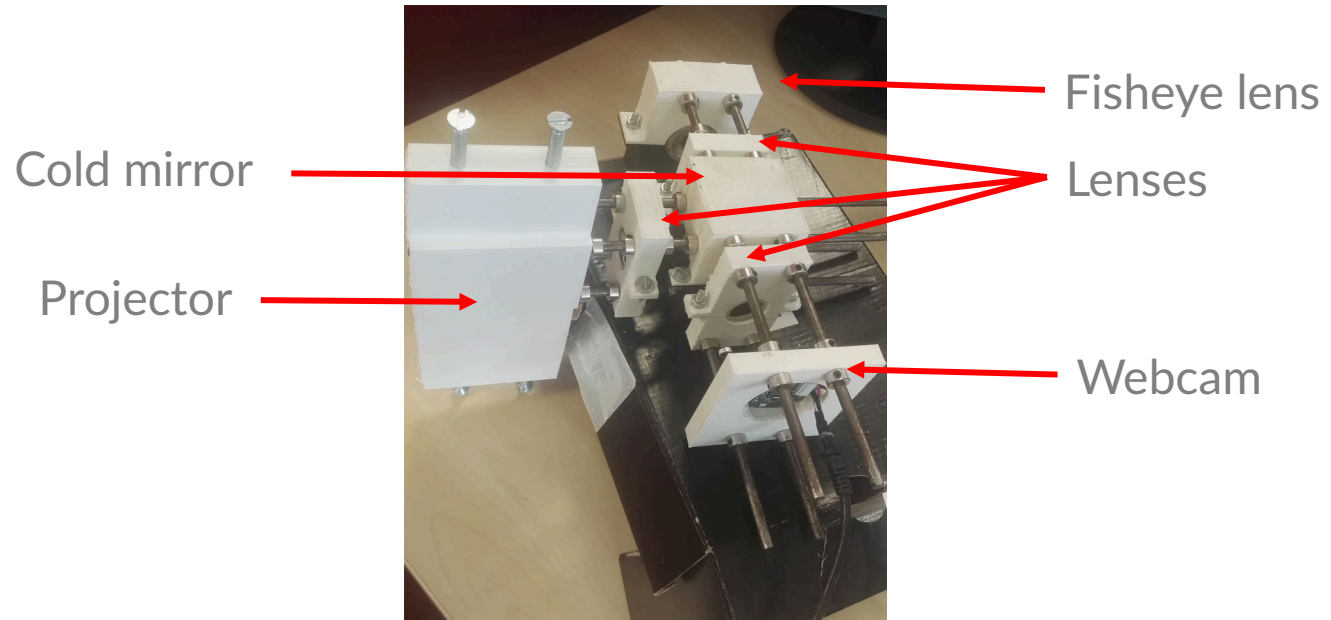

# Summary

- Multitouch spherical display without the need of custom shaped lenses
- LBS projector + Infrared finger tracking
- Optical system to cover the full sphere and maintain a sharp image
- Software corrections to compensate the cheap components
- Working prototype for less than \$600
- Approximative resolution : 620k pixels
- Low brightness

# Future work

## Anamorphic system

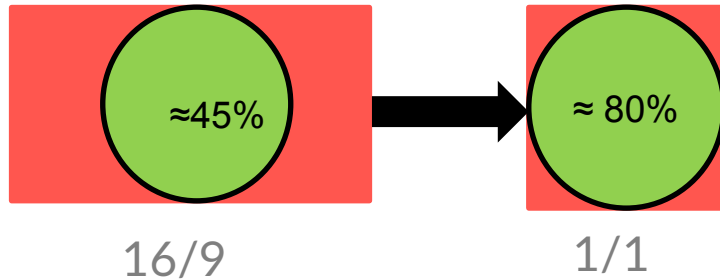

- Aspect ratio 1:1
- Increase brightness and resolution
- Examples : prism pair, cylindrical lenses...

## Frustrated total internal reflection

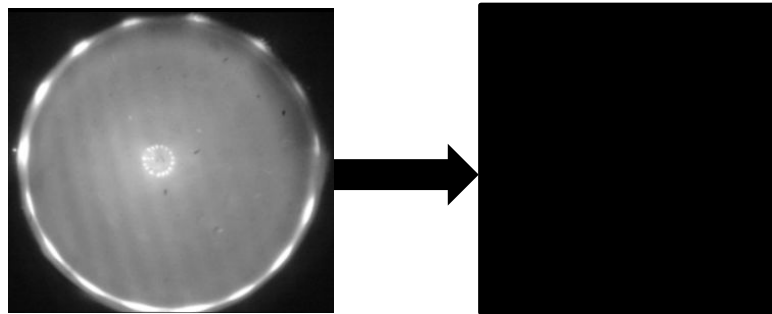
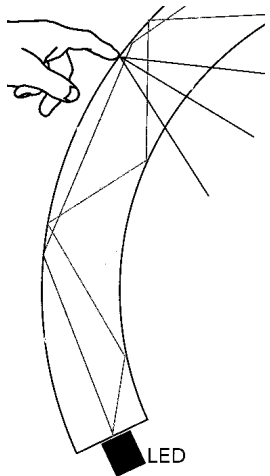

- Common for planar surfaces
- Compatible for spherical surfaces
- Darker background image

But :

- Transmissive surface vs. diffuse surface

Thanks!  
Questions?

Thomas Crespel  
thomas.crespel@inria.fr

