



HAL
open science

Understanding the Time-Dependent Effective Diffusion Coefficient Measured by Diffusion MRI: the Intra-Cellular Case

Housseem Haddar, Jing-Rebecca Li, Simona Schiavi

► **To cite this version:**

Housseem Haddar, Jing-Rebecca Li, Simona Schiavi. Understanding the Time-Dependent Effective Diffusion Coefficient Measured by Diffusion MRI: the Intra-Cellular Case. *SIAM Journal on Applied Mathematics*, 2017. hal-01421928

HAL Id: hal-01421928

<https://inria.hal.science/hal-01421928>

Submitted on 23 Dec 2016

HAL is a multi-disciplinary open access archive for the deposit and dissemination of scientific research documents, whether they are published or not. The documents may come from teaching and research institutions in France or abroad, or from public or private research centers.

L'archive ouverte pluridisciplinaire **HAL**, est destinée au dépôt et à la diffusion de documents scientifiques de niveau recherche, publiés ou non, émanant des établissements d'enseignement et de recherche français ou étrangers, des laboratoires publics ou privés.

1 **UNDERSTANDING THE TIME-DEPENDENT EFFECTIVE**
2 **DIFFUSION COEFFICIENT MEASURED BY DIFFUSION MRI: THE**
3 **INTRA-CELLULAR CASE***

4 HOUSSEM HADDAR[†], JING-REBECCA LI[†], AND SIMONA SCHIAVI[†]

5 **Abstract.** Diffusion Magnetic Resonance Imaging (dMRI) can be used to measure a time-
6 dependent effective diffusion coefficient that can in turn reveal information about the tissue geometry.
7 Recently a mathematical model for the time-dependent effective diffusion coefficient was obtained
8 using homogenization techniques after imposing a certain scaling relationship for the time, the bi-
9 ological cell membrane permeability, the diffusion-encoding magnetic field gradient strength, and a
10 periodicity length of the cellular geometry. With this choice of the scaling of the physical parameters,
11 the effective diffusion coefficient of the medium can be computed after solving a diffusion equation
12 subject to a time-dependent Neumann boundary condition, independently in the biological cells and
13 in the extra-cellular space. In this paper, we analyze this new model, which we call the H-*ADC*
14 model, in the case of finite domains, which is relevant to diffusion inside biological cells. We use both
15 the eigenfunction expansion and the single layer potential representation for the solution of the above
16 mentioned diffusion equation to obtain analytical expressions for the effective diffusion coefficient in
17 different diffusion time regimes. These expressions are validated using numerical simulations in two
18 dimensions.

19 **Key words.** Diffusion MRI; time-dependent *ADC*; homogenization; effective medium;

20 **AMS subject classifications.** 35B27, 35Q99, 65M32, 65Z05

21 **1. Introduction.** Diffusion Magnetic Resonance Imaging (dMRI) encodes water
22 displacement due to diffusion via the application of diffusion-encoding gradient pulses
23 and is a powerful tool to obtain information on the tissue microstructure. A major
24 application has been in detecting acute cerebral ischemia minutes after stroke [28, 42].
25 DMRI has been used to detect and differentiate a wide range of physiological and
26 pathological conditions in the brain, including tumors [25, 37, 40] and myelination
27 abnormalities (for a review, see [21]). It also has been used to study brain connectivity
28 (for a review, see [20]) and in functional imaging [22] as well as in cardiac applications
29 [5, 6, 35].

30 In particular, we are interested in an important quantity measured by dMRI
31 called the “Apparent Diffusion Coefficient” (*ADC*) which is based on a measure of the
32 mean diffusion displacement inside an imaging voxel. The mean squared displacment
33 of spins during a diffusion time t_D is defined as:

34 (1) $MSD(t_D) \equiv \frac{1}{\int_{\mathbf{x}_0} \rho(\mathbf{x}_0) d\mathbf{x}_0} \int_{\mathbf{x}_0} \int_{\mathbf{x}} \rho(\mathbf{x}_0) ((\mathbf{x} - \mathbf{x}_0) \cdot \mathbf{u}_{\mathbf{g}})^2 u(\mathbf{x}, \mathbf{x}_0, t_D) d\mathbf{x} d\mathbf{x}_0.$

35 where $u(\mathbf{x}, \mathbf{x}_0, t_D)$ is the proportion of spins starting at \mathbf{x}_0 when $t = 0$ ending up at
36 position \mathbf{x} after a time t_D , $\rho(\mathbf{x}_0)$ is the density of spins at \mathbf{x}_0 , and $\mathbf{u}_{\mathbf{g}}$ is a unit vector
37 in \mathbb{R}^3 ($\mathbf{u}_{\mathbf{g}}$ is called the diffusion-encoding direction). In the same vein, we can define
38 an effective diffusion coefficient in the direction $\mathbf{u}_{\mathbf{g}}$ by the following expression:

39 (2) $\frac{1}{2 t_D} MSD(t_D).$

*Submitted to the editors December, 10th 2016.

Funding: ...

[†]INRIA- CMAP, École Polytechnique, Paris-Saclay (houssem.haddar@inria.fr, jingrebecca.li@inria.fr, simona.schiavi@polytechnique.edu).

40 Since the mean squared displacement in a heterogeneous medium is not necessarily
 41 linear in t_D , effective diffusion coefficient typically depends on t_D .

42 The MSD can be measured by dMRI using a sequence of magnetic field gradient
 43 pulses (called a diffusion-encoding sequence). A commonly used sequence is the Pulse
 44 Gradient Spin Echo (PGSE) experiment [36]. In this paper, we will focus on the
 45 PGSE time profile to simplify the presentation.

46 The PGSE sequence contains two rectangular pulses of the diffusion-encoding
 47 gradient magnetic field $B_{\text{diff}} = g\mathbf{u}_g \cdot \mathbf{x}$, where g is the strength of the gradient and
 48 \mathbf{u}_g is the gradient direction. Each pulse has a duration δ , with the delay between the
 49 start of the two pulses denoted Δ , and there is also a radio-frequency (RF) pulse to
 affect a 180 degree spin reversal between the pulses (see Figure 1).

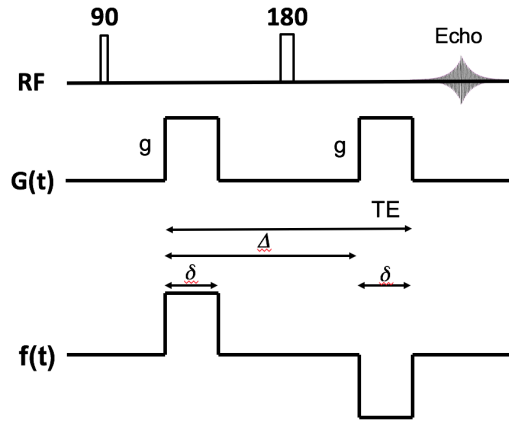

Fig. 1: The Pulsed Gradient Spin Echo (PGSE) sequence. The effective sequence time profile shown here takes into account the 180 degree pulse.

50

51 In the ideal case, where the pulse duration is very short compared to the delay
 52 between the pulses, $\delta \ll \Delta$, called the narrow pulse case, it is easy to relate the
 53 magnetization of spins to the diffusion propagator $u(\mathbf{x}, \mathbf{x}_0, t_D)$. Let us consider spins
 54 initially located at \mathbf{x}_0 . After the first pulse, the complex phase of these spins is
 55 $e^{i\delta\gamma\mathbf{g}\cdot\mathbf{x}_0}$, where $\gamma = 42.576$ MHz/Tesla is the gyro-magnetic ratio of the water proton.
 56 Because the gradient magnetic field is turned off after the first pulse, the spins move
 57 but the phase of the spins does not change. The phase remains $e^{i\delta\gamma\mathbf{g}\cdot\mathbf{x}_0}$, until the
 58 application of the RF pulse resulting in a 180 degree spin reversal. After the 180
 59 degree RF pulse, the complex phase becomes $e^{-i\delta\gamma\mathbf{g}\cdot\mathbf{x}_0}$. Again, spins move but the
 60 phase of the spins stays the same until the application of the second pulse, after which
 61 the complex phase due to spins ending up at position \mathbf{x}_f becomes $e^{i\delta\gamma\mathbf{g}\cdot(\mathbf{x}_f-\mathbf{x}_0)}$. So the
 62 magnetization at position \mathbf{x} and the echo time TE , which is the time that the MRI
 63 signal is acquired, some time after the end of the second pulse (i.e. $TE \geq \Delta + \delta$), is:

$$64 \quad (3) \quad M(\mathbf{x}, TE) \approx \int_{\mathbf{x}_0} \rho(\mathbf{x}_0) u(\mathbf{x}, \mathbf{x}_0, \Delta) e^{i\delta\gamma\mathbf{g}\cdot(\mathbf{x}-\mathbf{x}_0)} d\mathbf{x}_0,$$

65 where we used the assumption that $\delta \ll \Delta$. The dMRI signal S is the total water

66 proton magnetization in an imaging voxel V :

$$67 \quad (4) \quad S = \int_{\mathbf{x} \in V} M(\mathbf{x}, TE) d\mathbf{x}.$$

68 Because the diffusion displacement is usually much shorter than the size of the
69 imaging voxel size we can ignore spins that enter and leave the voxel during the signal
70 acquisition and thus take domain of integration in Eq. (4) to be \mathbb{R}^3 . Using properties
71 of the Fourier transform, we obtain

$$72 \quad (5) \quad \left. \frac{\partial \frac{S}{S_0}}{\partial (\delta\gamma g)^2} \right|_{\delta\gamma g=0} \approx MSD(\Delta),$$

73 in the case of the narrow pulse PGSE sequence, where S_0 is the signal at $g = 0$ (a
74 derivation of this statement can be found in [23]).

75 Without the narrow pulse assumption, Eq. (3) does not hold exactly. Rather,
76 $M(\mathbf{x}, t)$ is governed by the Bloch-Torrey equation, which is a complex-valued diffusive
77 PDE:

$$78 \quad (6) \quad \begin{cases} \frac{\partial}{\partial t} M(\mathbf{x}, t) = -\nu\gamma g \mathbf{u}_{\mathbf{g}} \cdot \mathbf{x} f(t) M(\mathbf{x}, t) + \text{div}(\mathcal{D}_0(\mathbf{x}) \nabla M(\mathbf{x}, t)) & \text{in } \bigcup \Omega_j \times [0, TE] \\ \llbracket \mathcal{D}_0 \nabla M \cdot \nu \rrbracket_{\Gamma_{ij}} = 0 & \text{on } \Gamma_{ij} \times [0, TE] \\ \mathcal{D}_0 \nabla M \cdot \nu|_{\Gamma_{ij}} = \kappa \llbracket M \rrbracket_{\Gamma_{ij}} & \text{on } \Gamma_{ij} \times [0, TE] \\ M(\cdot, 0) = \rho & \text{in } \bigcup \Omega_j \end{cases}$$

79 where Ω_0 is the extra-cellular space and each of Ω_j , $j = 1, \dots, N$, is a biological cell.
80 The vector ν is the exterior normal to the biological cells; $\llbracket \cdot \rrbracket_{\Gamma_{ij}}$, $i, j = 0, \dots, N$, $i \neq j$,
81 is the jump (the limit value in compartment i minus the limit value in compartment j)
82 on Γ_{ij} , the interface between Ω_i and Ω_j ; κ is the membrane permeability coefficient;
83 ι is the imaginary unit. The function $f(t)$ gives the normalized time profile of the
84 diffusion-encoding magnetic field gradient pulses. For the classic Pulsed Gradient
85 Spin Echo (PGSE) sequence [36], simplified to include only the parameters relevant
86 to diffusion (the imaging gradients are ignored),

$$87 \quad (7) \quad f(t) = \begin{cases} 1 & t_s < t \leq t_s + \delta, \\ 0 & t_s + \delta < t \leq t_s + \Delta, \\ -1 & t_s + \Delta < t \leq t_s + \Delta + \delta, \\ 0 & \text{elsewhere,} \end{cases}$$

88 where t_s is the start of the first pulse and we made $f(t)$ negative in the second pulse
89 to include the effect of the 180 degree spin reversal between the pulses. For simplicity,
90 since t_s does not play a role in the results of this paper, we set $t_s \rightarrow 0$. For the same
91 reason, we set $TE = \delta + \Delta$ in this paper.

92 We note that the Bloch-Torrey equation needs to be supplemented by additional
93 boundary conditions on the sides of the imaging voxel. For example, periodic bound-
94 ary conditions on the boundary of the voxel would be an acceptable choice.

95 In the case of unrestricted diffusion in a homogeneous medium with a diffusion
96 coefficient \mathcal{D}_0 , the integral of the solution of the Bloch-Torrey equation, in other
97 words, the total magnetization, takes the following exponential form [4, 16]:

$$98 \quad (8) \quad S = S_0 e^{-\mathcal{D}_0 b},$$

99 with the b -value defined as:

$$100 \quad (9) \quad b \equiv \gamma^2 g^2 \int_0^{TE} F(t)^2 dt,$$

101 where

$$102 \quad (10) \quad F(t) \equiv \int_0^t f(s) ds.$$

103 In particular, for the PGSE sequence,

$$104 \quad (11) \quad F(t) = \begin{cases} t & t_s < t \leq t_s + \delta, \\ \delta & t_s + \delta < t \leq t_s + \Delta, \\ \Delta + \delta - t & t_s + \Delta < t \leq t_s + \Delta + \delta, \\ 0 & \text{elsewhere.} \end{cases}$$

105 To adapt the definition of the effective diffusion coefficient to the non-narrow
106 pulse case, we make the following mathematical definition:

$$107 \quad (12) \quad D_{\mathbf{u}_g}^{\text{eff}} \equiv - \frac{1}{\gamma^2 \int_0^{TE} F(t)^2 dt} \frac{\partial}{\partial g^2} \ln \left(\frac{S}{S_0} \right) \Bigg|_{g=0}.$$

108 In the dMRI community, the above quantity is fitted using the experimental MRI
109 signal at several b values and the obtained value is called the ‘‘apparent diffusion
110 coefficient’’ (ADC). The ADC is widely used medical applications, for instance, ADC
111 maps of brain have been used to identify tumours (see [21, 41]). The $D_{\mathbf{u}_g}^{\text{eff}}$ defined
112 in the above formula depends on the gradient direction \mathbf{u}_g and the temporal profile
113 $f(t)$ but not on the gradient amplitude. In this paper, with the phrase ‘‘diffusion
114 time-dependent’’ we actually mean dependent on Δ and δ .

115 The motivation of our work is the experimentally observed phenomenon (see [33]
116 and the references contained there) that the ADC depends on Δ (and δ in the non-
117 narrow pulse case), leading to the need to characterize the time-dependent ADC in
118 terms of tissue-related quantities over a wide range of diffusion time regimes. The
119 ultimate goal is of course the estimation of these tissue-related quantities from the
120 measured dMRI signal.

121 In this paper, we focus on the case of finite domains, where the membrane per-
122 meability is small enough to have negligible effect on the effective diffusion coefficient,
123 which is related to the first order moment of the dMRI signal in the b -value (Eq. 12).
124 We note that this does not exclude the permeability from having an effect on the
125 higher order moments of the signal. For the case where the permeability does affect
126 the $D_{\mathbf{u}_g}^{\text{eff}}$, the analysis is more difficult and we refer the reader to [7, 15, 19, 38, 39]
127 for results on periodic media and to [3, 8, 30, 31, 32] on more general heterogeneous
128 media, not necessarily periodic.

129 Now we summarize some existing results concerning the effective diffusion coeffi-
130 cient for finite domains where the membrane permeability is negligible. In the short
131 time regime, the effective diffusion coefficient is reduced from the free diffusion coeffi-
132 cient \mathcal{D}_0 by the presence of the cell membranes that affects only the molecules in the
133 adjacent layer. The thickness of this layer is of the order of the diffusion length $\sqrt{\mathcal{D}_0 t}$
134 [17], where \mathcal{D}_0 is the bulk diffusion coefficient. Calculations in [26, 27] show

$$135 \quad (13) \quad D_{\text{short}}^{\text{eff}}(t) = \mathcal{D}_0 \left(1 - \frac{4}{3d\sqrt{\pi}} \frac{S}{V} \sqrt{\mathcal{D}_0 t} \right),$$

136 where d is the spatial dimension and S/V is the surface to volume ratio. This result
 137 was extended to include higher order terms accounting for permeable membranes,
 138 surface relaxation and mean curvature [18, 30]. It was also shown that, in the case of
 139 anisotropic media subjected to a linear gradient with direction \mathbf{u}_g , one should replace
 140 $\frac{S}{dV}$ above by $\frac{\int_{\partial\Omega}(\mathbf{u}_g \cdot \nu)^2 d\mathbf{x}}{|\Omega|}$ [1, 9]. In the long time limit, the spins explore the whole
 141 available space of the finite domain and then their mean square displacement saturates
 142 while the effective diffusion coefficient decreases as Δ increases. For an isolated cell
 143 of a typical size R the diffusion becomes Gaussian as was shown in [29, 34]. In the
 144 case of the PGSE sequence in the narrow pulse limit one gets

145 (14)
$$D_{long}^{eff}(\Delta) \approx C \frac{R^2}{\Delta},$$

146 where C is a geometrical constant (for example, $C = 1/4$ for the reflecting cylinder
 147 and $C = 1/12$ for a 1D configuration [4, 9]).

148 Finally, an approach that is closely related to the work of this paper is the “ma-
 149 trix formalism” approach used to describe restricted diffusion in bounded domains[2,
 150 9, 10, 11]. There one considers the applied diffusion-encoding magnetic field as a per-
 151 turbation of the Laplace operator and the magnetization is decomposed on the basis
 152 of Laplacian eigenfunctions.

153 In contrast to the “matrix formalism” approach, the homogeneous model [14]
 154 which we call the H-ADC model and which is the focus of this paper, was derived
 155 using a certain scaling of the membrane permeability with respect to other physical
 156 parameters and thus is not limited to impermeable domains. Our derivation of the
 157 H-ADC model justifies neglecting the membrane permeability for the choice of scal-
 158 ing that we have made. In addition, since we have formulated the time-dependent
 159 effective diffusion coefficient as the solution of a diffusion equation rather than di-
 160 rectly in the eigenfunction basis, we have the freedom to analyze the solution of the
 161 resulting diffusion equation using both the eigenfunction representation as well as the
 162 layer potential representation according the relevant time regime under consideration.
 163 Finally, we note that we preferred the term “apparent” to the term “effective” in nam-
 164 ing the H-ADC model due to the more common usage of the term ADC in the MRI
 165 community.

166 This paper is organized as follows. In Section 2 we describe the H-ADC model
 167 derived in [14]. In Section 3 we represent the solution of the relevant diffusion equa-
 168 tion of the H-ADC model using the eigenfunction basis as well as by single layer
 169 potentials and discuss the regime where each representation is advantageous. In
 170 Section 4 we provide formulas for the effective diffusion coefficient that is averaged
 171 over diffusion-encoding gradient directions that are uniformly distributed in the unit
 172 sphere. In Section 5 we validate our analytical results with numerical simulations on
 173 two-dimensional geometries. Section 6 contains our conclusions.

174 **2. Effective diffusion coefficient in finite domains.** In a previous work [14],
 175 we obtained an homogenized model by starting from the Bloch-Torrey equation using
 176 the following scaling relationship between the time (Δ and δ), the biological cell
 177 membrane permeability (κ), the diffusion-encoding magnetic field gradient strength
 178 (g), and a periodicity length of the cellular geometry (L):

179
$$L = O(\epsilon), \kappa = O(\epsilon), g = O(\epsilon^{-2}), \{\Delta, \delta\} = O(\epsilon^2),$$

180 where ϵ is a non-dimensional parameter. It was shown that with this choice, there
 181 is no coupling between the different geometrical compartments in the g^2 term which

182 gives rise to the effective diffusion coefficient. The total effective diffusion coefficient
 183 is the sum of the effective diffusion coefficient in each geometrical compartment
 184 weighted by its volume fraction. Thus, in this paper we are justified in considering
 185 each compartment separately.

186 According to [14], with the definitions of $F(t)$ given in (11), the effective diffusion
 187 coefficient in the compartment Ω can be obtained in the following way:

$$188 \quad (15) \quad D_{\mathbf{u}_g}^{\text{eff}} = \mathcal{D}_0 - \frac{\mathcal{D}_0}{\int_0^{TE} F(t)^2 dt} \int_0^{TE} F(t) h(t) dt,$$

189 where

$$190 \quad (16) \quad h(t) = \frac{1}{|\Omega|} \int_{\Omega} \mathbf{u}_g \cdot \nabla \omega(\mathbf{x}, t)$$

191 is a quantity related to the directional gradient of a function ω that is the solution
 192 of the homogeneous diffusion equation with Neumann boundary condition and zero
 193 initial condition:

$$194 \quad (17) \quad \begin{aligned} \frac{\partial}{\partial t} \omega(\mathbf{x}, t) - \nabla \cdot (\mathcal{D}_0 \nabla \omega(\mathbf{x}, t)) &= 0, & \mathbf{x} \in \Omega, \\ \mathcal{D}_0 \nabla \omega(\mathbf{x}, t) \cdot \nu(\mathbf{x}) &= \mathcal{D}_0 F(t) \mathbf{u}_g \cdot \nu(\mathbf{x}), & \mathbf{x} \in \partial\Omega, \\ \omega(\mathbf{x}, t) &= 0, & \mathbf{x} \in \Omega, \end{aligned}$$

195 ν is the outward normal and $t \in [0, TE]$. We can see that if $h(t)$ is close to $F(t)$, then
 196 $D_{\mathbf{u}_g}^{\text{eff}}$ is close to 0. The above set of equations, (15)-(17), comprise the homogenized
 197 model that we call the H-ADC model.

198 In our previous work [14], we imposed periodic boundary conditions on the bound-
 199 ary of the voxel. In this paper, we are interested in analyzing (15)-(17) for spatially
 200 finite compartments, which is relevant to diffusion inside biological cells. It will not
 201 be necessary to impose periodic boundary conditions on the sides of the imaging voxel
 202 if we consider only cells that do not touch the sides.

203 **3. Solution of the model.** Defining the right hand side of the Neumann bound-
 204 ary condition as

$$205 \quad (18) \quad \beta(\mathbf{y}, t) := \mathcal{D}_0 F(t) \mathbf{u}_g \cdot \nu(\mathbf{y}),$$

206 we will use the following two equivalent expressions for $h(t)$:

$$207 \quad (19) \quad h(t) = \frac{1}{|\Omega|} \int_{\Omega} \mathbf{u}_g \cdot \nabla \omega(\mathbf{x}, t) d\mathbf{x} = \frac{1}{|\Omega|} \int_{\Gamma} \omega(\mathbf{y}, t) (\mathbf{u}_g \cdot \nu(\mathbf{y})) ds_{\mathbf{y}},$$

208 where the second expression can be obtained by applying the divergence theorem to
 209 (16). We observe that the first expression uses values of the gradient of ω inside
 210 the domain while the second uses the values of ω on the boundary. Each expression
 211 will have advantages depending on whether we use the eigenfunctions of the Laplace
 212 operator or layer potentials to represent ω .

213 **3.1. Eigenfunctions representation.** Writing ω as the sum

$$214 \quad (20) \quad \omega(\mathbf{x}, t) = \tilde{\omega}(\mathbf{x}, t) + F(t) \mathbf{x} \cdot \mathbf{u}_g, \mathbf{x} \in \Omega, t \in [0, TE]$$

215 where $\tilde{\omega}(\mathbf{x}, t)$ satisfied the diffusion equation with a forcing term and homogeneous
 216 boundary condition:

$$217 \quad (21) \quad \frac{\partial}{\partial t} \tilde{\omega}(\mathbf{x}, t) - \nabla \cdot (\mathcal{D}_0 \nabla \tilde{\omega}(\mathbf{x}, t)) = -f(t) \mathbf{x} \cdot \mathbf{u}_g, \quad \mathbf{x} \in \Omega, t \in [0, TE],$$

$$218 \quad (22) \quad \mathcal{D}_0 \nabla \tilde{\omega}(\mathbf{x}, t) \cdot \nu(\mathbf{x}) = 0, \quad \mathbf{x} \in \Gamma, t \in [0, TE],$$

$$219 \quad (23) \quad \tilde{\omega}(\mathbf{x}, t) = 0, \quad \mathbf{x} \in \Omega,$$

221 it is well-known that $\tilde{\omega}(\mathbf{x}, t)$ can be expanded in the basis of Laplace eigenfunctions.
 222 Let $\phi_n(\mathbf{x})$ and λ_n be the L^2 normalized eigenfunctions and eigenvalues associated to
 223 the Laplace operator with homogeneous Neumann boundary conditions:

$$224 \quad -\nabla \mathcal{D}_0 (\nabla \phi_n(\mathbf{x})) = \lambda_n \phi_n(\mathbf{x}), \quad \mathbf{x} \in \Omega,$$

$$225 \quad \mathcal{D}_0 \nabla \phi_n(\mathbf{x}) \cdot \nu(\mathbf{x}) = 0, \quad \mathbf{x} \in \Gamma.$$

227 We can write $\tilde{\omega}(\mathbf{x}, t)$ in the basis of the eigenfunctions as

$$228 \quad (24) \quad \tilde{\omega}(\mathbf{x}, t) = -a_0 \phi_0(\mathbf{x}) F(t) + \sum_{n=1}^{\infty} (-a_n) \phi_n(\mathbf{x}) \int_0^t e^{-\mathcal{D}_0 \lambda_n (t-s)} f(s) ds,$$

229 where the coefficients are

$$230 \quad (25) \quad a_0 = \frac{1}{\sqrt{|\Omega|}} \int_{\Omega} \mathbf{x} \cdot \mathbf{u}_g d\mathbf{x}, \quad a_n = \int_{\Omega} \mathbf{x} \cdot \mathbf{u}_g \phi_n(\mathbf{x}) d\mathbf{x},$$

232 which coincide with the first moments of the eigenfunctions in the \mathbf{u}_g direction.

233 Finally, the solution to the diffusion equation is

$$234 \quad (26) \quad \omega(\mathbf{x}, t) = \left(\mathbf{x} \cdot \mathbf{u}_g - \frac{1}{\sqrt{|\Omega|}} a_0 \right) F(t) + \sum_{n=1}^{\infty} (-a_n) \phi_n(\mathbf{x}) \int_0^t e^{-\mathcal{D}_0 \lambda_n (t-s)} f(s) ds$$

235 and using properties of the eigenfunctions:

$$236 \quad (27) \quad \int_{\Omega} \phi_n(\mathbf{x}) d\mathbf{x} = \begin{cases} \sqrt{|\Omega|}, & n = 0 \\ 0, & n \geq 1, \end{cases}$$

237 and the divergence theorem:

$$238 \quad (28) \quad \int_{\Omega} \lambda_n \phi_n(\mathbf{u}_g \cdot \mathbf{x}) d\mathbf{x} = \int_{\Omega} \nabla \phi_n(\mathbf{x}) \cdot \mathbf{u}_g d\mathbf{x} - \int_{\Gamma} \mathcal{D}_0 \nabla \phi_n(\mathbf{x}) \cdot \nu \mathbf{u}_g \cdot \nu ds_{\mathbf{x}} = \int_{\Omega} \nabla \phi_n(\mathbf{x}) \cdot \mathbf{u}_g d\mathbf{x}$$

239 we obtain

$$240 \quad (29) \quad h(t) = F(t) + \sum_{n=1}^{\infty} -\frac{(a_n)^2 \lambda_n}{|\Omega|} \int_0^t e^{-\mathcal{D}_0 \lambda_n (t-s)} f(s) ds.$$

241 This leads to the final formula:

$$242 \quad (30) \quad D_{\mathbf{u}_g}^{\text{eff}} = \sum_{n=1}^{\infty} \frac{(a_n)^2 \mathcal{D}_0 \lambda_n}{|\Omega| \int_0^{TE} F^2(t) dt} \int_0^{TE} F(t) \left(\int_0^t e^{-\mathcal{D}_0 \lambda_n (t-s)} f(s) ds \right) dt.$$

243 We remark that this formula is the same as the one obtained with the matrix formalism
 244 in [9]. In particular, if we consider PGSE sequence, we can rewrite (15) using the
 245 contribution of each of the three intervals as
 (31)

$$246 \quad D_{\mathbf{u}_g}^{\text{eff}} = \mathcal{D}_0 - \left(\underbrace{\frac{\mathcal{D}_0}{A} \int_0^\delta t h(t) dt}_I + \underbrace{\frac{\mathcal{D}_0}{A} \int_\delta^\Delta \delta h(t) dt}_{II} + \underbrace{\frac{\mathcal{D}_0}{A} \int_\Delta^{\Delta+\delta} (\Delta + \delta - t) h(t) dt}_{III} \right),$$

247 where

$$248 \quad (32) \quad A = \int_0^{TE} F^2(t) dt = \delta^2 \left(\Delta - \frac{\delta}{3} \right),$$

249 and in the first pulse

$$250 \quad (33) \quad I = \frac{\mathcal{D}_0 \delta^3}{3A} + \frac{1}{|\Omega|A} \sum_{n=1}^{\infty} (a_n)^2 \left(-\frac{\delta^2}{2} - \frac{\delta e^{-\mathcal{D}_0 \lambda_n \delta}}{\mathcal{D}_0 \lambda_n} - \frac{e^{-\mathcal{D}_0 \lambda_n \delta} - 1}{(\mathcal{D}_0 \lambda_n)^2} \right),$$

252 between the pulses

$$253 \quad (34) \quad II = \frac{\mathcal{D}_0 \delta^2 (\Delta - \delta)}{A} + \frac{1}{|\Omega|A} \sum_{n=1}^{\infty} \frac{-\delta (a_n)^2}{\mathcal{D}_0 \lambda_n} \left(e^{-\mathcal{D}_0 \lambda_n \Delta} - e^{-\mathcal{D}_0 \lambda_n (\Delta - \delta)} - e^{-\mathcal{D}_0 \lambda_n \delta} + 1 \right),$$

255 and in the second pulse

$$257 \quad (35) \quad III = \frac{\mathcal{D}_0 \delta^3}{3A} + \sum_{n=1}^{\infty} \frac{-(a_n)^2}{\mathcal{D}_0 \lambda_n A |\Omega|} \left(\delta - \frac{\delta^2 \mathcal{D}_0 \lambda_n}{2} - \delta e^{-\mathcal{D}_0 \lambda_n \Delta} + \delta e^{-\mathcal{D}_0 \lambda_n (\Delta - \delta)} \right. \\ \left. + \frac{2e^{-\mathcal{D}_0 \lambda_n \Delta} - 1 + e^{-\mathcal{D}_0 \lambda_n \delta} - e^{-\mathcal{D}_0 \lambda_n (\Delta + \delta)} - e^{-\mathcal{D}_0 \lambda_n (\Delta - \delta)}}{\mathcal{D}_0 \lambda_n} \right).$$

260 In the end, we obtain

$$262 \quad (36) \quad D_{\mathbf{u}_g}^{\text{eff}} = \sum_{n=1}^{\infty} \frac{-(a_n)^2}{\mathcal{D}_0^2 \lambda_n^2 \delta^2 \left(\Delta - \frac{\delta}{3} \right) |\Omega|} \left[e^{-\mathcal{D}_0 \lambda_n (\Delta + \delta)} + e^{-\mathcal{D}_0 \lambda_n (\Delta - \delta)} \right. \\ \left. - 2 \left(\mathcal{D}_0 \lambda_n \delta + e^{-\mathcal{D}_0 \lambda_n \delta} + e^{-\mathcal{D}_0 \lambda_n \Delta} - 1 \right) \right].$$

265 In the narrow pulse case ($\delta \ll \Delta$), we obtain

$$266 \quad (37) \quad D_{\mathbf{u}_g}^{\text{eff}} \approx \sum_{n=1}^{\infty} \frac{(a_n)^2}{\Delta} (1 - e^{-\mathcal{D}_0 \lambda_n \Delta}),$$

267 which confirms that $D_{\mathbf{u}_g}^{\text{eff}}$ approach its long time limit as proportional to $1/\Delta$ inside
 268 finite domains. In particular, for a 1D configuration of length L , $a_1 = \frac{L^2}{12}$ and for a
 269 reflecting cylinder of radius R , $a_1 = \frac{R^2}{4}$, which confirm the results in [4, 9].

270 **3.2. Layer potential representation.** The solution of the diffusion equation
 271 can be also represented using layer potentials [13]. This representation is more efficient
 272 than the eigenfunction representation at short diffusion times. Since the PDE has a
 273 Neumann boundary condition, we choose to represent the solution $\omega(\mathbf{x}, t) = S[\mu](\mathbf{x}, t)$
 274 as a single layer potential with a density μ defined on Γ ,

$$275 \quad (38) \quad S[\mu](\mathbf{x}, t) = \int_0^t \int_{\Gamma} \mathcal{D}_0 G(\mathbf{x} - \mathbf{y}, t - \tau) \mu(\mathbf{y}, \tau) ds_{\mathbf{y}} d\tau,$$

276 where $G(\mathbf{x}, t)$ is the fundamental solution of the heat equation in free space given by

$$277 \quad (39) \quad G(\mathbf{x}, t) = (4\pi\mathcal{D}_0 t)^{-d/2} \exp\left(\frac{-\|\mathbf{x}\|^2}{4\mathcal{D}_0 t}\right)$$

278 and d is the space dimension. At short times, there is an unavoidable square root
 279 singularity in t in the single layer potential, therefore in what follows, we separate out
 280 the integrand in (38) in the following way,

$$281 \quad (40) \quad S[\mu](\mathbf{x}, t) = \int_0^t \frac{1}{\sqrt{4\mathcal{D}_0\pi(t-\tau)}} B_S[\mu](\mathbf{x}, t, \tau) d\tau,$$

282 where

$$283 \quad (41) \quad B_S[\mu](\mathbf{x}, t, \tau) := \int_{\Gamma} \mathcal{D}_0 \sqrt{4\mathcal{D}_0\pi(t-\tau)} G(\mathbf{x} - \mathbf{y}, t - \tau) \mu(\mathbf{y}, \tau) ds_{\mathbf{y}}$$

284 is analytic in time if μ is. The single layer potential satisfies

$$285 \quad (42) \quad \frac{\partial}{\partial t} S[\mu](\mathbf{x}, t) - \nabla(\mathcal{D}_0 \nabla S[\mu](\mathbf{x}, t)) = 0, \quad \mathbf{x} \in \Omega, t \in [0, TE],$$

$$286 \quad (43) \quad S[\mu](\mathbf{x}, 0) = 0, \quad \mathbf{x} \in \Omega.$$

288 Then the density μ is chosen to be a causal function and is determined by imposing
 289 the Neumann boundary conditions:

$$290 \quad \lim_{\mathbf{x} \rightarrow \mathbf{x}^0 \in \Gamma} \mathcal{D}_0 \nabla S[\mu](\mathbf{x}, t) \cdot \nu(\mathbf{x}) = \beta(\mathbf{x}^0, t), \quad \mathbf{x}^0 \in \Gamma, t \in [0, TE],$$

291 where $\beta(\mathbf{x}^0, t)$ is defined in (18). Using the jump properties of the traces of double
 292 layer potentials, the integral equation to be solved for μ is then the following:

$$293 \quad (44) \quad \frac{\mathcal{D}_0}{2} \mu(\mathbf{x}^0, t) + \mathcal{D}_0 K^*[\mu](\mathbf{x}^0, t) = \beta(\mathbf{x}^0, t), \quad \mathbf{x}^0 \in \Gamma, t \in [0, TE],$$

294 where

$$295 \quad (45) \quad K^*[\mu](\mathbf{x}^0, t) = \int_0^t \frac{1}{\sqrt{4\pi\mathcal{D}_0(t-\tau)}} B_K[\mu](\mathbf{x}^0, t, \tau) d\tau,$$

297 with

$$298 \quad (46) \quad B_K[\mu](\mathbf{x}^0, t, \tau) \equiv \int_{\Gamma} \frac{-2(\mathbf{x}^0 - \mathbf{y}) \cdot \nu(\mathbf{y})}{4\mathcal{D}_0(t-\tau)} \mathcal{D}_0 \sqrt{4\pi\mathcal{D}_0(t-\tau)} G(\mathbf{x}^0 - \mathbf{y}, t - \tau) \mu(\mathbf{y}, \tau) ds_{\mathbf{y}}$$

331 and for the operator K^* it was shown that:

(53)

$$\begin{aligned}
 B_K[\mu](\mathbf{x}^0, t, \tau) &= \frac{\gamma_{ss}(\mathbf{x}^0)}{2} \mu(\mathbf{x}^0, t) + \frac{1}{8} \left[16\gamma_{sss}(\mathbf{x}^0) \mu_s(\mathbf{x}^0, t) + 12\gamma_{ss}(\mathbf{x}^0) \mu_{ss}(\mathbf{x}^0, t) \right. \\
 &+ 4\gamma_{ss}(\mathbf{x}^0) \mu_t(\mathbf{x}^0, t) + (6\gamma_{ssss}(\mathbf{x}^0) - 15\gamma_{ss}(\mathbf{x}^0)^3) \mu(\mathbf{x}^0, t) \left. \right] (t - \tau) \\
 &+ O((t - \tau)^2).
 \end{aligned}$$

333 Specifically γ_{ss} is the curvature of Γ at the point \mathbf{x}^0 and in what follows we will
 334 indicate it as $k(\mathbf{x}^0)$. In three dimensions, it should be easy to see that the constant
 335 term in $B_S[\mu](\mathbf{x}^0, t, \tau)$ would not change, and the constant term in $B_K[\mu](\mathbf{x}^0, t, \tau)$
 336 would contain spatial derivatives on a two dimensional manifold.

337 For the PGSE sequence, $\beta(\mathbf{x}^0, t)$ assumes the following three expressions in the
 338 three time intervals:

$$(54) \quad \beta(\mathbf{x}^0, t) = \mathcal{D}_0 \mathbf{u}_g \cdot \nu(\mathbf{x}^0) \begin{cases} t & 0 < t \leq \delta, \\ \delta & \delta < t \leq \Delta, \\ \Delta + \delta - t & \Delta < t \leq \Delta + \delta. \end{cases}$$

340 First, using the definition (40) and the result (52) we obtain

$$\begin{aligned}
 S \left[\frac{2}{\mathcal{D}_0} \beta \right] (\mathbf{x}^0, t) &= \frac{4(\mathcal{D}_0)^{1/2}}{3\sqrt{\pi}} \mathbf{u}_g \cdot \nu(\mathbf{x}^0) \begin{cases} t^{3/2} \\ t^{3/2} - (t - \delta)^{3/2} \\ t^{3/2} - (t - \delta)^{3/2} - (t - \Delta)^{3/2} \end{cases} \\
 (55) \quad &+ O \begin{cases} \left(t^{5/2} \right) & \text{if } 0 < t \leq \delta, \\ \left(t^{5/2} - (t - \delta)^{5/2} \right) & \text{if } \delta < t \leq \Delta, \\ \left(t^{5/2} - (t - \delta)^{5/2} - (t - \Delta)^{5/2} \right) & \text{if } \Delta < t \leq \Delta + \delta. \end{cases}
 \end{aligned}$$

342 Similarly, using the definition (45) and the result (53) we obtain

$$(56) \quad K^*[\beta](\mathbf{x}^0, t) = \alpha_1(\mathbf{x}_0) \alpha_2(t) + O(\alpha_3(t))$$

344 where

$$\begin{aligned}
 \alpha_1(\mathbf{x}_0) &= \frac{(\mathcal{D}_0)^{3/2} k(\mathbf{x}^0)}{3\sqrt{\pi}} (\mathbf{u}_g \cdot \nu(\mathbf{x}^0)), \\
 \alpha_2(t) &= \begin{cases} t^{3/2} & \text{if } 0 < t \leq \delta, \\ t^{3/2} - (t - \delta)^{3/2} & \text{if } \delta < t \leq \Delta, \\ t^{3/2} - (t - \delta)^{3/2} - (t - \Delta)^{3/2} & \text{if } \Delta < t \leq \Delta + \delta, \end{cases} \\
 (57) \quad \alpha_3(t) &= \begin{cases} t^{5/2} & \text{if } 0 < t \leq \delta, \\ t^{5/2} - (t - \delta)^{5/2} & \text{if } \delta < t \leq \Delta, \\ t^{5/2} - (t - \delta)^{5/2} - (t - \Delta)^{5/2} & \text{if } \Delta < t \leq \Delta + \delta. \end{cases}
 \end{aligned}$$

346 To compute $S \left[-\frac{4}{\mathcal{D}_0} K^*[\beta] \right] (\mathbf{x}^0, t)$, we first observe that $S \left[-\frac{4}{\mathcal{D}_0} K^*[\beta] \right] (\mathbf{x}^0, t) = -\frac{4}{\mathcal{D}_0} S [K^*[\beta]] (\mathbf{x}^0, t)$.

347 Moreover, to compute $S [K^*[\beta]] (\mathbf{x}^0, t)$ we cannot use the result (52) because α_2 and

348 α_3 do not have a Taylor expansion in t . Following the idea in [12], we explicitly
 349 compute the lowest order terms of $S[K^*[\beta]](\mathbf{x}^0, t)$ in two dimensions by

$$350 \quad (58) \quad S[K^*[\beta]](\mathbf{x}_0, t) = \int_0^t \frac{1}{\sqrt{4\pi\mathcal{D}_0(t-\tau)}} B_S[K^*[\beta]](\mathbf{x}_0, t, \tau) d\tau,$$

351 where

$$352 \quad (59) \quad \begin{aligned} & B_S[K^*[\beta]](\mathbf{x}_0, t, \tau) \\ &= \int_{-\infty}^{+\infty} \mathcal{D}_0 \frac{e^{-\frac{s^2+y(s)^2}{4\mathcal{D}_0(t-\tau)}}}{\sqrt{4\pi\mathcal{D}_0(t-\tau)}} (\alpha_1(s)\alpha_2(\tau) + O(\alpha_3(\tau))) \sqrt{1+(y'(s))^2} ds. \end{aligned}$$

353 Note for simplicity, we replaced $\alpha_1(\mathbf{x}_0)$ by $\alpha_1(s)$ to indicate the local parametrization
 354 of Γ around \mathbf{x}_0 , as described previously.

355 To compute the above spatial integral we note the dominant contribution of the
 356 Gaussian $e^{-\frac{s^2}{4\mathcal{D}_0(t-\tau)}}$ and make the change of variables $r = \frac{s}{\sqrt{4\mathcal{D}_0(t-\tau)}}$ to obtain

$$357 \quad \begin{aligned} B_S[K^*[\beta]](\mathbf{x}_0, t, \tau) &= \int_{-\infty}^{+\infty} \frac{\mathcal{D}_0}{\sqrt{\pi}} e^{-r^2} e^{-\frac{y(rv)^2}{v^2}} \\ &\left(\alpha_1(rv)\alpha_2\left(t - \frac{v^2}{4\mathcal{D}_0}\right) + O\left(\alpha_3\left(t - \frac{v^2}{4\mathcal{D}_0}\right)\right) \right) \sqrt{1+(y'(rv))^2} dr, \end{aligned}$$

358 where $v = \sqrt{4\mathcal{D}_0(t-\tau)}$. We would like an asymptotic expansion of the above integral
 359 in v . We note $y(rv) = \frac{1}{2}k(\mathbf{x}_0)r^2v^2 + O(r^3v^3)$ and $\alpha_1(0) = \frac{(\mathcal{D}_0)^{3/2}k(\mathbf{x}^0)}{3\sqrt{\pi}} (\mathbf{u}_{\mathbf{g}} \cdot \nu(\mathbf{x}^0))$.
 360 The order $O(v)$ term only occurs in α_1 and we do not need to take it into account
 361 due to the anti-symmetry of $e^{-r^2}r$. So we compute the space integral to obtain

$$362 \quad \begin{aligned} &= \int_{-\infty}^{+\infty} \frac{\mathcal{D}_0}{\sqrt{\pi}} e^{-r^2} \left((\alpha_1(0) + O(r^2v^2)) \alpha_2\left(t - \frac{v^2}{4\mathcal{D}_0}\right) + O\left(\alpha_3\left(t - \frac{v^2}{4\mathcal{D}_0}\right)\right) \right) dr \\ &= \alpha_2\left(t - \frac{v^2}{4\mathcal{D}_0}\right) (\mathcal{D}_0\alpha_1(0) + O(v^2)) + O\left(\alpha_3\left(t - \frac{v^2}{4\mathcal{D}_0}\right)\right). \end{aligned}$$

363 We now take the above expression and put it into the time integral to get
 364 $S[K^*[\beta]](\mathbf{x}_0, t)$:

$$365 \quad \int_0^t \frac{1}{\sqrt{4\pi\mathcal{D}_0(t-\tau)}} (\alpha_2(\tau) (\mathcal{D}_0\alpha_1(0) + O(t-\tau)) + O(\alpha_3(\tau))) d\tau.$$

366 Using the following property of the beta function (the Euler integral of the first kind)

$$367 \quad \int_0^t (t-\tau)^w \tau^p d\tau = t^{p+w+1} \frac{\Gamma(p+1)\Gamma(w+1)}{\Gamma(w+p+2)},$$

368 we can compute $\int_0^t \frac{1}{\sqrt{(t-\tau)}} \alpha_2(\tau) d\tau$ exactly:

$$\begin{aligned}
 & \int_0^t \frac{\tau^{\frac{3}{2}}}{\sqrt{t-\tau}} d\tau = \frac{3\pi}{8} t^2, \\
 369 \quad (60) \quad & \int_0^\delta \frac{\tau^{\frac{3}{2}}}{\sqrt{t-\tau}} d\tau + \int_\delta^t \frac{\tau^{\frac{3}{2}} - (\tau-\delta)^{\frac{3}{2}}}{\sqrt{t-\tau}} d\tau = \frac{3\pi}{8} (t^2 - (t-\delta)^2) \\
 & \int_0^\delta \frac{\tau^{\frac{3}{2}}}{\sqrt{t-\tau}} d\tau + \int_\delta^\Delta \frac{\tau^{\frac{3}{2}} - (\tau-\delta)^{\frac{3}{2}}}{\sqrt{t-\tau}} d\tau + \int_\Delta^t \frac{\tau^{\frac{3}{2}} - (\tau-\delta)^{\frac{3}{2}} - (\tau-\Delta)^{\frac{3}{2}}}{\sqrt{t-\tau}} d\tau \\
 & = \frac{3\pi}{8} (t^2 - (t-\delta)^2 - (t-\Delta)^2).
 \end{aligned}$$

370 Therefore, the dominant asymptotic terms are:

$$\begin{aligned}
 (61) \quad & S \left[-\frac{4}{\mathcal{D}_0} K^*[\beta] \right] (\mathbf{x}^0, t) = -\frac{4}{\mathcal{D}_0} \frac{\mathcal{D}_0^2}{16} k(\mathbf{x}^0) (\mathbf{u}_{\mathbf{g}} \cdot \nu(\mathbf{x}^0)) \begin{cases} t^2 \\ t^2 - (t-\delta)^2 \\ t^2 - (t-\delta)^2 - (t-\Delta)^2. \end{cases} \\
 371 \quad & + O \begin{cases} (t^3) & \text{if } 0 < t \leq \delta, \\ (t^3 - (t-\delta)^3), & \text{if } \delta < t \leq \Delta, \\ (t^3 - (t-\delta)^3 - (t-\Delta)^3) & \text{if } \Delta < t \leq \Delta + \delta, \end{cases}
 \end{aligned}$$

372 where we computed the error term by evaluating $\int_0^t \frac{1}{\sqrt{(t-\tau)}} \alpha_2(\tau) (t-\tau) d\tau$ and

373 $\int_0^t \frac{1}{\sqrt{(t-\tau)}} \alpha_3(\tau) d\tau$, again using property of the beta function. Namely, for

374 $\int_0^t \frac{1}{\sqrt{(t-\tau)}} \alpha_2(\tau) (t-\tau) d\tau$, we have

$$\begin{aligned}
 & \int_0^t \frac{\tau^{\frac{3}{2}}}{\sqrt{t-\tau}} (t-\tau) d\tau = \frac{\pi}{16} t^3, \\
 & \int_0^\delta \frac{\tau^{\frac{3}{2}}}{\sqrt{t-\tau}} (t-\tau) d\tau + \int_\delta^t \frac{\tau^{\frac{3}{2}} - (\tau-\delta)^{\frac{3}{2}}}{\sqrt{t-\tau}} (t-\tau) d\tau = \frac{\pi}{16} (t^3 - (t-\delta)^3) \\
 375 \quad (62) \quad & \int_0^\delta \frac{\tau^{\frac{3}{2}}}{\sqrt{t-\tau}} (t-\tau) d\tau + \int_\delta^\Delta \frac{\tau^{\frac{3}{2}} - (\tau-\delta)^{\frac{3}{2}}}{\sqrt{t-\tau}} (t-\tau) d\tau \\
 & + \int_\Delta^t \frac{\tau^{\frac{3}{2}} - (\tau-\delta)^{\frac{3}{2}} - (\tau-\Delta)^{\frac{3}{2}}}{\sqrt{t-\tau}} (t-\tau) d\tau \\
 & = \frac{\pi}{16} (t^3 - (t-\delta)^3 - (t-\Delta)^3).
 \end{aligned}$$

376 For $\int_0^t \frac{1}{\sqrt{t-\tau}} \alpha_3(\tau) d\tau$, we have

$$\begin{aligned}
& \int_0^t \frac{\tau^{\frac{5}{2}}}{\sqrt{t-\tau}} d\tau = \frac{5\pi}{16} t^3, \\
& \int_0^\delta \frac{\tau^{\frac{5}{2}}}{\sqrt{t-\tau}} d\tau + \int_\delta^t \frac{\tau^{\frac{5}{2}} - (\tau-\delta)^{\frac{3}{2}}}{\sqrt{t-\tau}} d\tau = \frac{5\pi}{16} (t^3 - (t-\delta)^3) \\
& \int_0^\delta \frac{\tau^{\frac{5}{2}}}{\sqrt{t-\tau}} d\tau + \int_\delta^\Delta \frac{\tau^{\frac{5}{2}} - (\tau-\delta)^{\frac{5}{2}}}{\sqrt{t-\tau}} d\tau + \int_\Delta^t \frac{\tau^{\frac{5}{2}} - (\tau-\delta)^{\frac{5}{2}} - (\tau-\Delta)^{\frac{5}{2}}}{\sqrt{t-\tau}} d\tau \\
& = \frac{5\pi}{16} (t^3 - (t-\delta)^3 - (t-\Delta)^3).
\end{aligned}
\tag{63}$$

378 Replacing the various expressions in (50) with the calculations we did above, we
379 obtain the approximation with the error bound:

$$\begin{aligned}
S[\mu](\mathbf{x}^0, t) &= \frac{4(\mathcal{D}_0)^{1/2}}{3\sqrt{\pi}} \mathbf{u}_g \cdot \nu(\mathbf{x}^0) \begin{cases} t^{3/2} \\ t^{3/2} - (t-\delta)^{3/2} \\ t^{3/2} - (t-\delta)^{3/2} - (t-\Delta)^{3/2} \end{cases} \\
& - \frac{\mathcal{D}_0}{16} k(\mathbf{x}^0) (\mathbf{u}_g \cdot \nu(\mathbf{x}^0)) \begin{cases} t^2 \\ t^2 - (t-\delta)^2 \\ t^2 - (t-\delta)^2 - (t-\Delta)^2 \end{cases} + \text{higher order terms.}
\end{aligned}
\tag{64}$$

381 Now using (64) we compute the approximate expressions of $h(t)$ in each time-interval
382 with the corresponding errors in time.

383 In the first interval, we obtain

$$384 \quad (65) \quad h(t) = \frac{1}{|\Omega|} \int_\Gamma \omega(\mathbf{x}, t) (\mathbf{u}_g \cdot \nu(\mathbf{x})) ds_{\mathbf{x}} = P t^{3/2} + O(P_{\text{err}} t^2),$$

385 where

$$386 \quad (66) \quad P = \frac{1}{|\Omega|} \int_\Gamma \left(\frac{4}{3\sqrt{\pi}} \sqrt{\mathcal{D}_0} (\mathbf{u}_g \cdot \nu(\mathbf{x})) \right)^2 ds_{\mathbf{x}}$$

$$387 \quad (67) \quad P_{\text{err}} = -\frac{\mathcal{D}_0}{4|\Omega|} \int_\Gamma k(\mathbf{x}) (\mathbf{u}_g \cdot \nu(\mathbf{x}))^2 ds_{\mathbf{x}}$$

388
389 and

$$390 \quad (68) \quad I = \frac{\mathcal{D}_0}{\delta^2 \left(\Delta - \frac{\delta}{3}\right)} \int_0^\delta t h(t) dt = \frac{2\mathcal{D}_0 P}{7 \left(\Delta - \frac{\delta}{3}\right)} \delta^{7/2} + O\left(\mathcal{D}_0 P_{\text{err}} \frac{\delta^2}{4 \left(\Delta - \frac{\delta}{3}\right)}\right).$$

391 Between the pulses, we obtain

$$392 \quad (69) \quad h(t) = \frac{1}{|\Omega|} \int_\Gamma \omega(\mathbf{x}, t) (\mathbf{u}_g \cdot \nu(\mathbf{x})) ds_{\mathbf{x}} = P \left(t^{3/2} - (t-\delta)^{3/2} \right) + O\left(P_{\text{err}} (t^2 - (t-\delta)^2)\right)$$

393 and

$$\begin{aligned}
394 \quad (70) \quad II &= \frac{\mathcal{D}_0}{\delta^2 \left(\Delta - \frac{\delta}{3}\right)} \int_\delta^\Delta \delta h(t) dt = -\frac{2}{5} \frac{\mathcal{D}_0 P \left(\delta^{7/2} - \Delta^{5/2} \delta + (\Delta - \delta)^{5/2} \delta \right)}{\delta^2 \left(\Delta - \frac{\delta}{3}\right)} \\
& + O\left(\mathcal{D}_0 P_{\text{err}} \left(\frac{\Delta^2 - \delta \Delta}{\Delta - \frac{\delta}{3}} \right)\right).
\end{aligned}$$

396

397 During the second pulse, we find

$$398 \quad h(t) = \frac{1}{|\Omega|} \int_{\Gamma} \omega(\mathbf{x}, t) (\mathbf{u}_{\mathbf{g}} \cdot \nu(\mathbf{x})) ds_{\mathbf{x}} = P \left(t^{3/2} - (t - \delta)^{3/2} - (t - \Delta)^{3/2} \right) \\ 399 \quad + O \left(P_{\text{err}} \left(t^2 - (t - \delta)^2 - (t - \Delta)^2 \right) \right) \\ 400 \quad (71)$$

401 and

$$402 \quad III = \frac{\mathcal{D}_0}{\delta^2 \left(\Delta - \frac{\delta}{3} \right)} \int_{\Delta}^{\Delta + \delta} (\Delta + \delta - t) h(t) dt \\ 403 \quad = \frac{2}{35} \frac{\mathcal{D}_0 P}{\delta^2 \left(\Delta - \frac{\delta}{3} \right)} \left((2\Delta^3 + \Delta^2 \delta - 8\Delta \delta^2 + 5\delta^3) \sqrt{\Delta - \delta} + 2(\Delta + \delta)^{7/2} \right. \\ 404 \quad \left. - 4\Delta^{7/2} - 7\Delta^{5/2} \delta - 2\delta^{7/2} \right) + O \left(\mathcal{D}_0 P_{\text{err}} \left(\frac{\Delta \delta - \frac{1}{4} \delta^2}{\Delta - \frac{\delta}{3}} \right) \right). \\ 405 \quad (72)$$

406 Finally, adding up the above expressions, we obtain that using the layer potentials
407 representation,

$$408 \quad D_{\mathbf{u}_{\mathbf{g}}}^{\text{eff}} = \mathcal{D}_0 \left[1 - \frac{4}{35} \frac{P}{\delta^2 \left(\Delta - \frac{\delta}{3} \right)} \left((\Delta + \delta)^{7/2} - 2 \left(\delta^{7/2} + \Delta^{7/2} \right) + (\Delta - \delta)^{7/2} \right) \right] \\ 409 \quad + O \left(\mathcal{D}_0 P_{\text{err}} \frac{\Delta^2}{\Delta - \frac{\delta}{3}} \right), \\ 410 \quad (74)$$

411 with P and P_{err} defined in (66) and (67), respectively.

412 We observe that, in the narrow pulse limit, $\delta \ll \Delta$, the expression (73)

$$413 \quad D_{\mathbf{u}_{\mathbf{g}}}^{\text{eff}} = \mathcal{D}_0 \left(1 - \frac{4}{3\sqrt{\pi}} \sqrt{\mathcal{D}_0 \Delta} \frac{\int_{\Gamma} (\mathbf{u}_{\mathbf{g}} \cdot \nu)^2 ds_{\mathbf{x}}}{|\Omega|} \right) + O(\mathcal{D}_0 P_{\text{err}} \Delta), \\ 414$$

415 reduces to the formula given in [1, 9]. If Ω is an isotropic domain, then

$$416 \quad (75) \quad \frac{\int_{\Gamma} (\mathbf{u}_{\mathbf{g}} \cdot \nu)^2 ds_{\mathbf{x}}}{|\Omega|} = \frac{|\Gamma|}{d|\Omega|},$$

417 which is the ratio of surface to volume divided by the space dimension d , exactly
418 the quantity contained in the formula in [27]. Hence our new formula in (73) is a
419 correction of the results in [1, 9, 27] because it takes into account the contribution of
420 δ . This makes the new formula applicable for cases where the narrow pulse assumption
421 $\delta \ll \Delta$ does not hold. Of course, this description still hold only for short times due
422 to the nature of the asymptotic expansions for layer potentials.

423 **3.3. Mixed approximation.** When the pulses are short but the delay between
424 the pulses is not short (with respect to diffusion in Ω), we use the single layer potential
425 representation in the first and third intervals and the eigenfunction representation
426 between the pulses.

427 In the first pulse, $t \in [0, \delta]$, we have the same results as in the previous section,
428 namely,

$$429 \quad (76) \quad I = \frac{8}{21A|\Omega|\sqrt{\pi}} \mathcal{D}_0^{3/2} \delta^{7/2} \int_{\Gamma} (\mathbf{u}_{\mathbf{g}} \cdot \nu)^2 ds_{\mathbf{x}} + O \left(\frac{\delta^2}{\left(\Delta - \frac{\delta}{3} \right)} \right).$$

430 Between the pulses, $t \in [\delta, \Delta]$, the Neumann boundary condition in (18) is

431 (77)
$$\mathcal{D}_0 \nabla \omega(\mathbf{x}, t) \cdot \nu = \mathcal{D}_0 \delta \mathbf{u}_{\mathbf{g}} \cdot \nu, \quad \text{on } \Gamma \times [\delta, \Delta]$$

432 and the initial condition is

433 (78)
$$\omega(\mathbf{x}, \delta) = S[2\delta \mathbf{u}_{\mathbf{g}} \cdot \nu](\mathbf{x}, \delta) + O(\delta^2), \quad \mathbf{x} \text{ in } \Omega.$$

434 The function $\tilde{\omega}(\mathbf{x}, t) = \omega(\mathbf{x}, t) - \delta \mathbf{x} \cdot \mathbf{u}_{\mathbf{g}}$ satisfies homogeneous Neumann boundary
435 condition and the initial condition

436 (79)
$$\tilde{\omega}(\mathbf{x}, \delta) = S[(2\delta \mathbf{u}_{\mathbf{g}} \cdot \nu)](\mathbf{x}, \delta) - \delta \mathbf{x} \cdot \mathbf{u}_{\mathbf{g}}.$$

437 This means

438 (80)
$$\tilde{\omega}(\mathbf{x}, t) = c_0 + \sum_{n=1}^{\infty} c_n e^{-\lambda_n \mathcal{D}_0(t-\delta)} \phi_n(\mathbf{x})$$

439 where

440 (81)
$$c_0 = -\delta a_0 + b_0 = -\frac{\delta}{|\Omega|} \int_{\Omega} \mathbf{x} \cdot \mathbf{u}_{\mathbf{g}} d\mathbf{x} + \frac{1}{|\Omega|} \int_{\Omega} \omega(\mathbf{x}, \delta) d\mathbf{x},$$

441 (82)
$$c_n = -\delta a_n + b_n = -\delta \int_{\Omega} \mathbf{x} \cdot \mathbf{u}_{\mathbf{g}} \phi_n(\mathbf{x}) d\mathbf{x} + \int_{\Omega} \omega(\mathbf{x}, \delta) \phi_n(\mathbf{x}) d\mathbf{x}$$

442

443 with again ϕ_n and λ_n the Neumann eigenfunctions and eigenvalues associated to the
444 Laplace operator ($n = 1, 2, \dots$). Thus, for $t \in [\delta, \Delta]$,

445 (83)
$$\omega(\mathbf{x}, t) = c_0 + \sum_{n=1}^{\infty} c_n e^{-\lambda_n \mathcal{D}_0(t-\delta)} \phi_n(\mathbf{x}) + \delta \mathbf{x} \cdot \mathbf{u}_{\mathbf{g}} + O(\delta^2),$$

446 and

447 (84)
$$h(t) = \sum_{n=1}^{\infty} \frac{c_n \lambda_n a_n}{|\Omega|} e^{-\lambda_n \mathcal{D}_0(t-\delta)} + \delta + O\left(\frac{\delta^2}{A}\right),$$

448 and

449 (85)
$$II = \frac{1}{A} \sum_{n=1}^{\infty} \frac{c_n a_n}{|\Omega|} \left(1 - e^{-\lambda_n \mathcal{D}_0(\Delta-\delta)}\right) + \frac{\mathcal{D}_0 \delta^2 (\Delta - \delta)}{A} + O\left(\frac{\delta(\Delta - \delta)}{(\Delta - \frac{\delta}{3})}\right).$$

450 During the second pulse, $t \in [\Delta, \Delta + \delta]$, we keep the solution from the previous
451 interval in Eq. (83) which satisfies homogeneous boundary conditions and just add a
452 single layer potential to match the Neumann boundary condition. We obtain
453

454 (86)
$$\omega(\mathbf{x}, t) = c_0 + \sum_{n=1}^{\infty} c_n e^{-\lambda_n \mathcal{D}_0(t-\delta)} \phi_n(\mathbf{x}) + \delta \mathbf{x} \cdot \mathbf{u}_{\mathbf{g}}$$

455
$$+ S[(-2\tau \mathbf{u}_{\mathbf{g}} \cdot \nu)](\mathbf{x}, t - \Delta) + O((t - \Delta)^2),$$

457 where $t \in [\Delta, \Delta + \delta]$. The density in the single layer potential is $-2\tau \mathbf{u}_{\mathbf{g}} \cdot \nu$ with
458 $\tau \in [0, \delta]$ from a shift in time $\tau = t - \Delta$. Similar reasoning as in the previous sections
459 gives

460
$$S[(-2\tau \mathbf{u}_{\mathbf{g}} \cdot \nu)](\mathbf{x}, t - \Delta) = -\frac{4}{3\sqrt{\pi}|\Omega|} \sqrt{\mathcal{D}_0} (t - \Delta)^{3/2} \int_{\Gamma} (\mathbf{u}_{\mathbf{g}} \cdot \nu) + O((t - \Delta)^{5/2}),$$

490 where $\omega_{\mathbf{u}_g}(\mathbf{x}, t)$ solves the problem (17). Because of the linearity of the Neumann
491 problem, for every direction $\mathbf{u}_g = [u_1, \dots, u_d]$ we have that

$$492 \quad (94) \quad \omega_{\mathbf{u}_g}(\mathbf{x}, t) = \sum_{i=1}^d u_i \omega_{\mathbf{e}_i}(\mathbf{x}, t),$$

493 where \mathbf{e}_i is the i -th vector of the canonical basis of \mathbb{R}^d . As a consequence

$$494 \quad D_{\mathbf{u}_g}^{\text{eff}} = \mathcal{D}_0 - \frac{\mathcal{D}_0}{A|\Omega|} \int_0^{TE} F \int_{\Omega} (u_1 \mathbf{e}_1 + \dots + u_d \mathbf{e}_d) \cdot (u_1 \nabla \omega_{\mathbf{e}_1} + \dots + u_d \nabla \omega_{\mathbf{e}_d}) d\mathbf{x} dt$$

$$495 \quad = \mathcal{D}_0 - \frac{\mathcal{D}_0}{A|\Omega|} \int_0^{TE} F \left(\sum_{i=1}^d u_i^2 \int_{\Omega} \mathbf{e}_i \cdot \nabla \omega_{\mathbf{e}_i} d\mathbf{x} + \sum_{\substack{i \neq j \\ i, j=1}}^d u_i u_j \int_{\Omega} \mathbf{e}_i \cdot \nabla \omega_{\mathbf{e}_j} d\mathbf{x} \right) dt$$

497 and thus, if we want to average over all the possible directions, we are interested in
498 the integrals

$$499 \quad (95) \quad \frac{\int_{\mathbb{S}^{d-1}} u_i^2 d\mathbf{u}}{\int_{\mathbb{S}^{d-1}} d\mathbf{u}}, \quad i = 1, \dots, d \quad \text{and} \quad \frac{\int_{\mathbb{S}^{d-1}} u_i u_j d\mathbf{u}}{\int_{\mathbb{S}^{d-1}} d\mathbf{u}}, \quad i, j = 1, \dots, d, i \neq j.$$

500 We observe that, for all $i, j = 1, \dots, d$ and $i \neq j$,

$$501 \quad (96) \quad \int_{\mathbb{S}^{d-1}} u_i u_j d\mathbf{u} = 0.$$

502 Therefore, what remains in the average are just the terms

$$503 \quad (97) \quad \sum_{i=1}^d \frac{\int_{\mathbb{S}^{d-1}} u_i^2 d\mathbf{u}}{\int_{\mathbb{S}^{d-1}} d\mathbf{u}} \int_{\Omega} \mathbf{e}_i \cdot \nabla \omega_{\mathbf{e}_i} d\mathbf{x},$$

504 i.e. simply the average over d perpendicular directions and then

$$505 \quad (98) \quad D_{\text{ave}}^{\text{eff}} = \mathcal{D}_0 - \sum_{i=1}^d \frac{\mathcal{D}_0}{dA|\Omega|} \int_0^{TE} F(t) \int_{\Omega} \mathbf{u}_g^i \cdot \nabla \omega_{\mathbf{u}_g^i}(\mathbf{x}, t) d\mathbf{x} dt$$

506 where $\mathbf{u}_g^i, i = 1, \dots, d$ are d orthogonal directions. In short, averaging over all the
507 possible directions is equivalent to average only over d orthogonal normalized direc-
508 tions.

509 We use the fact that

$$510 \quad (99) \quad \sum_{i=1}^d \frac{\int_{\Gamma} (\mathbf{u}_g^i \cdot \nu)^2 ds_{\mathbf{x}}}{d} = \frac{|\Gamma|}{d}$$

511 and we define

$$512 \quad (100) \quad k_n := \sum_{i=1}^d \frac{-(a_n^i)^2}{d|\Omega|} = \sum_{i=1}^d \frac{-(\int_{\Omega} \mathbf{x} \cdot \mathbf{u}_g^i \phi_n(\mathbf{x}) d\mathbf{x})^2}{d|\Omega|} d\mathbf{u}_g,$$

513 i.e. the mean over d orthogonal directions of the square of the first moment along
514 these directions, and

$$515 \quad (101) \quad j_n := \sum_{i=1}^d \frac{b_n^i a_n^i}{d|\Omega|} = \sum_{i=1}^d \frac{(\int_{\Omega} \omega_{\mathbf{u}_g^i}(\mathbf{x}, \delta) \phi_n(\mathbf{x}) d\mathbf{x}) (\int_{\Omega} \mathbf{x} \cdot \mathbf{u}_g^i \phi_n(\mathbf{x}) d\mathbf{x})}{d|\Omega|}.$$

516 In summary, the eigenfunction expansion in (36) gives
 517

$$518 \quad (102) \quad D_{ave}^{\text{eff}} = \sum_{n=1}^{\infty} \frac{k_n}{\mathcal{D}_0^2 \lambda_n^2 \delta^2 \left(\Delta - \frac{\delta}{3}\right)} \left[e^{-\mathcal{D}_0 \lambda_n (\Delta + \delta)} + e^{-\mathcal{D}_0 \lambda_n (\Delta - \delta)} \right. \\ 519 \quad \left. - 2 \left(\mathcal{D}_0 \lambda_n \delta + e^{-\mathcal{D}_0 \lambda_n \delta} + e^{-\mathcal{D}_0 \lambda_n \Delta} - 1 \right) \right]$$

521 The single layer potential representation gives

$$522 \quad (103) \quad D_{ave}^{\text{eff}} = \mathcal{D}_0 - \frac{16}{35} \frac{\mathcal{D}_0^{3/2}}{\delta^2 (3\Delta - \delta) \sqrt{\pi}} \left[(\Delta - \delta)^{7/2} + (\Delta + \delta)^{7/2} - 2 \left(\delta^{7/2} + \Delta^{7/2} \right) \right] \frac{|\Gamma|}{d|\Omega|} \\ 523 \quad + O(\Delta).$$

524 The mixed approximation in (89) gives

$$525 \quad (104) \quad D_{ave}^{\text{eff}} = \frac{\mathcal{D}_0 \delta}{6 \left(\Delta - \frac{\delta}{3}\right)} - \frac{8 \mathcal{D}_0^{3/2} \delta^{3/2}}{35 \sqrt{\pi} \left(\Delta - \frac{\delta}{3}\right) d|\Omega|} \\ - \sum_{n=1}^{\infty} \frac{\delta k_n + j_n}{\delta^2 \left(\Delta - \frac{\delta}{3}\right)} \left(\delta - \frac{e^{-\lambda_n \mathcal{D}_0 \Delta} (1 - e^{\lambda_n \mathcal{D}_0 \delta})}{\lambda_n \mathcal{D}_0} \right) \\ 526 \quad + O \left(\max \left\{ \frac{\delta^2}{\left(\Delta - \frac{\delta}{3}\right)}, \frac{\delta (\Delta - \delta)}{\left(\Delta - \frac{\delta}{3}\right)} \right\} \right).$$

527 **5. Numerical results.** In this Section we numerically validate the approximate
 528 formulas we derived in the previous sections. To compute the reference quantities we
 529 solved the diffusion equation in (17) using the Matlab PDEToolbox. The eigenvalues
 530 and eigenfunctions of the Laplace equation with Neumann boundary conditions were
 531 also computed with the same software. The convergence between the H-ADC model
 532 and the Bloch-Torrey equation was shown previously in [14].

533 First we show the three approximations of $h(t)$. We consider a 2D geometry of one
 534 vertically orientated ellipse with semi-axes of $19\mu\text{m}$ and $9\mu\text{m}$. The intrinsic diffusion
 535 coefficient is set to $\mathcal{D}_0 = 1e^{-3}\text{mm}^2/\text{s}$ and we vary the values of δ , Δ and \mathbf{u}_g . To
 536 compute the reference solution $h(t)$ we solved the problem (17) on the finite element
 537 mesh shown in Fig. 2. The eigenvalues and eigenfunctions are also computed on the
 538 same finite element mesh. The projections a_n and b_n are computed according to the
 539 formulas in (25) and (81).

540 For this particular geometry the first four non-zero eigenvalues are

$$541 \quad \lambda_1 = 0.0097, \quad \lambda_2 = 0.0325, \quad \lambda_3 = 0.0383, \quad \lambda_4 = 0.0644,$$

542 and their numerically calculated projections a_i are reported in the table below.

543 Clearly, among the four eigenvalues, in the direction $\mathbf{u}_g = [1, 0]$, all but λ_3 have
 544 negligible contribution, and in the direction $\mathbf{u}_g = [0, 1]$, all but λ_1 have negligible
 545 contribution.

546 In the following plots we always indicate the reference quantity with a line, the
 547 single layer approximation with squares, the eigenfunction approximation with circles
 548 and the mixed approximation with asterisks.

549 In Figure 3 we considered $\delta = 5\text{ms}$, $\Delta = 10\text{ms}$ and $\mathbf{u}_g = [1, 0]$. As we can see
 550 the single layer approximation (squares) fits very well the reference quantity (contin-
 551 uous line) in all three time intervals. We also notice that the mixed approximation

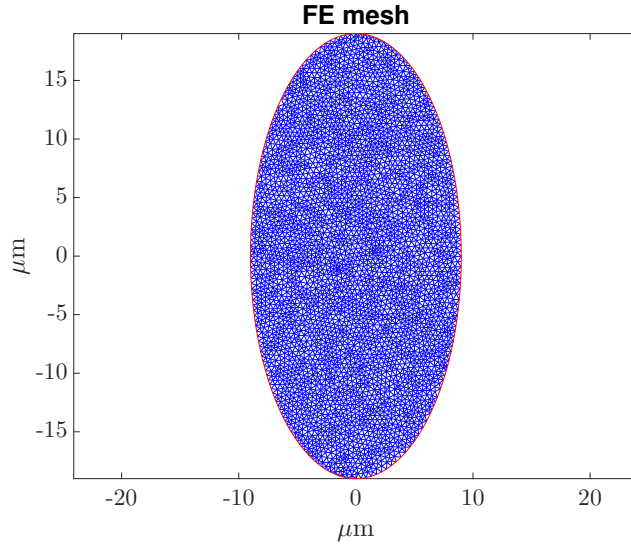

Fig. 2: Finite elements mesh of an ellipse with semiaxes of $19\mu\text{m}$ and $9\mu\text{m}$, orientated vertically along the y -axis.

\mathbf{u}_g	a_1	a_2	a_3	a_4
$[1, 0]$	38.9	-25.7	$-4.62e^{+5}$	-0.97
$[0, 1]$	$1.07e^{+6}$	1.75	-4.49	-5.58

Table 1: The first moments of the eigenfunction associated with the first four non-zero eigenvalues in the two directions $\mathbf{u}_g = [1, 0]$ and $\mathbf{u}_g = [0, 1]$.

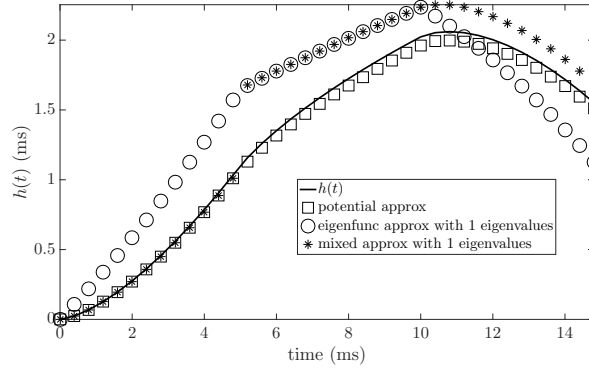

Fig. 3: $h(t)$ and its approximation (using the three different formulas found) with respect to the gradient directions $\mathbf{u}_g = [1, 0]$ for an ellipse of semi-axes $19\mu\text{m}$ and $9\mu\text{m}$. Intrinsic diffusion coefficients $\mathcal{D}_0 = 1 \times 10^{-3}\text{mm}^2/\text{s}$, pulses duration $\delta = 5\text{ms}$ and time-delay between pulses $\Delta = 10\text{ms}$.

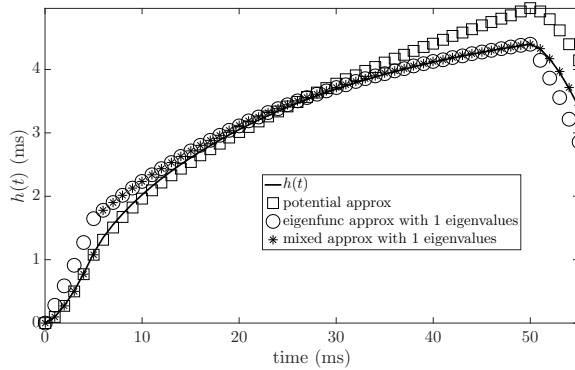

Fig. 4: $h(t)$ and its approximation (using the three different formulas found) with respect to the gradient directions $\mathbf{u}_g = [1, 0]$ for an ellipse of semiaxes $19\mu\text{m}$ and $9\mu\text{m}$. Intrinsic diffusion coefficients $\mathcal{D}_0 = 1 \times 10^{-3}\text{mm}^2/\text{s}$, pulses duration $\delta = 5\text{ms}$ and time-delay between pulses $\Delta = 50\text{ms}$.

552 (asterisks) works sufficiently well during the two pulses but not between them. For
 553 the eigenfunctions approximation, the fit is far from the reference quantity.

554 In Figure 4 we considered $\delta = 5\text{ms}$, $\Delta = 50\text{ms}$ and $\mathbf{u}_g = [1, 0]$. As we can see the
 555 single layer approximation fits well the reference quantity during the first pulse and
 556 until $t \approx 25\text{ms}$, but after that, the approximation is no longer good. The eigenfunction
 557 approximation is not good during the pulses but it becomes accurate at the end of
 558 the interval between them. The mixed approximation fits well during the pulses and
 559 is the same as the eigenfunction approximation between the pulses.

560 In Figures 5a and 5b we show the behaviour of D^{eff} computed for two different
 561 directions of the gradient ($\mathbf{u}_g = [1, 0]$ and $\mathbf{u}_g = [0, 1]$) but the same parameters
 562 ($\delta = 5\text{ms}$ and thirty different values of Δ equally distributed in the interval $[8, 80]\text{ms}$).
 563 In Figure 5c we show the average of $D_{\text{ave}}^{\text{eff}}/\mathcal{D}_0$ along the two perpendicular directions.
 564 Clearly, the single layer formula works well for at short $\Delta + \delta$, the eigenfunctions
 565 formula for long $\Delta + \delta$.

566 To conclude, in Figure 6 we report the absolute error

$$567 \quad |D^{\text{eff}} - D^{\text{approx}}|$$

568 for the same parameters as before in the two orthogonal directions. As we can see,
 569 the single layer approximation is better at short times and the eigenfunctions approx-
 570 imation is better at long times. The time at which the switch between the short and
 571 the long diffusion time approximations occurs at around $t = 50\text{ms}$ in the direction
 572 $[1, 0]$ and it occurs at around $t = 25\text{ms}$ in the direction $[0, 1]$.

573 **6. Conclusions.** Diffusion Magnetic Resonance Imaging (dMRI) can be used to
 574 measure a time and direction dependent effective diffusion coefficient which can in turn
 575 reveal information about the tissue micro-structure. Recently a new mathematical
 576 model for the effective diffusion coefficient, the H-ADC model, was obtained using
 577 homogenization techniques after imposing a certain scaling relationship between the
 578 physical parameters. The resulting model depends on the solution of a diffusion
 579 equation subject to time-dependent Neumann boundary conditions.

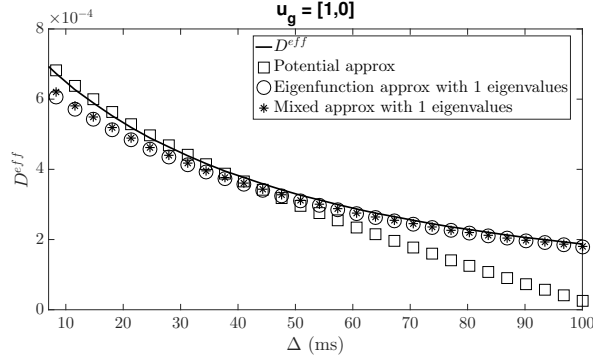
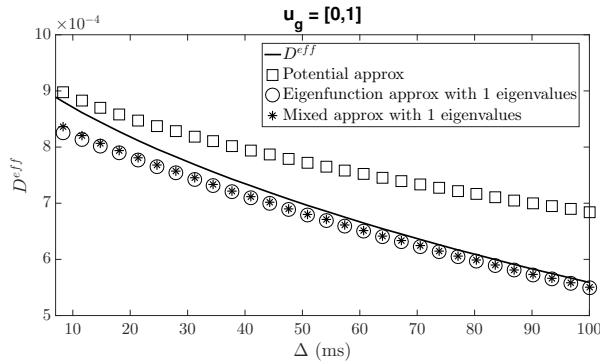
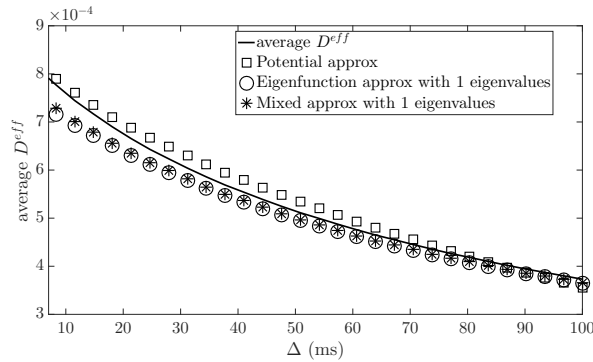
(a) Gradient direction $\mathbf{u}_g = [1, 0]$ (b) Gradient direction $\mathbf{u}_g = [0, 1]$ 

(c) Average over both directions

Fig. 5: D^{eff} with respect to two different gradient directions as well as $D_{\text{ave}}^{\text{eff}}$, the average over both direction, compared to approximations using the three different formulas, for an ellipse of semiaxes $19\mu\text{m}$ and $9\mu\text{m}$. Intrinsic diffusion coefficients $D_0 = 1 \times 10^{-3}\text{mm}^2/\text{s}$, pulses duration $\delta = 5\text{ms}$ and thirty different values of the time-delay between pulses in the interval $[8, 80]\text{ms}$.

580 In this paper, we analysed the H-ADC model in the case of finite sub-domains.
 581 In particular, we obtained three representations of the effective diffusion coefficient



 (a) Gradient direction $\mathbf{u}_g = [1, 0]$

 (b) Gradient direction $\mathbf{u}_g = [0, 1]$

Fig. 6: Absolute error $|D^{\text{eff}} - D^{\text{approx}}|$ using the three different formulas found with respect to two different gradient directions for an ellipse of semi-axes $19\mu\text{m}$ and $9\mu\text{m}$. Intrinsic diffusion coefficients $\mathcal{D}_0 = 1 \times 10^{-3}\text{mm}^2/\text{s}$, pulses duration $\delta = 5\text{ms}$ and thirty different values of the time-delay between pulses in the interval $[8, 80]\text{ms}$.

582 that are appropriate in different diffusion time regimes. In the short time regime, we
 583 proposed using a representation based on the single layer potential. In the long time
 584 regime when the pulse duration is not short, we proposed using a representation based
 585 on the eigenfunctions expansion of the Neumann Laplace operator. In the long time
 586 regime when the pulse duration is short, we proposed a representation that combines
 587 the single layer potential during the pulses with the eigenfunction expansion between
 588 the pulses. In particular, in the short time regime, our representation corrects an
 589 existing formula by correctly accounting for the pulse duration. Our work helps to
 590 make more precise how parameters of the tissue micro-structure such as the surface to
 591 volume ratio or the dominant eigenvalue and its projection affect the effective diffusion
 592 coefficient.

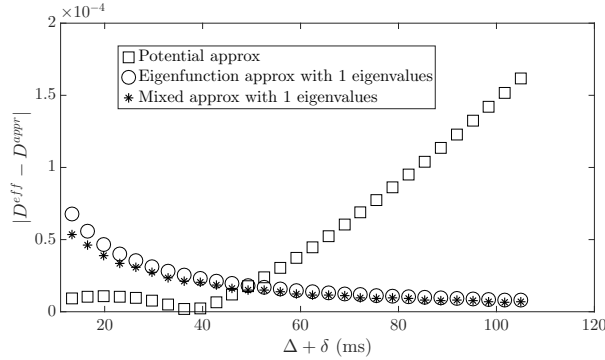
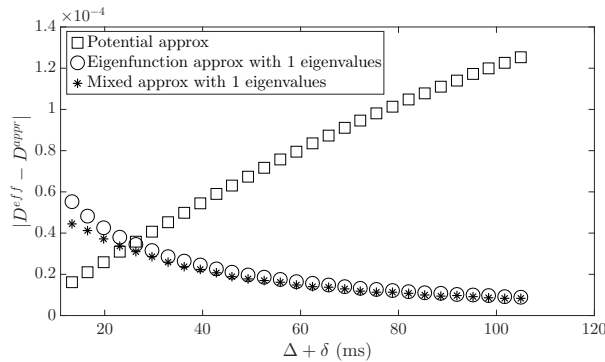
593

REFERENCES

- 594 [1] S. AXELROD AND P. N. SEN, Nuclear magnetic resonance spin echoes for restricted diffusion
 595 in an inhomogeneous field: Methods and asymptotic regimes, The Journal of Chemical
 596 Physics, 114 (2001), p. 6878, <http://link.aip.org/link/?JCPA6/114/6878/1>.

- 597 [2] A. V. BARZYKIN, Theory of spin echo in restricted geometries under a step-wise gradient
598 pulse sequence, Journal of Magnetic Resonance, 139 (1999), pp. 342–353, [http://www.](http://www.sciencedirect.com/science/article/pii/S1090780799917780)
599 [sciencedirect.com/science/article/pii/S1090780799917780](http://www.sciencedirect.com/science/article/pii/S1090780799917780).
- 600 [3] L. M. BURCAW, E. FIEREMANS, AND D. S. NOVIKOV, Mesoscopic structure of neuronal
601 tracts from time-dependent diffusion, NeuroImage, 114 (2015), pp. 18 – 37, [https:](https://doi.org/http://dx.doi.org/10.1016/j.neuroimage.2015.03.061)
602 [//doi.org/http://dx.doi.org/10.1016/j.neuroimage.2015.03.061](https://doi.org/http://dx.doi.org/10.1016/j.neuroimage.2015.03.061), [http://www.sciencedirect.](http://www.sciencedirect.com/science/article/pii/S1053811915002578)
603 [com/science/article/pii/S1053811915002578](http://www.sciencedirect.com/science/article/pii/S1053811915002578).
- 604 [4] P. T. CALLAGHAN, A. COY, D. MACGOWAN, K. J. PACKER, AND F. O. ZELAYA, Diffraction-like
605 effects in nmr diffusion studies of fluids in porous solids, Nature, 351 (1991), pp. 467–469,
606 <http://dx.doi.org/10.1038/351467a0>.
- 607 [5] J. CHEN, W. LIU, H. ZHANG, L. LACY, X. YANG, S.-K. SONG, S. A. WICKLINE, AND
608 X. YU, Regional ventricular wall thickening reflects changes in cardiac fiber and sheet
609 structure during contraction: quantification with diffusion tensor MRI, American Journal
610 of Physiology - Heart and Circulatory Physiology, 289 (2005), pp. H1898–H1907,
611 <https://doi.org/10.1152/ajpheart.00041.2005>.
- 612 [6] J. CHEN, S.-K. SONG, W. LIU, M. MCLEAN, J. S. ALLEN, J. TAN, S. A. WICKLINE, AND X. YU,
613 Remodeling of cardiac fiber structure after infarction in rats quantified with diffusion tensor
614 MRI, American Journal of Physiology - Heart and Circulatory Physiology, 285 (2003),
615 pp. H946–H954, <https://doi.org/10.1152/ajpheart.00889.2002>.
- 616 [7] H. CHENG AND S. TORQUATO, Effective conductivity of periodic arrays of spheres with interfacial
617 resistance, Proceedings: Mathematical, Physical and Engineering Sciences, 453 (1997),
618 pp. 145–161, <http://www.jstor.org/stable/52987>.
- 619 [8] E. FIEREMANS, L. M. BURCAW, H.-H. LEE, G. LEMBERSKIY, J. VERAART, AND D. S. NOVIKOV,
620 In vivo observation and biophysical interpretation of time-dependent diffusion in human
621 white matter, NeuroImage, 129 (2016), pp. 414 – 427, [https://doi.org/http://dx.doi.](https://doi.org/http://dx.doi.org/10.1016/j.neuroimage.2016.01.018)
622 [org/10.1016/j.neuroimage.2016.01.018](https://doi.org/http://dx.doi.org/10.1016/j.neuroimage.2016.01.018), [http://www.sciencedirect.com/science/article/pii/](http://www.sciencedirect.com/science/article/pii/S1053811916000240)
623 [S1053811916000240](http://www.sciencedirect.com/science/article/pii/S1053811916000240).
- 624 [9] D. GREBENKOV, NMR survey of reflected brownian motion, Reviews of Modern Physics, 79
625 (2007), pp. 1077–1137, <http://dx.doi.org/10.1103/RevModPhys.79.1077>.
- 626 [10] D. GREBENKOV, Laplacian eigenfunctions in NMR. I. A numerical tool, Concepts in Magnetic
627 Resonance Part A, 32A (2008), pp. 277–301, <http://dx.doi.org/10.1002/cmr.a.20117>.
- 628 [11] D. S. GREBENKOV, Laplacian eigenfunctions in NMR. II. Theoretical advances, Concepts
629 Magn. Reson., 34A (2009), pp. 264–296, <http://dx.doi.org/10.1002/cmr.a.20145>.
- 630 [12] L. GREENGARD AND J. STRAIN, A fast algorithm for the evaluation of heat potentials, Comm.
631 Pure Appl. Math., 43 (1990), pp. 949–963.
- 632 [13] R. B. GUENTHER AND J. W. LEE, Partial differential equations of mathematical physics and
633 integral equations, Prentice Hall, Inglewood Cliffs, New Jersey, 1988.
- 634 [14] H. HADDAR, J.-R. LI, AND S. SCHIAVI, A Macroscopic Model for the Diffusion MRI Signal Accounting for Time-Dependent Diffusivity,
635 SIAM Journal on Applied Mathematics, 76 (2016), pp. 930–949, [https:](https://doi.org/10.1137/15M1019398)
636 [//doi.org/10.1137/15M1019398](https://doi.org/10.1137/15M1019398), <http://dx.doi.org/10.1137/15M1019398>, [https:](https://arxiv.org/abs/http://dx.doi.org/10.1137/15M1019398)
637 [//arxiv.org/abs/http://dx.doi.org/10.1137/15M1019398](https://arxiv.org/abs/http://dx.doi.org/10.1137/15M1019398).
- 638 [15] D. HASSELMAN AND L. F. JOHNSON, Effective thermal conductivity of composites with
639 interfacial thermal barrier resistance, Journal of Composite Materials, 21 (1987), pp. 508–
640 515.
- 641 [16] V. KENKRE, Simple solutions of the Torrey-Bloch equations in the NMR study of molecular
642 diffusion, Journal of Magnetic Resonance, 128 (1997), pp. 62–69, [http://dx.doi.org/10.](http://dx.doi.org/10.1006/jmre.1997.1216)
643 [1006/jmre.1997.1216](http://dx.doi.org/10.1006/jmre.1997.1216).
- 644 [17] V. G. KISELEV, The cumulant expansion: an overarching mathematical framework for
645 understanding diffusion nmr, Diffusion MRI: Theory, Methods, and Applications:
646 Theory, Methods, and Applications, (2010), p. 152, [http://books.google.com/books?hl=](http://books.google.com/books?hl=en&lr=&id=dbZCMePD52AC&oi=fnd&pg=PA152&dq=The+cumulant+expansion:+an+overarching+mathematical+framework+for+understanding+diffusion+NMR&ots=YI6BKXffDr&sig=WoLmTLw7ZGATkUe-g3EGbtz79I)
647 [en&lr=&id=dbZCMePD52AC&oi=fnd&pg=PA152&dq=The+c](http://books.google.com/books?hl=en&lr=&id=dbZCMePD52AC&oi=fnd&pg=PA152&dq=The+cumulant+expansion:+an+overarching+mathematical+framework+for+understanding+diffusion+NMR&ots=YI6BKXffDr&sig=WoLmTLw7ZGATkUe-g3EGbtz79I)
648 [umulant+expansion:+an+overarching+mathematical+framework+for+understanding+](http://books.google.com/books?hl=en&lr=&id=dbZCMePD52AC&oi=fnd&pg=PA152&dq=The+cumulant+expansion:+an+overarching+mathematical+framework+for+understanding+diffusion+NMR&ots=YI6BKXffDr&sig=WoLmTLw7ZGATkUe-g3EGbtz79I)
649 [diffusion+NMR&ots=YI6BKXffDr&sig=WoLmTLw7ZGATkUe-g3EGbtz79I](http://books.google.com/books?hl=en&lr=&id=dbZCMePD52AC&oi=fnd&pg=PA152&dq=The+cumulant+expansion:+an+overarching+mathematical+framework+for+understanding+diffusion+NMR&ots=YI6BKXffDr&sig=WoLmTLw7ZGATkUe-g3EGbtz79I).
- 650 [18] L. L. LATOUR, P. P. MITRA, R. L. KLEINBERG, AND C. H. SOTAK, Time-dependent diffusion
651 coefficient of fluids in porous media as a probe of surface-to-volume ratio, Journal of Mag-
652 netic Resonance, Series A, 101 (1993), pp. 342–346.
- 653 [19] L. L. LATOUR, K. SVOBODA, P. P. MITRA, AND C. H. SOTAK, Time-dependent diffusion of
654 water in a biological model system, Proceedings of the National Academy of Sciences, 91
655 (1994), pp. 1229–1233, <http://www.pnas.org/content/91/4/1229.abstract>.
- 656 [20] M. LAZAR, Mapping brain anatomical connectivity using white matter tractography, NMR
657 Biomed., 23 (2010), pp. 821–835, <http://dx.doi.org/10.1002/nbm.1579>.
- 658 [21] D. LE BIHAN AND H. JOHANSEN-BERG, Diffusion MRI at 25: Exploring brain tissue structure

- 659 and function, *NeuroImage*, 61 (2012), pp. 324–341, <http://www.sciencedirect.com/science/article/pii/S1053811911012857>.
- 660
- 661 [22] D. LEBIHAN, S.-I. URAYAMA, T. ASO, T. HANAKAWA, AND H. FUKUYAMA, Direct and fast
662 detection of neuronal activation in the human brain with diffusion mri, *PNAS*, 103 (2006),
663 pp. 8263–8268, <http://www.pnas.org/content/103/21/8263.abstract>.
- 664 [23] J.-R. LI, D. CALHOUN, C. POUPON, AND D. L. BIHAN, Numerical simulation of diffusion MRI signals using an adaptive time-stepping method,
665 Physics in Medicine and Biology, 59 (2014), p. 441, [http://stacks.iop.org/0031-9155/59/](http://stacks.iop.org/0031-9155/59/i=2/a=441)
666 [i=2/a=441](http://stacks.iop.org/0031-9155/59/i=2/a=441).
- 667
- 668 [24] J.-R. LI AND L. GREENGARD, High order accurate methods for the evaluation of layer heat
669 potentials, *SIAM J. Sci. Comput.*, 31 (2009), pp. 3847–3860, [https://doi.org/10.1137/](https://doi.org/10.1137/080732389)
670 [080732389](https://doi.org/10.1137/080732389), <http://dx.doi.org/10.1137/080732389>.
- 671 [25] S. E. MAIER, Y. SUN, AND R. V. MULKERN, Diffusion imaging of brain tumors, *NMR Biomed.*,
672 23 (2010), pp. 849–864, <http://dx.doi.org/10.1002/nbm.1544>.
- 673 [26] P. P. MITRA, P. N. SEN, AND L. M. SCHWARTZ, Short-time behavior of the diffusion coefficient
674 as a geometrical probe of porous media, *Phys. Rev. B*, 47 (1993), pp. 8565–8574, [https://](https://doi.org/10.1103/PhysRevB.47.8565)
675 doi.org/10.1103/PhysRevB.47.8565, <http://link.aps.org/doi/10.1103/PhysRevB.47.8565>.
- 676 [27] P. P. MITRA, P. N. SEN, L. M. SCHWARTZ, AND P. LE DOUSSAL, Diffusion propagator as a
677 probe of the structure of porous media, *Physical review letters*, 68 (1992), pp. 3555–3558.
- 678 [28] M. E. MOSELEY, J. KUCHARCZYK, J. MINTOROVITCH, Y. COHEN, J. KURHANOWICZ, N. DERU-
679 GIN, H. ASGARI, AND D. NORMAN, Diffusion-weighted MR imaging of acute stroke:
680 correlation with T2- weighted and magnetic susceptibility-enhanced MR imaging in cats,
681 *AJNR Am J Neuroradiol*, 11 (1990), pp. 423–429, [http://www.ajnr.org/cgi/content/](http://www.ajnr.org/cgi/content/abstract/11/3/423)
682 [abstract/11/3/423](http://www.ajnr.org/cgi/content/abstract/11/3/423).
- 683 [29] C. H. NEUMAN, Spin echo of spins diffusing in a bounded medium, *The Journal of Chemical*
684 *Physics*, 60 (1974), p. 4508, <http://link.aip.org/link/?JCP/60/4508/1>.
- 685 [30] D. S. NOVIKOV, E. FIEREMANS, J. H. JENSEN, AND J. A. HELPERN, Random walks with barriers,
686 *Nat Phys*, 7 (2011), pp. 508–514, <http://dx.doi.org/10.1038/nphys1936>.
- 687 [31] D. S. NOVIKOV, J. H. JENSEN, J. A. HELPERN, AND E. FIEREMANS, Revealing
688 mesoscopic structural universality with diffusion, *Proceedings of the National Academy*
689 *of Sciences*, (2014), <https://doi.org/10.1073/pnas.1316944111>, [http://www.pnas.org/](http://www.pnas.org/content/early/2014/03/21/1316944111.abstract)
690 [content/early/2014/03/21/1316944111.abstract](http://www.pnas.org/content/early/2014/03/21/1316944111.abstract), [https://arxiv.org/abs/http://www.pnas.](https://arxiv.org/abs/http://www.pnas.org/content/early/2014/03/21/1316944111.full.pdf+html)
691 [org/content/early/2014/03/21/1316944111.full.pdf+html](https://arxiv.org/abs/http://www.pnas.org/content/early/2014/03/21/1316944111.full.pdf+html).
- 692 [32] D. S. NOVIKOV AND V. G. KISELEV, Effective medium theory of a diffusion-weighted signal,
693 *NMR in Biomedicine*, 23 (2010), pp. 682–697, <https://doi.org/10.1002/nbm.1584>, [http://](http://dx.doi.org/10.1002/nbm.1584)
694 dx.doi.org/10.1002/nbm.1584.
- 695 [33] N. PYATIGORSKAYA, D. LE BIHAN, O. REYNAUD, AND L. CIOBANU, Relationship between the diffusion time and the diffusion MRI signal observed at 17.2 tesla in the healthy rat brain cortex.
696 *Magnetic Resonance in Medicine*, (2013), pp. n/a—n/a, [https://doi.org/10.1002/mrm.](https://doi.org/10.1002/mrm.24921)
697 [24921](https://doi.org/10.1002/mrm.24921), <http://dx.doi.org/10.1002/mrm.24921>.
- 698
- 699 [34] B. ROBERTSON, Spin-echo decay of spins diffusing in a bounded region, *Physical Review*, 151
700 (1966), p. 273, http://prola.aps.org/abstract/PR/v151/i1/p273_1.
- 701 [35] D. ROHMER, A. SITEK, AND G. T. GULLBERG, Reconstruction and visualization of fiber and
702 sheet structure with regularized tensor diffusion MRI in the human heart, *Lawrence Berke-*
703 *ley National Laboratory Publication. LBNL-60277*, (2006).
- 704 [36] E. O. STEJSKAL AND J. E. TANNER, Spin diffusion measurements: Spin echoes in the presence of
705 a time-dependent field gradient, *The Journal of Chemical Physics*, 42 (1965), pp. 288–292,
706 <http://dx.doi.org/10.1063/1.1695690>.
- 707 [37] T. SUGAHARA, Y. KOROGI, M. KOCHI, I. IKUSHIMA, Y. SHIGEMATU, T. HIRAI, T. OKUDA,
708 L. LIANG, Y. GE, Y. KOMOHARA, Y. USHIO, AND M. TAKAHASHI, Usefulness of
709 diffusion-weighted MRI with echo-planar technique in the evaluation of cellularity in
710 gliomas, *J. Magn. Reson. Imaging*, 9 (1999), pp. 53–60, [http://dx.doi.org/10.1002/\(SICI\)](http://dx.doi.org/10.1002/(SICI)1522-2586(199901)9:1<53::AID-JMRI7>3.0.CO;2-2)
711 [1522-2586\(199901\)9:1<53::AID-JMRI7>3.0.CO;2-2](http://dx.doi.org/10.1002/(SICI)1522-2586(199901)9:1<53::AID-JMRI7>3.0.CO;2-2).
- 712 [38] A. SZAFER, J. ZHONG, AND J. C. GORE, Theoretical model for water diffusion in tissues, *Magn.*
713 *Reson. Med.*, 33 (1995), pp. 697–712, <http://dx.doi.org/10.1002/mrm.1910330516>.
- 714 [39] S. TORQUATO AND M. D. RINTOUL, Effect of the interface on the properties of composite media,
715 *Phys. Rev. Lett.*, 75 (1995), pp. 4067–, [http://link.aps.org/doi/10.1103/PhysRevLett.75.](http://link.aps.org/doi/10.1103/PhysRevLett.75.4067)
716 [4067](http://link.aps.org/doi/10.1103/PhysRevLett.75.4067).
- 717 [40] Y. TSUSHIMA, A. TAKAHASHI-TAKETOMI, AND K. ENDO, Magnetic resonance (MR) differential
718 diagnosis of breast tumors using apparent diffusion coefficient (ADC) on 1.5-t, *J. Magn.*
719 *Reson. Imaging*, 30 (2009), pp. 249–255, <http://dx.doi.org/10.1002/jmri.21854>.
- 720 [41] D. S. TUCH, T. G. REESE, M. R. WIEGELL, AND V. J. WEDEEN, Diffusion MRI of complex

- 721 neural architecture, *Neuron*, 40 (2003), pp. 885–895.
722 [42] S. WARACH, D. CHIEN, W. LI, M. RONTAL, AND R. R. EDELMAN, Fast magnetic resonance
723 diffusion-weighted imaging of acute human stroke, *Neurology*, 42 (1992), pp. 1717–, [http:](http://www.neurology.org/cgi/content/abstract/42/9/1717)
724 [//www.neurology.org/cgi/content/abstract/42/9/1717](http://www.neurology.org/cgi/content/abstract/42/9/1717).