



**HAL**  
open science

## Trefftz-DG Approximation for the Elasto-Acoustics

Hélène Barucq, Henri Calandra, Julien Diaz, Elvira Shishenina

► **To cite this version:**

Hélène Barucq, Henri Calandra, Julien Diaz, Elvira Shishenina. Trefftz-DG Approximation for the Elasto-Acoustics. Workshop de DIP, l'action stratégique INRIA TOTAL, Oct 2016, Houston, United States. hal-01416241

**HAL Id: hal-01416241**

**<https://inria.hal.science/hal-01416241>**

Submitted on 14 Dec 2016

**HAL** is a multi-disciplinary open access archive for the deposit and dissemination of scientific research documents, whether they are published or not. The documents may come from teaching and research institutions in France or abroad, or from public or private research centers.

L'archive ouverte pluridisciplinaire **HAL**, est destinée au dépôt et à la diffusion de documents scientifiques de niveau recherche, publiés ou non, émanant des établissements d'enseignement et de recherche français ou étrangers, des laboratoires publics ou privés.



# Trefftz-DG Approximation for the Elasto-Acoustics

DIP workshop

---

H.Barucq<sup>1</sup>, H.Calandra<sup>2</sup>, J.Diaz<sup>1</sup>, E.Shishenina<sup>1</sup>

December 14, 2016

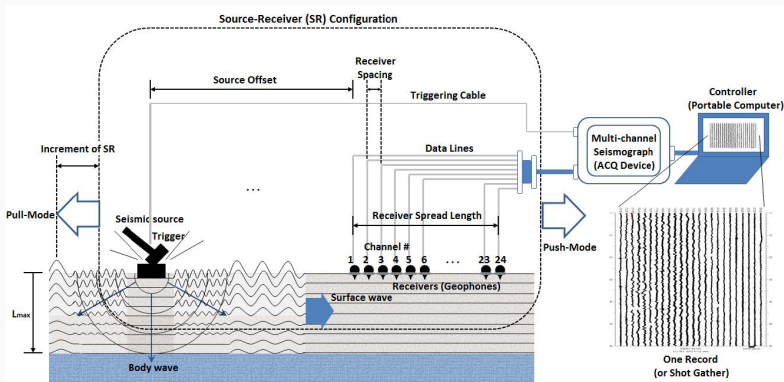
<sup>1</sup>Magique-3D, Inria Bordeaux-Sud-Ouest, <sup>2</sup>Total S.A.

# Abstract

---

# Seismic survey

Figure 1: Schematic of overall field setup for a seismic survey<sup>1</sup>.



<sup>1</sup> Park Seismic LLC. <http://www.parkseismic.com>. Internet resource.

# Basic numerical methods

Table 1: Generic properties of the most widely used numerical methods<sup>2</sup>.

Numerical method	Complex geometries	High-order accuracy and <i>hp</i> -adaptivity	Explicit semi-discrete form	Conservation laws	Elliptic problems
FDM	●	●	●	●	●
FVM	●	●	●	●	⊙
FEM	●	●	●	⊙	●
DG-FEM	●	●	●	●	⊙

<sup>2</sup> J.S.Hesthaven T.Warburton. Nodal discontinuous galerkin methods. Algorithms, analysis, and applications. Texts in Applied Mathematics, (54):1-370, 2007.

## DG-FEM :



- Adapted to the complex geometries ;  
High-order accuracy and  $hp$ -adaptivity ;  
Explicit semi-discrete form ;  
Conservation laws ;



- Higher number of degrees of freedom  
comparing to the methods with continuous approximation.

## Trefftz method <sup>3</sup> :

Given a region of an Euclidean space of some partitions of that region, a **Trefftz Method** is any procedure for solving boundary value problems of partial differential equations or systems of such equations, on such region, **using solutions of that differential equation or its adjoint**, defined in its subregions.

<sup>3</sup> I.Herrera. Trefftz method: a general theory. Instituto de Investigaciones en Matematicas Aplicadas y en Sistemas (IIMAS), pages 562-580, 2000.

## **Time-harmonic formulations :**

O.Cassenat, B.Despres (1998);

C.Farhat, I.Harari, U.Hetmaniuk (2003); G.Gabard (2007);

T.Huttunen, P.Monk, J.P.Kaipo (2002);

R.Tezaur, C.Farhat (2006);

## **Time-domain formulations :**

F.Kretzschmar, A.Moiola, I.Perugia (2015);

F.Kretzschmar, S.M.Schnepp, I.Tsukerman, T.Weiland(2014);

H.Egger, F.Kretzschmar, S.M.Schnepp, T.Weiland (2014).



## Expected advantages of Trefftz method :



Better orders of convergence ;

Flexibility in the choice of basis functions ;

Low dispersion ;

Incorporation of wave propagation directions in the discrete space ;

Adaptivity and local space-time mesh refinement.

<sup>3</sup> I.Herrera. Trefftz method: a general theory. Instituto de Investigaciones en Matematicas Aplicadas y en Sistemas (IIMAS), pages 562-580, 2000.

# **Mathematical formulation.**

## **Fluid case**

---

# Acoustic system. Problem equation

$\Omega_F \subset R^n$  - space domain ;

$I = (0, T)$  - time domain ;

$Q_F := \Omega_F \times I$  ;

$n_{Q_F} = (n_{Q_F}^x, n_{Q_F}^t)$  - o.p. unit normal vector on  $\partial Q_F$  ;

## Acoustic system

$$\frac{1}{c_f^2 \rho_f} \frac{\partial p}{\partial t} + \operatorname{div} v_f = f, \text{ in } Q_F;$$

$$\rho_f \frac{\partial v_f}{\partial t} + \nabla p = 0, \text{ in } Q_F;$$

$$v_f(\cdot, 0) = v_{f0}, \quad p(\cdot, 0) = p_0, \text{ on } \Omega_F;$$

$$v_f = g_f^D, \text{ on } \partial \Omega_F \times I.$$

$$K_F \subset Q_F (c_f, \rho_f \equiv \text{const. in } K_F) ;$$

$$n_{K_F} = (n_{K_F}^x, n_{K_F}^t) - \text{o.p. normal vector on } \partial K_F ;$$

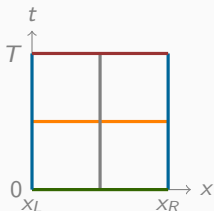
$$v_f, p \in H^1(K_F) ;$$

$$\omega_f, q \in H^1(K_F) ;$$

## Space-time integration

$$\begin{aligned} & - \int_{K_F} (v_f \cdot (\rho_f \frac{\partial \omega_f}{\partial t} + \nabla q) + p (\frac{1}{c_f^2 \rho_f} \frac{\partial q}{\partial t} + \text{div} \omega_f)) dv + \\ & + \int_{\partial K_F} ((p \omega_f + v_f q) \cdot n_{K_F}^x + (\frac{1}{c_f^2 \rho_f} p q + \rho_f v_f \cdot \omega_f) n_{K_F}^t) ds = \iint_{K_F} f q dv. \end{aligned}$$

## Mesh and DG-notation



$\mathcal{T}_h$  - mesh on  $Q_F := \Omega_F \times I$

$\mathcal{F}_h = \cup_{K_F \in \mathcal{T}_h} \partial K_F$  - mesh skeleton :

$\mathcal{F}_h^{\Omega_F} :=$  union of the internal  $\Omega$ -like faces, ( $t \equiv \text{const.}$ ) ;

$\mathcal{F}_h^{I_F} :=$  union of the internal  $I$ -like faces, ( $x \equiv \text{const.}$ ) ;

$\mathcal{F}_h^{0_F} := \Omega_F \times \{0\}$  ;

$\mathcal{F}_h^{T_F} := \Omega_F \times \{T\}$  ;

$\mathcal{F}_h^{D_F} := \partial\Omega_F \times [0, T]$  - union of the Dirichlet boundary faces.

# Acoustic system. Space-time DG formulation

Seek  $(v_{fh}, p_h) \in \mathbf{V}(\mathcal{T}_h) \subset H^1(\mathcal{T}_h)^2$ , s.t. for all  $K_F \in \mathcal{T}_h$ ,  $(\omega_f, q) \in \mathbf{V}(\mathcal{T}_h)$  it holds:

## DG formulation

$$\begin{aligned} & - \int_{K_F} \left[ p_h \left( \frac{1}{c_f^2 \rho_f} \frac{\partial q}{\partial t} + \operatorname{div} \omega_f \right) + v_{fh} \cdot \left( \rho_f \frac{\partial \omega_f}{\partial t} + \nabla q \right) \right] dv \\ & + \int_{\partial K_F} \left[ \left( \frac{1}{c_f^2 \rho_f} \hat{p}_h q + \rho_f \hat{v}_{fh} \cdot \omega_f \right) n_{K_F}^t + (\hat{p}_h \omega_f + \hat{v}_{fh} q) \cdot n_{K_F}^x \right] ds = \int_{K_F} f q dv. \end{aligned}$$

## Trefftz space

$$\mathbf{T}_F(\mathcal{T}_h) := \left\{ (\omega_f, q) \in H^1(\mathcal{T}_h)^2, \text{ s. t. in all } K_F \in \mathcal{T}_h \right. \\ \left. \rho_f \frac{\partial \omega_f}{\partial t} + \nabla q = 0, \frac{1}{c_f^2 \rho_f} \frac{\partial q}{\partial t} + \operatorname{div} \omega_f = 0 \right\}.$$

# Acoustic system. Space-time Trefftz-DG formulation

Seek  $(v_{fh}, p_h) \in \mathbf{V}(\mathcal{T}_h) \subset H^1(\mathcal{T}_h)^2$ , s.t. for all  $K_F \in \mathcal{T}_h$ ,  $(\omega_f, q) \in \mathbf{V}(\mathcal{T}_h)$  it holds:

**Trefftz-DG formulation (  $f \equiv 0$  )**

$$\int_{\partial K_F} \left[ \left( \frac{1}{c_f^2 \rho_f} \hat{p}_h q + \rho_f \hat{v}_{fh} \cdot \omega_f \right) n_{K_F}^t + (\hat{p}_h \omega_f + \hat{v}_{fh} q) \cdot n_{K_F}^x \right] ds = 0$$



Numerical flux  $\hat{v}_{fh}$  and  $\hat{\rho}_h$  :

$$\text{on } \mathcal{F}_h^{IF}: \quad \begin{pmatrix} \hat{v}_{fh} \\ \hat{\rho}_h \end{pmatrix} := \begin{pmatrix} \{v_{fh}\} + \beta \llbracket \rho_h \rrbracket_x \\ \{\rho_h\} + \alpha \llbracket v_{fh} \rrbracket_x \end{pmatrix},$$

$$\text{on } \mathcal{F}_h^{\Omega F}: \quad \begin{pmatrix} \hat{v}_{fh} \\ \hat{\rho}_h \end{pmatrix} := \begin{pmatrix} v_{fh}^- \\ \rho_h^- \end{pmatrix},$$

$$\text{on } \mathcal{F}_h^{TF}: \quad \begin{pmatrix} \hat{v}_{fh} \\ \hat{\rho}_h \end{pmatrix} := \begin{pmatrix} v_{fh} \\ \rho_h \end{pmatrix},$$

$$\text{on } \mathcal{F}_h^{0F}: \quad \begin{pmatrix} \hat{v}_{fh} \\ \hat{\rho}_h \end{pmatrix} := \begin{pmatrix} v_{f0} \\ \rho_0 \end{pmatrix},$$

$$\text{on } \mathcal{F}_h^{DF}: \quad \begin{pmatrix} \hat{v}_{fh} \\ \hat{\rho}_h \end{pmatrix} := \begin{pmatrix} g_{DF} \\ \rho_h + \alpha(v_{fh} - g_{DF}) \cdot n_{K_F}^x \end{pmatrix},$$

$(\alpha \in L^\infty(\mathcal{F}_h^{IF} \cup \mathcal{F}_h^{DF}), \beta \in L^\infty(\mathcal{F}_h^{IF})$  - positive flux parameters)

## Trefftz-DG formulation :

$$\begin{aligned}
 & \int_{\mathcal{F}_h^{\Omega_F}} \left[ \frac{1}{c_f^2 \rho_f} p_h^- [[q]]_t + \rho_f v_{fh}^- [[\omega_f]]_t \right] ds \\
 & + \int_{\mathcal{F}_h^{IF}} \left[ \{p_h\} [[\omega_f]]_x + \{v_{fh}\} [[q]]_x + \alpha [[v_{fh}]_x [[\omega_f]]_x + \beta [[p_h]_x [[q]]_x \right] ds \\
 & + \int_{\mathcal{F}_h^{TF}} \left[ \frac{1}{c_f^2 \rho_f} p_h q + \rho_f v_{fh} \cdot \omega_f \right] ds - \frac{1}{2} \int_{\mathcal{F}_h^{0F}} \left[ \frac{1}{c_f^2 \rho_f} p_h q + \rho_f v_{fh} \cdot \omega_f \right] ds \\
 & + \int_{\mathcal{F}_h^{DF}} \left[ \omega_f \cdot (p n_{K_F}^x + \alpha v_{fh}) \right] ds = \\
 & \frac{1}{2} \int_{\mathcal{F}_h^{0F}} \left[ \frac{1}{c_f^2 \rho_f} p_h q + \rho_f v_{fh} \cdot \omega_f \right] ds + \int_{\mathcal{F}_h^{DF}} \left[ g_{DF} (\alpha \omega_f - q \cdot n_{K_F}^x) \right] ds.
 \end{aligned}$$

Seek  $(v_{fh}, p_h) \in \mathbf{V}(\mathcal{T}_h) \subset \mathbf{T}_F(\mathcal{T}_h)$  s.t. for all  $(\omega_f, q) \in \mathbf{V}(\mathcal{T}_h)$  it holds:

### Trefftz-DG formulation

$$\mathcal{A}_{TDG_F}((v_{fh}, p_h); (\omega_f, q)) = \ell_{TDG_F}(\omega_f, q).$$

## Trefftz-DG formulation in terms of $L^2(\mathcal{T}_h)$ -norms

$$\begin{aligned} \mathcal{A}_{TDG_F}((\omega_f, q); (\omega_f, q)) := & \\ & \frac{1}{2} \left\| \left( \frac{1}{c_f^2 \rho_f} \right)^{1/2} \llbracket \mathbf{q} \rrbracket_t \right\|_{L^2(\mathcal{F}_h^{\Omega F})}^2 + \frac{1}{2} \left\| \rho_f^{1/2} \llbracket \omega_f \rrbracket_t \right\|_{L^2(\mathcal{F}_h^{\Omega F})}^2 \\ & + \left\| \alpha^{1/2} \llbracket \omega_f \rrbracket_x \right\|_{L^2(\mathcal{F}_h^{IF})}^2 + \left\| \beta^{1/2} \llbracket \mathbf{q} \rrbracket_x \right\|_{L^2(\mathcal{F}_h^{IF})}^2 \\ & + \frac{1}{2} \left\| \left( \frac{1}{c_f^2 \rho_f} \right)^{1/2} \mathbf{q} \right\|_{L^2(\mathcal{F}_h^{TF})}^2 + \frac{1}{2} \left\| \rho_f^{1/2} \omega_f \right\|_{L^2(\mathcal{F}_h^{TF})}^2 \\ & + \left\| \alpha^{1/2} \omega_f \right\|_{L^2(\mathcal{F}_h^{DF})}^2. \end{aligned}$$

**Norm**  $||| \cdot |||_{TDGF}$  in  $\mathbf{T}_F(\mathcal{T}_h)$

$$\begin{aligned} |||(\omega_f, \mathbf{q})|||_{TDGF}^2 &:= \frac{1}{2} \left\| \left( \frac{1}{c_f^2 \rho_f} \right)^{1/2} \llbracket \mathbf{q} \rrbracket_t \right\|_{L^2(\mathcal{F}_h^{\Omega F})}^2 + \frac{1}{2} \left\| \rho_f^{1/2} \llbracket \omega_f \rrbracket_t \right\|_{L^2(\mathcal{F}_h^{\Omega F})}^2 \\ &+ \left\| \alpha^{1/2} \llbracket \omega_f \rrbracket_x \right\|_{L^2(\mathcal{F}_h^{IF})}^2 + \left\| \beta^{1/2} \llbracket \mathbf{q} \rrbracket_x \right\|_{L^2(\mathcal{F}_h^{IF})}^2 \\ &+ \frac{1}{2} \left\| \left( \frac{1}{c_f^2 \rho_f} \right)^{1/2} \mathbf{q} \right\|_{L^2(\mathcal{F}_h^{TF})}^2 + \frac{1}{2} \left\| \rho_f^{1/2} \omega_f \right\|_{L^2(\mathcal{F}_h^{TF})}^2 \\ &+ \left\| \alpha^{1/2} \omega_f \right\|_{L^2(\mathcal{F}_h^{DF})}^2. \end{aligned}$$

## Coercivity of Trefftz-DG formulation

$$\mathcal{A}_{TDG_F}((\omega_f, q); (\omega_f, q)) = |||(\omega_f, q)|||_{TDG_F}^2, \quad \forall (\omega_f, q) \in \mathbf{T}_F(\mathcal{T}_h).$$

**Add-on norm  $||| \cdot |||_{TDG_F^*}$  in  $\mathbf{T}_F(\mathcal{T}_h)$**

$$\begin{aligned} |||(\omega_f, \mathbf{q})|||_{TDG_F^*}^2 &:= |||(\omega_f, \mathbf{q})|||_{TDG_F}^2 \\ &+ \|\rho_f^{1/2} \omega_f^-\|_{L^2(\mathcal{F}_h^{\Omega_F})}^2 + \left\| \left( \frac{1}{c_f^2 \rho_f} \right)^{1/2} \mathbf{q}^- \right\|_{L^2(\mathcal{F}_h^{\Omega_F})}^2 \\ &+ \|\beta^{-1/2} \{\omega_f\}\|_{L^2(\mathcal{F}_h^{I_F})}^2 + \|\alpha^{-1/2} \{\mathbf{q}\}\|_{L^2(\mathcal{F}_h^{I_F})}^2 \\ &+ \|\alpha^{-1/2} \omega_f\|_{L^2(\mathcal{F}_h^{D_F})}^2. \end{aligned}$$

## Continuity of Trefftz-DG formulation

$$|\mathcal{A}_{TDG_F}((v_f, p); (\omega_f, q))| \leq 2 \| (v_f, p) \|_{TDG_F^*} \| (\omega_f, q) \|_{TDG_F},$$

$$|\ell_{TDG_F}(\omega_f, q)| \leq \sqrt{2} \left[ \|\rho_f^{1/2} v_{f0}\|_{L^2(\mathcal{F}_h^{0F})}^2 + \left\| \left( \frac{1}{c_f^2 \rho_f} \right)^{1/2} p_0 \right\|_{L^2(\mathcal{F}_h^{0F})}^2 \right]^{1/2}.$$



## Well-posedness

$$\| (v_f - v_{fh}, p - p_h) \|_{TDG_F} \leq 3 \inf_{(\omega_f, q) \in \mathbf{V}(T_h)} \| (v_f - \omega_f, p - q) \|_{TDG_F^*}.$$

**Mathematical formulation.**

**Solid case**

---

# Elastodynamic system. Problem equation

$\Omega_S \subset R^n$  - space domain ;

$I = (0, T)$  - time domain ;

$Q_S := \Omega_S \times I$  ;

$n_{Q_S} = (n_{Q_S}^x, n_{Q_S}^t)$  - o.p. unit normal vector on  $\partial Q_S$  ;

## Elastodynamic system

$$\underline{\underline{\frac{\partial \underline{\underline{\sigma}}}{\partial t}}} - \underline{\underline{C}} \underline{\underline{\varepsilon}}(v_s) = 0 \text{ in } Q_S;$$

$$\rho_s \frac{\partial v_s}{\partial t} - \operatorname{div} \underline{\underline{\sigma}} = 0 \text{ in } Q_S;$$

$$v_s(\cdot, 0) = v_{s0}, \quad \underline{\underline{\sigma}}(\cdot, 0) = \underline{\underline{\sigma}}_0 \text{ on } \Omega_S;$$

$$v_s = g_{D_S} \text{ on } \partial \Omega_S \times I.$$

# Elastodynamic system. Problem equation

$\Omega_S \subset R^n$  - space domain ;

$I = (0, T)$  - time domain ;

$Q_S := \Omega_S \times I$  ;

$n_{Q_S} = (n_{Q_S}^x, n_{Q_S}^t)$  - o.p. unit normal vector on  $\partial Q_S$  ;

## Elastodynamic system

$$\underline{A} \frac{\partial \underline{\underline{\sigma}}}{\partial t} - \underline{\underline{\varepsilon}}(v_s) = 0 \text{ in } Q_S;$$

$$\rho_s \frac{\partial v_s}{\partial t} - \text{div} \underline{\underline{\sigma}} = 0 \text{ in } Q_S;$$

$$v_s(\cdot, 0) = v_{s0}, \underline{\underline{\sigma}}(\cdot, 0) = \underline{\underline{\sigma}}_0 \text{ on } \Omega_S;$$

$$v_s = g_{D_S} \text{ on } \partial \Omega_S \times I.$$

$$K_S \subset Q_S \quad (\underline{A}, \rho_s \equiv \text{const. in } K_S) ;$$

$$n_{K_S} = (n_{K_S}^x, n_{K_S}^t) - \text{o.p. unit normal vector on } \partial K_S ;$$

$$v_s, \underline{\sigma} \in H^1(K_S) ;$$

$$\omega_s, \underline{\xi} \in H^1(K_S) ;$$

## Space-time integration

$$\begin{aligned}
 & - \int_{K_S} \left[ \underline{\sigma} : \left( \underline{A} \frac{\partial \underline{\xi}}{\partial t} - \underline{\varepsilon}(\omega_s) \right) + v_s \cdot \left( \rho_s \frac{\partial \omega_s}{\partial t} - \text{div} \underline{\xi} \right) \right] dv \\
 & + \int_{\partial K_S} \left[ \left( \underline{A} \underline{\sigma} : \underline{\xi} + \rho_s v_s \cdot \omega_s \right) \cdot n_{K_S}^t - \left( v_s \cdot \underline{\xi} + \underline{\sigma} \cdot \omega_s \right) \cdot n_{K_S}^x \right] ds = 0.
 \end{aligned}$$

## Trefftz space

$$\mathbf{T}_S(\mathcal{T}_h) := \left\{ (\omega_s, \underline{\underline{\xi}}) \in H^1(\mathcal{T}_h)^2, \text{ s. t. in all } K_S \in \mathcal{T}_h \right. \\ \left. \rho_s \frac{\partial \omega_s}{\partial t} - \operatorname{div} \underline{\underline{\xi}} = 0, \underline{\underline{A}} \frac{\partial \underline{\underline{\xi}}}{\partial t} - \underline{\underline{\xi}}(\omega_s) = 0 \right\}.$$

Seek  $(v_{sh}, \underline{\underline{\sigma}}_h) \in \mathbf{V}(\mathcal{T}_h) \subset H^1(\mathcal{T}_h)^2$ , s.t. for all  $K_S \in \mathcal{T}_h$ ,  $(\omega_s, \underline{\underline{\xi}}) \in \mathbf{V}(\mathcal{T}_h)$  it holds:

## Space-time Trefftz-DG formulation

$$\int_{\partial K_S} \left[ (\underline{\underline{A}} \hat{\underline{\underline{\sigma}}}_h : \underline{\underline{\xi}} + \rho_s \hat{v}_{sh} \cdot w_s) \cdot n_K^t - (\hat{v}_{sh} \underline{\underline{\xi}} + \hat{\underline{\underline{\sigma}}}_h \omega_s) \cdot n_K^x \right] ds = 0$$

## Trefftz-DG formulation

$$\begin{aligned}
 & \int_{\mathcal{F}_h^{\Omega_S}} \left[ \underline{\underline{A}} \underline{\underline{\sigma}}_h^- : \underline{\underline{[\xi]}}_t + \rho_s v_{sh}^- \underline{\underline{[\omega_s]}}_t \right] ds \\
 & - \int_{\mathcal{F}_h^{I_S}} \left[ \{ \underline{\underline{\sigma}}_h \} \underline{\underline{[\omega_s]}}_x + \{ v_{sh} \} \underline{\underline{[\xi]}}_x - \gamma \underline{\underline{[v_{sh}]}}_x \underline{\underline{[\omega_s]}}_x - \delta \underline{\underline{[\sigma_h]}}_x \underline{\underline{[\xi]}}_x \right] ds \\
 & + \int_{\mathcal{F}_h^{T_S}} \left[ \underline{\underline{A}} \underline{\underline{\sigma}}_h : \underline{\underline{\xi}} + \rho_s v_{sh} \cdot \omega_s \right] ds - \frac{1}{2} \int_{\mathcal{F}_h^{0_S}} \left[ \underline{\underline{A}} \underline{\underline{\sigma}}_h : \underline{\underline{\xi}} + \rho_s v_{sh} \cdot \omega_s \right] ds \\
 & - \int_{\mathcal{F}_h^{D_S}} \left[ \underline{\underline{\xi}} (v_{sh} \cdot n_{K_S}^x - \delta \underline{\underline{\sigma}}_h) \right] ds = \\
 & \frac{1}{2} \int_{\mathcal{F}_h^{0_S}} \left[ \underline{\underline{A}} \underline{\underline{\sigma}}_h : \underline{\underline{\xi}} + \rho_s v_{sh} \cdot \omega_s \right] ds + \int_{\mathcal{F}_h^{D_S}} \left[ g_{D_S} (\omega_s \cdot n_{K_S}^x + \delta \underline{\underline{\xi}}) \right] ds.
 \end{aligned}$$



Seek  $(v_{sh}, \underline{\underline{\sigma}}_h) \in \mathbf{V}(\mathcal{T}_h) \subset \mathbf{T}_S(\mathcal{T}_h)$  s.t. for all  $(\omega_s, \underline{\underline{\xi}}) \in \mathbf{V}(\mathcal{T}_h)$  it holds:

## Trefftz-DG formulation

$$\mathcal{A}_{TDG_S}((v_{fh}, \underline{\underline{\sigma}}_h); (\omega_s, \underline{\underline{\xi}})) = \ell_{TDG_S}(\omega_s, \underline{\underline{\xi}}).$$

## Norms in $\mathbf{T}_S(\mathcal{T}_h)$

$$\begin{aligned}
 |||(\omega_s, \underline{\xi})|||_{TDG_S}^2 &:= \frac{1}{2} \left\| (\underline{\underline{A}})^{1/2} \llbracket \underline{\xi} \rrbracket_t \right\|_{L^2(\mathcal{F}_h^{\Omega_S})}^2 + \frac{1}{2} \left\| \rho_s^{1/2} \llbracket \omega_s \rrbracket_t \right\|_{L^2(\mathcal{F}_h^{\Omega_S})}^2 \\
 &+ \left\| \gamma^{1/2} \llbracket \omega_s \rrbracket_x \right\|_{L^2(\mathcal{F}_h^{I_S})}^2 + \left\| \delta^{1/2} \llbracket \underline{\xi} \rrbracket_x \right\|_{L^2(\mathcal{F}_h^{I_S})}^2 \\
 &+ \frac{1}{2} \left\| (\underline{\underline{A}})^{1/2} \underline{\xi} \right\|_{L^2(\mathcal{F}_h^{T_S})}^2 + \frac{1}{2} \left\| \rho_s^{1/2} \omega_s \right\|_{L^2(\mathcal{F}_h^{T_S})}^2 \\
 &+ \left\| \delta^{1/2} \underline{\xi} \right\|_{L^2(\mathcal{F}_h^{D_S})}^2.
 \end{aligned}$$

## Norms in $\mathbf{T}_S(\mathcal{T}_h)$

$$\begin{aligned} |||(\omega_s, \underline{\underline{\xi}})|||_{TDG_S^*}^2 &:= |||(\omega_s, \underline{\underline{\xi}})|||_{TDG_S}^2 \\ &+ \|\rho_s^{1/2} \omega_s^-\|_{L^2(\mathcal{F}_h^{\Omega_S})}^2 + \|(\underline{\underline{A}})^{1/2} \underline{\underline{\xi}}^-\|_{L^2(\mathcal{F}_h^{\Omega_S})}^2 \\ &+ \|\delta^{-1/2} \{\omega_s\}\|_{L^2(\mathcal{F}_h^{I_S})}^2 + \|\gamma^{-1/2} \{\underline{\underline{\xi}}\}\|_{L^2(\mathcal{F}_h^{I_S})}^2 \\ &+ \|\delta^{-1/2} \underline{\underline{\xi}}\|_{L^2(\mathcal{F}_h^{D_S})}^2. \end{aligned}$$

## Coercivity of Trefftz-DG formulation

$$\mathcal{A}_{TDG_S}((\omega_s, \underline{\underline{\xi}}); (\omega_s, \underline{\underline{\xi}})) = |||(\omega_s, \underline{\underline{\xi}})|||_{TDG_S}^2, \quad \forall (\omega_s, \underline{\underline{\xi}}) \in \mathbf{T}_S(\mathcal{T}_h).$$

## Continuity of Trefftz-DG formulation

$$|\mathcal{A}_{TDG_S}((\underline{v}_s, \underline{\sigma}); (\omega_s, \underline{\xi}))| \leq 2 \|(\underline{v}_s, \underline{\sigma})\|_{TDG_S^*} \|(\omega_s, \underline{\xi})\|_{TDG_S},$$

$$|\ell_{TDG_S}(\omega_s, \underline{\xi})| \leq \sqrt{2} \left[ \|\rho_s^{1/2} v_{s0}\|_{L^2(\mathcal{F}_h^{0s})}^2 + \|\underline{A}^{1/2} \underline{\sigma}_0\|_{L^2(\mathcal{F}_h^{0s})}^2 \right]^{1/2}.$$

## Well-posedness

$$\| (v_s - v_{sh}, \underline{\underline{\sigma}} - \underline{\underline{\sigma}}_h) \|_{TDG_S} \leq 3 \inf_{(\omega_s, \underline{\underline{\xi}}) \in \mathbf{V}(\mathcal{T}_h)} \| (v_s - \omega_s, \underline{\underline{\sigma}} - \underline{\underline{\xi}}) \|_{TDG_S^*}.$$

**Mathematical formulation.**  
**Fluid-solid case**

---

Representation of the **acoustic medium** as a limit case of an **elastic isotropic medium** with shear modulus  $\mu$  tending or equal to 0 ?



## Advantages of the numerical coupling:



Computing 1 unknown scalar pressure instead of 6 components of stress tensor ;

Avoiding presence of the numerical artifacts caused of the slow  $S$ -waves appearance.

## Acoustic system

$$\frac{1}{c_f^2 \rho_f} \frac{\partial p}{\partial t} + \operatorname{div} v_f = f, \text{ in } Q_F;$$

$$\rho_f \frac{\partial v_f}{\partial t} + \nabla p = 0, \text{ in } Q_F;$$

$$v_f = g_{D_F}, \text{ on } \partial\Omega_F \times I;$$

## Elastodynamic system

$$\underline{\underline{A}} \frac{\partial \underline{\underline{\sigma}}}{\partial t} - \underline{\underline{\varepsilon}}(v_s) = 0 \text{ in } Q_S;$$

$$\rho_s \frac{\partial v_s}{\partial t} - \operatorname{div} \underline{\underline{\sigma}} = 0 \text{ in } Q_S;$$

$$v_s = g_{D_S} \text{ on } \partial\Omega_S \times I;$$

### Fluid-solid transmission conditions through the $\Gamma_{FS}$

$$v_f \cdot n_{\Omega}^x = v_s \cdot n_{\Omega}^x \text{ on } \Gamma_{FS};$$

$$\underline{\underline{\sigma}} n_{\Omega}^x = -pn_{\Omega}^x \text{ on } \Gamma_{FS}.$$

## Trefftz space

$$\begin{aligned} \mathbf{T}(\mathcal{T}_h) := & \left\{ (\omega_f, q, \omega_s, \underline{\underline{\xi}}) \in H^1(\mathcal{T}_h)^4, \text{ s. t.} \right. \\ & \rho_f \frac{\partial \omega_f}{\partial t} + \nabla q = 0, \quad \frac{1}{c_f^2 \rho_f} \frac{\partial q}{\partial t} + \operatorname{div} \omega_f = 0, \quad \forall K_F \in \mathcal{T}_h, \\ & \left. \rho_s \frac{\partial \omega_s}{\partial t} - \operatorname{div} \underline{\underline{\xi}} = 0, \quad \frac{\partial A \underline{\underline{\xi}}}{\partial t} - \underline{\underline{\xi}}(\omega_s) = 0, \quad \forall K_S \in \mathcal{T}_h \right\}. \end{aligned}$$

## Coupled system. Space-time Trefftz-DG formulation

Seek  $(v_{fh}, p_h, v_{sh}, \underline{\underline{\sigma}}_h) \in \mathbf{V}(\mathcal{T}_h) \subset \mathbf{T}(\mathcal{T}_h)$ , s. t. for all  $K_F, K_S \in \mathcal{T}_h$ ,  
 $(\omega_f, q, \omega_s, \underline{\underline{\xi}}) \in \mathbf{V}(\mathcal{T}_h)$  it holds :

### Trefftz-DG formulation ( $f \equiv 0$ )

$$\int_{\partial K_F} \left[ \left( \frac{1}{c_f^2 \rho_f} \hat{p}_h q + \rho_f \hat{v}_{fh} \cdot \omega_f \right) n_{K_F}^t + (\hat{p}_h \omega_f + \hat{v}_{fh} q) \cdot n_{K_F}^x \right] ds = 0,$$

$$\int_{\partial K_S} \left[ (\underline{\underline{A}} \hat{\underline{\underline{\sigma}}}_h : \underline{\underline{\xi}} + \rho_s \hat{v}_{sh} \cdot w_s) \cdot n_K^t - (\hat{v}_{sh} \underline{\underline{\xi}} + \hat{\underline{\underline{\sigma}}}_h \omega_s) \cdot n_K^x \right] ds = 0$$

Numerical flux  $\hat{v}_{fh}$ ,  $\hat{v}_{sh}$ ,  $\hat{p}_h$  and  $\hat{\underline{\sigma}}_h$  through  $\mathcal{F}_h^{FS}$ :

$$\text{on } \mathcal{F}_h^{FS} : \quad \begin{pmatrix} \hat{v}_{fh} \cdot n_{K_F}^x \\ \hat{p}_h \\ \hat{v}_{sh} \\ \hat{\underline{\sigma}}_h \cdot n_{K_S}^x \end{pmatrix} := \begin{pmatrix} v_{sh} \cdot n_{K_F}^x \\ p + \alpha(v_{fh} - v_{sh}) \cdot n_{K_F}^x \\ v_{sh} - \delta(\underline{\underline{\sigma}}_h - p_h) \cdot n_{K_S}^x \\ -p_h n_{K_S}^x \end{pmatrix}$$

Seek  $(v_{fh}, p_h, v_{sh}, \underline{\underline{\sigma}}_h) \in \mathbf{V}(\mathcal{T}_h) \subset \mathbf{T}(\mathcal{T}_h)$  s.t.  $\forall (\omega_f, q, \omega_s, \underline{\underline{\xi}}) \in \mathbf{V}(\mathcal{T}_h)$  it holds:

### Trefftz-DG formulation

$$\mathcal{A}_{TDG}((v_{fh}, p_h, v_{sh}, \underline{\underline{\sigma}}_h); (\omega_f, q, \omega_s, \underline{\underline{\xi}})) = \ell_{TDG}(\omega_f, q, \omega_s, \underline{\underline{\xi}})$$

## Norms in $\mathbf{T}(\mathcal{T}_h)$

$$|||(\omega_f, \mathbf{q}, \omega_s, \underline{\underline{\xi}})|||_{TDG}^2 := |||(\omega_f, \mathbf{q})|||_{TDG_F}^2 + |||(\omega_s, \underline{\underline{\xi}})|||_{TDG_S}^2 + 2\|\delta^{1/2}\underline{\underline{\xi}}\|_{L^2(\mathcal{F}_h^{FS})}^2$$

$$|||(\omega_f, \mathbf{q}, \omega_s, \underline{\underline{\xi}})|||_{TDG^*}^2 := |||(\omega_f, \mathbf{q})|||_{TDG_F^*}^2 + |||(\omega_s, \underline{\underline{\xi}})|||_{TDG_S^*}^2 + \frac{1}{2}\|\delta^{-1/2}\underline{\underline{\xi}}\|_{L^2(\mathcal{F}_h^{FS})}^2$$



## Coercivity of Trefftz-DG formulation

$$\mathcal{A}_{TDG}((\omega_f, \mathbf{q}, \omega_s, \underline{\underline{\xi}}); (\omega_f, \mathbf{q}, \omega_s, \underline{\underline{\xi}})) = |||(\omega_f, \mathbf{q}, \omega_s, \underline{\underline{\xi}})|||_{TDG}^2$$

## Continuity of Trefftz-DG formulation

$$|\mathcal{A}_{TDG}((\mathbf{v}_f, \mathbf{p}, \mathbf{v}_s, \underline{\underline{\sigma}}); (\omega_f, \mathbf{q}, \omega_s, \underline{\underline{\xi}}))| \leq 2 |||(\mathbf{v}_f, \mathbf{p}, \mathbf{v}_s, \underline{\underline{\sigma}})|||_{TDG} * |||(\omega_f, \mathbf{q}, \omega_s, \underline{\underline{\xi}})|||_{TDG},$$

$$|\ell_{TDG}(\omega_f, \mathbf{q}, \omega_s, \underline{\underline{\xi}})| \leq \sqrt{2} \left[ \|\rho_f^{1/2} \mathbf{v}_{f0}\|_{L^2(\mathcal{F}_h^{0F})}^2 + \left\| \left( \frac{1}{c_f^2 \rho_f} \right)^{1/2} \mathbf{p}_0 \right\|_{L^2(\mathcal{F}_h^{0F})}^2 \right. \\ \left. + \|\rho_s^{1/2} \mathbf{v}_{s0}\|_{L^2(\mathcal{F}_h^{0S})}^2 + \|\underline{\underline{A}}^{1/2} \underline{\underline{\sigma}}_0\|_{L^2(\mathcal{F}_h^{0S})}^2 \right]^{1/2}.$$

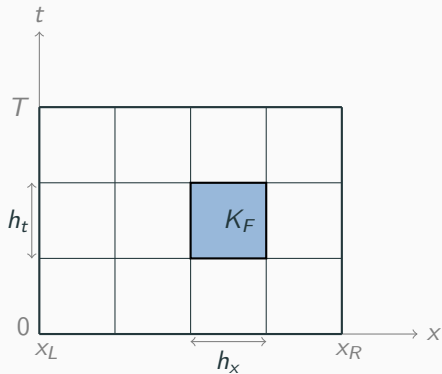
## Well-posedness

$$\begin{aligned} & |||(v_f - v_{fh}, p - p_h, v_s - v_{sh}, \underline{\underline{\sigma}} - \underline{\underline{\sigma}}_h)|||_{TDG} \\ & \leq 3 \inf_{(\omega_f, q, \omega_s, \underline{\underline{\xi}}) \in \mathbf{v}(\mathcal{T}_h)} |||(v_f - \omega_f, p - q, v_s - \omega_s, \underline{\underline{\sigma}} - \underline{\underline{\xi}})|||_{TDG^*}. \end{aligned}$$

# **Implementation of the algorithm. Acoustic system**

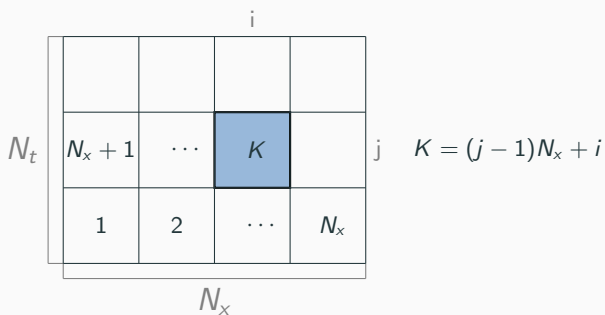
---

# Implementation of the algorithm



**Figure 2:** Rectangular mesh on  $Q_F := [x_L, x_R] \times [0, T]$ .

# Implementation of the algorithm



**Figure 3:** Element numbering.

# Implementation of the algorithm

Seek  $(v_{fh}, p_h) \in \mathbf{V}(\mathcal{T}_h) \subset \mathbf{T}_F(\mathcal{T}_h)$  s.t. for all  $(\omega_f, q) \in \mathbf{V}(\mathcal{T}_h)$  it holds:

## Treftz-DG formulation

$$\begin{aligned} & \int_{\mathcal{F}_h^{\Omega_F}} \left[ \frac{1}{c_f^2 \rho_f} p_h^- \llbracket q \rrbracket_t + \rho_f v_{fh}^- \llbracket \omega_f \rrbracket_t \right] ds \\ & + \int_{\mathcal{F}_h^{I_F}} \left[ \{p_h\} \llbracket \omega_f \rrbracket_x + \{v_{fh}\} \llbracket q \rrbracket_x + \alpha \llbracket v_{fh} \rrbracket_x \llbracket \omega_f \rrbracket_x + \beta \llbracket p_h \rrbracket_x \llbracket q \rrbracket_x \right] ds \\ & + \int_{\mathcal{F}_h^{T_F}} \left[ \frac{1}{c_f^2 \rho_f} p_h q + \rho_f v_{fh} \cdot \omega_f \right] ds = \int_{\mathcal{F}_h^{0_F}} \left[ \frac{1}{c_f^2 \rho_f} p_0 q + \rho_f v_{f0} \cdot \omega_f \right] ds. \end{aligned}$$

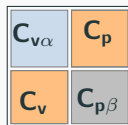
# Implementation of the algorithm

Treftz-DG formulation. 1<sup>st</sup> layer

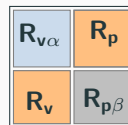
$$\begin{aligned} & [v_{K-1} \cdot \mathbf{L}_{v\alpha} + p_{K-1} \cdot \mathbf{L}_p] + [v_K \cdot \mathbf{C}_{v\alpha} + p_K \cdot \mathbf{C}_p] + [v_{K+1} \cdot \mathbf{R}_{v\alpha} + p_{K+1} \cdot \mathbf{R}_p] \\ & [v_{K-1} \cdot \mathbf{L}_v + p_{K-1} \cdot \mathbf{L}_{p\beta}] + [v_K \cdot \mathbf{C}_v + p_K \cdot \mathbf{C}_{p\beta}] + [v_{K+1} \cdot \mathbf{R}_v + p_{K+1} \cdot \mathbf{R}_{p\beta}] \end{aligned}$$



"Left" block



"Central" block



"Right" block

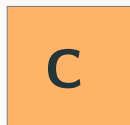
# Implementation of the algorithm

Treftz-DG formulation. 1<sup>st</sup> layer

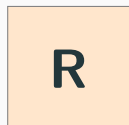
$$\begin{aligned} & [v_{K-1} \cdot \mathbf{L}_{v\alpha} + p_{K-1} \cdot \mathbf{L}_p] + [v_K \cdot \mathbf{C}_{v\alpha} + p_K \cdot \mathbf{C}_p] + [v_{K+1} \cdot \mathbf{R}_{v\alpha} + p_{K+1} \cdot \mathbf{R}_p] \\ & [v_{K-1} \cdot \mathbf{L}_v + p_{K-1} \cdot \mathbf{L}_{p\beta}] + [v_K \cdot \mathbf{C}_v + p_K \cdot \mathbf{C}_{p\beta}] + [v_{K+1} \cdot \mathbf{R}_v + p_{K+1} \cdot \mathbf{R}_{p\beta}] \end{aligned}$$



"Left" block



"Central" block



"Right" block



# Implementation of the algorithm

$$\begin{bmatrix} \boxed{C} & \boxed{R} & & \dots & & \boxed{L} \\ \boxed{L} & \boxed{C} & \boxed{R} & & & \\ & \boxed{L} & \boxed{C} & \boxed{R} & & \\ \vdots & & & \ddots & & \vdots \\ & & & & \boxed{L} & \boxed{C} & \boxed{R} \\ \boxed{R} & & \dots & & \boxed{L} & \boxed{C} \end{bmatrix} \cdot \begin{bmatrix} \boxed{U_1} \\ \boxed{U_2} \\ \boxed{U_3} \\ \vdots \\ \boxed{U_{N-2}} \\ \boxed{U_{N-1}} \end{bmatrix} = \begin{bmatrix} \boxed{U_1^0} \\ \boxed{U_2^0} \\ \boxed{U_3^0} \\ \vdots \\ \boxed{U_{N-2}^0} \\ \boxed{U_{N-1}^0} \end{bmatrix}$$

## Implementation of the algorithm

$$\begin{bmatrix} \text{M} \\ 32N_x \times 32N_x \end{bmatrix} \cdot \begin{bmatrix} \text{U} \\ 1 \times 32N_x \end{bmatrix} = \begin{bmatrix} \text{U}^0 \\ 1 \times 32N_x \end{bmatrix}$$

# Implementation of the algorithm

## 1. Initialization

$$\begin{bmatrix} \mathbf{M} \end{bmatrix} ; \begin{bmatrix} \mathbf{invM} \end{bmatrix} ; \begin{bmatrix} \mathbf{U}^0 \end{bmatrix} ;$$

## 2. Propagation

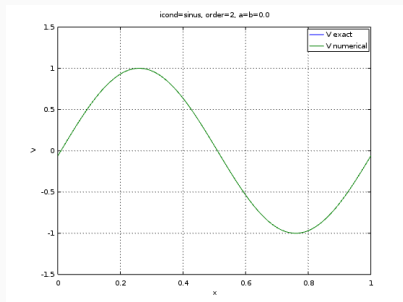
For  $t = 1 : N_t$

$$\begin{bmatrix} \mathbf{U} \end{bmatrix} = \begin{bmatrix} \mathbf{invM} \end{bmatrix} \cdot \begin{bmatrix} \mathbf{U}^0 \end{bmatrix} ;$$

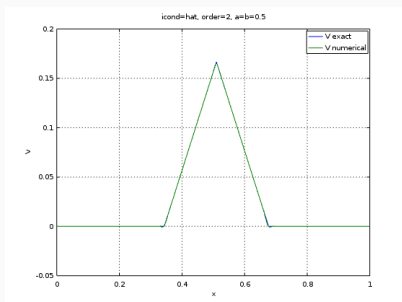
$$\begin{bmatrix} \mathbf{U}^0 \end{bmatrix} = \begin{bmatrix} \mathbf{U} \end{bmatrix} ;$$

end

# Implementation of the algorithm

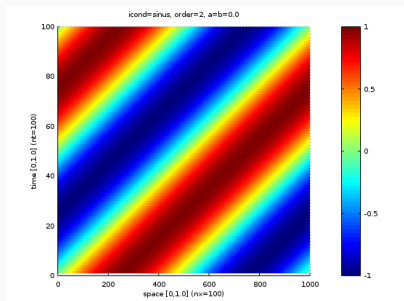


**Figure 4:** Exact and approximate solution for velocity  $v_f(x, t)$ ,  $t = \Delta t \times 1$ , on the first time-layer ( $\alpha = \beta = 0.5$ ).

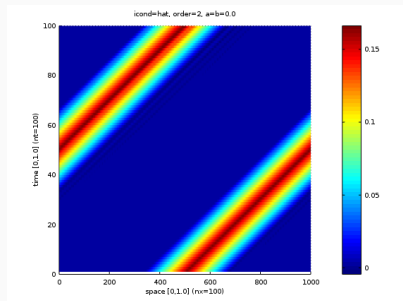


**Figure 5:** Exact and approximate solution for velocity  $v_f(x, t)$ ,  $t = \Delta t \times 1$ , on the first time-layer ( $\alpha = \beta = 0.5$ ).

# Implementation of the algorithm

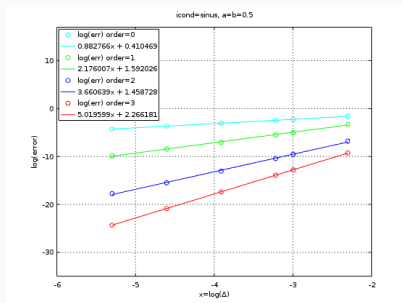


**Figure 6:** Time propagation of the approximate solution for velocity  $v_f(x, t)$  ( $\alpha = \beta = 0.5$ ).

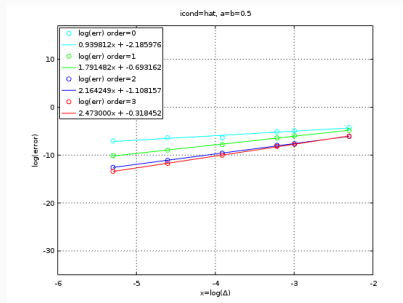


**Figure 7:** Time propagation of the approximate solution for velocity  $v_f(x, t)$  ( $\alpha = \beta = 0.5$ ).

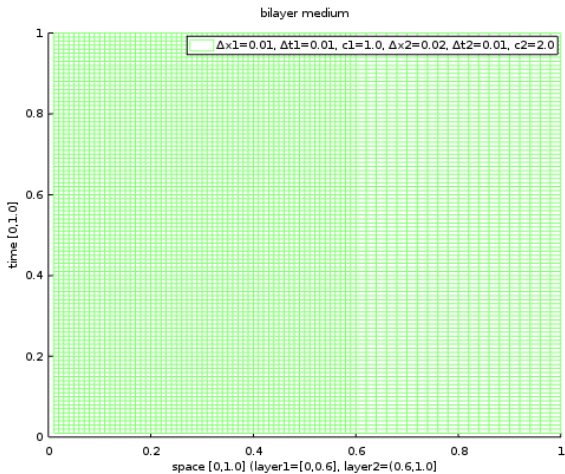
# Implementation of the algorithm



**Figure 8:** Convergence of numerical solution for velocity  $v_f(x, t)$  in logarithmic scale ( $\alpha = \beta = 0.5$ ).



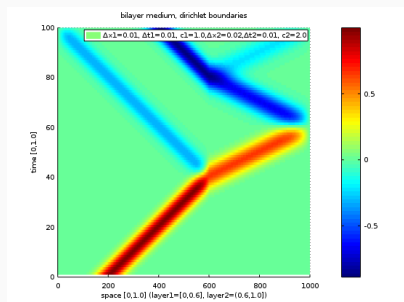
**Figure 9:** Convergence of numerical solution for velocity  $v_f(x, t)$  in logarithmic scale ( $\alpha = \beta = 0.5$ ).



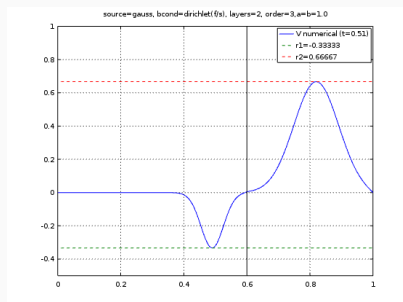
**Figure 10:** Mesh for heterogeneous case (bilayer medium).

$\Delta x_1 = 0.01$ ,  $\Delta t_1 = 0.01$ ,  $c_1 = 1.0$ ,  $\Delta x_2 = 0.02$ ,  $\Delta t_2 = 0.01$ ,  $c_1 = 2.0$ .

# Implementation of the algorithm



**Figure 11:** Approximate solution for velocity  $v(x, t)$ .



**Figure 12:** Approximate solution for velocity  $v(x, t)$ ,  $t = \Delta t \times 51$ .



## Conclusion

---

## On-going work :



Numerical implementation of the method for 1D AS ;  
Different choice of the basis functions ;  
Analysis of efficiency of the method / algorithm / code.

## Perspectives :



Numerical implementation of the method for ES 1D,2D,3D ;  
Numerical coupling 1D,2D,3D ;  
Coupling Trefftz-DG in solid with FVM in fluid,  
integrating of the transmission layer.

J.S.Hesthaven T.Warburton. Nodal discontinuous galerkin methods. Algorithms, analysis, and applications. Texts in Applied Mathematics, (54):1370, 2007.

F.Kretschmar A.Moiola I.Perugia. A priori error analysis of space-time trefftz discontinuous galerkin methods for wave problems. arXiv:1501.05253v2(math.NA), 2015.

O.C.Zienkiewicz. Trefftz type approximation and the generalized finite element method - history and development. Comp Ass Mech and Eng Sci, (4):305316, 1997.

I.Herrera. Trefftz method: a general theory. Instituto de Investigaciones en Matematicas Aplicadas y en Sistemas (IIMAS), pages 562580, 2000.

A.Maciag. Wave polynomials in elasticity problems. Department of Mathematics, Kielce University of Technology. AI.1000-lecia P.P.7, 2006

**Thank you for your attention!**

**Questions?**

# Implementation of the algorithm

## Polynomial waves basis functions

- Generating functions  $g^V(x, t)$  and  $g^P(x, t)$  - solution of wave equation if  $a^2 = b^2$

$$g^V(a, b, x, t) = e^{i(ax+bc_f t)}, \quad g^P(a, b, x, t) = -c_f e^{i(bx+ac_f t)}.$$

- Taylor expansions for  $g^V(x, t)$ ,  $g^P(x, t)$  ( $a^2 = b^2$ ):

$$e^{i(ax+bc_f t)} = \sum_{n=0}^{\infty} \sum_{k=0, k < 2}^n Q_{n-k, k}^V(x, t) a^{n-k} b^k,$$
$$-c_f e^{i(bx+ac_f t)} = \sum_{n=0}^{\infty} \sum_{k=0, k < 2}^n Q_{n-k, k}^P(x, t) a^{n-k} b^k.$$

$$R_{n-k, k}^V(x, t) = \Re(Q_{n-k, k}^V(x, t)), \quad I_{n-k, k}^V(x, t) = \Im(Q_{n-k, k}^V(x, t))$$
$$R_{n-k, k}^P(x, t) = \Re(Q_{n-k, k}^P(x, t)), \quad I_{n-k, k}^P(x, t) = \Im(Q_{n-k, k}^P(x, t)).$$

# Implementation of the algorithm

## Polynomial waves basis functions 1D

$$\begin{array}{llll} \phi_1^v = 0 & \phi_2^v = 1 & \phi_3^v = x & \phi_4^v = c_f t \\ \phi_5^v = -\frac{x^2}{2} - \frac{c_f^2 t^2}{2} & \phi_6^v = -c_f x t & \phi_7^v = -\frac{x^3}{6} - \frac{x c_f^2 t^2}{2} & \phi_8^v = -\frac{c_f^3 t^3}{6} - \frac{x^2 c_f t}{2} \\ \\ \phi_1^p = -c_f & \phi_2^p = 0 & \phi_3^p = -c_f^2 t & \phi_4^p = -c_f x \\ \phi_5^p = c_f^2 x t & \phi_6^p = c_f \left( \frac{x^2}{2} + \frac{c_f^2 t^2}{2} \right) & \phi_7^p = c_f \left( \frac{c_f^3 t^3}{6} + \frac{x^2 c_f t}{2} \right) & \phi_8^p = c_f \left( \frac{x^3}{6} + \frac{x c_f^2 t^2}{2} \right). \end{array}$$



# Implementation of the algorithm

## Polynomial waves basis functions 2D

<b>p = 0</b>		
$\phi_1^{vx} = 0$ $\phi_2^{vx} = 1$	$\phi_1^{vy} = 0$ $\phi_2^{vy} = 1$	$\phi_1^p = -c_f$ $\phi_2^p = 0$
<b>p = 1</b>		
$\phi_3^{vx} = x$ $\phi_4^{vx} = c_f t$ $\phi_5^{vx} = y$	$\phi_3^{vy} = y$ $\phi_4^{vy} = x$ $\phi_5^{vy} = c_f t$	$\phi_3^p = -c_f(c_f t)$ $\phi_4^p = -c_f x$ $\phi_5^p = -c_f y$
<b>p = 2</b>		
$\phi_7^{vx} = -\frac{x^2}{2} - \frac{y^2}{2} - \frac{c_f^2 t^2}{2}$ $\phi_8^{vx} = -xy$ $\phi_9^{vx} = -c_f t y$ $\phi_{10}^{vx} = -c_f t x$	$\phi_7^{vy} = -xy$ $\phi_8^{vy} = -\frac{x^2}{2} - \frac{y^2}{2} - \frac{c_f^2 t^2}{2}$ $\phi_9^{vy} = -c_f t x$ $\phi_{10}^{vy} = -c_f t y$	$\phi_7^p = c_f(c_f t x)$ $\phi_8^p = c_f(c_f t y)$ $\phi_9^p = c_f(x y)$ $\phi_{10}^p = c_f\left(\frac{x^2}{2} + \frac{y^2}{2} + \frac{c_f^2 t^2}{2}\right)$
<b>p = 3</b>		
$\phi_{11}^{vx} = -\frac{x^2 y}{2} - \frac{c_f^2 t^2 y}{2} - \frac{y^3}{6}$ $\phi_{12}^{vx} = -c_f t x y$ $\phi_{13}^{vx} = -\frac{c_f^3 t^3}{6} - \frac{c_f t x^2}{2} - \frac{c_f t y^2}{2}$ $\phi_{14}^{vx} = -\frac{x y^2}{2} - \frac{c_f^2 t^2 x}{2} - \frac{x^3}{6}$	$\phi_{11}^{vy} = -\frac{x y^2}{2} - \frac{c_f^2 t^2 x}{2} - \frac{x^3}{6}$ $\phi_{12}^{vy} = -\frac{c_f^3 t^3}{6} - \frac{c_f t x^2}{2} - \frac{c_f t y^2}{2}$ $\phi_{13}^{vy} = -c_f t y$ $\phi_{14}^{vy} = -\frac{x^2 y}{2} - \frac{c_f^2 t^2 y}{2} - \frac{y^3}{6}$	$\phi_{11}^p = c_f(c_f t x y)$ $\phi_{12}^p = c_f\left(\frac{x^2 y}{2} + \frac{c_f^2 t^2 y}{2} + \frac{y^3}{6}\right)$ $\phi_{13}^p = c_f\left(\frac{x y^2}{2} + \frac{c_f^2 t^2 x}{2} + \frac{x^3}{6}\right)$ $\phi_{14}^p = c_f\left(\frac{c_f^3 t^3}{6} + \frac{c_f t x^2}{2} + \frac{c_f t y^2}{2}\right)$