



**HAL**  
open science

## Abbreviation Method for Some Jointed Relations in Displaying Genealogy

Seiji Sugiyama, Daisuke Yokozawa, Atsushi Ikuta, Satoshi Hiratsuka, Susumu Saito, Miyuki Shibata, Tohru Matsuura

► **To cite this version:**

Seiji Sugiyama, Daisuke Yokozawa, Atsushi Ikuta, Satoshi Hiratsuka, Susumu Saito, et al.. Abbreviation Method for Some Jointed Relations in Displaying Genealogy. 13th IFIP International Conference on Computer Information Systems and Industrial Management (CISIM), Nov 2014, Ho Chi Minh City, Vietnam. pp.339-350, 10.1007/978-3-662-45237-0\_32 . hal-01405604

**HAL Id: hal-01405604**

**<https://inria.hal.science/hal-01405604>**

Submitted on 30 Nov 2016

**HAL** is a multi-disciplinary open access archive for the deposit and dissemination of scientific research documents, whether they are published or not. The documents may come from teaching and research institutions in France or abroad, or from public or private research centers.

L'archive ouverte pluridisciplinaire **HAL**, est destinée au dépôt et à la diffusion de documents scientifiques de niveau recherche, publiés ou non, émanant des établissements d'enseignement et de recherche français ou étrangers, des laboratoires publics ou privés.



Distributed under a Creative Commons Attribution 4.0 International License

# Abbreviation Method for Some Jointed Relations in Displaying Genealogy

Seiji Sugiyama<sup>1</sup>, Daisuke Yokozawa<sup>2</sup>, Atsushi Ikuta<sup>2</sup>, Satoshi Hiratsuka<sup>1</sup>,  
Susumu Saito<sup>3</sup>, Miyuki Shibata<sup>2</sup>, and Tohru Matsuura<sup>4</sup>

<sup>1</sup> Ritsumeikan University, Kusatsu, Shiga, JAPAN,

seijisan@hr.ci.ritsumei.ac.jp, hiratsuka@spice.ci.ritsumei.ac.jp

<sup>2</sup> Otani University, Kyoto, JAPAN,

dyokozawa@gmail.com, a.ikuta@sch.otani.ac.jp, neko@res.otani.ac.jp

<sup>3</sup> Institute of Land Use Reorganization, Kyoto, JAPAN,

ssm3110@gmail.com

<sup>4</sup> Hokkaido University Hospital, Sapporo, Hokkaido, JAPAN,

macchan@med.hokudai.ac.jp

**Abstract.** In this research, a new method, named “Joint ABBReviAtion for Organizing WHItEBasE (JaBBRoW)”, for abbreviating some jointed relations in displaying genealogy using our previous WHItEBasE method, is proposed. The WHItEBasE method has perfectly been able to integrate each relation that includes a married couple and their children, and has been able to display various complex relations with segment intersections easily. This method has a problem that all of inputted layouts are always displayed. The solution is to use the JaBBRoW. It is a hidden boundary that can organize information of some positions using a square area that is set by user’s requirements to abbreviate. Not only the area is movable but also its scale can be compacted and recovered seamlessly by only mouse operations. As a result, arbitrary relations with horizontal and vertical connections in genealogy can be abbreviated easily. Our software that can display genealogy with abbreviation is presented.

**Keywords:** Family Trees, Pedigrees, GEDCOM, WHItEBasE

## 1 Introduction

In genealogy on paper media, it is natural to write one individual only once using segment intersections even if there are complex relations that include multiple remarriages with children. This simple rule makes easy to understand all of complex relations at a glance. In contrast, almost all of existing genealogy display software often display one individual in multiple places when complex relations are inputted [1]-[21]. The displaying results cause confusion to understand the correct relations. They consider only simple family trees and have no idea to display complex relations because GEDCOM [22], a de facto standard for recording genealogy data exchange format, considers no layout information.

To cope with this difficulty, new genealogy display software has already been constructed on our previous research by using the WHItEBasE (Widespread

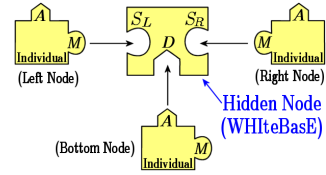
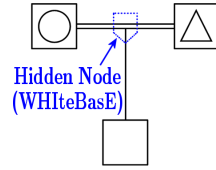

**Fig. 1.** A regular family layout in genealogy **Fig. 2.** Connection model of WHiteBasE

Hands to InTErconnect BASic Elements) method [23]-[25]. The WHiteBasE is a hidden node for integrating relations that include not only a married couple and their children but also information of those positions. As a result, one individual have been displayed only once using segment intersections easily. In addition, not only various layouts such as paper media have been displayed but also intuitive inputs and inspections such as map display systems have been realized.

On the other hand, there is a requirement to abbreviate some jointed relations in genealogy on restrictions of displaying area, or the convenience of explanation. In this case, it is needed that not only the inputted information of relations is maintained but also the users can always find which relations are abbreviated. No software realizes this requirement.

New algorithm for abbreviating a part of relations in genealogy is necessary because all of inputted layouts are always displayed on the WHiteBasE method. In this research, a new method, “Joint ABBReviation for Organizing WHiteBasE (JaBBRoW)”, is proposed so that it can solve this problem. The JaBBRoW is a hidden boundary that can organize information of some positions using a square area that is set by user’s requirements to abbreviate. Not only the area is movable but also its scale can be compacted and recovered seamlessly by only mouse operations. As a result, arbitrary relations with horizontal and vertical connections in genealogy can be abbreviated easily. Our software that can display genealogy with abbreviation is presented.

## 2 WHiteBasE

In this section, the WHiteBasE method that is our previous proposal [23]-[25] is briefly introduced. A regular family relation between a married couple and their child is managed as an event by a Hidden Node, WHiteBasE as shown in Fig. 1. The connection model of WHiteBasE is shown in Fig. 2. WHiteBasE has three keyholes,  $S_L$ ,  $S_R$  (Substance) and  $D$  (Descendant). Individuals have two keys,  $A$  (Ascendant) and  $M$  (Marriage).  $A$  can connect with  $D$ , and  $M$  can connect with  $S_L$  or  $S_R$ , where denote one family.

For brothers and sisters,  $D$  is extended to multiple keyholes  $D_j$  as shown in Fig. 3. For multiple remarriages,  $M$  is extended to multiple keys  $M_k$  and plural WHiteBasEs are used as shown in Fig. 4. For adoptions,  $A$  is extended to multiple keys  $A_l$  as shown in Fig. 5 where  $A_p$ , one of  $A_l$ , denotes ID for handling the biological parents, and the others denote IDs for handling social parents.

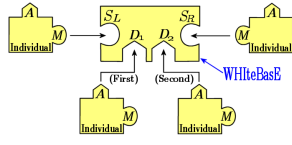

Fig. 3. Brothers and sisters

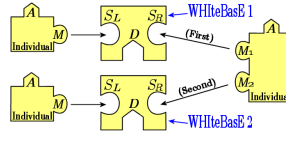

Fig. 4. Multiple Remarriages

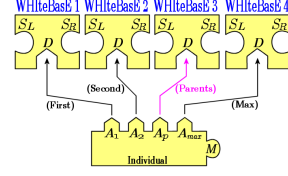

Fig. 5. Adoptions

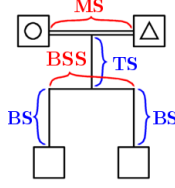

Fig. 6. Regular layout

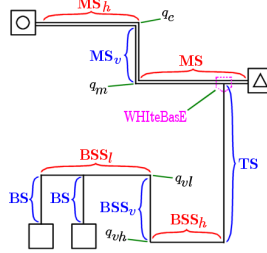

Fig. 7. Various Layouts

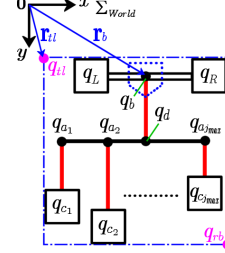

Fig. 8. Coordinate System

Fig. 6 shows the regular Japanese layout style. It includes a double horizontal segment MS (Marriage Segment), a vertical segment TS (Trunk Segment), a horizontal segment BSS (Brothers and Sisters Segment), and a vertical segment BS (Branch Segment). The ‘ $\Delta$ ’ denotes a male, and the ‘ $\circ$ ’ denotes a female that are a couple connected by using MS. For various layouts, MS is extended to MS, MS<sub>v</sub>, and MS<sub>h</sub> named DB (Double Bend), and BSS is extended to BSS<sub>h</sub>, BSS<sub>v</sub>, and BSS<sub>l</sub> named HS (Hooked Segment), as shown in Fig. 7.

A set of  $W_i$  that defines WHItEBasEs and a set of  $I_j$  that defines Individual Nodes are represented by

$$W_i = \{S_L, S_R, D_j, \mathbf{Q}\} \quad \begin{cases} i = 0, 1, \dots, i_{max} \\ j = 0, 1, \dots, j_{max} \\ k = 0, 1, \dots, k_{max} \\ l = 0, 1, \dots, p, \dots, l_{max} \end{cases} \quad (1)$$

where  $i, j, k, l$  and  $i_{max}, j_{max}, k_{max}, l_{max}$  denote the IDs and their maximum values on the data table respectively,  $p$  denotes the ID for handling a biological parents,  $S_L$  and  $S_R$  denote the IDs for handling a couple,  $D_j$  denote the IDs for handling descendants,  $M_k$  denote the IDs for handling marriages, and  $A_l$  denote the IDs for handling ascendants. Individuals are managed by using data table including names and annotation data. WHItEBasEs are managed by using data table separated from Individuals.

A set of  $\mathbf{Q}$  that defines coordinate values for each position managed by a WHItEBasE measured from the origin in the displaying area is represented by

$$\mathbf{Q} = \{q_b, q_L, q_R, q_d, q_{c_j}, q_{a_j}, q_{vl}, q_{vh}, q_m, q_e, q_{tl}, q_{rb}\} \quad (2)$$

where  $q_b$  denotes the WHItEBasE's position,  $q_L, q_R$  denote the parents' positions,  $q_d$  denotes a junction's position between MS and TS,  $q_{c_j}$  denotes children's

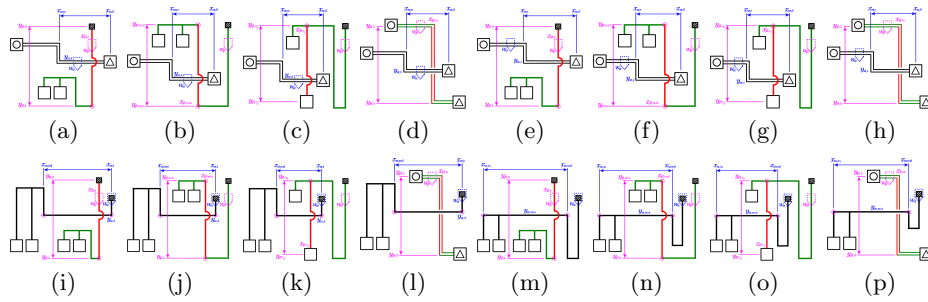

Fig. 9. Search pattern of segment intersections for various layouts

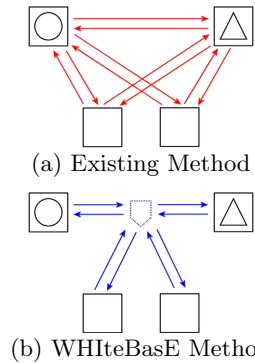

Fig. 10. Number of references

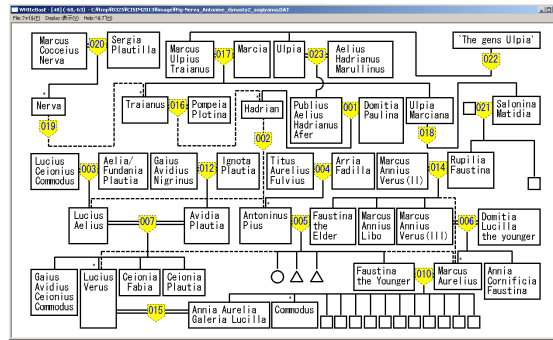

Fig. 11. Displaying Result by using WHIteBasE [26]

positions,  $q_{a_j}$  denotes junctions' positions between BSS and BS,  $q_{vl}, q_{vh}$  denote the corners on DB,  $q_m, q_e$  denote the corners on HS,  $q_{tl}, q_{rb}$  denote positions of top-left and bottom-right of all area managed by a WHIteBasE, as shown in Fig. 7 and Fig. 8.

There are only four kinds of horizontal segments and four kinds of vertical segments in the WHIteBasE method. The positions of segment intersections can be calculated by using only 16 patterns of line crossing as shown in Figs. 9(a)-(p). The half arcs are displayed on the positions of segment intersections. The detailed information has already been written in our previous research [25].

This algorithm is very fast because it skips when two WHIteBasEs' areas do not overlap. In addition, when adoptions are set, the segment style changes to the dashed segments named AS (Adopted Segment) and the arcs are not used.

One of advantages using WHIteBasE is the decreased reference volume. If the existing software is used, all of individuals connect with other individuals as shown in Fig. 10(a). In contrast, if the WHIteBasE is used, two reference links per a child decrease as shown in Fig. 10(b). Moreover, the users can understand the complex relations intuitively and can input and inspect them easily.

Fig. 11 shows the sample demonstrations by using our previous genealogy display software that can display complex relations with segment intersections automatically and seamlessly by only mouse operation [26].

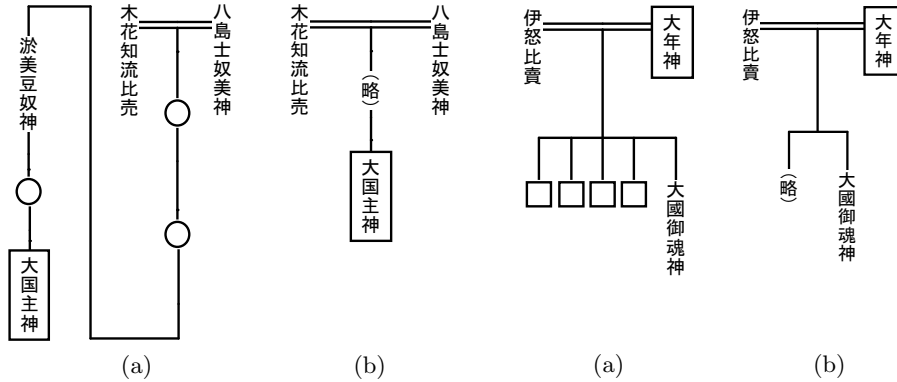

Fig. 12. Abbreviation of Generations

Fig. 13. Abbreviation of Brothers/Sisters

### 3 Genealogy with Abbreviation

First of all, it is considered what is abbreviation in genealogy. Genealogy with abbreviation has three types as the following:

- (A) There is no individual's data to input.
- (B) Some names and/or generation numbers have to abbreviate.
- (C) Some relations are abbreviated temporarily after inputting data.

In the case (A), no abbreviation layout is necessary because of no individual's data. In the case (B), intermediate relations are skipped but abbreviation layouts are used because of ambiguous information. In the case (C), abbreviation layouts are used temporarily by user's requirement, and this case is the abbreviation in our research. Note that the cases (A) and (B) are lack of data.

#### 3.1 Abbreviation of only individuals' names

Figs. 12(a) and 13(a) show the samples of genealogy with abbreviation of only individuals' names. In these cases, three '○'s in 12(a) and four '□'s in 13(a) are used instead of individuals' names. These abbreviation layouts are the cases that unknown names are displayed by using only '○' or '□', and all of existing individuals are displayed. As a result, numbers of the individuals can be found.

To display these abbreviation layouts are very simple. If a switching function between names and symbols such as '○' or '□' on the individual's text-box is available, these abbreviation layouts can be displayed easily.

#### 3.2 Abbreviation both of generations and brothers and sisters

In the cases of Figs. 12(a) and 13(a), large displaying area is required according to increasing individuals, because all of the existing individuals are displayed. To cope with this difficulty, there is a case that abbreviation layouts of plural individuals are set to one. Figs. 12(b) and 13(b) show the samples of genealogy with abbreviation both of generations and brothers and sisters.

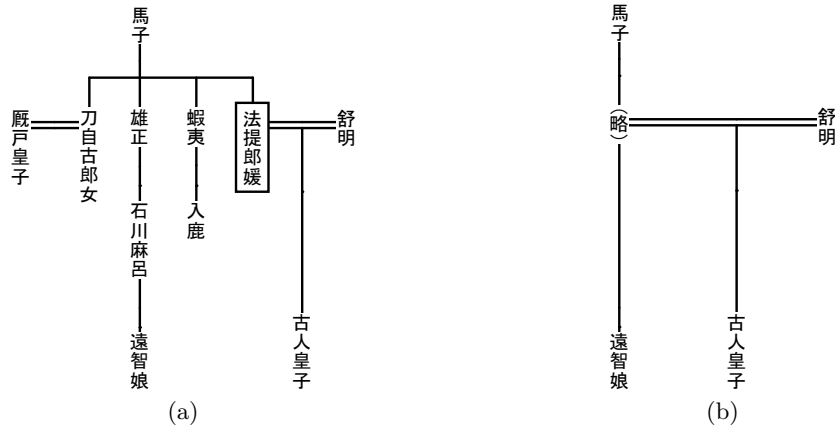

Fig. 14. Abbreviation of Marriages

Comparing Fig. 12(a) with Fig. 12(b), it can be found that three ‘○’s and one individual’s name are changed to a symbol ‘略’ by using the Japanese Kanji characters that means ‘(Abbreviation)’ or ‘(Skip)’. Similarly, comparing Fig. 13(a) with Fig. 13(b), it can also be found that four ‘□’s are changed to the same abbreviation symbol ‘略’. In these cases, the abbreviation symbols do not display the abbreviated numbers of individuals. As a result, the numbers both of generations, and brothers and sisters cannot be found. In contrast, the space of Figs. 12(b) and 13(b) is wider than Figs. 12(a) and 13(a).

To display these abbreviation layouts are not simple. If the switching function in 3.1 is used, displaying the abbreviation symbol can only be realized. However, two or more than three inputted individuals text-box can not be combined to abbreviate because this function can be used in only one individual.

### 3.3 Abbreviation of Marriages

Fig. 14(b) shows the abbreviation result in the case that the individual with a rectangle as shown in Fig. 14(a) is only abbreviated using the same symbol ‘略’. However, seven individuals that are her brothers and sisters and their children and a partner are also abbreviated to one symbol simultaneously. Because this layout around the abbreviated individual has a lot of horizontal relations and vertical relations. As a result, the space becomes wider, however, the number of abbreviated individuals cannot be found.

### 3.4 Problem of the abbreviated symbol

Figs. 15(a)–(c) show the abbreviated patterns for generations. (a), (b), and (c) denote abbreviation of one generation, two generations and three generations respectively. In these cases, all of layouts become the same style using the same abbreviation symbol. It is difficult to find the number of abbreviated generations.

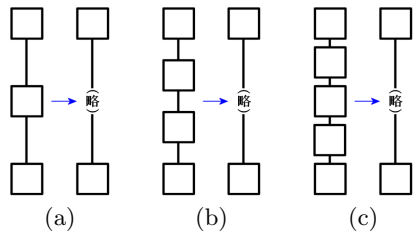

**Fig. 15.** Abbreviation of Generations

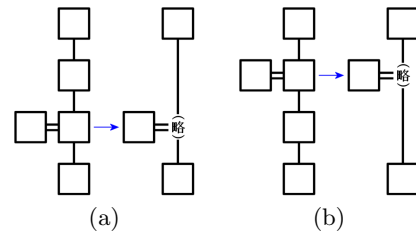

**Fig. 16.** Abbreviation of Marriages

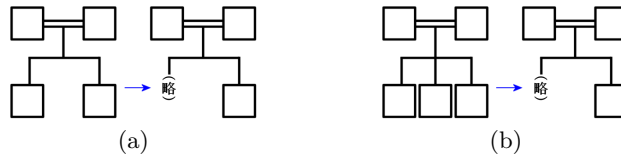

**Fig. 17.** Abbreviation of Brothers and Sisters

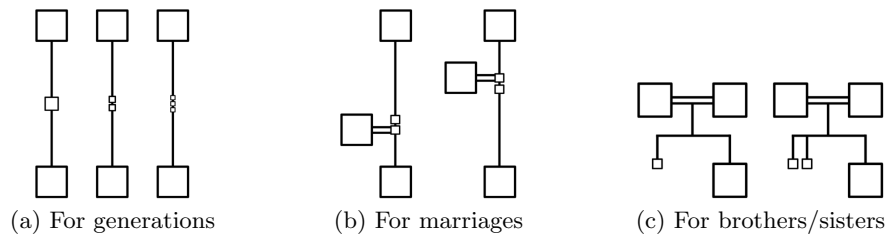

**Fig. 18.** Abbreviation Display using scale compaction

Figs. 16(a),(b) show the abbreviated patterns for marriages. (a) and (b) denote abbreviation of marriages in different generation. In these cases, two layouts also become the same style using the same abbreviation symbol. It is also difficult to find the connecting generation for marriages.

Figs. 17(a),(b) show the abbreviated patterns for brothers and sisters. (a) and (b) denote abbreviation of brothers and sisters in different numbers. In these cases, two layouts also become the same style using the same abbreviated symbol. It is also difficult to find the numbers of brothers and sisters.

If paper media is used, these problems do not occur. On the other hand, if genealogy display software is used, it has to avoid to input the same individual twice. It is necessary that abbreviated individuals can be found continually.

### 3.5 Displaying rule for abbreviation

Genealogy with abbreviation is very difficult because it has not only generations vertically but also marriages and/or brothers and sisters horizontally. To cope with the difficulty, a scale compaction method is proposed to display individuals and segments. The target to abbreviate the individuals' sizes and positions is only compacted. Figs. 18(a)-(c) show the displaying rule for abbreviation.



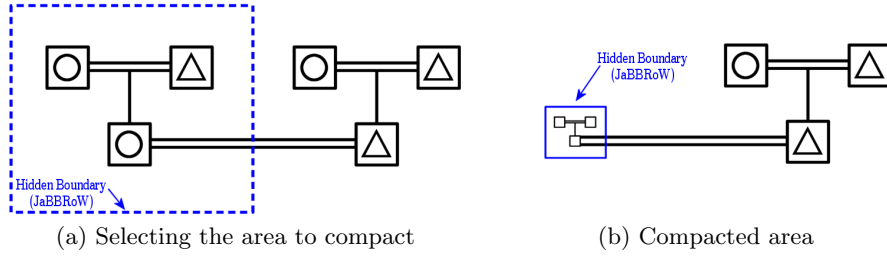

**Fig. 19.** Compacted and Recovered Operation by using the Hidden Node, JaBBRoW

As a result, not only these layout styles look like almost abbreviation display but also information of relations can always be found. In addition, all texts of abbreviated individuals should be non-display because it is not necessary to display texts while abbreviating. The size of compaction should be set freely by user’s requirements.

## 4 JaBBRoW

### 4.1 Hidden Boundary

This is a new data management method for adding the abbreviation method to the WHItEBasE model. A selected area of genealogy with abbreviation is managed as an event by a Hidden Boundary as shown in Fig. 19(a). The Hidden Boundary can be displayed on the genealogy display area, and it can also be non-displayed as user’s requirements. An arbitrary shape for the Hidden boundary is allowed, but a dotted rectangle is used in this research for convenience of mouse operations, and when the area is compacted, the rectangle becomes solid line as shown in Fig. 19(b).

This Hidden Boundary is not the normal selecting area in mouse operation. Once the Hidden Boundary is set, it can be kept until deleting it. As a result, the compacted and recovered operation can always be performed. In addition, all of relations in genealogy can be maintained while compacting, and all of relations in the Hidden Boundary can be scale down to the very small area. The model using the hidden boundary is named “Joint ABBReviatioN for Organizing WHItEBasE (JaBBRoW)”.

### 4.2 Coordinate System in JaBBRoW

Positions of each node managed by one WHItEBasE is measured from the origin in the displaying area using the absolute coordinate system  $\sum_{world}$  as shown in Fig. 8. On the other hand, the JaBBRoW is represented by using the moving coordinate system  $\sum_j$  different from  $\sum_{world}$ . They have different scales. The scale of  $\sum_j$  can be changed to increase/decrease according to the mouse wheel count by mouse operation on the inside of JaBBRoW rectangle. This means

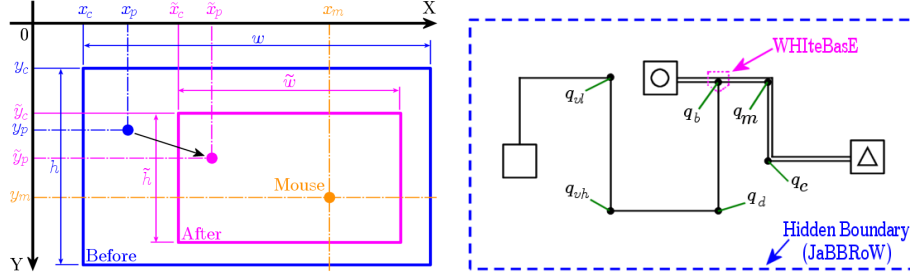

**Fig. 20.** Coordinate system in JaBBRoW **Fig. 21.** Managed nodes by JaBBRoW

that if the mouse position is on the outside of JaBBRoW rectangle, the scale of all genealogy area is changed.  $\sum_{\tilde{J}}$  is defined as the moving coordinate system after scale changing by one count of mouse wheel. This scale changing is set that the increasing rate is  $\frac{1}{0.9}$ , and the decreasing rate is 0.9 in this research. The compaction using JaBBRoW is defined as the coordinate transformation from  $\sum_J$  to  $\sum_{\tilde{J}}$  of each node in the JaBBRoW.

Fig. 20 shows the coordinate system in JaBBRoW where XY-coordinate system from the left-top origin denotes  $\sum_{world}$ , the rectangle ‘Before’ denotes  $\sum_J$ , the rectangle ‘After’ denotes  $\sum_{\tilde{J}}$ . The left-top position on ‘Before’ is  $(x_c, y_c)$ , its width and height are  $w, h$  respectively, the mouse point is  $(x_m, y_m)$ . If the left-top position on ‘After’  $(\tilde{x}_c, \tilde{y}_c)$  is represented by

$$\tilde{x}_c = x_m - (x_m - x_c) \frac{\tilde{w}}{w}, \quad \tilde{y}_c = y_m - (y_m - y_c) \frac{\tilde{h}}{h}, \quad (3)$$

the JaBBRoW rectangle can be scaled as center on the mouse position, where  $\tilde{w}, \tilde{h}$  denote the width and height of ‘After’ rectangle. In addition, an arbitrary point inside the rectangle ‘Before’ is  $(x_p, y_p)$ . If the position of the rectangle ‘After’  $(\tilde{x}_p, \tilde{y}_p)$  is represented by

$$\tilde{x}_p = \tilde{x}_c + (x_p - x_c) \frac{\tilde{w}}{w}, \quad \tilde{y}_p = \tilde{y}_c + (y_p - y_c) \frac{\tilde{h}}{h}, \quad (4)$$

the JaBBRoW rectangle can be scaled in maintaining all of the position relations of each node inside the rectangle. As a result, each node on the JaBBRoW is compacted to the mouse point when compacting, and each node keeps away when recovering. Finally, the position’s values of each node can be updated to the next position data in  $\sum_{world}$  and the previous WHItEBasE calculation method can be used without changing.

### 4.3 Definition of JaBBRoW Model

The information to manage in the JaBBRoW is a set of coordinate values of each node inside the JaBBRoW. Because the range of JaBBRoW rectangle is

set arbitrarily, there is a case that a WHItEBasE is included in the JaBBRoW, and, there is no case. Basically, if the WHItEBasE position  $q_b$  is not included in the JaBBRoW, the  $q_b$  is not managed by the JaBBRoW. In contrast, if the  $q_b$  is included, the coordinate values  $\mathbf{Q}$  managed by the WHItEBasE is searched whether all of  $\mathbf{Q}$  is included in the JaBBRoW or not. As a result, computational time can be reduced.

JaBBRoW is defined using a set of hyper-graph  $G$  represented by

$$G = ( V, \epsilon ) \quad (5)$$

where  $\epsilon$  denotes a hyper-edge given by

$$\epsilon = \{ J_0, J_1, J_2, \dots \in V \mid J_i \cap J_j = \emptyset, i \neq j \} \quad (6)$$

where  $J_k$  ( $k = 0, 1, 2, \dots$ ) denote a Hidden Boundary JaBBRoW, each JaBBRoW is a disjoint set, and one node is not managed by plural JaBBRoW. On the other hand,  $V$  denotes a set of each node inside the JaBBRoW represented by

$$V = \{ V_0, V_1 \} \quad (7)$$

where  $V_0$  and  $V_1$  denote a set of Individuals and a set of WHItEBasE respectively represented by

$$V_0 = \{ I_0, I_1, I_2, \dots, \mid I_j \notin J_k \text{ then } I_j \notin V_0, k = 0, 1, 2, \dots \} \quad (8)$$

$$V_1 = \{ W_0, W_1, W_2, \dots, \mid W_i \notin J_k \text{ then } W_i \notin V_1, k = 0, 1, 2, \dots \} \quad (9)$$

where  $I_j$  are coordinate values on the  $\sum_{world}$ , and  $W_i$  are coordinate values of only corner points in the WHItEBasE as shown in Fig. 21 represented by

$$W_i = \{ q_b, q_d, q_{vl}, q_{vh}, q_m, q_e \mid q_b \notin J_k \text{ then } q_d, q_{vl}, q_{vh}, q_m, q_e \notin W_i, k = 0, 1, 2, \dots \}. \quad (10)$$

As a result, a set of each node inside the JaBBRoW is scaled in each  $J_k$ . Note that  $q_{vl}, q_{vh}, q_m, q_e$  are not calculated when various layouts are not used.

#### 4.4 Registration Procedure to the JaBBRoW

Each node to manage by the JaBBRoW can be given by the following:

1. Add a new JaBBRoW rectangle from the menu of the WHItEBasE software.
2. Select the area to abbreviate by changing the size and position of JaBBRoW.
3. Spin the mouse wheel once to compact on the JaBBRoW rectangle.
4. Register all nodes inside the JaBBRoW rectangle.
5. Change the scale to all registered nodes for compaction.
6. Register the JaBBRoW ID to the all registered nodes.
7. All registered nodes are maintained until the JaBBRoW is recovered. As a result, to register a node twice can be avoided.

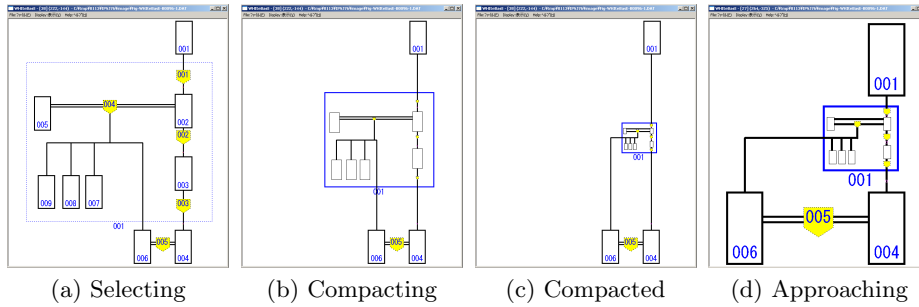

Fig. 22. Sample of Genealogy with Abbreviation using JaBBRoW

## 5 Demonstration of Our New Software

The JaBBRoW function is constructed on our previous WHItEBasE software. Fig. 22(a) shows the initial condition of JaBBRoW. Select the individuals and segments to abbreviate. Fig. 22(b) shows the intermediate condition by compacting of JaBBRoW. All registered nodes can be scale down and text is non-displayed. Fig. 22(c) shows the complete condition to compact. Even if the JaBBRoW is compacted, all individuals and segments can be seen, can be moved, and can be added/deleted such as previous WHItEBasE software. Fig. 22(d) shows some individuals are approached and genealogy scale is changed to large. In addition, even if JaBBRoW is used, the result of our previous research such as segment intersections and various layouts can be used as user's requirements.

## 6 Conclusion

In this research, a new method, "Joint ABBReviAtion for Organizing WHItEBasE (JaBBRoW)" have been proposed. Genealogy with Abbreviation could be constructed by using the JaBBRoW on our previous WHItEBasE method.

Using the JaBBRoW, an arbitrary area in genealogy can be compacted and recovered seamlessly by only mouse operations maintaining horizontal and vertical connections. It is possible to display a lot of genealogy information in a narrow displaying area because some relations can be abbreviated temporarily after inputting data. Understanding a whole genealogy with both a bird's-eye view in its totality and a detailed view can be easy. This method can give us the legibility of genealogy. Moreover, this idea is applicable also to another displaying matter that relations information has horizontal and vertical connections.

Future research will be conducted to construct automated layouts, generation search, grid layouts, improving GUI, etc.

## Acknowledgement

This research has received the assistance of the "Shin Buddhist Comprehensive Research Institute, Otani University, JAPAN".

## References

1. Sugito, S.: Alliance. news letter of Oceania conference, vol. (86), pp. 10–37 (2006) (in Japanese)
2. The Generations Network: Genealogy, Family Trees and Family History Records on line, <http://ancestry.com>
3. MyHeritage, <http://myheritage.jp>
4. Jurek Software, <http://www.pedigree-draw.com/>
5. He, M., Li, W.: PediDraw: A web-based tool for drawing a pedigree in genetic counseling. In: BMC Medical Genetics, pp. 1–4 (2007)
6. Brun-samarq, L., et al.: CoPE: a collaborative pedigree drawing environment. Bioinformatics ‘Applications Note’, 15(4), pp. 345–346 (1999)
7. Dudbridge, F., et al.: Pelican: pedigree editor for linkage computer analysis. Bioinformatics ‘Applications Note’, 20(14), pp. 2327–2328 (2004)
8. Trager, E.H., et al.: Madeline 2.0 PDE: a new program for local and web-based pedigree drawing. Bioinformatics ‘Applications Note’, 23(14), pp. 1854–1856 (2007)
9. Makinen, V.P., et al.: High-throughput pedigree drawing. European Journal of Human Genetics 13, pp. 987–989 (2005)
10. Mancosu, G., Ledda, G., Melis, P.M.: PedNavigator: a pedigree drawing servlet for large and inbred populations. Bioinformatics ‘Applications Note’, 19(5), pp. 669–670 (2003)
11. Tores, F., Barillot, E.: The art of pedigree drawing: algorithmic aspects. Bioinformatics, 17(2), pp. 174–179 (2001)
12. Loh, A.M., et al.: Celestial3D: a novel method for 3D visualization of familial data. Bioinformatics ‘Applications Note’, 24(9), pp. 1210–1211 (2008)
13. Aida, M.: Construction of a Japanese classic genealogy database. IPSJ SIG Computers and the Humanities, 2001-CH-051-6, pp. 39–46 (2001) (in Japanese)
14. Bennett, R.L., et al.: Recommendations for Standardized Human Pedigree Nomenclature. Journal of Genetic Counseling, 4(4), pp. 267–279 (1995)
15. PED Pedigree Software, <http://www.medgen.de/ped/>
16. PAF, <http://www.familysearch.org/>
17. ScionPC, <http://homepages.paradise.net.nz/scionpc/>
18. XY Family Tree, <http://www.xy-family-tree.com/>
19. WeRelate, [http://www.werelate.org/wiki/Main\\_Page/](http://www.werelate.org/wiki/Main_Page/)
20. GenoPro, <http://www.genopro.com/>
21. Naito, M.: Topic Map for Displaying Genealogy. SIG-SWO-A603-04, pp. 1–7 (2007) (In Japanese)
22. GEDCOM LETTER, <http://en.wikipedia.org/wiki/GEDCOM>
23. Sugiyama, S., Ikuta, A., Shibata, M., Matsuura, T.: A Study of An Event Oriented Data Management Method for Displaying Genealogy: Widespread Hands to InTErconnect BASic Elements (WHItEBasE). International Journal of Computer Information Systems and Industrial Management Applications (IJCISIM), pp. 280–289 (2011) ISSN: 2150-7988/2
24. Sugiyama, S., Ikuta, A., Yokozawa, D., Shibata, M., Matsuura, T. : Displaying Genealogy with Various Layouts by using the “WHItEBasE” Method, International Journal of Computer Information Systems and Industrial Management Applications (IJCISIM), pp. 102-115 (2014) ISSN: 2150-7988/6
25. Sugiyama, S., Ikuta, A., Yokozawa, D., Shibata, M., Matsuura, T.: Displaying Genealogy with Adoptions and Multiple Remarriages Using the WHItEBasE, Proc. of International Conference on Computer Information Systems and Industrial Management (CISIM), LNCS 8104, pp. 325-336 (2013)
26. Nerva–Antonine dynasty, <http://en.wikipedia.org/wiki/Nerva>