



HAL
open science

Design and Evaluation of Topology-aware Scatter and AllGather Algorithms for Dragonfly Networks

Nathanaël Cherièrè, Matthieu Dorier

► **To cite this version:**

Nathanaël Cherièrè, Matthieu Dorier. Design and Evaluation of Topology-aware Scatter and AllGather Algorithms for Dragonfly Networks. Supercomputing 2016, Nov 2016, Salt Lake City, United States. , Supercomputing 2016. hal-01400271

HAL Id: hal-01400271

<https://inria.hal.science/hal-01400271>

Submitted on 21 Nov 2016

HAL is a multi-disciplinary open access archive for the deposit and dissemination of scientific research documents, whether they are published or not. The documents may come from teaching and research institutions in France or abroad, or from public or private research centers.

L'archive ouverte pluridisciplinaire **HAL**, est destinée au dépôt et à la diffusion de documents scientifiques de niveau recherche, publiés ou non, émanant des établissements d'enseignement et de recherche français ou étrangers, des laboratoires publics ou privés.

Design and Evaluation of Topology-aware Scatter and AllGather Algorithms for Dragonfly Networks

New efficient communication algorithms for Dragonfly

- Cost of traditional topologies too high at scale
- Dragonfly: a new topology
- Opportunity for new efficient communication algorithms

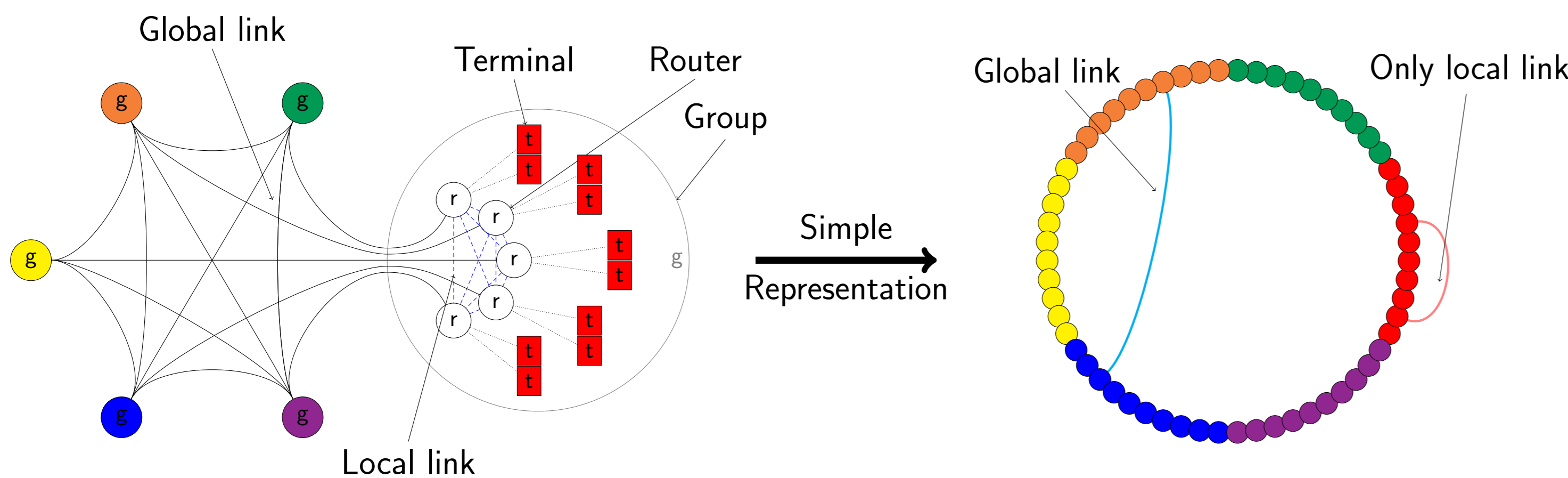

Challenge: Global links are potential bottlenecks

AllGather

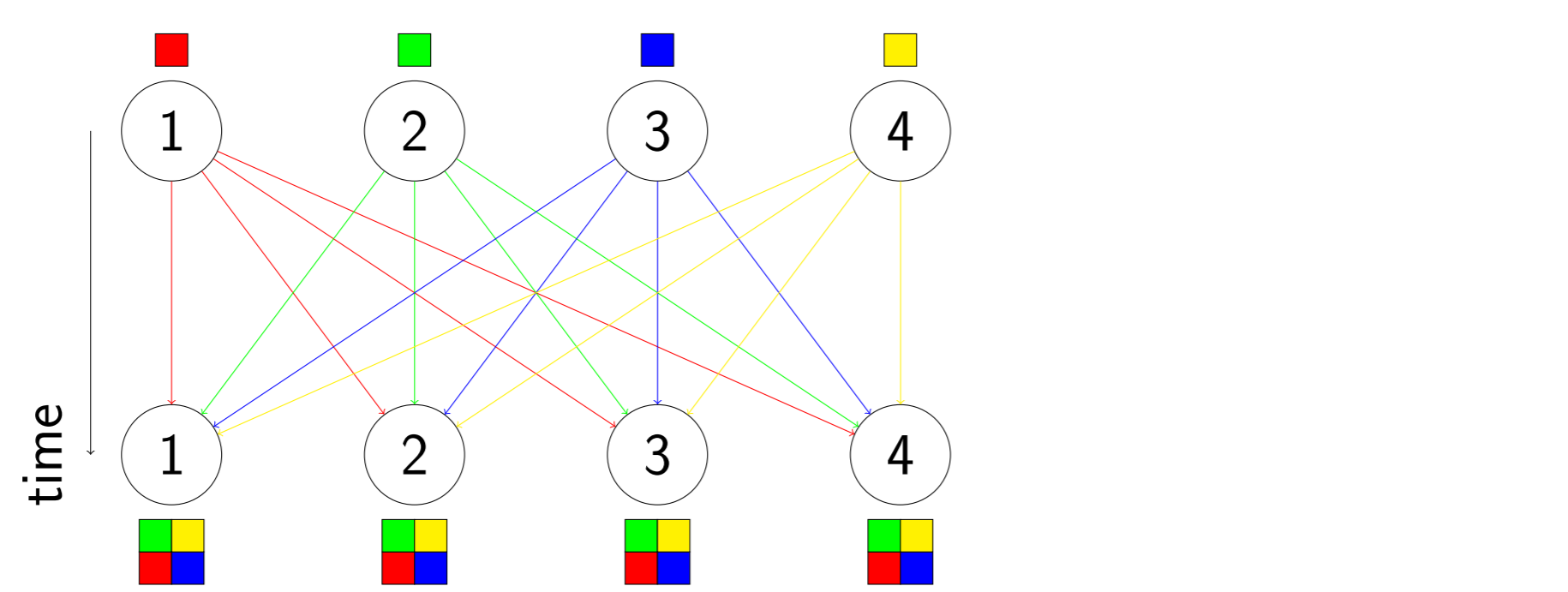

Existing algorithms

RING

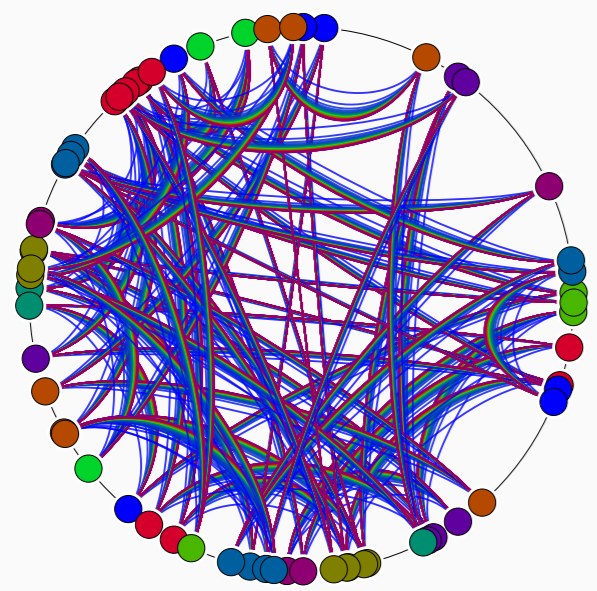

Default in MPICH for 80 KiB and more

BRUCK - Bruck's algorithm

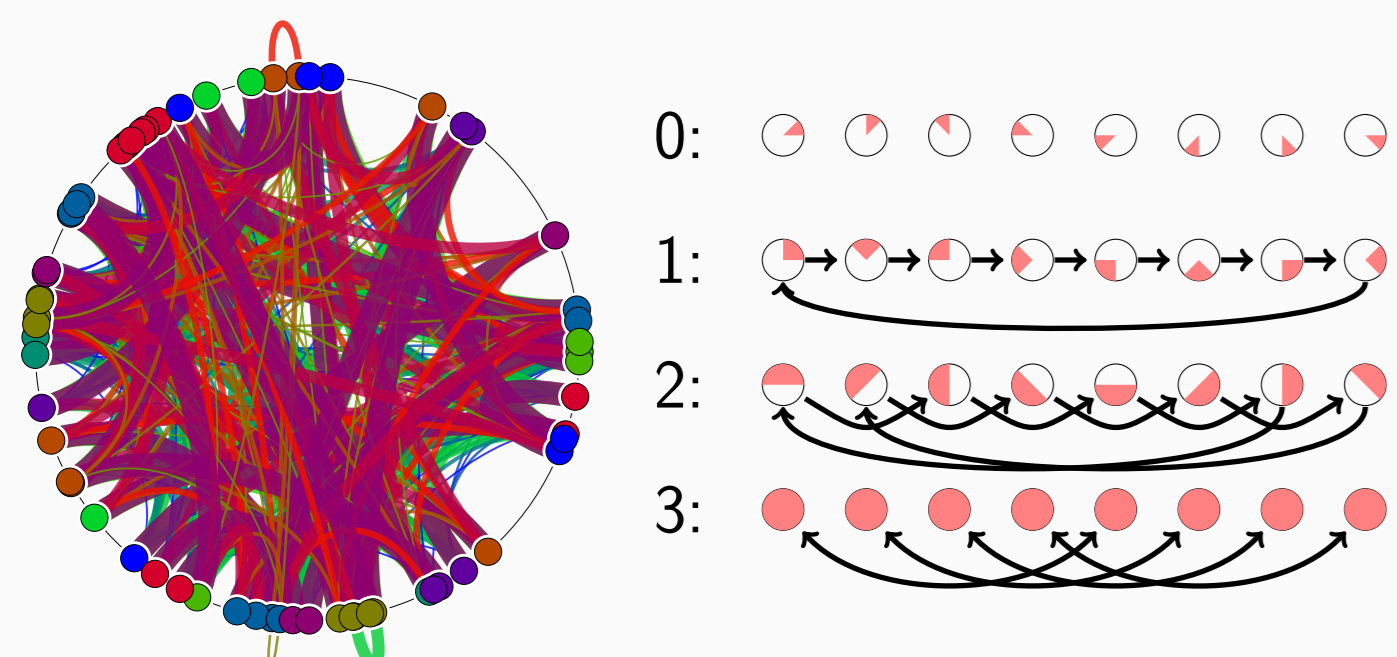

Default in MPICH for less than 80 KiB

Our contribution

TAR - Topology Aware Ring

Idea: minimize global link utilization

1. Build a smart ring
2. Send data

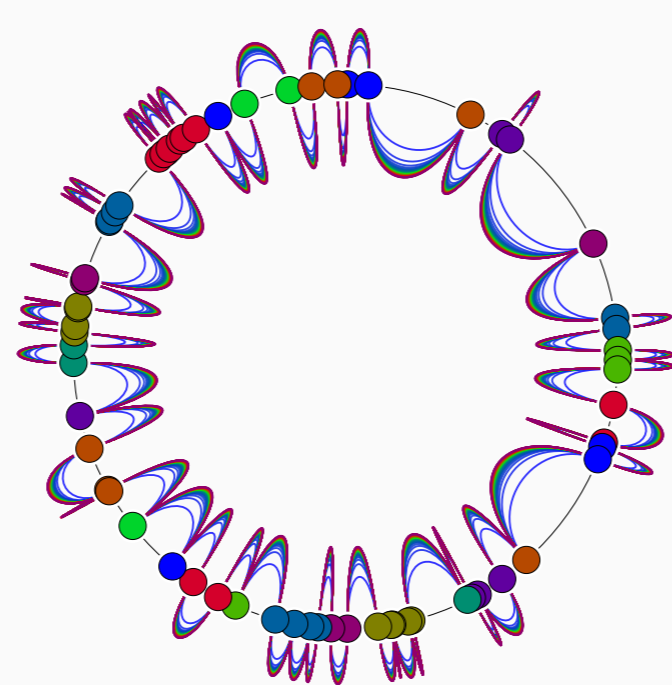

Minimize data transfers on global links

Evaluation

- CODES based on ROSS, an event driven simulator
- 5256 terminals: 73 groups, 12 routers per group, and 6 terminals per router
- Bandwidth:
 - * Global links at 4.7 GiB/s,
 - * Local links at 5.25 GiB/s,
 - * Terminal links at 5.25 GiB/s

1 KiB per terminal

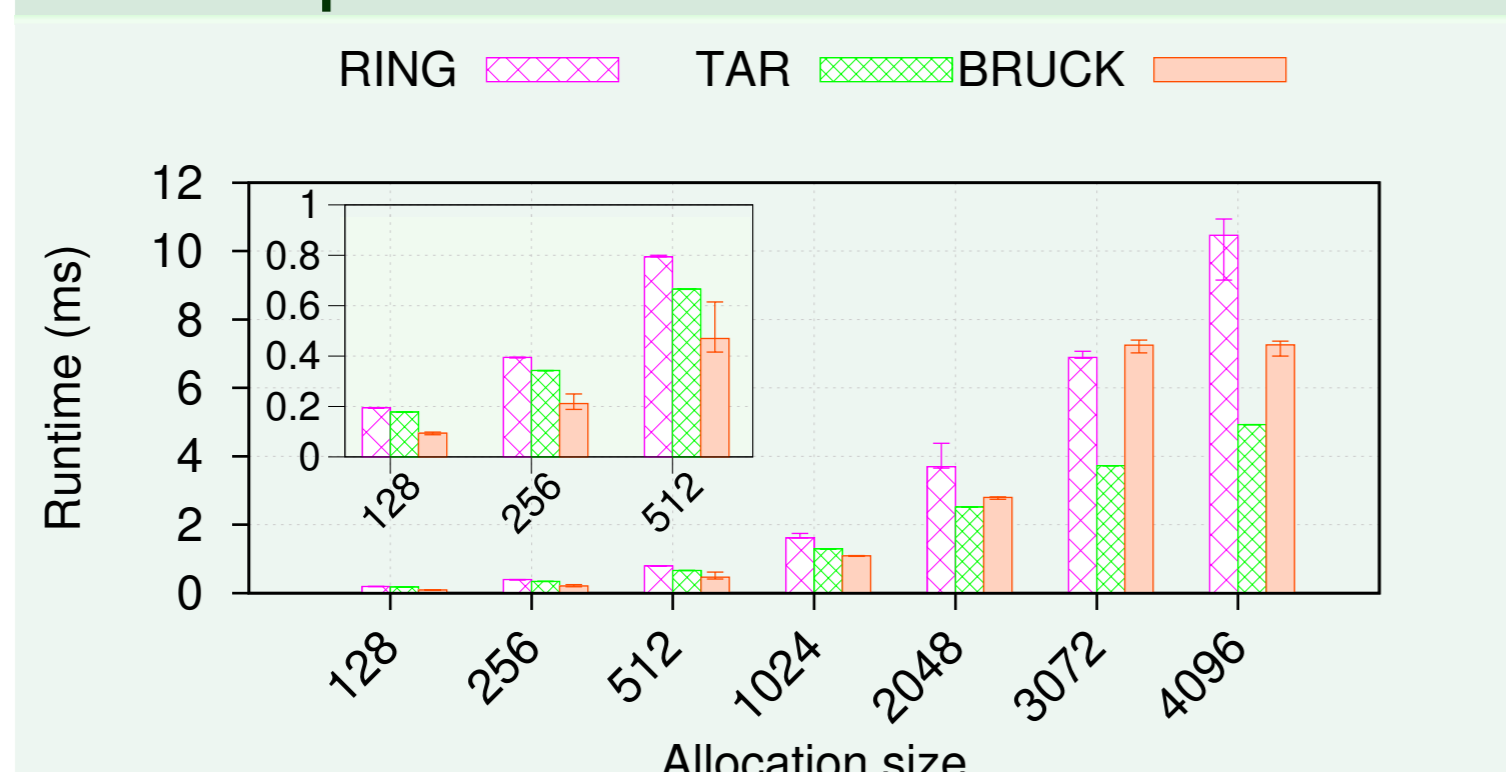

Conclusion

- Topology awareness matters: TAR wins!
- BRUCK still better for small transfers
- Background traffic does not change the behavior

Scatter

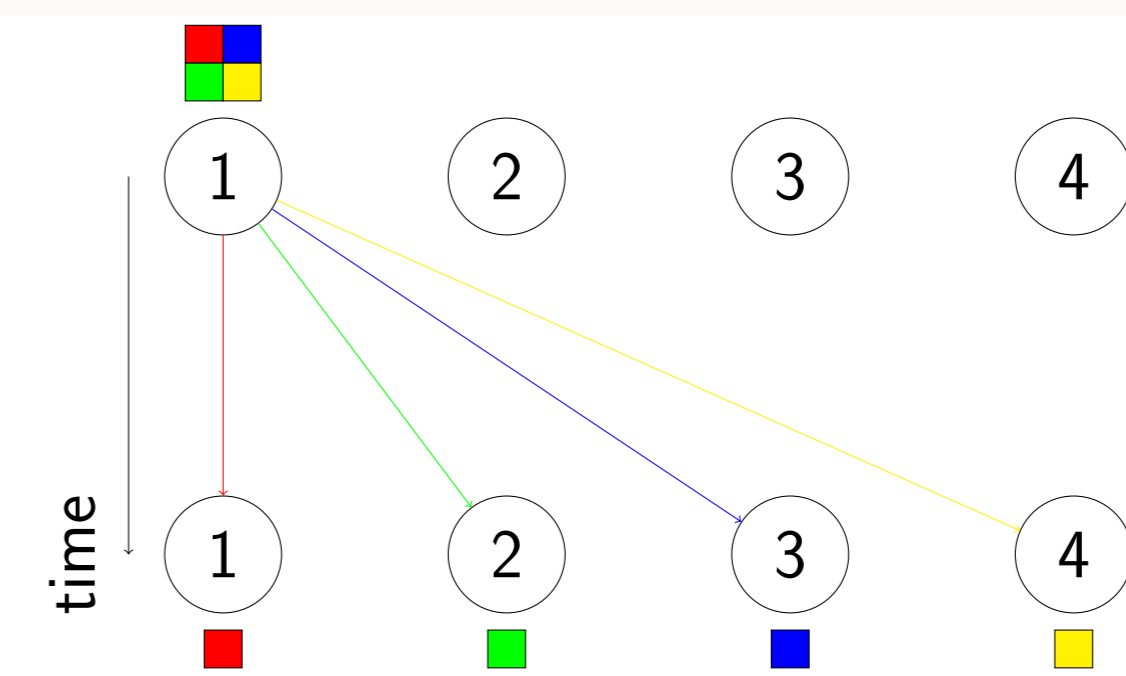

Existing Algorithms

TREE - Binomial Tree

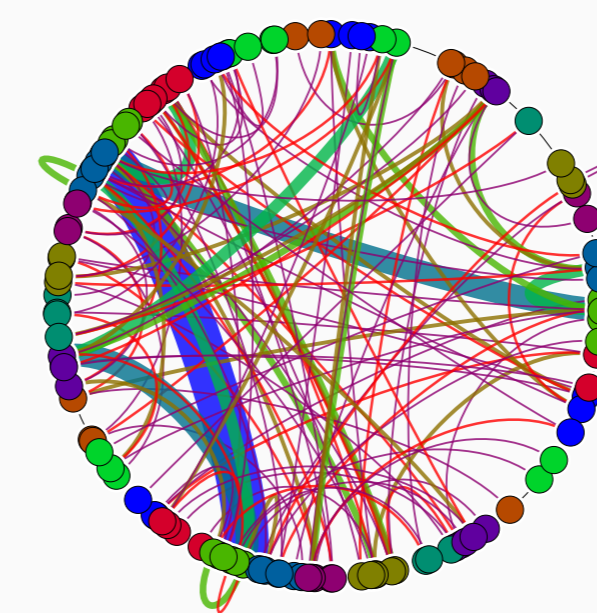

Default in MPICH

Simple approach

LIN

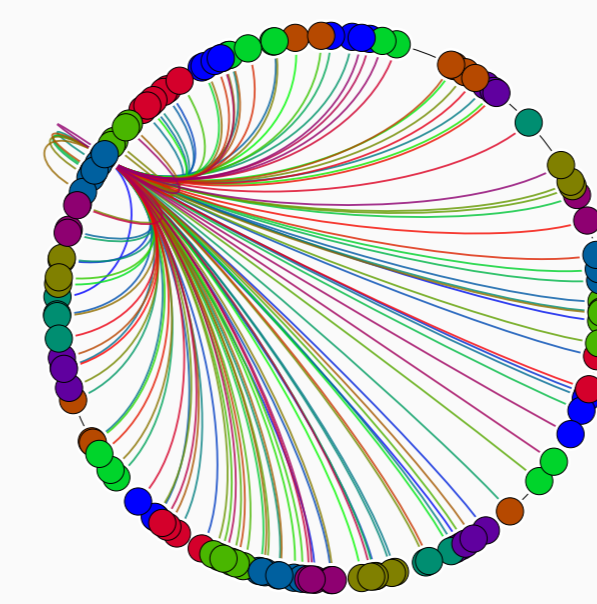

Send data to terminals one by one
 Minimize link utilization

Our contribution

GLF - Global Link First

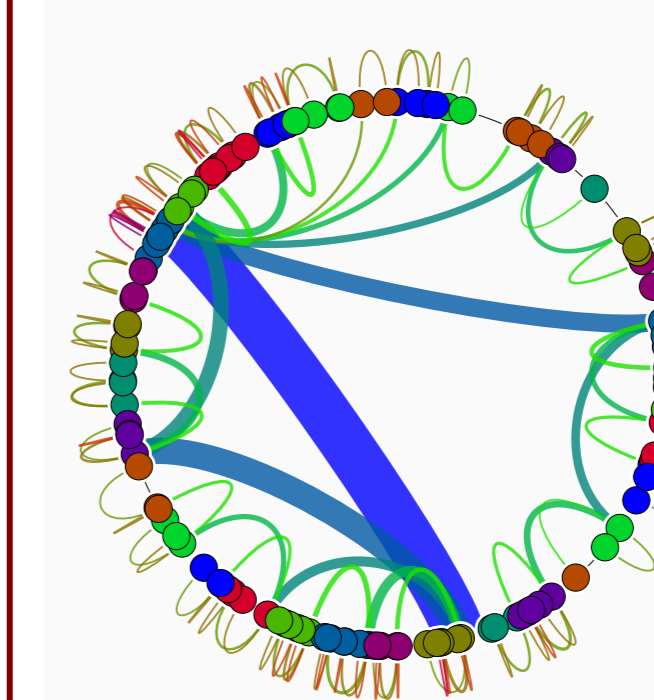

- Using TREE:
1. Send data to groups
 2. Send data to routers
 3. Send data to terminals

Use global links only during the first phase

LLF - Local Link First

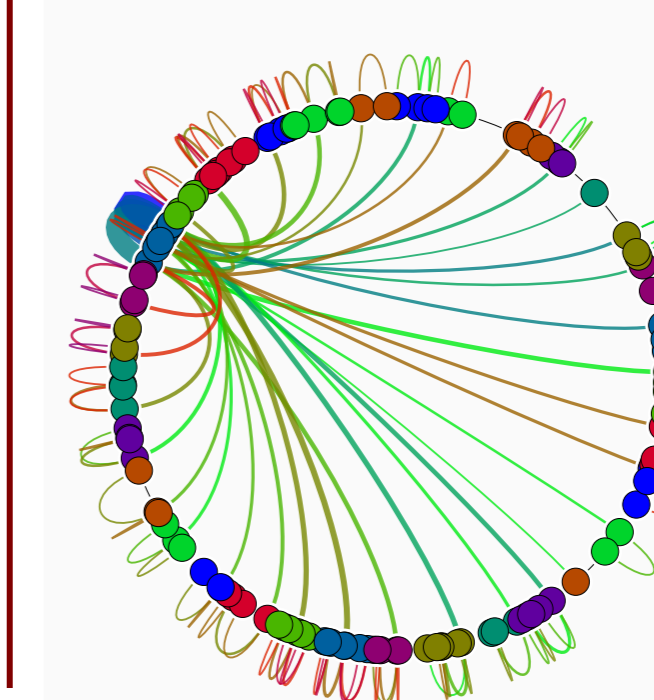

- Using TREE:
1. Send data to routers in root group
 2. Send data to groups
 3. Send data to routers
 4. Send data to terminals

Minimize data transfers on global links

LIN twice faster than the others!

Sending 1 KiB per terminal

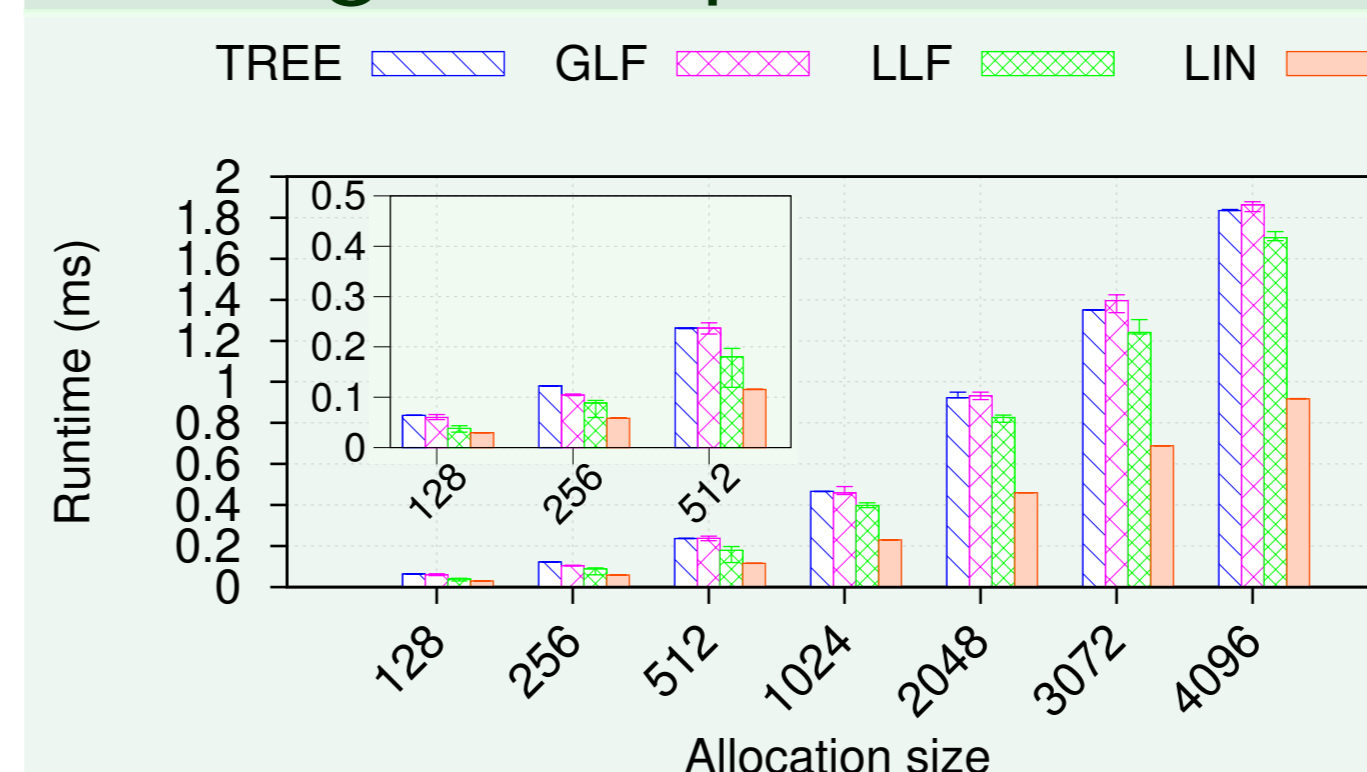

With uniform background traffic

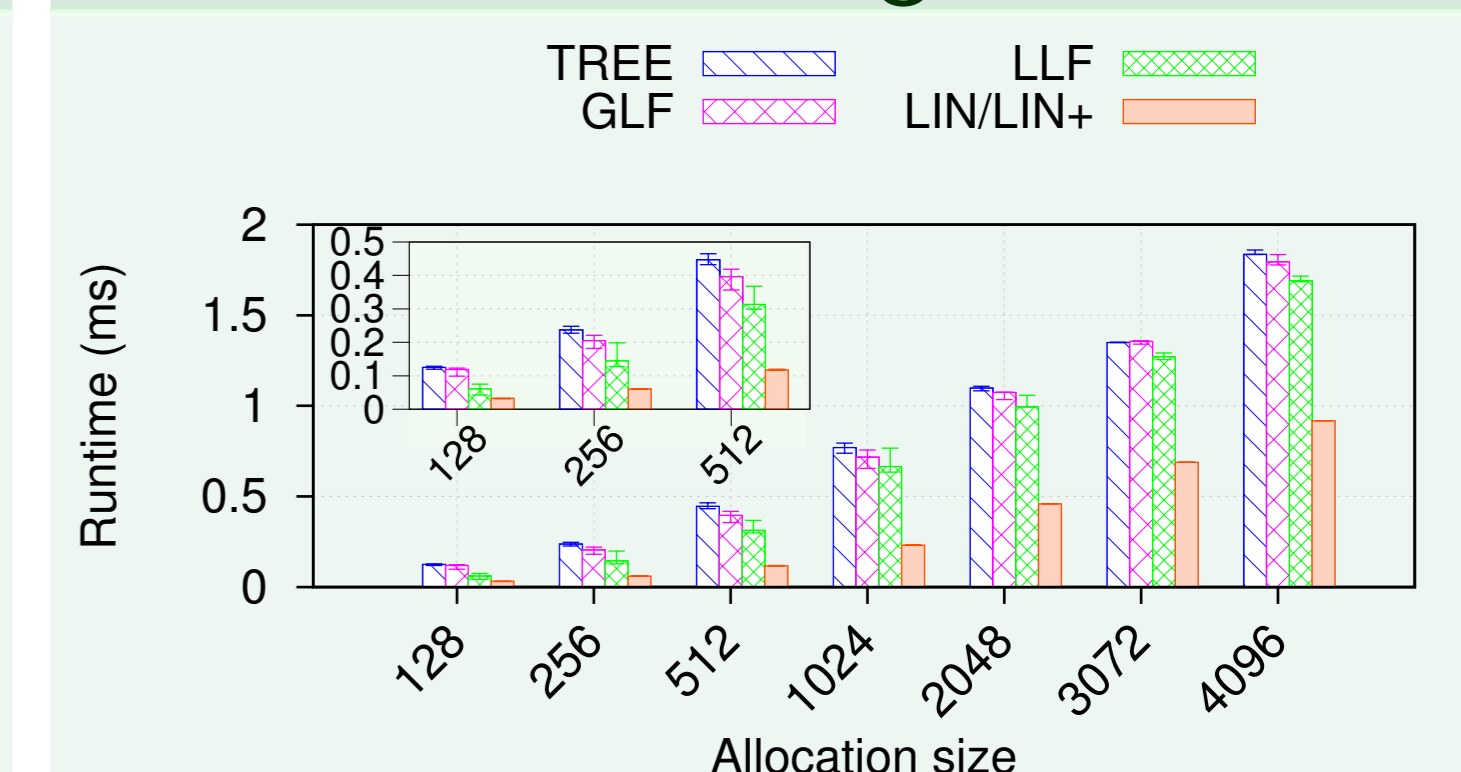

Major impact factor: the buffer size!

For TREE, GLF, and LLF:

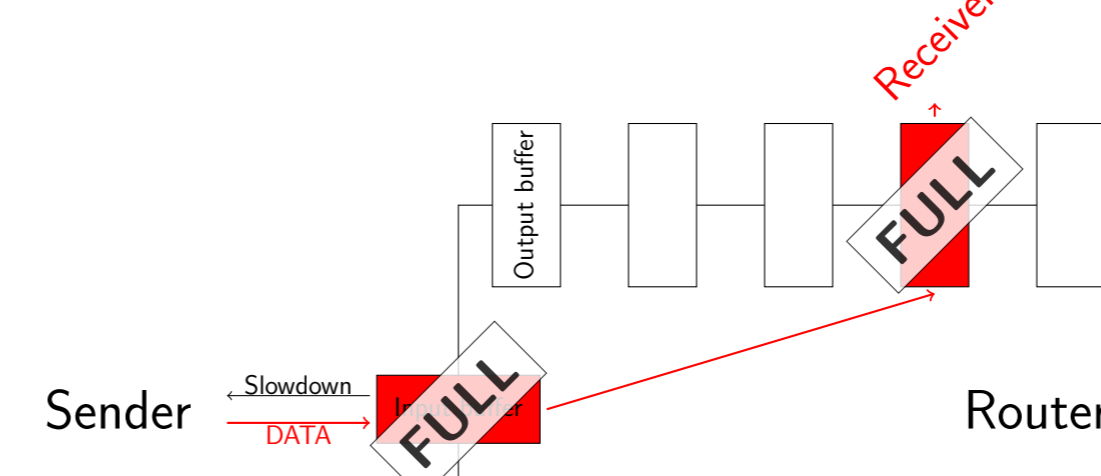

- Large amounts of data transferred
- Fills buffers, slows down transfer

For LIN:

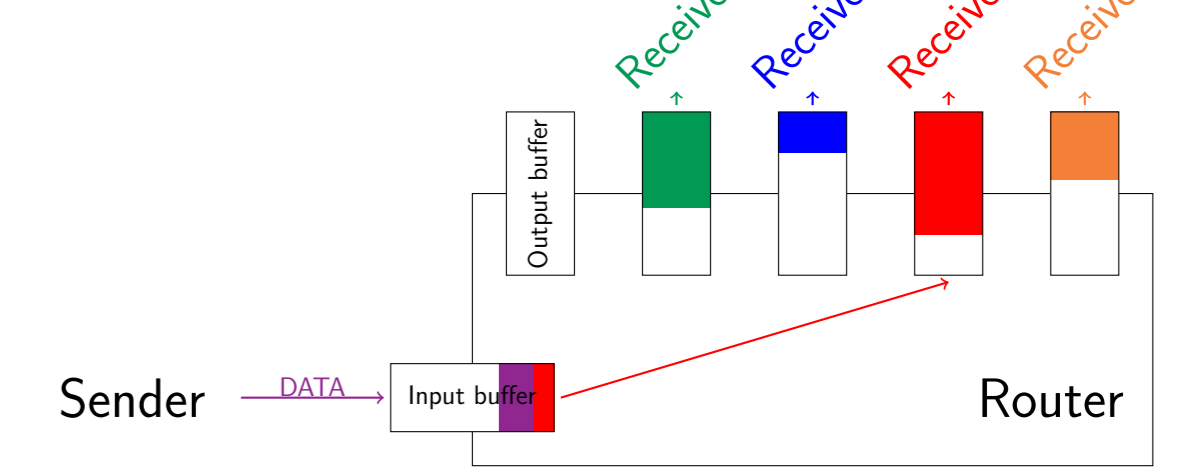

- 1 KiB transferred each time
- No buffer saturated, no slowdown

Conclusion

- Topology and hardware characteristics impact the performance of algorithms
- LIN is twice faster than LLF, GLF, and TREE
- No significant differences between LLF, GLF, and TREE

Discussion

Why is it complex to make AllGather hardware-aware?

- A lot more data sent over the network creating more contention
- Overall run time determined by the slowest link due to the ring structure
- Terminals transfer on the same path (TAR, RING), no balance across buffers

Ongoing work

- Broadcast as Scatter followed by AllGather
- Computation and communication algorithms such as Reduce
- Energy efficiency of communication algorithms