



**HAL**  
open science

# Formal Derivation of Qualitative Dynamical Models from Biochemical Networks

Wassim Abou-Jaoudé, Denis Thieffry, Jérôme Feret

► **To cite this version:**

Wassim Abou-Jaoudé, Denis Thieffry, Jérôme Feret. Formal Derivation of Qualitative Dynamical Models from Biochemical Networks. *BioSystems*, 2016, pp.100. 10.1016/j.biosystems.2016.09.001 . hal-01379733

**HAL Id: hal-01379733**

**<https://inria.hal.science/hal-01379733>**

Submitted on 17 Oct 2016

**HAL** is a multi-disciplinary open access archive for the deposit and dissemination of scientific research documents, whether they are published or not. The documents may come from teaching and research institutions in France or abroad, or from public or private research centers.

L'archive ouverte pluridisciplinaire **HAL**, est destinée au dépôt et à la diffusion de documents scientifiques de niveau recherche, publiés ou non, émanant des établissements d'enseignement et de recherche français ou étrangers, des laboratoires publics ou privés.

# Formal Derivation of Qualitative Dynamical Models from Biochemical Networks<sup>☆</sup>

Wassim Abou-Jaoudé<sup>a,b,\*</sup>, Denis Thieffry<sup>a</sup>, Jérôme Feret<sup>b,\*</sup>

<sup>a</sup>*Computational Systems Biology team, Institut de Biologie de l'École Normale Supérieure (IBENS), CNRS, Inserm, École Normale Supérieure, PSL Research University, F-75005 Paris, France*

<sup>b</sup>*DI-ENS (INRIA/ÉNS/CNRS/PSL\*), Paris, France*

---

## Abstract

As technological advances allow a better identification of cellular networks, large-scale molecular data are swiftly produced, allowing the construction of large and detailed molecular interaction maps. One approach to unravel the dynamical properties of such complex systems consists in deriving coarse-grained dynamical models from these maps, which would make the salient properties emerge. We present here a method to automatically derive such models, relying on the abstract interpretation framework to formally relate model behaviour at different levels of description. We illustrate our approach on two relevant case studies: the formation of a complex involving a protein adaptor, and a race between two competing biochemical reactions. States and traces of reaction networks are first abstracted by sampling the number of instances of chemical species within a finite set of intervals. We show that the qualitative models induced by this abstraction are too coarse to reproduce properties of interest. We then refine our approach by taking into account additional constraints, the mass invariants and the limiting resources for interval crossing, and by introducing information on the reaction kinetics. The resulting qualitative models are able to capture sophisticated properties of interest, such as a sequestration effect, which arise in the case studies and, more generally, participate in shaping the dynamics of cell signaling and regulatory networks. Our methodology offers new trade-offs between complexity and accuracy, and clarifies the implicit assumptions made in the process of qualitative modelling of biological networks.

---

## 1. Introduction

As technological advances allow a better identification of cellular networks, more and more molecular data are produced enabling the construction of de-

---

<sup>☆</sup>This material is based upon works sponsored by the “École normale supérieure” (ÉNS) under an incitative action and by the Defense Advanced Research Projects Agency (DARPA) and the U. S. Army Research Office under grant number W911NF-14-1-0367. The views, opinions, and/or findings contained in this article are those of the authors and should not be interpreted as representing the official views or policies, either expressed or implied, of the “École normale supérieure”, the Defense Advanced Research Projects Agency, or the U. S. Department of Defense.

\*Corresponding authors

tailed molecular interaction maps. These maps form large and complex intertwined biochemical networks, which dynamical functioning is very hard to decipher. One approach to unravel the dynamical properties of such systems relies on the derivation of qualitative dynamical models from these maps, in order to ease the analysis of their dynamics [1, 2].

In qualitative modelling, the quantity of a biochemical species is usually modeled by a qualitative discrete level representing a range of concentration (or activity) of the component (rather than the exact number or concentration). Logical rules then specify the evolution of each component level depending on the other ones. Such rules can be defined as logical functions (as it is done in logical modelling [3]), or they can directly encode sets of reactions denoting molecular consumption and production processes (as it is the case in the Boolean semantics of BIOCHAM [4]).

Automatic methods for model derivations still lack of convenient trade-off between efficiency and accuracy. Some abstractions consist only in partitioning the state space (as in the Boolean semantics of BIOCHAM [4]). These abstractions are usually too conservative and fail in detecting properties of interest. They have to be refined by integrating an approximated quantitative description of the dynamics of the model in each partition class, as done in tropical approximations [5] and piecewise affine systems [6]. Yet, the latter methods provide no explicit bounds for numerical errors (at best an asymptotic estimation of them).

Our motivation is twofold: not only we want to design an automatic tool to derive accurate coarse-grained discrete models from reaction networks, but also we want to better understand the process of qualitative modelling and its underlying implicit assumptions. To achieve these goals, we use abstract interpretation. Abstract interpretation has been introduced forty years ago as a mathematical framework to formally relate the behaviour of programs or models, seen at different levels of abstraction. Since then, abstract interpretation has been used not only to establish formal comparisons between abstraction techniques [7], but also to develop static analyzers that abstract automatically the behaviour of programs or models [8, 9]. Abstract interpreters are now spreading across the industrial community (for instance, companies as MicroSoft, Google, Facebook, and The Mathworks have been developing their own abstract interpreters).

The abstract interpretation framework is based on the idea that the behaviour of a program or a model can be described formally as the least fixpoint  $lfp \mathbb{F}$  of a monotonic operator  $\mathbb{F}$  over the elements of a so-called concrete domain  $\mathcal{D}$ , which is usually the set  $\wp(\mathcal{S})$  of the subsets of a given set  $\mathcal{S}$  of elements. Then, an abstraction is a change of granularity in the description of the behaviour of the programs and the models, that can be mathematically formalized by various means, such as upper closure operators, ideals, Moore families, and Galois connections. In this paper, we use Galois connections, because it is the most popular means to describe an abstract interpretation. A change of observation level can be described by introducing a domain  $\mathcal{D}^\sharp$  of properties of interest, that is ordered by a partial order  $\sqsubseteq$ . Each element  $a^\sharp$  of the abstract domain  $\mathcal{D}^\sharp$  is then related to the set of the concrete elements  $\gamma(a^\sharp) \in \mathcal{S}$  that satisfy this abstract property, the so-defined function  $\gamma$  being monotonic. An abstract element  $a^\sharp$  is called an abstraction of a given set  $a$  of concrete elements, if and only if,  $a \subseteq \gamma(a^\sharp)$ . A Galois connection is obtained when each subset  $a \subseteq \mathcal{S}$

has a most precise abstraction, that is to say that for any subset  $a \subseteq \mathcal{S}$ , there exists an abstract element  $\alpha(a)$  such that, for any other abstraction  $a^\#$  of the element  $a$ , we have  $\alpha(a) \sqsubseteq a^\#$ . In this case, the function  $\alpha \circ \mathbb{F} \circ \gamma$  is the best abstract counterpart to the function  $\mathbb{F}$ . Moreover, any monotonic function  $\mathbb{F}^\#$  over the abstract domain  $\mathcal{D}^\#$  such that  $[\alpha \circ \mathbb{F} \circ \gamma](a^\#) \sqsubseteq \mathbb{F}^\#(a^\#)$ , for each element  $a^\# \in \mathcal{D}^\#$ , satisfies  $\text{lfp } \mathbb{F} \subseteq \gamma(\text{lfp } \mathbb{F}^\#)$ , that is to say that the behaviour of the program or the model can be carried out in the abstract domain, and the result is a sound over-approximation. By soundness, we mean that we miss no concrete behaviour. Yet our result may be approximate when the inclusion is strict, meaning that, because of the over-approximation, our abstraction has introduced spurious behaviours.

Sound over-approximations should not be confused with numerical approximations. A numerically approximated computation provides a behaviour that is close (hopefully) to the behaviour of the concrete program or model. However even with asymptotic guarantees, without an explicit bound of the numerical error, it is not possible to bound the effective values of the variables in the initial exact model. In contrast, the abstract interpretation framework has been used to develop certified numerical integration engines, in order to provide a sound over-approximation of the values of the variables in hybrid systems, by the means of couples of functions respectively for the lower and upper bound of the effective value of the variables [10].

It is important to make the distinction between the properties that can be derived by the abstraction, and the underlying assumptions coming from the modelling paradigm. Indeed, the choice of the initial semantics is crucial, and it usually depends on the kind of modelling framework we are using. There is no ideal semantics. Even the concrete semantics is a trade-off between what we can or want to observe about the execution of programs or models. Especially, it is important to fix the assumptions that explain how to solve competitions between potential reactions at different rates. There are different propositions in the literature according to the community. In this paper, we focus on the underlying assumptions that have been used in logical modelling [13].

Our approach is the following. In Section 3, we formalise the behaviour of reaction networks by keeping the exact number of instances of chemical species. In Section 4, we propose an abstraction in which the number of instances is sampled within a finite set of intervals. In Section 5, we refine this abstraction by taking into account three kinds of properties: we deal with mass preservation invariants in Section 5.1; we detect when the number of instances of a given chemical species cannot cross its sampling intervals in Section 5.2; we enrich the description of the behaviour of the models with information about the reaction rates and take into account the separation between time-scales in Section 5.3. Finally we show the applications of our refined abstraction on our case studies in Section 6.

## 2. Case studies

Firstly, we consider a model with three kinds of proteins  $A$ ,  $B$  and  $C$ . We assume that the protein  $B$  is an adaptor between the proteins  $A$  and  $C$ , that is to say that each instance of  $B$  can bind to an instance of  $A$  and/or to an instance of  $C$ . We wonder what is the influence of the initial concentration of the protein  $B$  on the concentration of the trimer  $ABC$ . Intuitively, the more  $B$ s we put

in the model, the more  $ABC$ s will be formed. Yet this is not the case, since at high concentration, the protein  $B$  prevents the proteins  $A$  and  $C$  to meet since almost each instance of  $A$  (resp.  $C$ ) belongs to a dimer  $AB$  (resp.  $BC$ ), and thus there is no available  $A$ s (resp.  $C$ s) to form the trimers  $ABC$ . Thus, at high concentration, by sequestration effect, the adaptor prevents the formation of trimers  $ABC$ .

Figure 1 lists the reactions of the model (Fig. 1(a)), the system of equations (under the assumptions of the law of mass action) (Fig. 1(b)), and the concentration of the trimer  $ABC$  when the reactions have run to completion with respect to the initial concentration of the protein  $B$  (Fig. 1(c)). We notice that at low concentration of the protein  $B$ , the concentration of the trimer  $ABC$  grows linearly, whereas it drops following an homographic function at high concentration of the protein  $B$ . Interestingly, this sequestration effect has also been observed *in vivo* [11].

Secondly, we consider a model also involving three kinds of proteins  $A$ ,  $B$ , and  $C$ . We assume that the protein  $A$  can be turned into protein  $B$  or  $C$ . More precisely, we assume that the production of an instance of  $B$  requires only one instance of the protein  $A$ , whereas the production of an instance of  $C$  requires two instances of the protein  $A$ . Here we wonder what is the influence of the initial concentration of the protein  $A$  on the concentration of the proteins  $B$  and  $C$ . Intuitively, the more  $A$  we put in the model the more  $C$  will be produced from the binary reaction compared to the production of  $B$  from the unary reaction. Therefore, at high (resp. low) concentration of  $A$ , the binary (resp. unary) reaction preempts the unary (resp. binary) one.

Figure 2 lists the reactions of the model (Fig. 2(a)), the system of equations (under the assumptions of the law of mass action) (Fig. 2(b)), and the concentration of the ratio between the concentration of the proteins  $C$  and  $B$  when the reactions have run to completion with respect to the initial concentration of the protein  $A$  (Fig. 2(c)).

These examples are well suited for testing the accuracy of our approach, since two different dynamical behaviours may emerge according to the relative position of some expressions that depend on the initial concentrations of some proteins and on the rates of the reactions, with respect to some semi-quantitative thresholds: in the first example what matters is the quotient between the initial concentration of the protein  $B$  and the initial concentrations of the proteins  $A$  and  $C$ ; in the second example, the behaviour is driven by the quotient between the product of the reaction rate  $k'_2$  and the initial concentration of the protein  $A$ , and the reaction rate  $k'_1$ . There is no need to know precisely the rates of the reactions, nor the initial concentrations of proteins. These quantitative details shift the thresholds but have no impact on its existence (unless one of the reaction rate is set to 0).

Although we have shown these phenomena on the deterministic (differential) semantics, considering only forward reactions, they also occur with a stochastic semantics and/or reversible reactions. A fine description of these models should account for complex properties such as concurrency and sequestration phenomena (in the first case study, when an instance of the protein  $A$  is bound to an instance of the protein  $B$ , it is no longer available to bind with an instance of the dimer  $BC$ ), as well as for the race between competing reactions (in the second case study, if there are many instances of  $A$ , an instance of  $C$  is more likely to be produced than an instance of  $B$ ).

(a) Reactions.

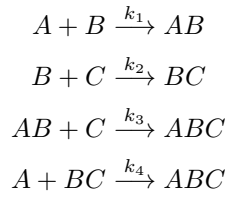

(b) Equations.

$$\left\{ \begin{aligned}
 \frac{d[A]}{dt} &= -[A](k_1[B] + k_4[BC]) \\
 \frac{d[B]}{dt} &= -[B](k_1[A] + k_2[C]) \\
 \frac{d[C]}{dt} &= -[C](k_2[B] + k_3[AB]) \\
 \frac{d[AB]}{dt} &= k_1[A][B] - k_3[AB][C] \\
 \frac{d[BC]}{dt} &= k_2[B][C] - k_4[A][BC] \\
 \frac{d[ABC]}{dt} &= k_3[AB][C] + k_4[A][BC]
 \end{aligned} \right.$$

(c) Concentration of  $ABC$  at system completion with respect to the initial concentration of  $B$ .

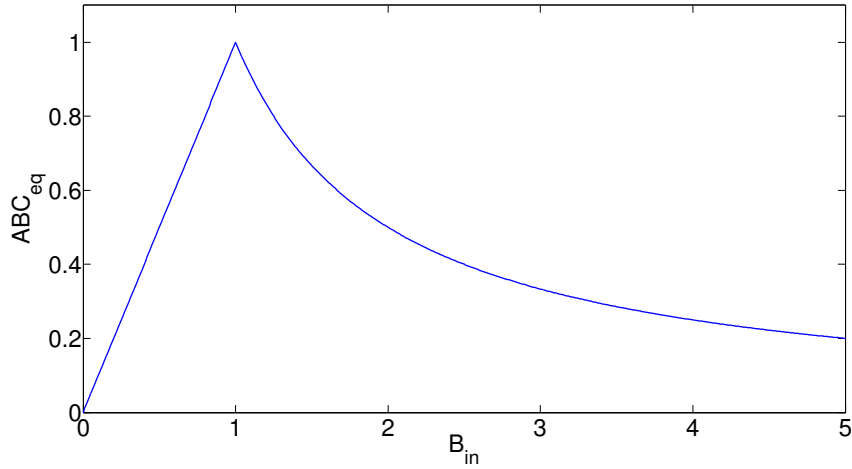
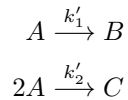

Figure 1: A model with an adaptor. We plot the concentration of the trimer  $ABC$  at system completion with respect to the initial concentration of the adaptor protein  $B$ , with all reaction rates equal to 1 and with an initial concentration of 1 for the proteins  $A$  and  $C$ , and of 0 for the complexes  $AB$ ,  $BC$ , and  $ABC$ . More details on the analytic solutions of this system are provided in Appendix C.

(a) Reactions.



(b) Equations.

$$\begin{cases} \frac{d[A]}{dt} = -k'_1[A] - 2k'_2[A]^2 \\ \frac{d[B]}{dt} = k'_1[A] \\ \frac{d[C]}{dt} = k'_2[A]^2 \end{cases}$$

(c) Ratio between the concentrations of  $C$  and  $B$  at system completion with respect to the initial concentration of  $A$ .

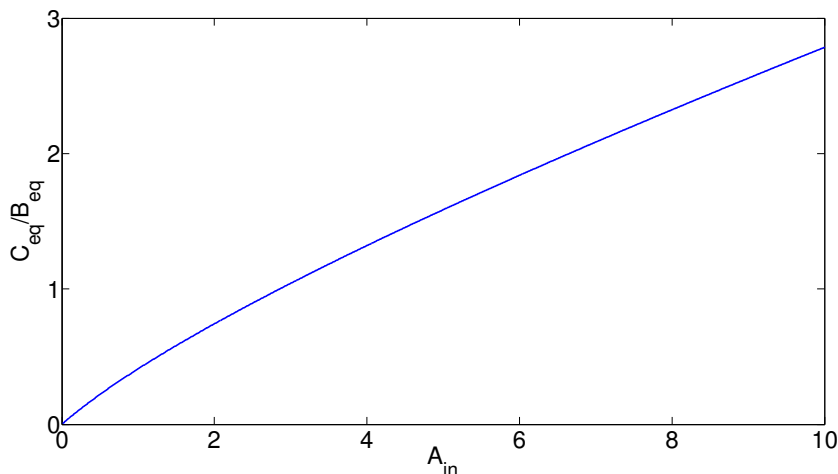

Figure 2: A model with a competition between a unary reaction and a binary reaction. We plot the ratio between the concentrations of the proteins  $C$  and  $B$  at system completion with respect to the initial concentration of the protein  $A$ , with all reaction rates equal to 1, and with an initial concentration of 0 for the proteins  $B$  and  $C$ . More details on the analytic solutions of this system are provided in Appendix C.

We now explain our approach and its application at a general level. The formalisation of our analysis as well as a detailed presentation of its application to the case studies will be described in the following sections. Before explaining our approach, we first need to sketch the behaviour of a reaction network. We start defining it qualitatively, without information on the kinetics of the reactions. More precisely, we model the behaviour of a reaction network by considering that each occurrence of a reaction consumes a given number of instances of its reactants and produces of a given number of instances of its products (the number of instances consumed and produced following the stoichiometry of the reaction). At this stage, we make no particular assumption about how reactions are selected: we remain in a non-deterministic qualitative framework.

Equipped with this semantics, a reaction network induces a transition system defined by its set of states (specifying the number of instances of each chemical species) and its set of transitions (defining the result of the application of the reactions). Figure 3 provides an illustration of the transition system of the reaction network of the model with adaptor, starting from a state composed of two instances of the chemical species  $A$  and  $C$ , one instance of the chemical species  $B$  and no instance of the other chemical species  $AB$ ,  $BC$  and  $ABC$ .

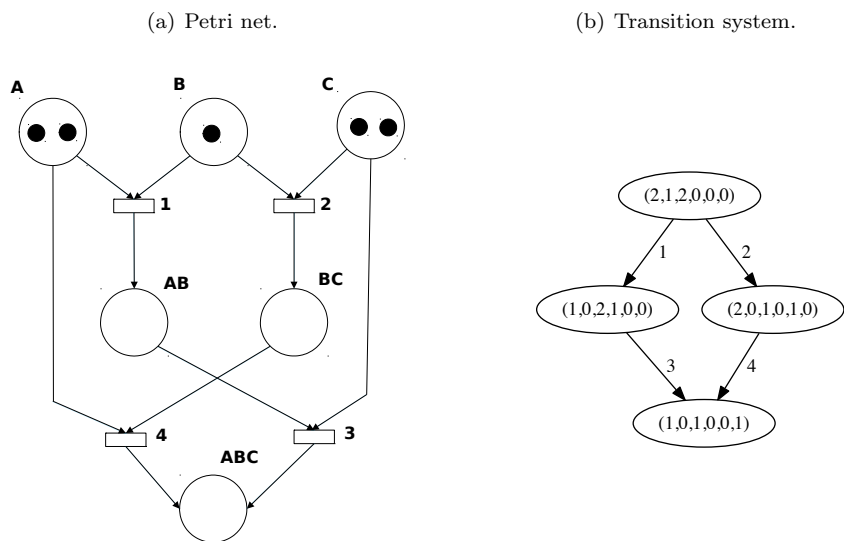

Figure 3: Illustration of the notion of transition system on the reaction network of the model with an adaptor. (a) Petri net representation of the reaction network in the initial state  $n_A = 2$ ,  $n_B = 1$ ,  $n_C = 2$ ,  $n_{AB} = 0$ ,  $n_{BC} = 0$  and  $n_{ABC} = 0$ , where  $n_A$ ,  $n_B$ ,  $n_C$ ,  $n_{AB}$ ,  $n_{BC}$  and  $n_{ABC}$  are the number of instances of the chemical species  $A$ ,  $B$ ,  $C$ ,  $AB$ ,  $BC$  and  $ABC$  respectively. Placeholders denote the chemical species while rectangular nodes represent the reactions. A token denotes an instance of the corresponding chemical species. (b) Induced transition system. A node represents a state while an arrow denotes a transition resulting from the application of the reaction labelling the arrow.

We notice that the induced transition system is equivalent to a Petri Net [12]. Each sequence of transitions defines what we call a trace of the system. The set of traces induced by a reaction network thus collects all the behaviours of the system starting from any initial state.

In this framework, each instance of a chemical species is taken into account. Actually qualitative models usually make the implicit assumption that the number of proteins is sampled in a finite number of intervals, one interval being represented by a discrete level of a model component of the qualitative model. Following this assumption we sample the number of instances of each chemical species within intervals to derive qualitative models capturing all the behaviours of the initial fine-grained one. Figure 4 provides an illustration of the principles of this coarse-graining step. Figure 5 shows a qualitative model for the case study with a race between a unary and a binary reaction starting from initial states where the level of  $A$  is high and the levels of  $B$  and  $C$  are very low. As the resulting qualitative models are too coarse to reproduce the properties of interest of our case studies, we consider three kinds of constraints in order to derive more accurate models.

The first kind of constraints that we consider is mass invariants. Mass invariants impose conservation laws on the number of instances of the chemical species. In the model with an adaptor, we see for example that the overall number of instances of  $A$ s, the overall number of instances of  $B$ s and the overall number of instances of  $C$ s remain constant (see Figure 3). Taking this constraint into account in our approach leads to the suppression of the states which are forbidden by this constraint, and thus to a more accurate qualitative model.



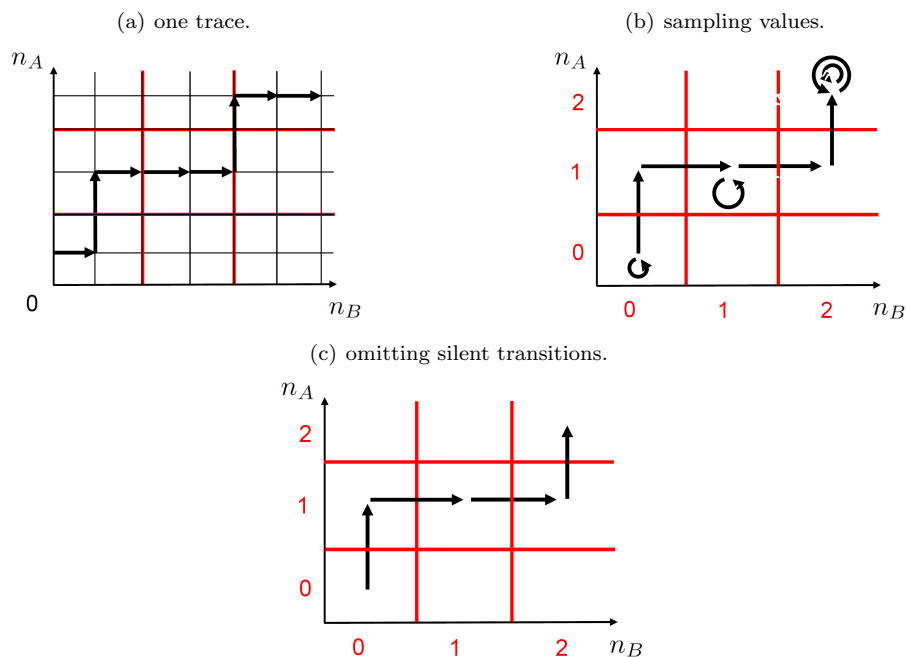

Figure 4: Sampling values and omitting silent transitions along traces. Fig. 4(a) shows an example of a trace considering 2 chemical species  $A$  and  $B$ . The number of instances of the chemical species (denoted by the black lines) are sampled in intervals (represented by the red lines) (Fig. 4(b)). The transitions for which the number of instances remains in the same sampling interval (represented by the self-loops) are further ignored (Fig. 4(c)). The reactions associated with the transitions are here omitted.

Figure 6 shows the behaviour of the qualitative model refined with a mass invariant for the case study with a race between a unary and a binary reaction, starting from the same initial states as in Figure 5.

The second kind of constraints that we consider consists in reasoning on the availability of resources in the system. Indeed when the number of instances of a chemical species enters a new sampling interval, there might not be enough resources in the system so that it may reach the next one. Figure 7 shows an example of such a situation for the case study of the model with an adaptor. Taking this kind of reasoning into account, we can suppress more unrealisable transitions, leading to a more accurate qualitative model. We show in Figure 8 the behaviour of the qualitative model after having discarded such unrealisable transitions from the model with a race between a unary and a binary reaction.

The third kind of constraints that we consider comes from the separation between time scales. Unlike mass invariants and limiting resources, such constraints do not emerge from the non deterministic semantics. Instead one has to refine the semantics in order to propose a way to model competitions between reactions. First of all, one has to associate a quantity (according to the modelling paradigm, this may be a flux, a rate, a propensity, a priority level) with each reaction. In general, this quantity depends on the current state of the system (so as to take into account the amount of available reactants). Then, several options can be chosen according to the kind of modelling paradigms and to the kind of models that we consider.

One option consists in interpreting the quantity that is associated with each

reaction as a priority level, and in bounding the number of occurrences of lower priority reactions with respect to the number of occurrences of higher priority reactions, in each sequence of consecutive transitions.

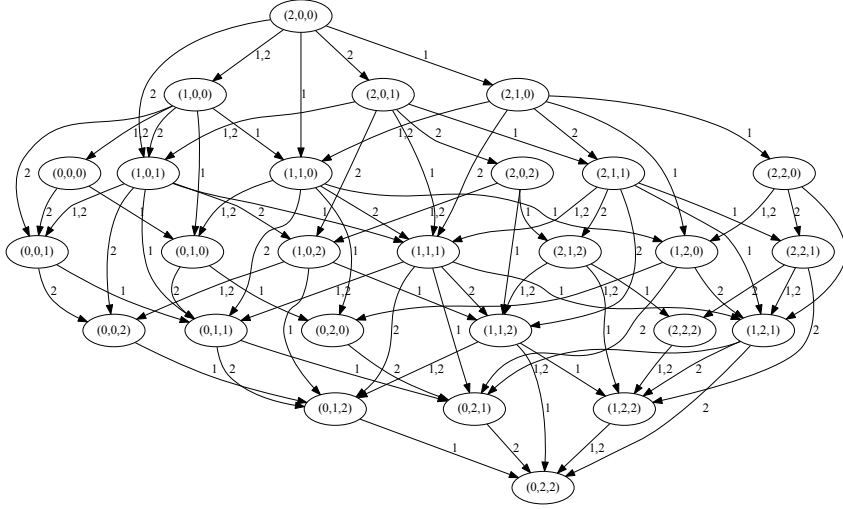

Figure 5: Behaviour of the qualitative model for the case study with a race between a unary and a binary reaction, starting from initial states with high levels of  $A$  and very low levels of  $B$  and  $C$  (node  $(n_A^\#, n_B^\#, n_C^\#)$ ). A node  $(n_A^\#, n_B^\#, n_C^\#)$  represents a qualitative state for which the level of  $A$ ,  $B$  and  $C$  is  $n_A^\#$ ,  $n_B^\#$  and  $n_C^\#$  respectively. Arrows denote transitions resulting from the application of the reactions labelling the arrow. Reaction 1 denotes the unary reaction while reaction 2 denotes the binary one.

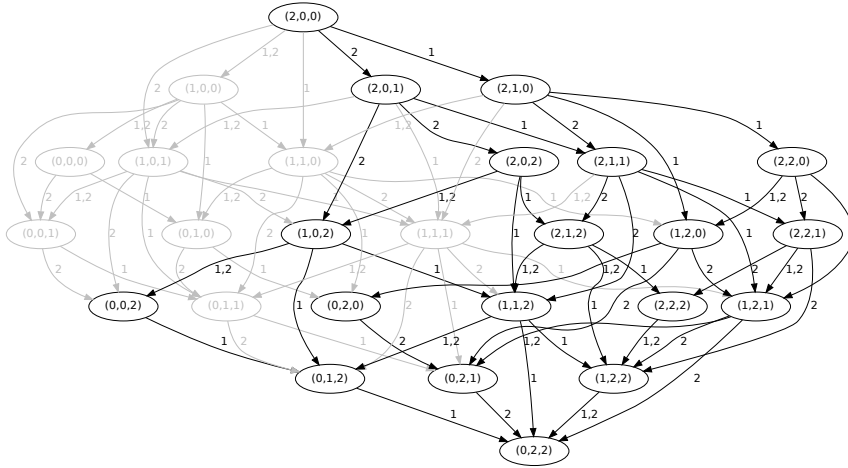

Figure 6: Behaviour of the qualitative model for the case study of the race between a unary and a binary reaction, refined with the mass invariant  $n_A + n_B + 2n_C = A_T$ , where  $n_A$ ,  $n_B$  and  $n_C$  denote the number of instances of  $A$ ,  $B$  and  $C$  respectively, and starting from initial states with high levels of  $A$  and very low levels of  $B$  and  $C$  (node  $(2, 0, 0)$ ). The states that are discarded by the refinement are depicted in grey.

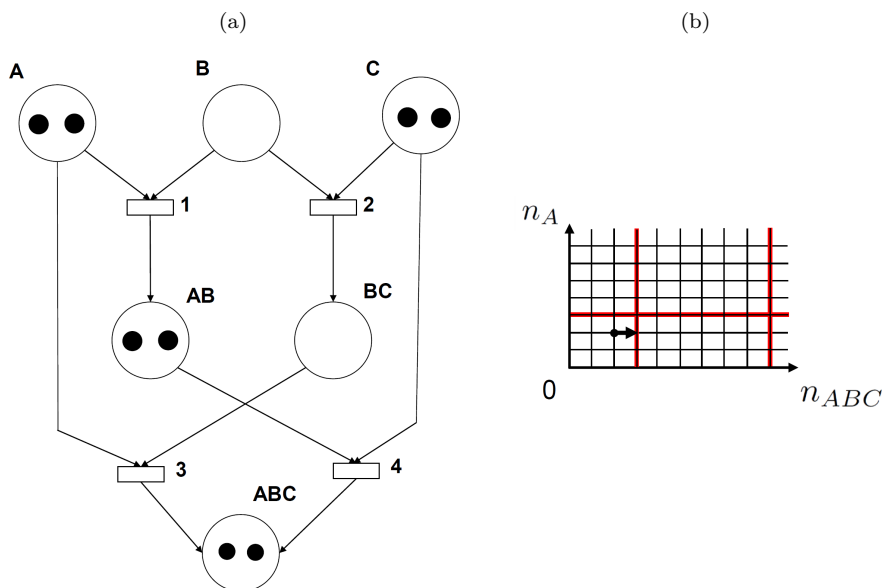

Figure 7: Illustration of the limiting resource constraint for interval crossing on the case study of the model with an adaptor. (a) Petri Net representation of the adaptor model at the state  $n_A = 2$ ,  $n_B = 0$ ,  $n_C = 2$ ,  $n_{AB} = 2$ ,  $n_{BC} = 2$  and  $n_{ABC} = 2$ , where  $n_A$ ,  $n_B$ ,  $n_C$ ,  $n_{AB}$ ,  $n_{BC}$  and  $n_{ABC}$  are the number of instances of the chemical species  $A$ ,  $B$ ,  $C$ ,  $AB$ ,  $BC$  and  $ABC$  respectively. (b) Transition triggered after the application of the fourth reaction at the state indicated in Fig. 7(a). Black lines denote the number of instances of the chemical species whereas red ones represent the boundaries of the sampling intervals. The number of instances of  $ABC$  has just reached its next sampling interval after the occurrence of the fourth reaction. But now there is not enough resources of  $A$ s and  $C$ s so that the number of instances of  $ABC$ s reaches its next sampling interval.

Such an approach can be used to refine the constraints accounting for limiting resources, since not only there must be enough resources so that the number of instances of a given chemical species may reach a given sampling interval, but also a sampling interval should be reached through a trace in which low priority reactions are not used too often. When defining priorities in logical modelling [13], this execution assumption is pushed to the extreme case, that is to say that we assume that higher priority level reactions entirely preempt lower priority level ones. In our case studies, the results are robust: we obtain the same results using either one or the other assumption. Taking this kind of constraints into account in our approach leads to the suppression of the transitions forbidden by these constraints. Figure 9 shows the resulting qualitative model for the case study with a unary and a binary reaction, starting again from the same initial states as in Figure 6.

We applied our analysis refined with the three kinds of constraints to our case studies, using our prototype implementation to automatically derive qualitative models with our approach [14]. The resulting models account for the properties of interest of our case studies. In particular, it is able to capture the sequestration effect appearing in the model with adaptor. Figure 10 shows the behaviour of the qualitative model derived for this case study in the situation where we start from initial states with a very high level of  $B$  and low levels of  $A$  and  $C$ . Here we see that the level of  $ABC$  always remain very low, below

the initial level of  $A$  and  $C$ , therefore accounting for the sequestration effect. A detailed analysis of the application of our approach to our case studies will be presented in Section 6. Before, in the following sections, we describe the formalisation of our approach.

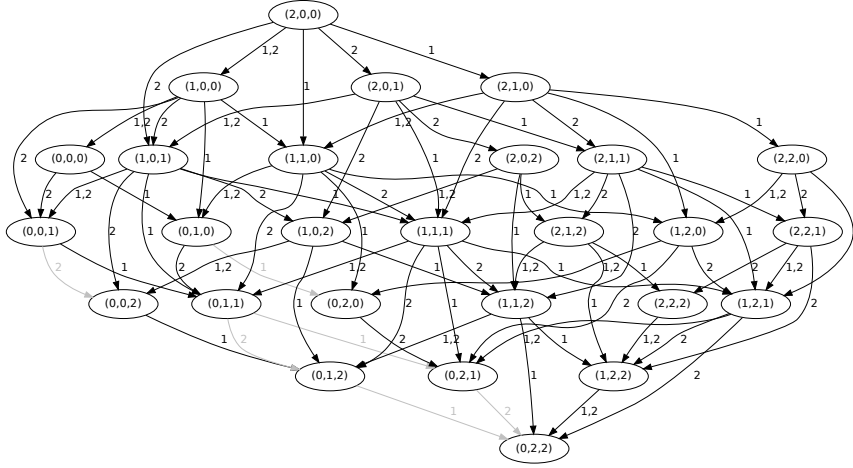

Figure 8: Behaviour of the qualitative model for the case study of the race between a unary and a binary reaction refined with the constraint of limiting resources for interval crossing, starting from initial states with high levels of  $A$  and very low levels of  $B$  and  $C$  (node  $(2,0,0)$ ). A node  $(n_A^\#, n_B^\#, n_C^\#)$  represents a qualitative state for which the level of  $A$ ,  $B$  and  $C$  is  $n_A^\#$ ,  $n_B^\#$  and  $n_C^\#$  respectively. Arrows denote transitions resulting from the application of the reactions labelling the arrow. Reaction 1 denotes the unary reaction whereas reaction 2 denotes the binary one. The transitions that can be discarded by the constraint of limiting resources are depicted in grey.

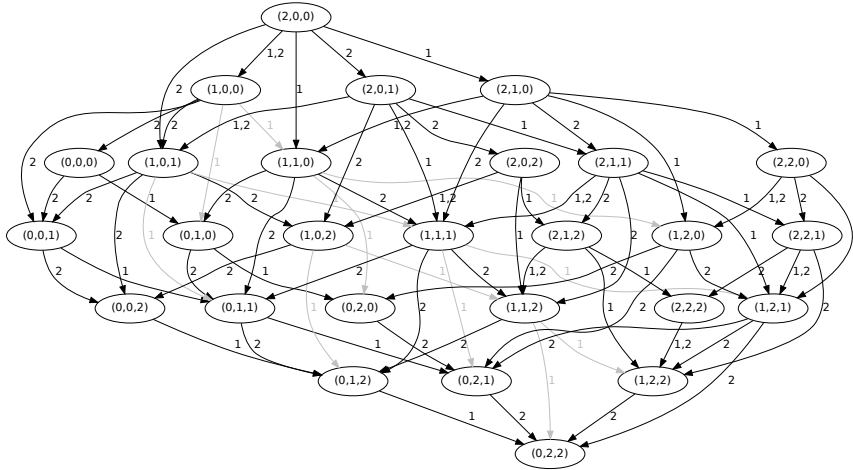

Figure 9: Behaviour of the qualitative model for the case study of a race between a unary and a binary reaction, refined with time scale separation, starting from initial states with high levels of  $A$  and very low levels of  $B$  and  $C$  (node  $(2,0,0)$ ). The transitions discarded by the refinement are depicted in grey.

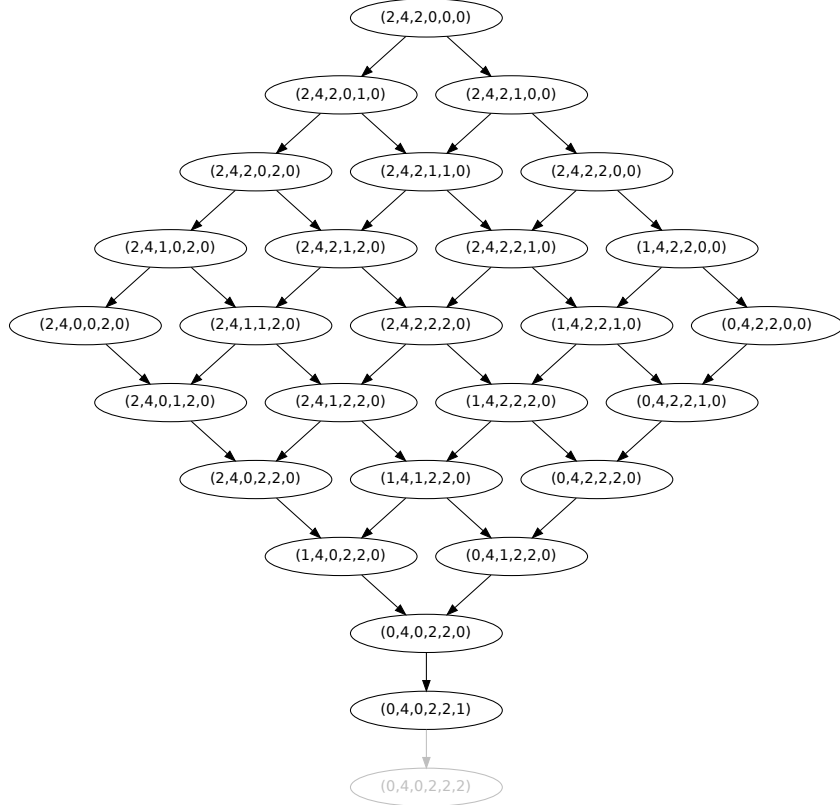

Figure 10: Behaviour of the qualitative model refined with the three kinds of constraints (the mass invariants, the limiting resources for interval crossing and time scale separation) for the case study of the model with an adaptor, starting from initial states with very high levels of  $B$ , low levels of  $A$  and  $C$  and very low levels of  $AB$ ,  $BC$  and  $ABC$  (node  $(2,4,2,0,0,0)$ ), under the modelling assumptions stated in Section 6. A node  $(n_A^\#, n_B^\#, n_C^\#, n_{AB}^\#, n_{BC}^\#, n_{ABC}^\#)$  represents a qualitative state for which the level of  $A$ ,  $B$ ,  $C$ ,  $AB$ ,  $BC$  and  $ABC$  is  $n_A^\#, n_B^\#, n_C^\#, n_{AB}^\#, n_{BC}^\#$  and  $n_{ABC}^\#$  respectively. Arrows denote single or multiple transitions. The reactions associated with the transitions are omitted. The transitions discarded by the constraint of limiting resources on interval crossing are depicted in grey.

### 3. Trace semantics

We want to design a framework to automatically abstract qualitative models from reaction networks. Following a formal approach, we will relate the behaviour of the abstract model with the behaviour of the reaction network. Thus, the first task is to provide a formal definition for the behaviour of reaction networks. In this section, we describe this behaviour qualitatively in terms of a set of traces. Partial information about reaction kinetics will be taken into account in Section 5.3.

Firstly, we give the definition of a reaction network.

**Definition 1 (Reaction network).** A network  $R$  of  $n$  reactions is a pair  $(\nu, (M_r, V_r)_{1 \leq r \leq n})$ , where:

- (1)  $\nu$  is a set of chemical species;
- (2) for each integer  $r$  between 1 and  $n$ :
  - (a)  $M_r : \nu \rightarrow \mathbb{N}$  is a multi-set of chemical species,
  - (b)  $V_r : \nu \rightarrow \mathbb{Z}$  is a reaction vector,
 such that  $M_r(x) + V_r(x) \geq 0$  for any chemical species  $x \in \nu$ .

In Definition 1, a pair  $(M_r, V_r)$  is called a reaction. In a reaction  $(M_r, V_r)$ , the multi-set  $M_r$  encodes the set of the reactants (with their multiplicities) whereas the vector  $V_r$  denotes how many chemical species of each kind is produced and consumed at each application of the reaction. Lastly, for each chemical species  $x \in \nu$ , the following constraint:

$$M_r(x) + V_r(x) \geq 0,$$

ensures that the reaction  $r$  does not consume more instances of the chemical species  $x$  than available in the system. A list of symbols used in the text with their description is provided in Table 1.

**Example 1.** *Let us illustrate our definition of a reaction network on the case study with a competition between a unary reaction and a binary reaction (Section 2):*

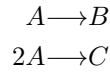

Three chemical species  $A$ ,  $B$  and  $C$  compose this system. Thus the set of chemical species is  $\nu = \{A, B, C\}$ . The set of reactants of the unary reaction is reduced to  $A$  with a multiplicity of 1. The associated multiset  $M_1$  is thus:

$$M_1 : \begin{cases} A \mapsto 1, \\ B \mapsto 0, \\ C \mapsto 0. \end{cases}$$

The result of the application of the unary reaction is the consumption of 1 instance of  $A$  and the production of 1 instance of  $B$ . The associated reaction vector  $V_1$  is thus:

$$V_1 : \begin{cases} A \mapsto -1, \\ B \mapsto 1, \\ C \mapsto 0. \end{cases}$$

Considering the binary reaction, its set of reactants is  $A$  with a multiplicity of 2. The associated multiset  $M_2$  is thus:

$$M_2 : \begin{cases} A \mapsto 2, \\ B \mapsto 0, \\ C \mapsto 0. \end{cases}$$

The result of the application of the binary reaction is the consumption of 2 instances of  $A$  and the production of 1 instance of  $C$ . The associated reaction vector  $V_2$  is thus:

$$V_2 : \begin{cases} A \mapsto -2, \\ B \mapsto 0, \\ C \mapsto 1. \end{cases}$$

We can now formally define the set of transitions of a reaction network.

**Definition 2 (Transition system).** A reaction network  $R$  induces a transition system  $(\mathcal{Q}_R, T_R)$  where:

- (i)  $\mathcal{Q}_R$  is the set  $\mathbb{N}^\nu$  of the functions between  $\nu$  and  $\mathbb{N}$ ;
- (ii)  $T_R$  is the subset of  $\mathbb{N}^\nu \times \llbracket 1, n \rrbracket \times \mathbb{N}^\nu$  that contains all the triple  $(q, r, q')$  such that, for all chemical species  $x \in \nu$ :
  - (a)  $M_r(x) \leq q(x)$  and
  - (b)  $q'(x) = q(x) + V_r(x)$ ,

where  $R \triangleq (\nu, (M_r, V_r)_{1 \leq r \leq n})$ .

In Definition 2, the notation  $\llbracket 1, n \rrbracket$  denotes the set of the integers between 1 and  $n$ . The set  $\mathcal{Q}_R$  denotes all the potential states of the system. At this level of abstraction, the state of the system describes the number of instances of each kind of chemical species. The elements of  $T_R$  are called the transitions of the system. Transitions define the result of the applications of reactions. More precisely, a triple  $(q, r, q') \in T_R$  denotes the fact that the system can jump from the state  $q$  to the state  $q'$  by applying the rule indexed by the integer  $r$ . Condition (iia) ensures that enough reactants are available, whereas condition (iib) encodes the consumption/production of the chemical species. We notice that the resulting transition system is equivalent to a Petri net [12], in which each kind of chemical species is denoted by a placeholder and each instance by a token.

Before defining the traces of a reaction network, we introduce some notations. For any two sets  $A$  and  $\Sigma$ , and any subset  $T$  of the set  $A \times \Sigma \times A$ , we call a pretrace of elements of  $A$  and transitions in  $T$ , any element of the set  $A \times T^*$ . In a pretrace:

$$\tau \triangleq (a'_0, (a_i, \lambda_i, a'_i)_{1 \leq i \leq k}),$$

the element  $a'_0$  (resp.  $a'_k$ ) is called the initial (resp. final) state of the pretrace  $\tau$  and is denoted as  $first(\tau)$  (resp.  $final(\tau)$ ). The second component of a pretrace is a (potentially empty) sequence of triples in  $T$ . Moreover, the pretrace  $\tau$  is called a trace if  $a_i = a'_{i-1}$  for any integer  $i$  between 1 and  $k$ . Lastly, given a triple  $(a_{k+1}, \lambda_{k+1}, a'_{k+1})$  in  $T$ , we denote by:

$$\tau \frown (a_{k+1}, \lambda_{k+1}, a'_{k+1})$$

the following pretrace:

$$(a'_0, (a_i, \lambda_i, a'_i)_{1 \leq i \leq k+1}),$$

that is obtained by adding the transition  $(a_{k+1}, \lambda_{k+1}, a'_{k+1})$  at the end of the pretrace  $\tau$ .

We can now properly define the trace semantics of a reaction network.

**Definition 3 (Trace semantics).** The set of traces that is induced by a reaction network  $R$  and a set of initial states  $\mathcal{Q}_{R,0} \subseteq \mathcal{Q}_R$  is defined as the set of the traces  $\tau$  of elements of  $\mathcal{Q}_R$  and transitions in  $T_R$  such that  $first(\tau) \in \mathcal{Q}_{R,0}$ .

We denote by  $\mathcal{T}_{R,\mathcal{Q}_{R,0}}$  the set of traces that is induced by the reaction network  $R$  and the set of the initial states  $\mathcal{Q}_{R,0}$ .

**Example 2.** Figure 3 illustrates the notion of trace semantics on the model with the adaptor (Section 2). Figure 3(a) shows the Petri net representation of the reaction network of the model for the set of initial states  $\mathcal{Q}_{R,0} = \{q\}$ , where the state  $q$  is defined as follows:

$$q : \begin{cases} A & \mapsto 2, \\ B & \mapsto 1, \\ C & \mapsto 2, \\ AB & \mapsto 0, \\ BC & \mapsto 0, \\ ABC & \mapsto 0. \end{cases}$$

Figure 3(b) displays the induced transition system. Starting from the initial state, reaction 1 (resp. reaction 2) can occur giving rise to a transition resulting in the consumption of 1 instance of  $A$  and  $B$  (resp. 1 instance of  $B$  and  $C$ ) and the production of 1 instance of  $AB$  (resp.  $BC$ ). Reaction 3 (resp. reaction 4) can then be instantiated giving rise to a transition resulting in the consumption of 1 instance of  $AB$  and  $C$  (resp. 1 instance of  $A$  and  $BC$ ) and the production of 1 instance of  $ABC$ . No reaction can then occur as there are not enough reactants available.

Altogether the traces that are induced by the reaction network and the initial state are:

$$\begin{aligned} & (2, 1, 2, 0, 0, 0), \\ & (2, 1, 2, 0, 0, 0) \xrightarrow{1} (1, 0, 2, 1, 0, 0), \\ & (2, 1, 2, 0, 0, 0) \xrightarrow{2} (2, 0, 1, 0, 1, 0), \\ & (2, 1, 2, 0, 0, 0) \xrightarrow{1} (1, 0, 2, 1, 0, 0) \xrightarrow{3} (1, 0, 1, 0, 0, 1), \\ & (2, 1, 2, 0, 0, 0) \xrightarrow{2} (2, 0, 1, 0, 1, 0) \xrightarrow{4} (1, 0, 1, 0, 0, 1), \end{aligned}$$

where a state  $q$  is denoted by the sextuple  $(q(A), q(B), q(C), q(AB), q(BC), q(ABC))$  and a transition  $(q, r, q')$  as  $q \xrightarrow{r} q'$ .

Following the abstract interpretation framework [15], we can also express the trace semantics as the least fixpoint of a monotonic function over the powerset of pretraces  $\wp(\mathcal{Q}_R \times T_R^*)$ . Let  $\mathbb{F}_{\mathcal{Q}_{R,0}}$  be the following function:

$$\mathbb{F}_{\mathcal{Q}_{R,0}} : \begin{cases} \wp(\mathcal{Q}_R \times T_R^*) \rightarrow \wp(\mathcal{Q}_R \times T_R^*) \\ X \mapsto \mathcal{Q}_{R,0} \cup \{\tau \frown (q, r, q') \mid \tau \in X \wedge (q, r, q') \in T_R \wedge q = final(\tau)\}. \end{cases}$$



Roughly speaking, the function  $\mathbb{F}_{\mathcal{Q}_{R,0}}$  maps any set of pretraces  $X$  to the set of pretraces that can be obtained by continuing a pretrace in the set  $X$  with a transition in  $T_R$ . We notice that the function  $\mathbb{F}_{\mathcal{Q}_{R,0}}$  is a monotonic function, that is to say that:

$$X \subseteq Y \Rightarrow \mathbb{F}_{\mathcal{Q}_{R,0}}(X) \subseteq \mathbb{F}_{\mathcal{Q}_{R,0}}(Y).$$

Since additionally the function  $\mathbb{F}_{\mathcal{Q}_{R,0}}$  is defined over a powerset, it has a least fixpoint [16]. This least fixpoint,  $\text{lfp } \mathbb{F}_{\mathcal{Q}_{R,0}}$ , is indeed the set of all the traces of the reaction network  $R$ , that is to say that:

$$\text{lfp } \mathbb{F}_{\mathcal{Q}_{R,0}} = \mathcal{T}_{R,\mathcal{Q}_{R,0}}.$$

Moreover, the function  $\mathbb{F}_{\mathcal{Q}_{R,0}}$  is  $\cup$ -continuous, that is to say that:

$$\mathbb{F}_{\mathcal{Q}_{R,0}}\left(\bigcup\{X_j \mid j \in J\}\right) = \bigcup\{\mathbb{F}_{\mathcal{Q}_{R,0}}(X_j) \mid j \in J\}$$

for any family  $(X_j)_{j \in J}$  of sets of pretraces. It follows from [17] that the least fixpoint of  $\mathbb{F}_{\mathcal{Q}_{R,0}}$  can also be expressed as the limit of the finite iterates of the function  $\mathbb{F}_{\mathcal{Q}_{R,0}}$ , that is to say that:

$$\mathcal{T}_{R,\mathcal{Q}_{R,0}} = \bigcup\{\mathbb{F}_{\mathcal{Q}_{R,0}}^i(\emptyset) \mid i \in \mathbb{N}\},$$

which provides an iterative algorithm to enumerate the traces of the network  $R$ .

#### 4. Derivation of a coarse-grained qualitative semantics

The semantics described in Section 3 is too fine grained. In particular, each instance of a protein is taken into account. Usually, in a qualitative model, the number of instances of proteins is sampled within a finite number of intervals. In this section, we will use the abstract interpretation framework to derive such an abstraction. Abstract interpretation [15] is a unifying framework for the approximation of mathematical structures. It offers formal tools to relate the observations of the behaviour of a system at different levels of details. It can also be used to systematically derive static analysers (that provide effective definitions of semantics at coarser levels of abstraction).

We use a simple version of the abstract interpretation framework that consists in removing some information from values, states and traces. Our abstraction is twofold. Firstly, we sample the number of instances of chemical species within a finite number of intervals. Secondly, we remove in traces the transitions for which the number of instances of each chemical species remains in the same interval. To sample the number of instances and later the rate of reactions (see Section 5.3), we partition the set  $\mathbb{R}^+$  over the  $p + 1$  intervals  $\llbracket 0, \delta \llbracket$ ,  $\llbracket \delta^i, \delta^{i+1} \llbracket$  for each integer  $i$  between 1 and  $p - 1$ , and  $\llbracket \delta^p, \infty \llbracket$ , where  $p$  and  $\delta$  are integer parameters such that  $\delta \geq 2$  and  $p \geq 1$ .

We introduce a function  $\beta^{\mathbb{R}}$  to sample non-negative real numbers over this partition:

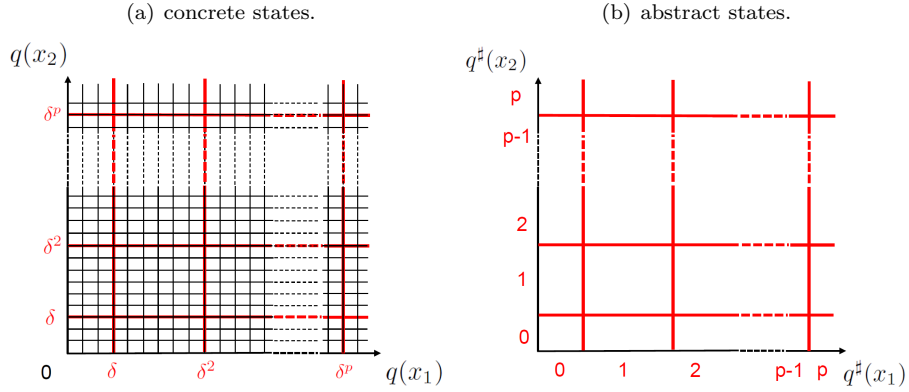

Figure 11: Abstraction of values. The domain of states (here  $\mathbb{R}^2$ ) is partitioned by intervals (represented by the red lines) following a geometric progression, parametrised by  $\delta$  (Fig. 11(a)). The number of instances (denoted by the black lines) in each interval is then abstracted away and the intervals are mapped to their corresponding abstract values (Fig. 11(b)).

**Definition 4 (abstract values).** We define the function  $\beta^{\mathbb{R}}$  between the set  $\mathbb{R}^+$  and the set  $\llbracket 0, p \rrbracket$  as follows:

$$\beta^{\mathbb{R}} : \begin{cases} \mathbb{R}^+ \rightarrow \llbracket 0, p \rrbracket \\ v \mapsto \min(\{p\} \cup \{k \in \llbracket 0, p \rrbracket \mid v < \delta^{k+1}\}) \end{cases}.$$

This way, the function  $\beta^{\mathbb{R}}$  maps each positive real number  $v \in \mathbb{R}^+$  into the least integer in the set  $\{p\} \cup \{k \in \llbracket 0, p \rrbracket \mid v < \delta^{k+1}\}$ . This abstraction is depicted in Figure 11.

Then we lift the function  $\beta^{\mathbb{R}}$  over transition systems.

**Definition 5 (abstract transition system).** A reaction network  $R$  induces an abstract transition system  $(\mathcal{Q}_R^{\sharp}, T_R^{\sharp})$  where:

- (i)  $\mathcal{Q}_R^{\sharp}$  is the set  $\llbracket 0, p \rrbracket^{\nu}$  of the functions between the set of the chemical species  $\nu$  and the integer interval  $\llbracket 0, p \rrbracket$ ;
- (ii)  $T_R^{\sharp}$  is the subset of  $\llbracket 0, p \rrbracket^{\nu} \times \llbracket 1, n \rrbracket \times \llbracket 0, p \rrbracket^{\nu}$  that is defined by  $(q^{\sharp}, r, q^{\sharp'}) \in T_R^{\sharp}$  if and only if there exist  $(q, r, q')$  such that:

$$q^{\sharp} = \beta^{\mathbb{R}} \circ q \text{ and } q^{\sharp'} = \beta^{\mathbb{R}} \circ q'.$$

Thus, the abstract transition system is obtained by applying component-wise the function  $\beta^{\mathbb{R}}$  in the states of the transition system and in the states that occur in transitions. We denote by  $\beta^{\mathcal{Q}}$  the following function:

$$\beta^{\mathcal{Q}} : \begin{cases} \mathcal{Q}_R \rightarrow \mathcal{Q}_R^{\sharp} \\ q \mapsto \beta^{\mathbb{R}} \circ q. \end{cases}$$

The function  $\beta^{\mathcal{Q}}$  maps each state  $q \in \mathcal{Q}_R$  into the abstract state  $\beta^{\mathbb{R}} \circ q \in \mathcal{Q}_R^{\sharp}$  by applying the abstraction function  $\beta^{\mathbb{R}}$  component-wise on the number of instances of each species.

Then the abstraction  $\beta^{\mathcal{Q}}$  can be lifted to pretraces and traces. We call an abstract pretrace (resp. an abstract trace) any pretrace (resp. trace) of elements

of  $\mathcal{Q}_R^\sharp$  and transitions in  $T_R^\sharp$ . We denote by  $\beta_1^\mathcal{T}$  the function between the set  $\mathcal{Q}_R \times T_R^*$  and the set  $\mathcal{Q}_R^\sharp \times T_R^{\sharp*}$  that is defined as follows:

$$\beta_1^\mathcal{T} : \left\{ \begin{array}{l} \mathcal{Q}_R \times T_R^* \quad \rightarrow \mathcal{Q}_R^\sharp \times T_R^{\sharp*} \\ (q_0', (q_i, r_i, q_i')_{1 \leq i \leq k}) \mapsto (\beta^\mathcal{Q}(q_0'), (\beta^\mathcal{Q}(q_i), r_i, \beta^\mathcal{Q}(q_i'))_{1 \leq i \leq k}). \end{array} \right.$$

Roughly speaking, the function  $\beta_1^\mathcal{T}$  applies the abstraction function  $\beta^\mathcal{Q}$  over each state that occurs in a trace (or a pretrace).

We notice that there exists some abstract transitions  $(q^\sharp, r, q^{\sharp'}) \in T_R^\sharp$  such that  $q^\sharp = q^{\sharp'}$ . Indeed, even if a concrete transition changes the number of instances of a chemical species, this does not always make it exit its sampling interval. We call such transitions silent and we denote by  $T_{R/\varepsilon}^\sharp$  the set of the non silent abstract transitions. In order to remove silent transitions, we define the function  $\beta_2^\mathcal{T}$  between the set  $\mathcal{Q}_R^\sharp \times T_R^{\sharp*}$  and the set  $\mathcal{Q}_R^\sharp \times T_{R/\varepsilon}^{\sharp*}$  as follows:

$$\beta_2^\mathcal{T} : \left\{ \begin{array}{l} \mathcal{Q}_R^\sharp \times T_R^{\sharp*} \quad \rightarrow \mathcal{Q}_R^\sharp \times T_{R/\varepsilon}^{\sharp*} \\ (q_0^{\sharp'}, (q_i^\sharp, r_i, q_i^{\sharp'})) \mapsto (q_0^{\sharp'}, (q_{\sigma(i)}^\sharp, r_{\sigma(i)}, q_{\sigma(i)}^{\sharp'})), \end{array} \right.$$

where  $\sigma(i)$  ranges over the set  $\{i \in \llbracket 1, k \rrbracket \mid q_i^\sharp \neq q_i^{\sharp'}\}$  in increasing order. We notice that the function  $\beta_2^\mathcal{T}$  removes the transitions between identical abstract states from abstract pretraces.

**Example 3.** Figure 12 shows an illustration of the application of the functions  $\beta_1^\mathcal{T}$  and  $\beta_2^\mathcal{T}$ , in a 2-dimensional case (considering 2 chemical species  $x_1$  and  $x_2$ ), on the abstraction of the following concrete trace (for which we omit the reactions for sake of clarity):

$$\begin{aligned} \tau &= (0, 1) \longrightarrow (1, 1) \longrightarrow (1, 3) \longrightarrow (2, 3) \longrightarrow (3, 3) \\ &\longrightarrow (4, 3) \longrightarrow (4, 5) \longrightarrow (5, 5) \longrightarrow (6, 5) \end{aligned}$$

where we denote a state  $q$  by the couple  $(q(x_1), q(x_2))$  (see Fig.12(a)). Here we assume that  $\delta = 2$ . Abstracting first the states of the transitions composing the trace (by applying the function  $\beta_1^\mathcal{T}$  to the trace), we get:

$$\begin{aligned} \beta_1^\mathcal{T}(\tau) &= (0, 0) \longrightarrow (0, 0) \longrightarrow (0, 1) \longrightarrow (1, 1) \longrightarrow (1, 1) \\ &\longrightarrow (2, 1) \longrightarrow (2, 2) \longrightarrow (2, 2) \longrightarrow (2, 2). \end{aligned}$$

where we denote an abstract state  $q^\sharp$  by the couple  $(q^\sharp(x_1), q^\sharp(x_2))$  (see Fig. 12(b)). Removing then the silent abstract transitions (by applying the function  $\beta_2^\mathcal{T}$ ), we get:

$$\beta_2^\mathcal{T}(\beta_1^\mathcal{T}(\tau)) = (0, 0) \longrightarrow (0, 1) \longrightarrow (1, 1) \longrightarrow (2, 1) \longrightarrow (2, 2).$$

(see Fig. 12(c)).

Now we are ready to define our abstraction function over traces. We introduce the function  $\beta^\mathcal{T}$  between the set of concrete (pre)traces  $\mathcal{Q}_R \times T_R^*$  and the set of abstract (pre)traces  $\mathcal{Q}_R^\sharp \times T_{R/\varepsilon}^{\sharp*}$  as follows:

$$\beta^\mathcal{T} : \left\{ \begin{array}{l} \mathcal{Q}_R \times T_R^* \rightarrow \mathcal{Q}_R^\sharp \times T_{R/\varepsilon}^{\sharp*} \\ \tau \quad \mapsto \beta_2^\mathcal{T}(\beta_1^\mathcal{T}(\tau)). \end{array} \right.$$

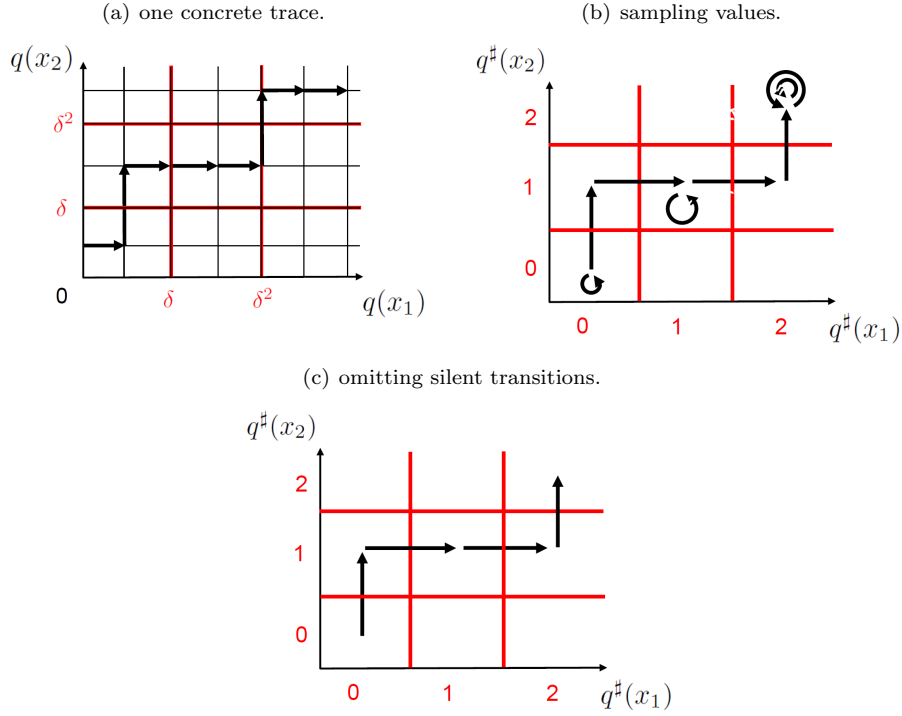

Figure 12: Abstraction of traces. Fig. 12(a) shows an example of a concrete trace in a 2-dimensional case (i.e. considering 2 chemical species  $x_1$  and  $x_2$ ). We here assume  $\delta = 2$ . Following the abstraction of values, the domain of values is partitioned by intervals (represented by the red lines) and the number of instances (denoted by the black lines) in each interval is abstracted away. The states of the transitions composing a trace are then mapped to their corresponding abstract states (Fig. 12(b)). Finally the transitions which have no effect on the abstract states (represented by the self-loops) are removed from the trace (Fig. 12(c)). The reactions associated to the transitions are here omitted.

Indeed, the function  $\beta^{\mathcal{T}}$  is the composition of the functions  $\beta_2^{\mathcal{T}}$  and  $\beta_1^{\mathcal{T}}$ .

The function  $\beta^{\mathcal{T}}$  can be used to abstract the computation of the trace semantics. Given a set of initial states  $\mathcal{Q}_{R,0} \subseteq \mathcal{Q}_R$ , we introduce the function  $\mathbb{F}_{\mathcal{Q}_{R,0}}^\sharp$  over the powerset of abstract (pre)traces  $\wp(\mathcal{Q}_R^\sharp \times T_{R/\varepsilon}^{\sharp*})$  as follows:

$$\mathbb{F}_{\mathcal{Q}_{R,0}}^\sharp : \begin{cases} \wp(\mathcal{Q}_R^\sharp \times T_{R/\varepsilon}^{\sharp*}) \rightarrow \wp(\mathcal{Q}_R^\sharp \times T_{R/\varepsilon}^{\sharp*}) \\ Y \mapsto \alpha^{\mathcal{T}}(\mathbb{F}_{\mathcal{Q}_{R,0}}(\gamma^{\mathcal{T}}(Y))), \end{cases}$$

where:

(i) the function  $\alpha^{\mathcal{T}}$  is defined as follows:

$$\alpha^{\mathcal{T}} : \begin{cases} \wp(\mathcal{Q}_R \times T_R^*) \rightarrow \wp(\mathcal{Q}_R^\sharp \times T_{R/\varepsilon}^{\sharp*}) \\ X \mapsto \{\beta^{\mathcal{T}}(x) \in \mathcal{Q}_R^\sharp \times T_{R/\varepsilon}^{\sharp*} \mid x \in X\}; \end{cases} ;$$

(ii) the function  $\gamma^{\mathcal{T}}$  is defined as follows:

$$\gamma^{\mathcal{T}} : \begin{cases} \wp(\mathcal{Q}_R^\sharp \times T_{R/\varepsilon}^{\sharp*}) \rightarrow \wp(\mathcal{Q}_R \times T_R^*) \\ Y \mapsto \{x \in \mathcal{Q}_R \times T_R^* \mid \beta^{\mathcal{T}}(x) \in Y\}. \end{cases}$$

(see p.15 for a definition of the function  $\mathbb{F}_{\mathcal{Q}_{R,0}}$ ). Roughly speaking the function  $\alpha^{\mathcal{T}}$  maps each set of concrete (pre)traces to the set of their abstractions. This is, indeed, the best abstraction of a set of traces with respect to our abstraction  $\beta^{\mathcal{T}}$  over (pre)traces. Conversely, the function  $\gamma^{\mathcal{T}}$  maps each set of abstract (pre)traces to the set of the concrete traces which can be abstracted into one of these abstract traces. Given a subset of concrete (pre)traces  $X \subseteq \mathcal{Q}_R \times T_R^*$  and a subset of abstract (pre)traces  $Y \subseteq \mathcal{Q}_R^\sharp \times T_{R/\varepsilon}^{\sharp*}$ , the property  $\alpha^{\mathcal{T}}(X) \subseteq Y$  is equivalent to the property  $X \subseteq \gamma^{\mathcal{T}}(Y)$ . Such a pair of functions is called a Galois connection [15], which is usually denoted as follows:

$$\wp(\mathcal{Q}_R \times T_R^*) \xleftarrow{\gamma^{\mathcal{T}}} \wp(\mathcal{Q}_R^\sharp \times T_{R/\varepsilon}^{\sharp*}) \xrightarrow{\alpha^{\mathcal{T}}}$$

A Galois connection ensures that each set of concrete elements (here concrete (pre)traces) has a best abstraction in the abstract. Moreover, it ensures that the function  $\alpha^{\mathcal{T}} \circ \mathbb{F}_{\mathcal{Q}_{R,0}} \circ \gamma^{\mathcal{T}}$  is the most precise counterpart to the function  $\mathbb{F}_{\mathcal{Q}_{R,0}}$ , that is to say that:

- (1) for each set  $Y \in \wp(\mathcal{Q}_R^\sharp \times T_{R/\varepsilon}^{\sharp*})$  of sets of abstract (pre)traces, we have:

$$\mathbb{F}_{\mathcal{Q}_{R,0}}(\gamma^{\mathcal{T}}(Y)) \subseteq \gamma^{\mathcal{T}}(\mathbb{F}_{\mathcal{Q}_{R,0}}^\sharp(Y));$$

- (2) and for any function  $\mathbb{G}$  over the set  $\wp(\mathcal{Q}_R^\sharp \times T_{R/\varepsilon}^{\sharp*})$  of sets of abstract (pre)traces such that:

$$\mathbb{F}_{\mathcal{Q}_{R,0}}(\gamma^{\mathcal{T}}(Y)) \subseteq \gamma^{\mathcal{T}}(\mathbb{G}(Y)),$$

for each set  $Y \in \wp(\mathcal{Q}_R^\sharp \times T_{R/\varepsilon}^{\sharp*})$ , we have:

$$\mathbb{F}_{\mathcal{Q}_{R,0}}^\sharp(Y) \subseteq \mathbb{G}(Y),$$

for each set  $Y \in \wp(\mathcal{Q}_R^\sharp \times T_{R/\varepsilon}^{\sharp*})$ .

We define the Galois connections  $(\alpha^{\mathbb{R}}, \gamma^{\mathbb{R}})$  (resp.  $(\alpha^{\mathcal{Q}}, \gamma^{\mathcal{Q}})$ ) between sets of concrete values (resp. states) and sets of abstract values (resp. states) the same way.

The function  $\mathbb{F}_{\mathcal{Q}_{R,0}}^\sharp$  is monotonic. Thus, by [16], it has a least fixpoint.

**Definition 6 (abstract trace semantics).** The set of abstract traces  $\mathcal{T}_{\mathcal{Q}_{R,0}}^\sharp$  that is induced by a reaction network  $R$  and a set of initial states  $\mathcal{Q}_{R,0} \subseteq \mathcal{Q}_R$  is defined as the least fixpoint  $\text{lfp } \mathbb{F}_{\mathcal{Q}_{R,0}}^\sharp$  of the function  $\mathbb{F}_{\mathcal{Q}_{R,0}}^\sharp$ .

The Galois connection  $(\alpha^{\mathcal{T}}, \beta^{\mathcal{T}})$  can be used to transfer the computation of the concrete fixpoint  $\mathcal{T}_{R,\mathcal{Q}_{R,0}} = \text{lfp } \mathbb{F}_{\mathcal{Q}_{R,0}}$  in the abstract.

**Theorem 1 (fixpoint transfer).** Let  $R$  be a reaction network and  $\mathcal{Q}_{R,0} \subseteq \mathcal{Q}_R$  a set of initial states.

Then the set  $\text{lfp } \mathbb{F}_{\mathcal{Q}_{R,0}}$  is a subset of the set  $\gamma^{\mathcal{T}}(\text{lfp } \mathbb{F}_{\mathcal{Q}_{R,0}}^\sharp)$ .

We have used the Galois connection  $(\alpha^{\mathcal{T}}, \gamma^{\mathcal{T}})$  so as to abstract the trace semantics. Theorem 1 ensures that our abstraction is conservative, i.e. all the traces of the concrete semantics are taken into account. Moreover, the set of abstract traces can be computed by iterating the function  $\alpha^{\mathcal{T}} \circ \mathbb{F}_{\mathcal{Q}_{R,0}} \circ \gamma^{\mathcal{T}}$ . This consists in, at each step, (a) computing the concretization of the set of traces, (b) making the computation in the concrete, and (c) abstract the result.

The following property provides a direct way to make this computation without going back and forth in the concrete, and gives more intuition about what information is lost with our abstraction. We introduce the following notations:

- we denote by  $V_{\infty}$  (resp.  $M_{\infty}$ ) the greatest element among the set  $\{|V_i(x)| \mid i \in \llbracket 1, n \rrbracket, x \in \nu\}$  (resp. among the set  $\{M_i(x) \mid i \in \llbracket 1, n \rrbracket, x \in \nu\}$ ), and denote by  $(M+V)_{\infty}$  the greatest element among the set  $\{|M_i(x)+V_i(x)| \mid i \in \llbracket 1, n \rrbracket, x \in \nu\}$ ;
- for any integer  $z \in \mathbb{Z}$ , we define the sign  $sign(z)$  of  $z$  as:
  - (1)  $sign(0) \triangleq 0$ , and
  - (2)  $sign(z) \triangleq z/|z|$  if  $z \neq 0$ ;
- for any function  $f$  between two sets  $A$  and  $B$  and any elements  $y \in A$  and  $v \in B$ , we define  $f[y \mapsto v]$  as the function between  $A$  and  $B$  mapping the element  $y$  to the element  $v$ , and any element  $x \in A \setminus \{y\}$  to the element  $f(x)$ .

**Property 1.** *The following assertions hold:*

- (1) *For any part  $Y \subseteq \mathcal{Q}_R^{\#} \times T_{R/\varepsilon}^{\#\star}$ , the following inclusion:*

$$\mathbb{F}_{\mathcal{Q}_{R,0}}^{\#}(Y) \subseteq Y \cup \alpha^{\mathcal{Q}}(\mathcal{Q}_{R,0}) \cup \left\{ \tau^{\#} \frown (q^{\#}, r, q^{\#\prime}) \left| \begin{array}{l} \tau^{\#} \in Y \\ \wedge (q^{\#}, r, q^{\#\prime}) \in T_{R/\varepsilon}^{\#} \\ \wedge final(\tau^{\#}) = q^{\#} \end{array} \right. \right\},$$

*is satisfied.*

- (2) *If for any concrete transition  $(q, r, q') \in T_R$  such that  $(\beta^{\mathcal{Q}}(q), r, \beta^{\mathcal{Q}}(q')) \in T_{R/\varepsilon}^{\#}$ , there exist a state  $q''$  and a reaction  $r'$  such that  $(q'', r', q) \in T_R$  and  $\beta^{\mathcal{Q}}(q'') = \beta^{\mathcal{Q}}(q)$ , then for any part  $Y \subseteq \mathcal{Q}_R^{\#} \times T_{R/\varepsilon}^{\#\star}$ , the following inclusion:*

$$\alpha^{\mathcal{Q}}(\mathcal{Q}_{R,0}) \cup \left\{ \tau^{\#} \frown (q^{\#}, r, q^{\#\prime}) \left| \begin{array}{l} \tau^{\#} \in Y \\ \wedge (q^{\#}, r, q^{\#\prime}) \in T_{R/\varepsilon}^{\#} \\ \wedge final(\tau^{\#}) = q^{\#} \end{array} \right. \right\} \subseteq \mathbb{F}_{\mathcal{Q}_{R,0}}^{\#}(Y),$$

*is satisfied.*

- (3) *For any abstract transition  $(q^{\#}, r, q^{\#\prime}) \in T_R^{\#}$ , if  $\delta > V_{\infty}$ , then the value  $q^{\#\prime}(x)$  is either equal to  $q^{\#}(x)$  or to  $q^{\#}(x) + sign(V_r(x))$ .*
- (4) *For any rule  $r$  and any abstract state  $q^{\#} \in \mathcal{Q}_R^{\#}$ , if  $\delta > \max(M_{\infty}, (M+V)_{\infty})$ , then, for any chemical species  $y \in \nu$  such that  $V_r(y) \neq 0$  and  $0 \leq q^{\#}(y) + sign(V_r(y)) \leq p$ , we have:*

$$(q^{\#}, r, q^{\#}[y \mapsto q^{\#}(y) + sign(V_r(y))]) \in T_R^{\#}.$$

Properties 1.(1) and 1.(2) provide an inductive definition to compute the set of the abstract traces directly, without having to concretize the states. More precisely, Property 1.(1) proposes a sound over-approximation of the function  $\mathbb{F}_{\mathcal{Q}_{R,0}}^\sharp$ , that can be directly computed in the abstract domain. Moreover, in Property 1.(2), this abstraction is shown to be complete.

It is worth noting that the inclusion in Property 1.(1) would not have hold in general if we had not taken the extensive closure of the abstract function (the extensive closure of a function  $f$  over the subsets of a given set  $A$ , is the least function (component-wise) that is extensive and greater (component-wise) than the function  $f$ ; indeed the extensive closure of a function  $f$  is always mapping each subset  $X \subset A$ , to the subset  $X \cup f(X)$ ). Replacing a function by its extensive closure is not an issue, since a given function and its extensive closure have the same set of fixpoints [18].

Property 1.(2) shows that this abstraction is complete (that is to say that it introduces no spurious behaviour), under the assumption that for any concrete transition  $\tau$  such that its abstraction is not silent, there exists a concrete transition  $\tau'$  that is silent in the abstract and which final state is the initial state of  $\tau$ . This assumption models the fact that we ignore the difference between two states having the same abstraction. It is satisfied, if the parameter  $\delta$  is chosen large enough, or if we add a spurious reaction  $r$  with no reactant and no product in the system.

Property 1.(3) establishes the fact that it is not possible to cross a whole interval in a single transition. As formalised in Theorem 1, the abstract trace semantics is a safe over-approximation of the concrete trace semantics. Yet, this semantics introduces spurious behaviours. In particular, Property 1.(4) establishes that it is always possible to change the interval of a chemical species  $x \in \nu$  in the direction given by the sign of  $V_r(x)$ , when applying the rule that is indexed with the integer  $r$ , unless the chemical species  $x \in \nu$  is already in the first or in the last interval of the partition.

In the present form, our abstraction is not precise enough to capture the properties of interest of our case studies (Section 2). In particular the sequestration effect, which appears in the adaptor model, is not captured in the abstract semantics. Indeed, following Property 1.(4), it is always possible to increase the abstract level of the trimer  $ABC$  along a trace, whatever the initial concentration of  $B$ , until its level reaches its maximum value. Thus we cannot conclude from our abstract system that high levels of the adaptor protein  $B$  prevents the formation of  $ABC$  in the concrete one.

**Example 4.** *Figure 5 gives an illustration of the abstract transition system for the second case study (Section 2):*

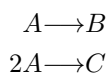

starting from any initial state  $q \in \mathcal{Q}_R$  such that  $\beta^\mathcal{Q}(q)$  satisfies the following constraints:

$$\begin{cases} \beta^\mathcal{Q}(q)(A) = 2, \\ \beta^\mathcal{Q}(q)(B) = 0, \\ \beta^\mathcal{Q}(q)(C) = 0. \end{cases}$$

Here we assume  $\delta > 2$  (which ensures that  $\delta > \max(M_\infty, (M + V)_\infty)$  and thus that Prop. 1.(4) applies) and  $p = 2$ . Again following Property 1.(4), it is always possible to increase the abstract level of  $B$  and  $C$  until they reach their maximum levels. Thus we cannot conclude from our abstract system that, in the concrete one, a competition between the production of  $B$  and the production  $C$  occurs depending on the initial concentration of  $A$ .

We will refine our abstraction in the next section in order to capture the properties of interest of our case studies.

## 5. Refinements

As we have noticed in Section 4, the abstraction  $\mathcal{T}_{\mathcal{Q}_{R,0}}^\sharp$  is very coarse. In particular, it does not exploit the following three kinds of situations. Firstly, the number of instances of chemical species may be entangled by some mass preservation invariants. Secondly, when the number of instances of a chemical species enters a new interval, it is sometimes possible to prove that there are not enough resources in the system to make this number reach the next interval. Thirdly, our concrete semantics is purely qualitative. We propose to add kinetic rates and abstract them accurately in order to account for the potential races between reactions.

In this section, we propose three refinements of the abstract semantics to formalise three corresponding classes of reasoning. These refinements are orthogonal: they can be combined by the means of a reduced product [15].

### 5.1. Mass invariants

#### 5.1.1. Inference

In the concrete semantics, the number of instances of the chemical species may be related by some mass conservation equations.

**Example 5.** Back to the example of Figure 3, the states composing the set of traces induced by the reaction network of the adaptor model and the initial state  $(2, 1, 2, 0, 0, 0)$  are:

$$\begin{aligned} &(2, 1, 2, 0, 0, 0), \\ &(1, 0, 2, 1, 0, 0), \\ &(2, 0, 1, 0, 1, 0), \\ &(1, 0, 1, 0, 0, 1). \end{aligned}$$

where each state  $q$  is denoted as the following sextuple:

$$(q(A), q(B), q(C), q(AB), q(BC), q(ABC)).$$

Thus, along this set of traces, the number of instances of  $A$ s remains constant equal to 2, that is to say that:

$$q(A) + q(AB) + q(ABC) = 2,$$

the number of instances of  $B$ s remains constant equal to 1, that is to say that:

$$q(B) + q(AB) + q(BC) + q(ABC) = 1,$$

and the number of instances of  $C$ s remains constant equal to 2, that is to say that:

$$q(C) + q(BC) + q(ABC) = 2.$$



In general, mass invariants are numerical constraints of the following form:

$$\sum \alpha_x q(x) = b$$

for  $(\alpha_x)_{x \in \nu} \in \mathbb{N}^\nu$  and  $b \in \mathbb{N}$  (i.e. semi-positive constraints).

Several solutions to obtain the semi-positive constraints that are satisfied in a network are available in the literature [19, 20, 21].

Without further information about the composition of chemical species, one solution consists in combining the vectors of a basis of the smallest affine space  $\text{affine\_hull}(R, \mathcal{Q}_{R,0})$  that contains all the states that are reachable in zero, one, or several computation steps (from one initial state in  $\mathcal{Q}_{R,0}$ ) in the reaction network  $R$ , in order to form constraints with non-negative coefficients only and remove the constraints in which negative coefficients cannot be eliminated. The affine hull  $\text{affine\_hull}(R, \mathcal{Q}_{R,0})$  is indeed the smallest affine set that contains the initial states and that is close with respect to each reaction vector, that is to say that:

$$\text{affine\_hull}\left(\left(\nu, (M_r, V_r)_{1 \leq r \leq n}\right), \mathcal{Q}_{R,0}\right) = \bigcap \left\{ E \subseteq \mathcal{Q}_R \left| \begin{array}{l} E \text{ is an affine set} \\ \mathcal{Q}_{R,0} \subseteq E \\ \forall \vec{u} \in E, \forall i \in \llbracket 1, n \rrbracket, \\ \vec{u} + V_i \in E \end{array} \right. \right\}.$$

**Example 6.** Keeping on with the example of Figure 3, we start with the affine set that contains the unique initial state. This set is defined as the solutions of the following set of affine equations:

$$\mathcal{S}_0 : \begin{cases} q(A) = 2, \\ q(B) = 1, \\ q(C) = 2, \\ q(AB) = 0, \\ q(BC) = 0, \\ q(ABC) = 0. \end{cases}$$

The solution of the set of equations  $\mathcal{S}_0$  is not close with respect to the reaction vector of the first reaction:

$$V'_1 : \begin{cases} A \mapsto -1, \\ B \mapsto -1, \\ C \mapsto 0, \\ AB \mapsto 1, \\ BC \mapsto 0, \\ ABC \mapsto 0. \end{cases}$$

The smallest affine set containing the solution of  $\mathcal{S}_0$  and that is close with respect to the vector  $V'_1$  is defined as the solutions of the following set of affine equations:

$$\mathcal{S}_1 : \begin{cases} q(A) + q(AB) = 2, \\ q(B) + q(AB) = 1, \\ q(C) = 2, \\ q(BC) = 0, \\ q(ABC) = 0. \end{cases}$$

The solution of the set of equations  $\mathcal{S}_1$  is not close with respect to the reaction vector of the second reaction:

$$V_2' : \begin{cases} A \mapsto 0, \\ B \mapsto -1, \\ C \mapsto -1, \\ AB \mapsto 0, \\ BC \mapsto 1, \\ ABC \mapsto 0. \end{cases}$$

The smallest affine set containing the solution of  $\mathcal{S}_1$  and that is close with respect to the vector  $V_2'$  is defined as the solutions of the following set of affine equations:

$$\mathcal{S}_2 : \begin{cases} q(A) + q(AB) = 2, \\ q(B) + q(AB) + q(BC) = 1, \\ q(C) + q(BC) = 2, \\ q(ABC) = 0. \end{cases}$$

The solution of the set of equations  $\mathcal{S}_2$  is not close with respect to the reaction vector of the third reaction:

$$V_3' : \begin{cases} A \mapsto 0, \\ B \mapsto 0, \\ C \mapsto -1, \\ AB \mapsto -1, \\ BC \mapsto 0, \\ ABC \mapsto 1. \end{cases}$$

The smallest affine set containing the solution of  $\mathcal{S}_2$  and that is close with respect to the vector  $V_3'$  is defined as the solutions of the following set of affine equations:

$$\mathcal{S}_3 : \begin{cases} q(A) + q(AB) + q(ABC) = 2, \\ q(B) + q(AB) + q(BC) + q(ABC) = 1, \\ q(C) + q(BC) + q(ABC) = 2, \end{cases}$$

The solution of the set of equations  $\mathcal{S}_3$  is close with respect to the reaction vector of the fourth reaction:

$$V_4' : \begin{cases} A \mapsto -1, \\ B \mapsto 0, \\ C \mapsto 0, \\ AB \mapsto 0, \\ BC \mapsto -1, \\ ABC \mapsto 1. \end{cases}$$

A basis for the smallest affine set that contains the initial state and that is close with respect to each reaction vector can be computed by using Gaussian

elimination at a time complexity  $O(n(m+n)^3)$  and at a memory complexity  $O(mn)$  [19] (where  $m$  denotes the number of chemical species, that is to say the cardinal of the set  $\nu$ , and  $n$  represents the number of reactions).

Getting a basis of the semi-positive invariants is more difficult, since there exist networks which possess an exponential number of minimal semi-positive invariants. A complete solution is proposed in [21]. In [20], a heuristics is used to drive the computation and get a subset of the semi-positive invariants at a time complexity  $O(n(m+n)^3)$  and a memory complexity  $O(mn)$ .

**Example 7.** *Keeping on with the example of Figure 3, we notice that the system  $S_3$  contains only non-negative coefficients. Thus it is already composed of semi-positive constraints.*

When the composition of chemical species is known, one can use them as a hint to discover quickly potential semi-positive invariants. Assume that we are given a set  $\mathcal{CU}$  of chemical units and a function *comp* mapping each chemical species  $x \in \nu$  into a multi-set  $\mathbb{N}^{\mathcal{CU}}$  of chemical units. Given a chemical species  $x \in \nu$  and a chemical unit  $cu \in \mathcal{CU}$ , we denote by  $comp(x)(cu)$  the number of occurrences of the chemical unit  $cu$  in the multi-set  $comp(x)$ , and we assume that this is actually the number of instances of the chemical unit  $cu$  in the chemical species  $x$ .

The overall number of a chemical unit  $cu \in \mathcal{CU}$  in a given state  $q \in \mathcal{Q}_R$ , can be expressed as the following linear combination:

$$\sum \{comp(x)(cu)q(x) \mid x \in \nu\}.$$

Moreover, this is a semi-positive invariant if and only if it is preserved by each reaction, that is to say, if for each  $i \in \llbracket 1, n \rrbracket$ , the following:

$$\sum \{comp(x)(cu)V(x) \mid x \in \nu\} = 0$$

is satisfied.

As a consequence, detecting which proteins are preserved by a set of reactions can be done at time complexity  $O(mm'n)$  (where  $m'$  denotes the number of chemical units, that is to say the cardinal of the set  $\mathcal{CU}$ ).

**Example 8.** *Keeping on with the example of Figure 3, we assume that chemical species are made of three kinds of proteins, A, B, and C, and that the composition of chemical species is given in tabular form as follows:*

	A	B	C
A	1	0	0
B	0	1	0
C	0	0	1
AB	1	1	0
BC	0	1	1
ABC	1	1	1

*Thus, in a given state  $q \in \mathcal{Q}_R$ , the overall number of instances of protein A is given by the following semi-positive linear form:*

$$q(A) + q(AB) + q(ABC);$$

the overall number of instances of protein  $B$  is given by the following semi-positive linear form:

$$q(B) + q(AB) + q(BC) + q(ABC);$$

and the overall number of instances of protein  $C$  is given by the following semi-positive linear form:

$$q(C) + q(BC) + q(ABC).$$

Moreover, each of these linear forms is orthogonal to each reaction vector of the reaction network, that is to say that the result of the application of any of these three linear forms to any of the four reaction vectors is equal to 0. Thus they induce semi-positive invariants for the system.

### 5.1.2. Analysis refinement

Mass preservation invariants are particular cases of trace invariants and can thus be used to refine our abstraction. Let  $inv \subseteq \mathcal{Q}_R \times T_R^*$  be a trace invariant. Formally, this means that:

$$\mathbb{F}_{\mathcal{Q}_{R,0}}(inv) \subseteq inv.$$

(see p.15 for a definition of the function  $\mathbb{F}_{\mathcal{Q}_{R,0}}$ ). By [16], the concrete semantics is the most precise of the trace invariants, that is to say that:

$$\mathcal{T}_{R,\mathcal{Q}_{R,0}} = \bigcap \{X \mid \mathbb{F}_{\mathcal{Q}_{R,0}}(X) \subseteq X\}.$$

In particular,  $\mathcal{T}_{R,\mathcal{Q}_{R,0}} \subseteq inv$ . It follows that:

$$lfp \mathbb{F}_{\mathcal{Q}_{R,0}} = lfp \mathbb{F}_{\mathcal{Q}_{R,0},inv}^{INV},$$

where the function  $\mathbb{F}_{\mathcal{Q}_{R,0},inv}^{INV}$  is defined as follows:

$$\mathbb{F}_{\mathcal{Q}_{R,0},inv}^{INV} : \begin{cases} \wp(\mathcal{Q}_R \times T_R^*) \rightarrow \wp(\mathcal{Q}_R \times T_R^*) \\ X \mapsto \mathbb{F}_{\mathcal{Q}_{R,0}}(X) \cap inv. \end{cases}$$

Here the function  $\mathbb{F}_{\mathcal{Q}_{R,0},inv}^{INV}$  maps any set of pretraces  $X \subseteq \mathcal{Q}_R \times T_R^*$  to the intersection between the set  $\mathbb{F}_{\mathcal{Q}_{R,0}}(X)$  and the trace invariant  $inv$ . The least fixpoints of both functions  $\mathbb{F}_{\mathcal{Q}_{R,0}}$  and  $\mathbb{F}_{\mathcal{Q}_{R,0},inv}^{INV}$  are equal, but the abstraction of the iterates of the latter may be more precise. Let  $\mathbb{F}_{\mathcal{Q}_{R,0},inv}^{INV\#}$  be the function that is defined as follows:

$$\mathbb{F}_{\mathcal{Q}_{R,0},inv}^{INV\#} : \begin{cases} \wp(\mathcal{Q}_R^\# \times T_{R/\varepsilon}^{\#\star}) \rightarrow \wp(\mathcal{Q}_R^\# \times T_{R/\varepsilon}^{\#\star}) \\ Y \mapsto \alpha^{\mathcal{T}} \left( \mathbb{F}_{\mathcal{Q}_{R,0},inv}^{INV}(\gamma^{\mathcal{T}}) \right). \end{cases}$$

(see p.19 for a definition of the Galois connection  $(\alpha^{\mathcal{T}}, \gamma^{\mathcal{T}})$ ). The function  $\alpha^{\mathcal{T}}$  is  $\cap$ -complete, so the function  $\mathbb{F}_{\mathcal{Q}_{R,0},inv}^{INV\#}$  is equal to:

$$[Y \mapsto \mathbb{F}_{\mathcal{Q}_{R,0}}^\#(Y) \cap \alpha^{\mathcal{T}}(inv)].$$

The iterates of the function  $\mathbb{F}_{\mathcal{Q}_{R,0},inv}^{INV\#}$  provide another effective way, more precise but still sound, to abstract the trace semantics:

**Theorem 2 (abstract trace semantics with invariants).** *Let  $\mathcal{Q}'_{R,0}$  be a subset of  $\mathcal{Q}_{R,0}$  and  $inv$  be a part of  $\mathcal{T}_{R,\mathcal{Q}_{R,0}}$  such that  $\mathbb{F}_{\mathcal{Q}'_{R,0}}(inv) \subseteq inv$ .*

*Then, we have:*

$$\mathcal{T}_{R,\mathcal{Q}'_{R,0}} \subseteq \gamma^{\mathcal{T}}(\text{Ifp}[Y \mapsto \mathbb{F}_{\mathcal{Q}'_{R,0}}^{\sharp}(Y) \cap \alpha^{\mathcal{T}}(inv)]).$$

In Theorem 2, we have partitioned the traces to separate the computation of their abstraction according to their initial states (for more details about trace partitioning, see [22, 23]). This leads to a more accurate abstraction whenever some pairs of initial states do not share the same invariants.

When the trace invariant is a set of semi-positive constraints, the following property gives an explicit definition for the term  $\alpha^{\mathcal{T}}(inv)$ .

**Property 2 (mass invariant separation).** *Let:*

- $(a_x)_{x \in \nu} \in \mathbb{N}^{\nu} \setminus \{0\}^{\nu}$  be a family of positive integer coefficients (with at least one not equal to 0),
- $b \in \mathbb{N}$  be a non-negative integer coefficient,
- $S$  be the sum of the coefficients  $a_x$  for all chemical species  $x \in \nu$  (i.e.  $S = \sum_{x \in \nu} a_x$ ),
- for any abstract state  $q^{\sharp}$ ,  $q_{max}^{\sharp}$  be the maximum element of the following set:

$$\{k \in \llbracket 0, p \rrbracket \mid \exists x \in \nu, a_x > 0 \wedge k = q^{\sharp}(x)\}.$$

*If  $b \geq S\delta^{\beta^{\mathbb{R}}(b)}$ , the following set:*

$$\alpha^{\mathcal{Q}} \left( \left\{ q \in \mathcal{Q}_R \mid b = \sum_{x \in \nu} a_x q(x) \right\} \right)$$

*is equal to the following set:*

$$\{q^{\sharp} \in \mathcal{Q}_R^{\sharp} \mid q_{max}^{\sharp} = \beta^{\mathbb{R}}(b)\}.$$

*Otherwise, it is a subset of the following set:*

$$\left\{ q^{\sharp} \in \mathcal{Q}_R^{\sharp} \mid \beta^{\mathbb{R}}(b) - \left\lceil \frac{S}{\delta} \right\rceil \leq q_{max}^{\sharp} \leq \beta^{\mathbb{R}}(b) \right\}.$$

Proof of Property 2 is given in Appendix A.2.

Property 2 has a flavour of tropical algebrae [5]. In particular, whenever the affine constants of mass preservation invariants are far enough from the lower bound of their sampling interval, the abstraction of the number of instances of a protein is equal to the abstraction of the number of instances of the most abundant chemical species containing this protein. Otherwise, if the parameter  $\delta$  is chosen great enough (that is to say that  $\delta \geq S$ ), Property 2 still ensures that the abstraction of the number of instances of a protein is either the same as the abstraction of the number of instances of the most abundant chemical species containing this protein, or the next one.

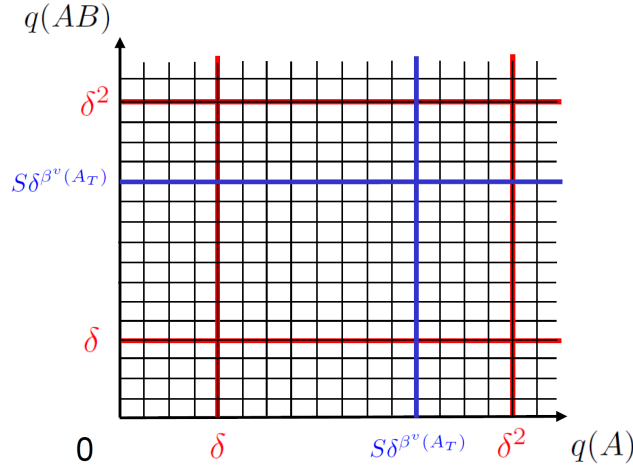

Figure 13: Illustration of mass invariant separation on the case study of the adaptor model, taking as mass invariant the preservation of the overall number of As:  $q(A) + q(AB) + q(ABC) = A_T$ . We assume  $\delta = 4$  and  $\beta^v(A_T) = 1$  (i.e.  $4 \leq A_T < 16$ ). Blue lines denote the threshold  $S\delta^{\beta^v(A_T)} = 12$ . If  $A_T \geq 12$ , the abstraction of the mass invariant is the set of states  $q^\sharp$  such that  $\max(q^\sharp(A), q^\sharp(AB), q^\sharp(ABC)) = 1$ . Otherwise it is the set of states  $q^\sharp$  such that  $\max(q^\sharp(A), q^\sharp(AB), q^\sharp(ABC)) \in \{0, 1\}$  (Prop. 2).

**Example 9.** Figure 13 shows an illustration of the application of Property 2 on the case study of the adaptor model, taking as mass invariant the preservation of the overall number of As:

$$q(A) + q(AB) + q(ABC) = A_T.$$

We assume that  $\delta = 4$  and  $\beta^v(A_T) = 1$  (i.e. the affine constant  $A_T$  belongs to the sampling interval  $\llbracket \delta, \delta^2 \rrbracket$ ). The sum of the coefficients of the mass equation is  $S = 3$ . Thus we have  $\delta > S$  and  $S\delta^{\beta^v(A_T)} = 12$  (depicted by the blue lines in Fig. 13).

Therefore, following Property 2, if  $A_T \geq 12$ , the abstraction of the mass invariant is the set of states  $q^\sharp$  such that:

$$\max(q^\sharp(A), q^\sharp(AB), q^\sharp(ABC)) = 1.$$

Otherwise it is the set of states  $q^\sharp$  such that:

$$\max(q^\sharp(A), q^\sharp(AB), q^\sharp(ABC)) \in \{0, 1\}.$$

**Example 10.** Figure 6 gives an illustration of the induced set of abstract transitions for the case study of the model showing a race between a unary and a binary reaction:

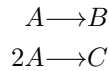

refined with the following mass invariant:

$$q(A) + q(B) + 2q(C) = A_T$$

and starting from the same initial state as in Figure 5, i.e. starting from any initial state  $q \in \mathcal{Q}_R$  such that  $\beta^{\mathcal{Q}}(q)$  satisfies the following constraints:

$$\beta^{\mathcal{Q}}(q) : \begin{cases} A \mapsto 2, \\ B \mapsto 0, \\ C \mapsto 0. \end{cases}$$

Here we assume that  $p = 2$ ,  $\delta > 4$  and that the affine constant  $A_T$  is far from the lower bound of its sampling interval ( $A_T = 4\delta^2$ ). Following Property 2, the abstraction of the mass invariant is thus the set of states  $q^\sharp$  such that:

$$\max(q^\sharp(A), q^\sharp(B), q^\sharp(C)) = 2$$

(depicted by the black nodes in Fig. 6). By soundness of the abstraction (Thm. 2), we can thus conclude from our abstract semantics that, in the concrete one, the number of instances of  $A$  will not decrease below  $\delta^2$  before either the number of instances of  $B$  or the number of instances of  $C$  exceeds  $\delta^2$ .

## 5.2. Watching interval boundaries

So far, we have approximated the number of instances of each chemical species by means of intervals. This is a quite coarse abstraction. Indeed, when the number of instances of a chemical species enters a new interval, there is not enough information in our abstraction to reason about whether or not there may be enough resources in the system so that it may reach and enter the next interval. For instance, in the case study of the model with the adaptor, when the system is in a state  $q \in \mathcal{Q}_R$  such that  $\beta^{\mathcal{Q}}(q)(A)$ ,  $\beta^{\mathcal{Q}}(q)(C)$  and  $\beta^{\mathcal{Q}}(q)(ABC)$  are all equal to 0, it may be possible to reach a state  $q'$  such that  $\beta^{\mathcal{Q}}(q')(ABC) = 1$ , because, on the first hand, the number of instances of  $ABC$ s may be close to  $\delta$  and, on the second hand, there may be enough instances of  $A$  so as to produce enough instances of  $ABC$  in order to cross this threshold. But, after having reached this concentration level, there will be not enough instances of  $A$  to reach a state  $q''$  such that  $\beta^{\mathcal{Q}}(q'')(ABC) > 1$ .

**Example 11.** Figure 7 gives an illustration of this reasoning on the case study of the adaptor model:

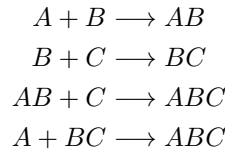

We assume  $\delta = 3$  and start from the initial state  $q_0$  that is defined as follows:

$$q_0 : \begin{cases} A \mapsto 2, \\ B \mapsto 0, \\ C \mapsto 2, \\ AB \mapsto 2, \\ BC \mapsto 0, \\ ABC \mapsto 2. \end{cases}$$

(depicted in Fig. 7(a)), for which the number of instances of  $ABC$  is close to the lower border of its next sampling interval (i.e.  $\delta$ ). The fourth reaction can then occur leading to the production of one instance of  $ABC$  and its entrance into a new sampling interval upwards (i.e.  $\llbracket \delta, \delta^2 \rrbracket$ ). The system is then in the state  $q_1$  that is defined as follows:

$$q_1 : \begin{cases} A & \mapsto 2, \\ B & \mapsto 0, \\ C & \mapsto 1, \\ AB & \mapsto 1, \\ BC & \mapsto 0, \\ ABC & \mapsto 3. \end{cases}$$

(see Fig. 7(b)). However, after that, at most 1 instance of  $ABC$  can be further produced (from the occurrence of the fourth reaction), below the number of instances required for  $ABC$  to reach the next sampling interval upwards (i.e. 6).

We formalise this kind of reasoning and refine our abstraction accordingly.

We focus on proving that the number of instances of some chemical species cannot cross their current interval upwards (the dual case can be dealt with the same way). We assume that  $\delta > 2V_\infty$ . Given a state  $q \in \mathcal{Q}_R$  and a chemical species  $x \in \nu$ , we write  $q \models x_\dagger$  :

- if either the value  $q(x)$  is in the interval  $\llbracket \delta^{\beta^{\mathbb{R}}(q(x))}, \delta^{\beta^{\mathbb{R}}(q(x))} + V_\infty \rrbracket$
- or if there is no concrete trace  $\tau$  in  $\mathcal{T}_{R, \mathcal{Q}_R}$  such that:

- (1)  $first(\tau) = q$ ;
- (2) and  $\beta^{\mathbb{R}}(final(\tau)(x)) > \beta^{\mathbb{R}}(q(x))$ .

We denote by  $\mathcal{C}_\dagger$  the set  $\{x_\dagger \mid x \in \nu\}$ .

We update the definitions of abstract states and abstract traces to take into account the constraints in  $\mathcal{C}_\dagger$ . Formally, an abstract state is now an element of  $\mathcal{Q}_R^\sharp \times \wp(\mathcal{C}_\dagger)$ . The first component encodes the intervals for the number of instances of chemical species, whereas the second component is a set of constraints that specifies which chemical species may eventually cross their current intervals upwards. We also define a refined abstraction function  $\beta_\dagger^{\mathcal{Q}}$  by:

$$\beta_\dagger^{\mathcal{Q}}(q) \triangleq (\beta^{\mathcal{Q}}(q), \{c \in \mathcal{C}_\dagger \mid q \models c\}).$$

We denote by  $\beta_\dagger^{\mathcal{T}}$  the function mapping each concrete trace  $\tau \in \mathcal{T}_{R, \mathcal{Q}_{R,0}}$  to the trace obtained by firstly replacing in the trace  $\tau$  every state  $q$  with its abstraction  $\beta_\dagger^{\mathcal{Q}}(q)$  and by secondly removing silent moves. The Galois connection induced by  $\beta_\dagger^{\mathcal{Q}}$  (resp.  $\beta_\dagger^{\mathcal{T}}$ ) is denoted as  $(\alpha_\dagger^{\mathcal{Q}}, \gamma_\dagger^{\mathcal{Q}})$  (resp.  $(\alpha_\dagger^{\mathcal{T}}, \gamma_\dagger^{\mathcal{T}})$ ).

Iterating the most precise counterpart  $\alpha_\dagger^{\mathcal{T}} \circ \mathbb{F}_{\mathcal{Q}_{R,0}} \circ \gamma_\dagger^{\mathcal{T}}$  to the function  $\mathbb{F}_{\mathcal{Q}_{R,0}}$  would be very costly. Thus we iterate an over-approximation of it instead. We define  $esc$  as the set of the triples  $(q^\sharp, x_\dagger, r) \in \mathcal{Q}_R^\sharp \times \mathcal{C}_\dagger \times \llbracket 1, n \rrbracket$  such that there is a concrete trace  $\tau \in \mathcal{T}_{R, \mathcal{Q}_R}$  which satisfies:



- (i)  $\beta^{\mathcal{Q}}(\text{first}(\tau)) = q^{\sharp}$ ,
- (ii)  $\text{first}(\tau) \models x_{\dagger}$ ,
- (iii)  $\beta^{\mathcal{Q}}(\text{first}(\tau))(x) < \beta^{\mathcal{Q}}(\text{final}(\tau))(x)$ ,
- (iv)  $V_r(x) > 0$ ,
- (v) there exists a transition in  $\tau$  with the label  $r$ .

Intuitively, the set  $\text{esc}$  contains all the triples  $(q^{\sharp}, x_{\dagger}, r)$  such that, whenever the system is in a state  $q \in \gamma^{\mathcal{Q}}(\{q^{\sharp}\})$  satisfying  $q \models x_{\dagger}$ , the number of instances of the chemical species  $x$  may eventually cross the upper bound of its current interval, in a trace that contains at least one application of the rule indexed by the integer  $r$ .

So as to offer a choice of trade-off between accuracy and efficiency, we introduce a superset  $\text{esc}^{\sharp}$  of  $\text{esc}$ , considered as a parameter of our abstraction. Intuitively, whenever a triple  $(q^{\sharp}, x_{\dagger}, r) \in \text{esc}^{\sharp}$ , it means that our approximation has failed in proving that the number of instances of the species  $x$  will never cross its current interval upwards.

We can now refine the set of the transitions  $T_R^{\sharp}$  of the abstract semantics (see p.17 for a definition of  $T_R^{\sharp}$ ).

**Definition 7 (abstract transitions).** We denote by  $T_{\text{esc}^{\sharp}}^{\text{CROSS}^{\sharp}}$  the set of the triples  $((q^{\sharp}, C), r, (q^{\sharp'}, C'))$  in  $(\mathcal{Q}_R^{\sharp} \times \wp(\mathcal{C}_{\dagger})) \times \llbracket 1, n \rrbracket \times (\mathcal{Q}_R^{\sharp} \times \wp(\mathcal{C}_{\dagger}))$  such that:

- (i) either the following three conditions:

- (a)  $(q^{\sharp}, r, q^{\sharp'}) \in T_R^{\sharp}$ ,
- (b)  $\forall x_{\dagger} \in C, q^{\sharp'}(x) \leq q^{\sharp}(x)$ , and
- (c)  $C' = \{C \cup \{x_{\dagger} \in \mathcal{C}_{\dagger} \mid q^{\sharp'}(x) > q^{\sharp}(x)\}\} \setminus \{x_{\dagger} \in \mathcal{C}_{\dagger} \mid q^{\sharp'}(x) < q^{\sharp}(x)\}$

are satisfied;

- (ii) or the following two conditions:

- (a)  $q^{\sharp'} = q^{\sharp}$ , and
- (b) there exists a constraint  $c \in \mathcal{C}_{\dagger}$  such that:

$$C' = C \setminus \{c\} \text{ and } (q^{\sharp}, c, r) \in \text{esc}^{\sharp}$$

are satisfied.

We distinguish between two kinds of transitions in Definition 7. The first ones consist in regular computation steps: they apply reactions that are allowed and do not violate the constraints about the capability of the chemical species to cross their intervals. After such reactions, the set of the chemical species that have just entered a new interval from below (resp. above) is recorded in (resp. removed from) the set of the constraints. The second kind of transitions consists in removing a constraint where we are unable to prove that the corresponding chemical species will never cross its current interval upwards.

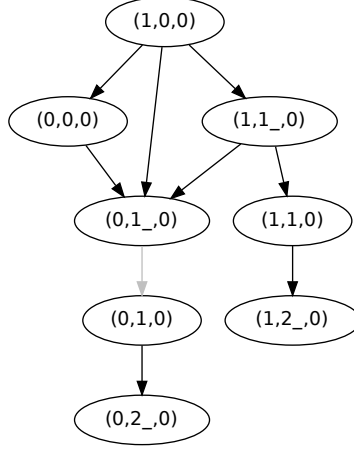
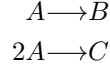

Figure 14: Set of abstract transitions for the case study of the race between a unary and a binary reaction refined with the constraint on the upwards crossing interval, starting from the initial state  $((q^\sharp(A) = 1, q^\sharp(B) = 0, q^\sharp(C) = 0), \emptyset)$ , for which none of the chemical species is annotated, and considering only the transitions triggered by the unary reaction. We assume that  $p = 2$ ,  $\delta > 4$  and  $esc^\sharp = esc$ . A node represents a refined abstract state while an arrow denotes a transition (regular or not) resulting from the application of the unary reaction. Annotations of chemical species of states are denoted by the subscript character “\_”. The grey arrow represents a transition which is discarded by the refinement.

**Example 12.** Figure 14 illustrates Definition 7, on the case study of the race between a unary and a binary reaction (Sect. 2):



For sake of clarity we consider only the transitions triggered by the unary reaction and start from an arbitrary state  $q$  such that  $\beta^{\mathcal{Q}}(q)$  satisfies the following constraints:

$$\beta^{\mathcal{Q}}(q) : \begin{cases} A \mapsto 1, \\ B \mapsto 0, \\ C \mapsto 0. \end{cases}$$

and such that none of the chemical species is annotated, that is to say:

$$\{c \in \mathcal{C}_\dagger \mid q \models c\} = \emptyset.$$

We assume that  $\delta > 4$  and set the parameter of our refinement  $esc^\sharp = esc$ .

At the initial state,  $B$  is not annotated. Therefore its abstract level can be updated giving rise to the following transitions:

$$\left( \left( \begin{array}{l} A \mapsto 1 \\ B \mapsto 0 \\ C \mapsto 0 \end{array}, \emptyset \right) \xrightarrow{1} \left( \begin{array}{l} A \mapsto 1 \\ B \mapsto 1 \\ C \mapsto 0 \end{array}, \{B_\dagger\} \right) \right),$$

and

$$\left( \left( \begin{array}{l} A \mapsto 1 \\ B \mapsto 0 \\ C \mapsto 0 \end{array} , \emptyset \right) \xrightarrow{1} \left( \begin{array}{l} A \mapsto 0 \\ B \mapsto 1 \\ C \mapsto 0 \end{array} , \{B_{\dagger}\} \right) ,$$

for which the set of chemical species that have just entered a new interval (i.e.  $B$ ) is recorded in the set of annotations of the state (here a transition  $((q^{\sharp}, C), r, (q^{\sharp'}, C'))$  is denoted by  $(q^{\sharp}, C) \xrightarrow{r} (q^{\sharp'}, C')$  ).

We then wonder whether the triples:

$$\left( \begin{array}{l} A \mapsto 1 \\ B \mapsto 1 \\ C \mapsto 0 \end{array} , B_{\dagger}, 1 \right) ,$$

and

$$\left( \begin{array}{l} A \mapsto 0 \\ B \mapsto 1 \\ C \mapsto 0 \end{array} , B_{\dagger}, 1 \right) ,$$

belong to the set  $esc^{\sharp}$ .

In both cases,  $B$  is annotated. Therefore, while the system is in any of these two abstract states, we know that either there exists no trace starting from the current state such that the number of instances  $B$  reaches  $\delta^2$ , either the number of instances of  $B$  in the current state ranges in the interval  $\llbracket \delta, \delta + 2 \rrbracket$ , or both. Thus, in order to prove that the number of instances of  $B$  will not reach  $\delta^2$  once the system is in one these abstract states, it is enough to prove that if the number of instance of  $B$  is less than  $\delta + 2$  in the current state, then this number will never reach  $\delta^2$ .

- (1) Considering the first triple, the number of instances of  $A$  ranges in the interval  $\llbracket \delta, \delta^2 \rrbracket$ . There exists a trace in the concrete system that contains at least one application of the unary reaction in which the number of instances of  $B$  crosses the upper bound of its current interval (i.e.  $\delta^2$ ), for instance the trace  $\tau$  such that:

- (a)  $first(\tau)(A) = \delta^2 - 1$  and  $first(\tau)(B) = \delta$ ;
- (b)  $\tau$  is composed of a sequence of  $(\delta^2 - \delta)$  occurrences of the unary reaction.

Therefore, the first triple belongs to  $esc^{\sharp}$ .  $B$  can then loose its annotation, giving rise to the following trace:

$$\left( \left( \begin{array}{l} A \mapsto 1 \\ B \mapsto 1 \\ C \mapsto 0 \end{array} , \{B_{\dagger}\} \right) \xrightarrow{1} \left( \begin{array}{l} A \mapsto 1 \\ B \mapsto 1 \\ C \mapsto 0 \end{array} , \emptyset \right) \xrightarrow{1} \left( \begin{array}{l} A \mapsto 1 \\ B \mapsto 2 \\ C \mapsto 0 \end{array} , \{B_{\dagger}\} \right) .$$

- (2) Considering the second triple, the number of instances of  $A$  now belongs to the interval  $\llbracket 0, \delta \rrbracket$ . In this case, there exists no trace in which the number of instances of  $B$  crosses the upper bound  $\delta^2$  of its current interval. Indeed, the number of instances of  $B$  which would have at least to be produced is:

$$\delta^2 - (\delta + 2),$$

which is above the maximum number of instances of  $A$  available:

$$\delta - 1.$$

Therefore, the second triple does not belong to  $esc^\sharp$ .

Let  $\mathcal{T}_{esc^\sharp}^{\text{CROSS}^\sharp}$  be the set of pretraces of elements of  $\mathcal{Q}_R^\sharp \times \wp(\mathcal{C}_\dagger)$  and transitions in  $T_{esc^\sharp}^{\text{CROSS}^\sharp}$ . Given a set of initial states  $\mathcal{Q}_{R,0} \subseteq \mathcal{Q}_R$ , we consider the function  $\mathbb{F}_{\mathcal{Q}_{R,0}, esc^\sharp}^{\text{CROSS}^\sharp}$  over the set  $\wp(\mathcal{T}_{esc^\sharp}^{\text{CROSS}^\sharp})$  mapping each subset  $Y$  of  $\mathcal{T}_{esc^\sharp}^{\text{CROSS}^\sharp}$  to the subset:

$$\alpha_\dagger^\mathcal{Q}(\mathcal{Q}_{R,0}) \cup \left\{ \tau^\sharp \frown (q^\sharp, r, q^{\sharp'}) \mid \begin{array}{l} \tau^\sharp \in Y \\ \wedge (q^\sharp, r, q^{\sharp'}) \in T_{esc^\sharp}^{\text{CROSS}^\sharp} \\ \wedge \text{final}(\tau^\sharp) = q^\sharp \end{array} \right\}.$$

The function  $\mathbb{F}_{\mathcal{Q}_{R,0}, esc^\sharp}^{\text{CROSS}^\sharp}$  is monotonic and satisfies:

$$[\alpha_\dagger^\mathcal{T} \circ \mathbb{F}_{\mathcal{Q}_{R,0}} \circ \gamma_\dagger^\mathcal{T}](Y) \subseteq \mathbb{F}_{\mathcal{Q}_{R,0}, esc^\sharp}^{\text{CROSS}^\sharp}(Y)$$

for any subset  $Y$  of  $\mathcal{T}_{esc^\sharp}^{\text{CROSS}^\sharp}$  (see p.15 for a definition of the function  $\mathbb{F}_{\mathcal{Q}_{R,0}}$  and p.19 for a definition of the Galois connection  $(\alpha^\mathcal{T}, \gamma^\mathcal{T})$ ). By [15], it follows that our approach is sound:

**Theorem 3 (soundness).** *The function  $\mathbb{F}_{\mathcal{Q}_{R,0}, esc^\sharp}^{\text{CROSS}^\sharp}$  has a least fixpoint.*

Moreover, we have:

$$\text{lfp } \mathbb{F}_{\mathcal{Q}_{R,0}} \subseteq \gamma_\dagger^\mathcal{T}(\text{lfp } \mathbb{F}_{\mathcal{Q}_{R,0}, esc^\sharp}^{\text{CROSS}^\sharp}).$$

**Example 13.** *Back to our example of Figure 14, the following transition:*

$$\left( \begin{array}{l} A \mapsto 0 \\ B \mapsto 1, \{B_\dagger\} \\ C \mapsto 0 \end{array} \right) \xrightarrow{1} \left( \begin{array}{l} A \mapsto 0 \\ B \mapsto 1, \emptyset \\ C \mapsto 0 \end{array} \right)$$

does not belong to the set of abstract transitions. Therefore, by soundness of the abstraction (Thm. 3), we can prove from the induced abstract semantics that, in the concrete one, whenever the system is at a state  $q$  such that the abstract state  $\beta^\mathcal{Q}(q)$  is defined by the following constraints:

$$\beta^\mathcal{Q}(q) : \begin{cases} A \mapsto 0, \\ B \mapsto 1, \\ C \mapsto 0, \end{cases}$$

and such that  $q(B)$  is in the interval  $[[\delta, \delta + 2]]$ , the number of instances of  $B$  will never exceed  $\delta^2$  in a trace containing at least one application of the unary reaction.

The following property proposes a trade-off for the definition of the primitive  $esc^\sharp$  (as defined p.32), based on a linear integer decision procedure.

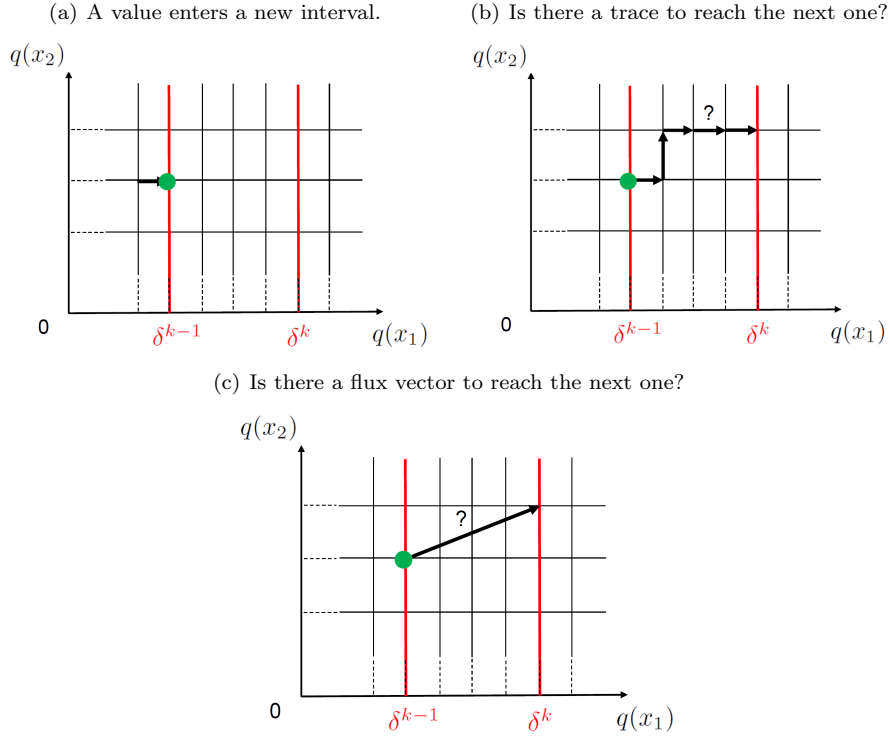

Figure 15: Schematic illustration of the formalisation of the constraint on limiting resources for interval crossing. The chemical species  $x_1$ , which number of instances has just entered a new sampling interval upwards, is annotated (here depicted by the green colour)(Fig. 15(a)). Then we wonder whether we can prove that the number of instances of the annotated chemical species cannot escape its current interval upwards in a trace containing at least one application of a given reaction (Fig. 15(b)). Since this question is difficult to answer we replace it by an overapproximation which forgets about the order of the transitions composing a trace (Fig. 15(c)). This problem is solved using the linear decision procedure described in Property 3.

**Property 3 (Decision procedure).** Let  $(q^\sharp, x_\dagger, r) \in \text{esc}$ . We have  $q^\sharp(x) \neq p$  and there exists a function  $w \in \mathbb{N}^{\llbracket 1, n \rrbracket}$  such that:

- (i)  $w(r) > 0$ ,
- (ii)  $\delta^{q^\sharp(x)} + V_\infty + V_w(x) \geq \delta^{q^\sharp(x)+1}$ ,
- (iii)  $\forall x' \in \nu, q^\sharp(x') \neq p \Rightarrow \delta^{q^\sharp(x')+1} + V_w(x') > 0$ ,

where, for any chemical species  $x' \in \nu$ ,  $V_w(x')$  denotes the value of the expression  $\sum_{1 \leq r' \leq n} w(r')V_{r'}(x')$ .

Proof of Property 3 is given in Appendix A.3.

In Property 3, we abstract away the order of the transitions composing a trace and focus on proving whether there exists no flux vector  $w$  containing at least one occurrence of a given reaction  $r$  which allows a given annotated chemical species  $x_\dagger$  to escape its current sampling interval  $\gamma^{\mathcal{Q}}(q^\sharp)$  upwards (Fig. 15). Whenever an annotated chemical species  $x_\dagger$  can escape its sampling interval  $\gamma^{\mathcal{Q}}(q^\sharp)$ , the following conditions are necessarily satisfied:

- enough instances of the chemical species  $x$  are produced along the flux vector  $w$  for the number of instances of  $x$  to escape its current sampling interval upwards (condition (ii));
- there are enough reactant resources available for the number of instances of  $x$  to escape its current sampling interval upwards along the flux vector  $w$  (condition (iii)).

We conclude this subsection by describing which transitions can be discarded thanks to our refinement of the abstraction in the second case study.

**Example 14.** *Figure 14 shows the set of abstract transitions refined with our reasoning on the constraints on interval crossing, for the case study of the race between a unary and a binary reaction (Sect. 2).*

### 5.3. Scale separation

In the case study of the model with the adaptor, when there are a lot of  $B$ s and only a few  $BC$ s in the system, so as to capture the sequestration effect properly, we have to neglect the binding reaction between the chemical species  $A$  and  $BC$ . In other words, we have to exploit the separation between different time scales.

Several methods can be used for the formalisation of the separation between time scales. These methods are not necessarily compatible. They have to be selected according to the modelling paradigm. First of all, a quantity (which may be a flux, a rate, a propensity,...) has to be associated to each reaction. Then one option consists in interpreting this quantity as a priority level for each reaction, and in bounding the number of occurrences of lower priority reactions with respect to the number of occurrences of higher priority reactions, in each sequence of consecutive transitions. This comes down to add supplementary numerical constraints to the integer programming problem introduced in Sec. 5.2 to take into account the fact that there might not be enough resources for the number of instances of a given chemical species to reach the upper bound of its sampling interval. More precisely, we have to refine the numerical constraints so as to take into account the fact that the ratio between the frequency of application of the low priority reactions and the frequency of the application of the high priority ones shall remain bounded by a user-defined parameter. At the limit, we can assume that higher priority level reactions entirely preempt lower priority level ones. This assumption was previously used in the context of logical modelling [13].

Other options can be considered. Stochastic semantics can be introduced to sort out the competition between reactions. At each state of the system, they define the probability distribution for the next reaction, as well as a probability distribution for when this reaction will occur. At the thermodynamic limit, we get the ordinary differential equations (ODE) semantics, which describes the mean behaviour of the model at high concentrations. Tropical approaches can then be used to simplify the ODE semantics applying time scale separation constraints [5], where special care is taken not to neglect the reactions which are involved in large time relaxations of fast cycles.

In this section, we propose:

- (1) a generic method to formalise assumptions about time scale separation;
- (2) a systematic way to lift these assumptions to the abstract semantics.

Here, we focus on the assumption which has been proposed to model time scale separation in logical modelling. Yet other assumptions could be considered and abstracted following the same systematic approach.

We start from a given scheduler  $\mathcal{S}$ . Formally, a scheduler  $\mathcal{S}$  is a function between the set  $\mathcal{Q}_R \times T_R^*$  and the powerset  $\wp(\llbracket 1, n \rrbracket)$ :

$$\mathcal{S} : \mathcal{Q}_R \times T_R^* \longrightarrow \wp(\llbracket 1, n \rrbracket).$$

Intuitively, the scheduler restricts the set of the reactions that can be computed immediately after a (pre)trace. We refine the concrete semantics accordingly: we define  $\mathcal{T}_{\mathcal{R}, \mathcal{Q}_{R,0}, \mathcal{S}}^{\text{TIME}}$  as the least fixpoint of the monotonic function  $\mathbb{F}_{\mathcal{Q}_{R,0}, \mathcal{S}}^{\text{TIME}}$ , defined as follows:

$$\mathbb{F}_{\mathcal{Q}_{R,0}, \mathcal{S}}^{\text{TIME}} : \left\{ \begin{array}{l} \wp(\mathcal{Q}_R \times T_R^*) \rightarrow \wp(\mathcal{Q}_R \times T_R^*) \\ X \mapsto \mathcal{Q}_{R,0} \cup \left\{ \tau \frown (q, r, q') \mid \begin{array}{l} \tau \frown (q, r, q') \in \mathbb{F}_{\mathcal{Q}_{R,0}}(X) \\ \wedge r \in \mathcal{S}(\tau) \end{array} \right\} \end{array} \right\}.$$

Roughly speaking, the function  $\mathbb{F}_{\mathcal{Q}_{R,0}, \mathcal{S}}^{\text{TIME}}$  maps any set of pretraces  $X$  to the set of pretraces that can be obtained by continuing a pretrace in the set  $X$  with a transition belonging to the set  $\mathbb{F}_{\mathcal{Q}_{R,0}}(X)$  and whose reaction is in the set  $\mathcal{S}(\tau)$ .

Now we lift the action of the scheduler  $\mathcal{S}$  to the abstract semantics. For this end, we introduce, as a parameter of our analysis, a function  $\mathcal{S}^\sharp$  between the set  $\mathcal{Q}_R^\sharp \times T_{R/\varepsilon}^{\sharp*}$  and  $\wp(\llbracket 1, n \rrbracket)$ :

$$\mathcal{S}^\sharp : \mathcal{Q}_R^\sharp \times T_{R/\varepsilon}^{\sharp*} \longrightarrow \wp(\llbracket 1, n \rrbracket)$$

such that, for any concrete trace  $\tau \in \mathcal{T}_{\mathcal{R}, \mathcal{Q}_{R,0}, \mathcal{S}}^{\text{TIME}}$  and any transition  $(q, r, q') \in T_R$  that satisfy:

- (i)  $\text{final}(\tau) = q$ ,
- (ii)  $\beta^{\mathcal{Q}}(q) \neq \beta^{\mathcal{Q}}(q')$ , and
- (iii)  $r \in \mathcal{S}(\tau)$ ,

we have:

$$r \in \mathcal{S}^\sharp(\beta^{\mathcal{T}}(\tau)).$$

Intuitively, a reaction  $r$  is in the set  $\mathcal{S}^\sharp(\tau^\sharp)$  whenever our approximation fails in proving that no trace  $\tau \in \gamma^{\mathcal{T}}(\tau^\sharp)$  can be continued by applying the reaction  $r$  while changing the sampling interval of at least one chemical species.

Then we use the function  $\mathcal{S}^\sharp$  to define a sound counterpart  $\mathbb{F}_{\mathcal{Q}_{R,0}, \mathcal{S}^\sharp}^{\text{TIME}^\sharp}$  to the function  $\mathbb{F}_{\mathcal{Q}_{R,0}, \mathcal{S}}^{\text{TIME}}$  as follows:

$$\left\{ \begin{array}{l} \wp(\mathcal{Q}_R^\sharp \times T_{R/\varepsilon}^{\sharp*}) \rightarrow \wp(\mathcal{Q}_R^\sharp \times T_{R/\varepsilon}^{\sharp*}) \\ Y \mapsto \alpha^{\mathcal{Q}}(\mathcal{Q}_{R,0}) \cup \left\{ \tau^\sharp \frown (q^\sharp, r, q^{\sharp'}) \mid \begin{array}{l} \tau^\sharp \frown (q^\sharp, r, q^{\sharp'}) \in \mathbb{F}_{\mathcal{Q}_{R,0}}^\sharp(Y) \\ \wedge r \in \mathcal{S}^\sharp(\tau^\sharp) \end{array} \right\} \end{array} \right\}.$$

The function  $\mathbb{F}_{\mathcal{Q}_{R,0}, \mathcal{S}^\sharp}^{\text{TIME}^\sharp}$  is monotonic and satisfies:

$$[\alpha^{\mathcal{T}} \circ \mathbb{F}_{\mathcal{Q}_{R,0}, \mathcal{S}}^{\text{TIME}} \circ \gamma^{\mathcal{T}}](Y) \subseteq \mathbb{F}_{\mathcal{Q}_{R,0}, \mathcal{S}^\sharp}^{\text{TIME}^\sharp}(Y),$$

for any subset  $Y \subseteq \mathcal{Q}_R^\sharp \times T_{R/\varepsilon}^{\sharp*}$ . By [15], we can conclude that our approach is sound, as stated in the following theorem:

**Theorem 4 (soundness).** *The function  $\mathbb{F}_{\mathcal{Q}_{R,0},\mathcal{S}^\sharp}^{\text{TIME}^\sharp}$  has a least fixpoint.*

*Moreover, we have:*

$$\text{lfp } \mathbb{F}_{\mathcal{Q}_{R,0},\mathcal{S}}^{\text{TIME}} \subseteq \gamma^{\mathcal{T}}(\text{lfp } \mathbb{F}_{\mathcal{Q}_{R,0},\mathcal{S}^\sharp}^{\text{TIME}^\sharp}).$$

Let us instantiate our framework. Here, we opt for the priority assumption proposed in logical modelling [13]. To each integer  $r \in \llbracket 1, n \rrbracket$ , we associate a kinetic function  $k_r$  between the set  $\mathcal{Q}_R$  and the set  $\wp(\mathbb{R}^+) \setminus \{\emptyset\}$ :

$$k_r : \mathcal{Q}_R \longrightarrow \wp(\mathbb{R}^+) \setminus \{\emptyset\}.$$

The set  $k_r(q)$  denotes the potential propensity of the reaction indexed by  $r$  in the state  $q$  according to the (maybe partial) information that we may have about the rate of this reaction. We use a set (as opposed to a single value) to model the fact that the rates of the reactions may be partially known.

The separation between time scales is encoded by a subset  $Sep$  of  $(\mathbb{R}^+)^2$  satisfying:

- (i) for any  $(x, y) \in Sep$ ,  $x < y$ ;
- (ii) for any  $x, y, x', y' \in \mathbb{R}^+$ , if  $(x, y) \in Sep$ ,  $x' \leq x$ , and  $y \leq y'$ , then  $(x', y') \in Sep$ .

The subset  $Sep$  is a user-defined parameter that tunes the underlying assumptions of the modelling paradigm, allowing the user to be more or less permissive when considering whether two quantities are well separated. Intuitively, the fact that a pair  $(x, y)$  belongs to the set  $Sep$  denotes that the value  $y$  is considered to be much higher than the value  $x$ . This parameter has to be defined at the level of the language, and it sets how time scale separation is handled in this choice of semantics, for each model of this language. The function  $k_r$  is a user-defined parameter of the model, but it can be defined generically at the level of the modelling language, for instance by assuming that  $k_r$  follows the law of mass action (see Prop. 5).

We define the concrete scheduler  $\mathcal{S}$  as follows:

$$\mathcal{S} : \begin{cases} \mathcal{Q}_R \times T_R^* \rightarrow \wp(\llbracket 1, n \rrbracket) \\ \tau \quad \mapsto \{r \mid \forall r' \in \llbracket 1, n \rrbracket, k_r(\text{final}(\tau)) \times k_{r'}(\text{final}(\tau)) \not\subseteq Sep\}. \end{cases}$$

This way, the scheduler  $\mathcal{S}$  maps each pretrace  $\tau \in \mathcal{Q}_R \times T_R^*$  to the set of the reactions  $r$  such that for all reactions  $r'$ , we have  $k_r(\text{final}(\tau)) \times k_{r'}(\text{final}(\tau)) \not\subseteq Sep$ , meaning that the reaction  $r$  may be fast enough to exclude preemption by any other reaction.

In Property 4, we abstract away the dependency with respect to the concrete state  $\text{final}(\tau)$  so as to get an effective instantiation for the parameter  $\mathcal{S}^\sharp$ .

**Property 4 (time scale separation).** *For any integer  $r' \in \llbracket 1, n \rrbracket$  and any abstract state  $q^\sharp \in \mathcal{Q}_R^\sharp$ , we denote by  $k^\sharp(r', q^\sharp)$  the set of real values that is defined as follows:*

$$k^\sharp(r', q^\sharp) \triangleq \alpha^{\mathbb{R}} \left( \bigcup \{k_{r'}(q) \mid q \in \gamma^{\mathcal{Q}}(\{q^\sharp\})\} \right),$$

*and introduce the abstract values  $k_{lb}^\sharp(r', q^\sharp)$  and  $k_{ub}^\sharp(r', q^\sharp)$  that are defined as follows:*

$$k_{lb}^\sharp(r', q^\sharp) \triangleq \min k^\sharp(r', q^\sharp),$$



and

$$k_{ub}^\sharp(r', q^\sharp) \triangleq \max k^\sharp(r', q^\sharp).$$

Let  $(q^\sharp, r)$  be a pair in  $\mathcal{Q}_R^\sharp \times \llbracket 1, n \rrbracket$ .

If both following conditions are satisfied:

(1)  $k_{ub}^\sharp(r, q^\sharp) \neq p$ ,

(2) and  $(\delta^{k_{ub}^\sharp(r, q^\sharp)+1}, \delta^{\max\{k_{lb}^\sharp(r', q^\sharp) \mid r' \in \llbracket 1, n \rrbracket\}}) \in \text{Sep}$ ,

then, for any state  $q \in \gamma^\mathcal{Q}(\{q^\sharp\})$ , there exists an integer  $r' \in \llbracket 1, n \rrbracket$  such that the following condition:

$$(k_r(q), k_{r'}(q)) \subseteq \text{Sep}$$

is satisfied as well.

Proof of Property 4 is given in Appendix A.4.

In Property 4, we abstract away the history of the system, and focus on the last state of the current trace. Our goal is to prove that whatever the current state  $q$  is, but knowing its abstraction  $q^\sharp$  (such that  $q^\sharp = \beta^\mathcal{Q}(q)$ ), the reaction  $r$  is preempted by at least one other reaction  $r' \in \llbracket 1, n \rrbracket$ . Thus, we use the expression  $\delta^{k_{ub}^\sharp(r, q^\sharp)+1}$  as an upper bound to the value of the kinetic function  $k_r$ , when it is applied to any concrete state  $q'$  that is compatible with the current abstract state  $q^\sharp$  (i.e. such that  $\beta^\mathcal{Q}(q') = q^\sharp$ ), and for each reaction  $r'$ , we use the expression  $\delta^{k_{lb}^\sharp(r', q^\sharp)}$  as a lower bound to the value of the kinetic functions  $k_{r'}$ , when it is applied to any concrete state  $q'$  that is compatible with the current abstract state  $q^\sharp$ .

The abstraction that is provided in Property 4 can be refined easily according to the need of the modeller. In the following property, we provide a more accurate property that can be applied in the case of mass-action law kinetics (with imprecise kinetic constants), or more generally whenever the kinetic function can be expressed as the product between an interval over the real fields, and a function ranging over the set of the non negative integers.

**Property 5 (time scale separation with mass-action law kinetics).** We assume that for any integer  $r' \in \llbracket 1, n \rrbracket$ , there exist two non negative real numbers  $\Gamma_{lb}(r')$  and  $\Gamma_{ub}(r')$ , and a function  $K_{r'}$  mapping each state  $q \in \mathcal{Q}_R$  into a non negative integer  $K_{r'}(q) \in \mathbb{N}$  such that the following constraint is satisfied:

$$k_{r'}(q) \subseteq \{\Gamma K_{r'}(q) \mid \Gamma \in \mathbb{R}_{\geq 0}, \Gamma_{lb}(r') \leq \Gamma \leq \Gamma_{ub}(r')\}.$$

For any integer  $r' \in \llbracket 1, n \rrbracket$  and any abstract state  $q^\sharp \in \mathcal{Q}_R^\sharp$ , we denote by  $K^\sharp(r', q^\sharp)$  the set of real values that is defined as follows:

$$K^\sharp(r', q^\sharp) \triangleq \alpha^\mathbb{R} \left( \bigcup \{K_{r'}(q) \mid q \in \gamma^\mathcal{Q}(\{q^\sharp\})\} \right),$$

and introduce the abstract values  $K_{lb}^\sharp(r', q^\sharp)$  and  $K_{ub}^\sharp(r', q^\sharp)$  that are defined as follows:

$$K_{lb}^\sharp(r', q^\sharp) \triangleq \min K^\sharp(r', q^\sharp),$$

and

$$K_{ub}^\sharp(r', q^\sharp) \triangleq \max K^\sharp(r', q^\sharp).$$

Let  $(q^\sharp, r)$  be a pair in  $\mathcal{Q}_R^\sharp \times \llbracket 1, n \rrbracket$ .

If both following conditions are satisfied:

$$(1) K_{ub}^\sharp(r, q^\sharp) \neq p,$$

$$(2) \text{ and } \left( \Gamma_{ub}(r)(\delta^{K_{ub}^\sharp(r, q^\sharp)+1} - 1), \max \left\{ \Gamma_{lb}(r') \delta^{K_{lb}^\sharp(r', q^\sharp)} \mid r' \in \llbracket 1, n \rrbracket \right\} \right) \in \text{Sep},$$

then, for any state  $q \in \gamma^\mathcal{Q}(\{q^\sharp\})$ , there exists an integer  $r' \in \llbracket 1, n \rrbracket$  such that the following condition:

$$(k_r(q), k_{r'}(q)) \subseteq \text{Sep}$$

is satisfied as well.

Proof of Property 5 is given in Appendix A.5.

In contrast with Property 4, in Property 5, we exploit the fact that the number of instances of chemical species ranges over the set of the non negative integers, which allows the computation of a more precise upper bound on the values taken by the kinetic functions  $k_r$ . Of course, if more kinetic information is available, more precise abstractions can be provided.

In Property 6, we provide a direct computation of the expression of the abstract upper and lower bounds  $K_{lb}^\sharp$  and  $K_{ub}^\sharp$  for mono- and bi-molecular reactions under the assumption of mass action stochastic law.

**Property 6 (abstract kinetic function in the case of mass-action law).**

We assume that the kinetic function  $k_r$  follows the mass-action stochastic law (with imprecise kinetic constants), that is to say, for any reaction  $r$  in  $\llbracket 1, n \rrbracket$  there exist two non negative real numbers  $a_{lb}(r)$  and  $a_{ub}(r)$  such that:

$$k_r(q) \subseteq \{ \Gamma K_r(q) \mid \Gamma \in \mathbb{R}_{\geq 0}, \Gamma_{lb}(r) \leq \Gamma \leq \Gamma_{ub}(r) \},$$

where  $K_r$  is the function mapping each state  $q \in \mathcal{Q}_R$  into the non negative integer  $K_r(q) \in \mathbb{N}$  that is defined as follows:

$$K_r(q) \triangleq \prod_{x \in \nu} \left( \frac{q(x)!}{(q(x) - M_r(x))!} \right),$$

and  $\Gamma_{lb}(r)$  and  $\Gamma_{ub}(r)$  are two non-negative real numbers defined as follows:

$$\Gamma_{lb}(r) \triangleq \frac{a_{lb}(r)}{\prod_{x \in \nu} M_r(x)!}, \quad \Gamma_{ub}(r) \triangleq \frac{a_{ub}(r)}{\prod_{x \in \nu} M_r(x)!}.$$

We further assume that  $\delta > 3$ .

Then:

- (1) If  $r$  is monomolecular of reactant  $x_0$ , that is to say if  $M_r(x_0) = 1$  and  $M_r(x) = 0$  for any chemical species  $x \in \nu \setminus \{x_0\}$ , we have:

$$\begin{cases} K_{lb}^\sharp(r, q^\sharp) &= q^\sharp(x_0); \\ K_{ub}^\sharp(r, q^\sharp) &= q^\sharp(x_0). \end{cases}$$

- (2) If  $r$  is bimolecular of reactant  $x_0$ , that is to say if  $M_r(x_0) = 2$  and  $M_r(x) = 0$  for any chemical species  $x \in \nu \setminus \{x_0\}$ , we have:

$$\begin{cases} K_{lb}^\sharp(r, q^\sharp) &= \min(\max(0, 2q^\sharp(x_0) - 1), p); \\ K_{ub}^\sharp(r, q^\sharp) &= \min(2q^\sharp(x_0) + 1, p). \end{cases}$$

(3) If  $r$  is bimolecular of reactants  $x_1$  and  $x_2$ , that is to say if  $M_r(x_1) = 1$ ,  $M_r(x_2) = 1$  and  $M_r(x) = 0$  for any chemical species  $x \in \nu \setminus \{x_1, x_2\}$ , we have:

$$\begin{cases} K_{lb}^\sharp(r, q^\sharp) &= \begin{cases} 0 & \text{whenever } q^\sharp(x_1)q^\sharp(x_2) = 0, \\ \min(q^\sharp(x_1) + q^\sharp(x_2), p) & \text{whenever } q^\sharp(x_1)q^\sharp(x_2) \neq 0; \end{cases} \\ K_{ub}^\sharp(r, q^\sharp) &= \min(q^\sharp(x_1) + q^\sharp(x_2) + 1, p). \end{cases}$$

Proof of Property 6 is given in Appendix A.6.

**Example 15.** Figure 9 gives an illustration of the induced set of abstract transitions, for the case study of the race between a unary and a binary reaction:

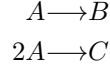

refined with time scale separation, and starting from any state  $q$  such that:

$$\begin{cases} \beta^\mathcal{Q}(q)(A) = 2, \\ \beta^\mathcal{Q}(q)(B) = 0, \\ \beta^\mathcal{Q}(q)(C) = 0. \end{cases}$$

Here we assume that  $p = 2$  and that the parameter  $Sep$ , which encodes the separation between time scales, is defined as the subset of  $(\mathbb{R}^+)^2$  such that for any  $(x, y) \in Sep$ ,  $x < y$ .

We further assume that the reactions follow the mass-action stochastic law with precise kinetic constants. We set the kinetic constant of the unary reaction to 1 and the kinetic constant of the binary reaction to  $2\delta$ . It follows that the kinetic functions are defined, for any state  $q$ , as:

$$k_1(q) = \Gamma_1 K_1(q)$$

with:

$$\Gamma_1 = 1 \quad \text{and} \quad K_1(q) = q(A),$$

for the unary reaction, and:

$$k_2(q) = \Gamma_2 K_2(q),$$

with:

$$\Gamma_2 = \delta \quad \text{and} \quad K_2(q) = q(A)(q(A) - 1),$$

for the binary reaction.

Following Property 5, we define the parameter of our refinement  $\mathcal{S}^\sharp$  as the set of couples  $(q^\sharp, r)$  such that:

- (1) either  $K_{ub}^\sharp(r, q^\sharp) = p$ ,
- (2) or  $\left( \Gamma_r (\delta^{K_{ub}^\sharp(r, q^\sharp)+1} - 1), \max \left\{ \Gamma_{r'} \delta^{K_{lb}^\sharp(r', q^\sharp)} \mid r' \in \llbracket 1, n \rrbracket \right\} \right) \notin Sep$ ,

Then, following Property 6, we can compute the upper and lower bounds  $K_{lb}^\sharp(r', q^\sharp)$  and  $K_{ub}^\sharp(r', q^\sharp)$  of the abstract kinetic functions of the unary and the binary reactions as follows:

$$K_{lb}^\sharp(1, q^\sharp) = \begin{cases} 0 & \text{if } q^\sharp(A) = 0 \\ 1 & \text{if } q^\sharp(A) = 1 \\ 2 & \text{if } q^\sharp(A) = 2, \end{cases}$$

and, for any state  $q^\sharp$ :

$$K_{ub}^\sharp(1, q^\sharp) = K_{lb}^\sharp(1, q^\sharp),$$

for the unary reaction, and:

$$K_{lb}^\sharp(2, q^\sharp) = \begin{cases} 0 & \text{if } q^\sharp(A) = 0 \\ 1 & \text{if } q^\sharp(A) = 1 \\ 2 & \text{if } q^\sharp(A) = 2, \end{cases}$$

and:

$$K_{ub}^\sharp(2, q^\sharp) = \begin{cases} 1 & \text{if } q^\sharp(A) = 0 \\ 2 & \text{if } q^\sharp(A) \in \{1, 2\}, \end{cases}$$

for the binary reaction.

It follows that, for any state  $q^\sharp$  which satisfies  $q^\sharp(A) = 1$ :

$$\left( \Gamma_1(\delta^{K_{ub}^\sharp(1, q^\sharp)+1} - 1), \Gamma_2 \delta^{K_{lb}^\sharp(2, q^\sharp)} \right) \in \text{Sep}$$

and thus that:

$$(q^\sharp, 1) \notin \mathcal{S}^\sharp,$$

while any other couple  $(q^\sharp, r)$ , for which  $q^\sharp(A) \neq 1$ , belongs to  $\mathcal{S}^\sharp$ .

The transitions discarded by our refinement (i.e. those which do not belong to  $\mathcal{S}^\sharp$ ) are depicted by the grey arrows in Figure 9. By soundness of the abstraction (Thm. 4), we can prove from the induced abstract semantics that, whenever the number of instances of  $A$  belongs to the interval  $\llbracket \delta, \delta^2 \rrbracket$ , there is no concrete transition applying the unary reaction that makes the number of instances of at least one chemical species change its sampling interval.

#### 5.4. Reduced product

In the previous sections, we have introduced three refinements of the abstract semantics. Each of them is focusing on a special class of reasoning. We show here how to combine these refinements in an approximation of their reduced product [15, 24].

The resulting analysis is parameterised by a triple:

$$\text{param} \triangleq (\text{inv}_p^\sharp, \text{esc}^\sharp, \mathcal{S}^\sharp)$$

where:

- $\text{inv}_p^\sharp$  is a pair  $(\text{Cov}, f)$  such that  $\text{Cov}$  is a covering of the set  $\mathcal{Q}_{R,0}$  of the initial states, and  $f$  a function mapping each covering class  $\mathcal{Q}'_{R,0} \in \text{Cov}$  into a set of states that is defined by the means of semi-positive constraints over the number of instances of the chemical species;

- $esc^\sharp$  is a subset of  $\mathcal{Q}_R^\sharp \times \mathcal{C}_\dagger \times \llbracket 1, n \rrbracket$ ;
- $\mathcal{S}^\sharp$  is a subset of the set  $\mathcal{Q}_R^\sharp \times \llbracket 1, n \rrbracket$ .

Roughly speaking, the component  $inv_p^\sharp$  covers the set of the initial states, and maps each covering class to some mass invariants for the states that can be reached from these specific initial states. It is used to partition [22] the analysis in order to consider together only the initial states sharing the same mass preservation invariants (in the abstract). The second component is the parameter of the second refinement (see Sect. 5.2). The third component is the parameter of the third refinement (see Sect. 5.3).

Abstract states in the second refinement are refined with constraints, whereas the abstract states in the others are not. This induces a type mismatch. To solve this mismatch, we introduce a Galois connection  $(\alpha_{fst}, \gamma_{fst})$  to pass from sets of abstract states with constraints to sets of states.

More precisely,

- (1) the function  $\alpha_{fst}$  maps each subset  $X \subseteq \mathcal{Q}_R^\sharp \times \wp(\mathcal{C}_\dagger)$  to the following set:

$$\{q^\sharp \mid (q^\sharp, C) \in X\}.$$

- (2) whereas the function  $\gamma_{fst}$  maps each subset  $Y \subseteq \mathcal{Q}_R^\sharp$  to the following one:

$$\{(q^\sharp, C) \mid q^\sharp \in Y, C \subseteq \mathcal{C}_\dagger\}.$$

We denote by  $(\alpha_{fst}^\dagger, \gamma_{fst}^\dagger)$  the lift of the Galois connection  $(\alpha_{fst}, \gamma_{fst})$  over traces.

For any covering class  $\mathcal{Q}'_{R,0} \in Cov$ , we define a function  $\mathbb{F}_{\mathcal{Q}'_{R,0}, param}^{\text{PROD}\sharp}$  over the powerset  $\wp(\mathcal{T}_{esc^\sharp}^{\text{CROSS}\sharp})$ , which maps any set  $Y \subseteq \mathcal{T}_{esc^\sharp}^{\text{CROSS}\sharp}$  of abstract (pre)traces (with constraints) to the set of abstract (pre)traces (with constraints) that is defined as follows:

$$\mathbb{F}_{\mathcal{Q}'_{R,0}, param}^{\text{PROD}\sharp}(Y) \triangleq \gamma_{fst}^\dagger \left( \mathbb{F}_{\mathcal{Q}'_{R,0}, f(\mathcal{Q}'_{R,0})}^{\text{INV}\sharp}(\alpha_{fst}^\dagger(Y)) \right) \cap \mathbb{F}_{\mathcal{Q}'_{R,0}, esc^\sharp}^{\text{CROSS}\sharp}(Y) \cap \gamma_{fst}^\dagger \left( \mathbb{F}_{\mathcal{Q}'_{R,0}, \mathcal{S}^\sharp}^{\text{TIME}\sharp}(\alpha_{fst}^\dagger(Y)) \right).$$

Intuitively, the function  $\mathbb{F}_{\mathcal{Q}'_{R,0}, param}^{\text{PROD}\sharp}$  keeps only the abstract transition steps that are enabled in each of our three abstractions (this construction is usually called a coalescent product [18]). Since the signature of each abstract domain is different, we use the function  $\gamma_{fst}^\dagger$  to convert abstract elements without constraints to abstract elements with constraints. We notice that the function  $\gamma_{fst}^\dagger$  is very permissive and allow any constraints. This is not an accuracy issue, since the constraints are handled by the second abstraction.

It is worth noticing that, for any set  $Y \subseteq \mathcal{T}_{esc^\sharp}^{\text{CROSS}\sharp}$ , the set  $\mathbb{F}_{\mathcal{Q}'_{R,0}, param}^{\text{PROD}\sharp}(Y)$  can also be written as follows:

$$\{\beta_\dagger^{\mathcal{Q}}(q) \mid q \in \mathcal{Q}'_{R,0}\} \cup \left\{ \tau \frown ((q^\sharp, C), r, (q^{\sharp'}, C')) \left| \begin{array}{l} ((q^\sharp, C), r, (q^{\sharp'}, C')) \in T_{param}^{\text{PROD}\sharp} \\ \wedge \tau \in Y \\ \wedge final(\tau) = q^\sharp \end{array} \right. \right\},$$

where  $T_{param}^{\text{PROD}\sharp}$  is defined as the subset of  $(\mathcal{Q}_R^\sharp \times \wp(\mathcal{C}_\dagger)) \times \llbracket 1, n \rrbracket \times (\mathcal{Q}_R^\sharp \times \wp(\mathcal{C}_\dagger))$  that contains exactly the triples  $((q^\sharp, C), r, (q^{\sharp'}, C'))$  such that:

- (1)  $(q^\sharp, C) \neq (q^{\sharp'}, C')$ ;
- (2)  $q^\sharp, q^{\sharp'} \in \alpha^{\mathcal{Q}}(f(\mathcal{Q}'_{R,0}))$ ;
- (3)  $((q^\sharp, C), r, (q^{\sharp'}, C')) \in T_{esc^\sharp}^{\text{CROSS}^\sharp}$ ;
- (4)  $(q^\sharp, r) \in \mathcal{S}^\sharp$ .

In the definition of  $T_{param}^{\text{PROD}^\sharp}$ , the conditions check that the state or the constraints are changed (condition 1), and that the transition is allowed in each of the three refinements (condition 2, 3 and 4). No other reduction is performed: a transition is allowed only if it is allowed in each abstraction. We also notice that each refinement can be disabled by tuning the parameters appropriately. For instance, putting no semi-positive constraints disables the refinement due to mass preservation constraints.

The function  $\mathbb{F}_{\mathcal{Q}_{R,0}, param}^{\text{PROD}^\sharp}$  is monotonic. Hence, by [16], it has a least fix-point. We can now establish under which assumptions about the parameters our analysis is sound.

**Theorem 5 (soundness).** *We assume that:*

- (1)  $\delta > 2V_\infty$ ,  $\delta > M_\infty$ ,  $\delta > (M + V)_\infty$ ;
- (2) for any class  $\mathcal{Q}'_{R,0} \in \text{Cov}$  and any state  $q \in \mathcal{Q}'_{R,0}$ , we have  $q \in f(\mathcal{Q}'_{R,0})$ ;
- (3) for any class  $\mathcal{Q}'_{R,0} \in \text{Cov}$ , for any (concrete) transition  $(q, r, q') \in T_R$ , if  $q \in f(\mathcal{Q}'_{R,0})$ , then  $q' \in f(\mathcal{Q}'_{R,0})$ ;
- (4)  $esc \subseteq esc^\sharp$ ;
- (5) for any concrete trace  $\tau \in \mathcal{T}_{\mathcal{R}, \mathcal{Q}_{R,0}, \mathcal{S}}^{\text{TIME}}$  and any transition  $(q, r, q') \in T_R$  that satisfy:
  - (a)  $final(\tau) = q$ ,
  - (b)  $\beta^{\mathcal{Q}}(q) \neq \beta^{\mathcal{Q}}(q')$ , and
  - (c)  $r \in \mathcal{S}(\tau)$ ,

we have:

$$r \in \mathcal{S}^\sharp(\beta^{\mathcal{T}}(\tau)).$$

Under these assumptions, we have:

$$\mathcal{T}_{\mathcal{R}, \mathcal{Q}'_{R,0}, \mathcal{S}}^{\text{TIME}} \subseteq \gamma_{\dagger}^{\mathcal{T}}(\text{lfp } \mathbb{F}_{\mathcal{Q}'_{R,0}, param}^{\text{PROD}^\sharp})$$

for any covering class  $\mathcal{Q}'_{R,0} \in \text{Cov}$ .

Proof of Theorem 5 is given in Appendix A.7.

In Theorem 5, we have collected all the assumptions coming from our underlying refinements. In particular, we have assumed  $\delta$  large enough (assumption 1), ensuring that all the asynchronous updatings are taken into account (see Prop. 1) and that the assumption about  $\delta$  in the second refinement is satisfied (see Sect. 5.2). We have further assumed that for each class of the covering of the initial states, the associated semi-positive constraints are satisfied by the

states in this covering class (assumption 2), and that these constraints are preserved by the application of the reactions (assumption 3). Besides, we have assumed that the set of the chemical species that can reach the upper bound of their interval is over-approximated (assumption 4), and that the preemption between reactions is under-approximated (assumption 5).

## 6. Application to the case studies

We now show the applications of our abstraction refined with the three properties described in the previous section on our case studies (see Sect. 2). We start by describing the assumptions of our modelling. Then, we show the qualitative models automatically derived for each case study using our prototype implementation [14].

### 6.1. Modelling assumptions

We state here the assumptions underlying the modelling and the abstraction of our case studies, which ensure the correctness of our analysis (Thm. 5). We assume that:

- the parameter  $\delta$  of our abstraction satisfies  $\delta > 6$ , ensuring that  $\delta > M_\infty$ ,  $\delta > 2V_\infty$  and  $\delta > (M + V)_\infty$  (which are conditions required for the correctness of our analysis (Thm. 5)), and also ensuring that  $\delta > (n + 1)V_\infty$ , as required by the forthcoming Property 7;
- the constraint  $b \geq S\delta^{\beta^{\mathbb{R}}(b)}$ , where  $S$  denotes the maximum of the sum  $\sum_s \alpha_s$  for the mass invariant equation  $\sum_s \alpha_s q(s) = b$ , holds for each mass invariant equation; this constraint further ensures that the abstraction of the total number of instances of a protein is equal to the abstraction of the number of instances of the most abundant chemical species containing this protein (Prop. 2);
- the parameter  $esc^\sharp$  of our refinement on the constraint on upwards interval crossing is defined as the set of triples  $(q^\sharp, x_\dagger, r)$  which satisfy the following conditions:
  - (1) either  $\delta^{q^\sharp(x)} < \alpha(q^\sharp, x)$ , where  $\alpha$  is the function mapping each couple  $(q^\sharp, x')$  to the non negative integer  $\alpha(q^\sharp, x')$  defined as follows:
 
$$\alpha(q^\sharp, x') = \max(\delta^{\min(q^\sharp(z) \mid M_{r'}(z) > 0) + 1} \mid r' \in \llbracket 1, n \rrbracket, V_{r'}(x') > 0);$$
  - (2) or there exist a chemical species  $y$  and two reactions  $r'$  and  $r''$  in  $\llbracket 1, n \rrbracket$  which satisfy the following conditions:
    - (a)  $V_{r'}(x) > 0$ ,
    - (b)  $M_{r'}(y) < 0$ ,
    - (c)  $q^\sharp(y) = \min(q^\sharp(z) \mid M_{r'}(z) > 0)$ ,
    - (d)  $V_{r''}(y) > 0$ ;
- the subset  $Sep$ , which encodes the separation between time scales, is defined as the set of pairs  $(x, y) \in (\mathbb{R}^+)^2$  such that  $x < y$ ;

- the kinetic functions  $k_r$  of any reaction  $r \in \llbracket 1, n \rrbracket$  follow the mass-action stochastic law with precise kinetic constants, that is to say for any reaction  $r$  in  $\llbracket 1, n \rrbracket$  we have:

$$k_r(q) = \Gamma(r)K_r(q),$$

where  $K_r$  is the function mapping each state  $q \in \mathcal{Q}_R$  into a non negative integer  $K_r(q)$  defined as follows:

$$K_r(q) = \prod_{x \in \nu} \left( \frac{q(x)!}{(q(x) - M_r(x))!} \right)$$

and  $\Gamma_r$  is a non-negative real number defined as follows:

$$\Gamma_r = \frac{a_r}{\prod_{x \in \nu} M_r(x)!}$$

where  $a_r$  is a non negative real number denoting the kinetic constant of reaction  $r$ ;

- following Property 5, the parameter  $\mathcal{S}^\sharp$  of our refinement on time scale separation is defined as the set of couples  $(q^\sharp, r)$  such that:

- (1) either  $K_{ub}^\sharp(r, q^\sharp) = p$ ,
- (2) or  $\left( \Gamma_r(\delta^{K_{ub}^\sharp(r, q^\sharp)+1} - 1), \max \left\{ \Gamma_{r'} \delta^{K_{ib}^\sharp(r', q^\sharp)} \mid r' \in \llbracket 1, n \rrbracket \right\} \right) \notin \text{Sep}$ .

Finally, for sake of clarity, we will further:

- quotient the states that have the same state values but different sets of annotated chemical species;
- consider asynchronous transitions (i.e. transitions in which the number of instances of at most one chemical species can move simultaneously from an interval to another one) and discard the other types of transitions since, in the qualitative models derived for our case studies, any transition can be simulated by asynchronous ones (more details on asynchronous updating policy can be found in Appendix B).

Note that we use the standard primitives that we have suggested in the core of the framework, except for the primitive  $esc^\sharp$ . Indeed we have taken a simpler primitive for the sake of simplicity.

This simplified primitive is sound, as stated in the following property:

**Property 7.** *We assume that  $\delta > (n + 1)V_\infty$ . Then  $esc^\sharp$  is a superset of  $esc$ .*

Proof of Property 7 is given in Appendix A.8.

In this simplified version of the primitive  $esc^\sharp$ , we abstract away the dependency of the triples  $(q^\sharp, x_\dagger, r)$  on reaction  $r$  and focus on proving whether, at the state  $q^\sharp$ :

- (1) there is not enough resources of the limiting reactants which produce the chemical species  $x$  (condition (1));
- (2) none of the limiting reactants producing the chemical species  $x$  is a product of any reaction of the system (condition (2)).



## 6.2. The model with the adaptor

We present in this section the qualitative model automatically derived for the case study of the model with the adaptor:

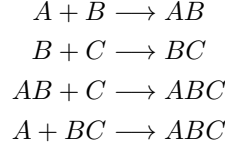

We assume that the modelling hypothesis (ensuring the correctness of our analysis), stated in Section 6.1, are fulfilled. Moreover:

- we assume that  $p = 6$ , providing enough sampling intervals in our abstraction for the applications of our refinements;
- we set the value of the kinetic constants  $a_r$  of all the reactions to 1;
- we take as mass invariants the preservation of the overall number of  $A$ s, the overall number of  $B$ s and the overall number of  $C$ s; these constraints are expressed as the following mass conservation equations:

$$\begin{cases} q(A) + q(AB) + q(ABC) = A_T, \\ q(B) + q(AB) + q(BC) + q(ABC) = B_T, \\ q(C) + q(BC) + q(ABC) = C_T. \end{cases}$$

We denote each abstract state  $q^\sharp$  by the following sextuple:

$$(q^\sharp(A), q^\sharp(B), q^\sharp(C), q^\sharp(AB), q^\sharp(BC), q^\sharp(ABC)).$$

The induced sets of abstract transitions are shown in Figures 10 and 16 for two different sets of initial conditions. Figure 10 shows the case where we start from any initial state  $q$  such that  $\beta^\mathcal{Q}(q)$  satisfies the following constraints:

$$\begin{cases} \beta^\mathcal{Q}(q)(A) &= 2, \\ \beta^\mathcal{Q}(q)(B) &= 4, \\ \beta^\mathcal{Q}(q)(C) &= 2, \\ \beta^\mathcal{Q}(q)(AB) &= 0, \\ \beta^\mathcal{Q}(q)(BC) &= 0, \\ \beta^\mathcal{Q}(q)(ABC) &= 0. \end{cases}$$

with mass constants  $A_T = 3\delta^2$ ,  $B_T = 4\delta^4$  and  $C_T = 3\delta^2$ . Here we thus start from a state for which the number of instances of  $B$  is very high and the number of instances of  $A$  and  $C$  are low. We see that the set of transitions forms a diamond shape which can be interpreted through the interplay of our three refinements as follows. First the mass invariant refinement imposes that the level of  $B$  is stuck to 4 and that the levels of  $A$ ,  $C$ ,  $AB$  and  $BC$  cannot increase above 2. Thus, due to the time scale separation refinement, the reactions producing  $ABC$  will always be preempted by at least one of the other reactions until both levels of  $A$  and  $C$  may reach the level 0. Then the mass

invariant refinement further imposes that the level of  $A$  (resp. the level of  $C$ ) cannot decrease before either the level of  $AB$  (resp. the level of  $AC$ ) may have reached level 2. Therefore starting from any initial state, the levels of  $AB$  and  $BC$  may start to increase until they reach the level 2. If  $AB$  (resp.  $BC$ ) reaches this level,  $A$  (resp.  $C$ ) may decrease until both  $A$  and  $C$  may reach the lowest level 0 (state  $(0, 4, 0, 2, 2, 0)$ ). At this state, the reactions producing  $ABC$  are no more preempted. Thus  $ABC$  may be updated but its level will not increase more than 1 due to the upwards crossing interval constraint, thereby reaching the asymptotic state with a very low level of  $ABC$  (state  $(0, 4, 0, 2, 2, 1)$ ). Due to the overapproximation, we cannot conclude that, in the concrete system, a concrete state corresponding to the state  $(0, 4, 0, 2, 2, 1)$  is reachable from a state that satisfies the initial condition. Yet by soundness of our abstraction, we can conclude that the number of instances of the protein  $ABC$  will never reach the value  $\delta^2$ , and thus will always remain very low. Therefore the abstraction refined with our three properties is able to capture the sequestration effect appearing in the concrete system of our case study.

Figure 16 shows the induced set of abstract transitions in the case where we start from any initial state  $q$  such that  $\beta^{\mathcal{Q}}(q)$  satisfies the following constraints:

$$\left\{ \begin{array}{l} \beta^{\mathcal{Q}}(q)(A) = 2, \\ \beta^{\mathcal{Q}}(q)(B) = 1, \\ \beta^{\mathcal{Q}}(q)(C) = 2, \\ \beta^{\mathcal{Q}}(q)(AB) = 0, \\ \beta^{\mathcal{Q}}(q)(BC) = 0, \\ \beta^{\mathcal{Q}}(q)(ABC) = 0. \end{array} \right.$$

with mass constants  $A_T = 3\delta^2$ ,  $B_T = 4\delta$  and  $C_T = 3\delta^2$ . Here we thus start from initial states for which the number of instances of  $B$  is low and the number of instances of  $A$  and  $C$  are high. The deployment of the transitions can be interpreted through the sole mass invariant refinement (the other two refinements do not further discard transitions after the application of the mass invariant constraints). In particular, the mass invariant refinement imposes that the levels of  $A$  and  $C$  are stuck to 2 while the level of  $B$  may decrease but not before either the level of  $AB$ ,  $BC$  or  $ABC$  may increase. We see that the behaviour of the abstract system converges to a cycle composed of states with low or very low levels of  $AB$ ,  $BC$  and  $ABC$  (states  $(2, 0, 2, 0, 0, 1)$ ,  $(2, 0, 2, 0, 1, 1)$ ,  $(2, 0, 2, 1, 0, 1)$  and  $(2, 0, 2, 1, 1, 1)$ ). Due to the overapproximation, we cannot conclude that the concrete system will go in that cycle starting from a state that satisfies the initial condition. Yet by soundness of the abstraction we can conclude that the number of instances of the chemical species  $AB$ ,  $BC$  and  $ABC$  will always remain less than  $\delta^2$ .

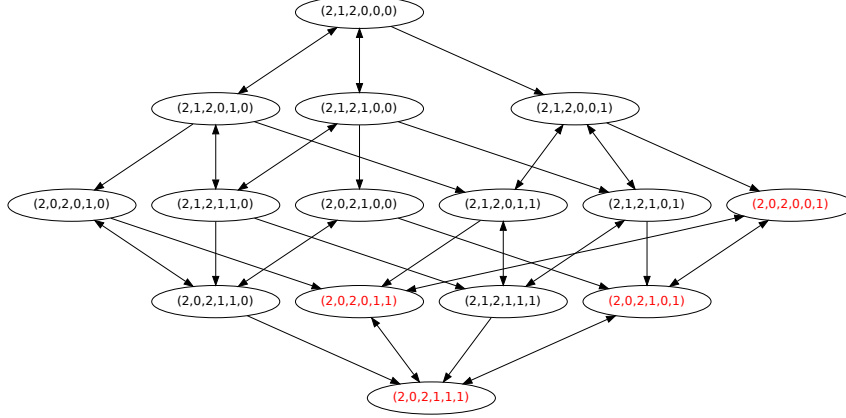
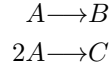

Figure 16: Set of abstract transitions refined with our three properties (the mass invariants, the limiting resources for interval crossing, and time scale separation) for the case study of the model with the adaptor, starting from any initial state  $q$  which satisfies:  $\beta^{\mathcal{Q}}(q)(A) = 2$ ,  $\beta^{\mathcal{Q}}(q)(B) = 1$ ,  $\beta^{\mathcal{Q}}(q)(C) = 2$ ,  $\beta^{\mathcal{Q}}(q)(AB) = 0$ ,  $\beta^{\mathcal{Q}}(q)(BC) = 0$ ,  $\beta^{\mathcal{Q}}(q)(ABC) = 0$ , under the modelling assumptions stated in Section 6. Nodes represent states, while arrows denote single or multiple transitions. The reactions associated with the transitions are omitted. Red states denote those composing the cyclic attractor.

### 6.3. The model with a race between a unary and a binary reaction

We present in this section the qualitative model automatically derived for the case study with a race between a unary and a binary reaction:



We assume that the modelling hypothesis (ensuring the correctness of our analysis), stated in Section 6.1, are fulfilled. Moreover:

- we assume that  $p = 12$ , providing enough sampling intervals in our abstraction for the applications of our refinements;
- we set the kinetic constant of the unary reaction to  $\delta^4$  and the kinetic constant of the binary reaction to 2;
- we take as mass invariants the preservation of the overall number of As, Bs and Cs:

$$q(A) + q(B) + 2q(C) = A_T.$$

We denote each abstract state  $q^\sharp$  by the triple  $(q^\sharp(A), q^\sharp(B), q^\sharp(C))$ .

The induced sets of abstract transitions are shown in Figure 17 for two different sets of initial conditions. Figure 17(a) shows the case where we start from any initial state  $q$  such that  $\beta^{\mathcal{Q}}(q)$  satisfies the following constraints:

$$\begin{cases} \beta^{\mathcal{Q}}(q)(A) = 2, \\ \beta^{\mathcal{Q}}(q)(B) = 0, \\ \beta^{\mathcal{Q}}(q)(C) = 0. \end{cases}$$

with mass constant  $A_T = 4\delta^2$ . Here we thus start from initial states for which the number of instances of  $A$  is low. The set of transitions forms a linear chain of states that can be interpreted through the interplay of our three refinements as follows. At any initial state, the binary reaction does not occur as it is preempted by the unary one, while  $A$  is stuck to its initial level 2 due to the mass invariant constraint.  $B$  may thus increase to the maximum level (2) allowed by the mass invariant before  $A$  may decrease. If the level of  $A$  decreases to the level 1, the unary reaction still preempts the binary one. If  $A$  reaches the level 0, the binary reaction is released leading to the potential production of  $C$ . The level of  $C$  may then increase by 1 but not more due to the upwards crossing interval constraint, leading to an asymptotic state with a very low level of  $C$  (level 1) and a low level of  $B$  (level 2). Due to the overapproximation, we cannot conclude that the concrete model will reach such a state from a state that satisfies the initial condition. It might happen that the system is stuck earlier in the trace. Yet by soundness of our abstraction, we can conclude that, if the concrete system escapes the set of initial conditions, then the number of instances of  $B$  will always be higher than the number of instances of  $C$ . Therefore, the abstract model is able to predict that, with these initial conditions, the unary reaction wins the race against the binary reaction.

Figure 17(b) shows the case where we start from any initial state  $q$  such that  $\beta^{\mathcal{Q}}(q)$  satisfies the following constraints:

$$\begin{cases} \beta^{\mathcal{Q}}(q)(A) &= 7, \\ \beta^{\mathcal{Q}}(q)(B) &= 0, \\ \beta^{\mathcal{Q}}(q)(C) &= 0. \end{cases}$$

with mass constant  $A_T = 4\delta^7$ . Here we thus start from initial states for which the number of instances of  $A$  is very high. The deployment of the transitions can be interpreted through the interplay of our three refinements as follows. At any initial state, the unary reaction is preempted by the binary one, due to the time scale separation refinement, leading to the potential production of  $C$ , while  $A$  is stuck to its initial level, due to the mass invariant refinement, until  $C$  may reach the maximum level (7) allowed by the mass invariant constraint (state  $(7, 0, 7)$ ).  $A$  may then be consumed until its level is low enough to release the unary reaction (state  $(5, 0, 7)$ ). From then on, the unary reaction is no more preempted and can thus occur, leading potentially either to an increase of  $B$  or a decrease of  $A$  until the system may reach a state where the levels of  $B$  and  $C$  are equal but below 5. From then on, the level of  $B$  may increase but will never reach the level 7 due to the upwards crossing interval constraint, leading to an asymptotic state with a higher level of  $C$  (level 7) than  $B$  (level 6). Here again, due to the overapproximation, we cannot conclude whether, or not, the concrete model will reach such a state with these initial conditions. It might happen that the system is stuck earlier in the trace. Yet by soundness of our abstraction, we can conclude that, if the concrete system escapes the set of initial conditions, then the number of instances of  $C$  will always be higher than the number of instances of  $B$ . Therefore, the abstract model is able to predict that, with these initial conditions, the binary reaction wins the race against the unary one.

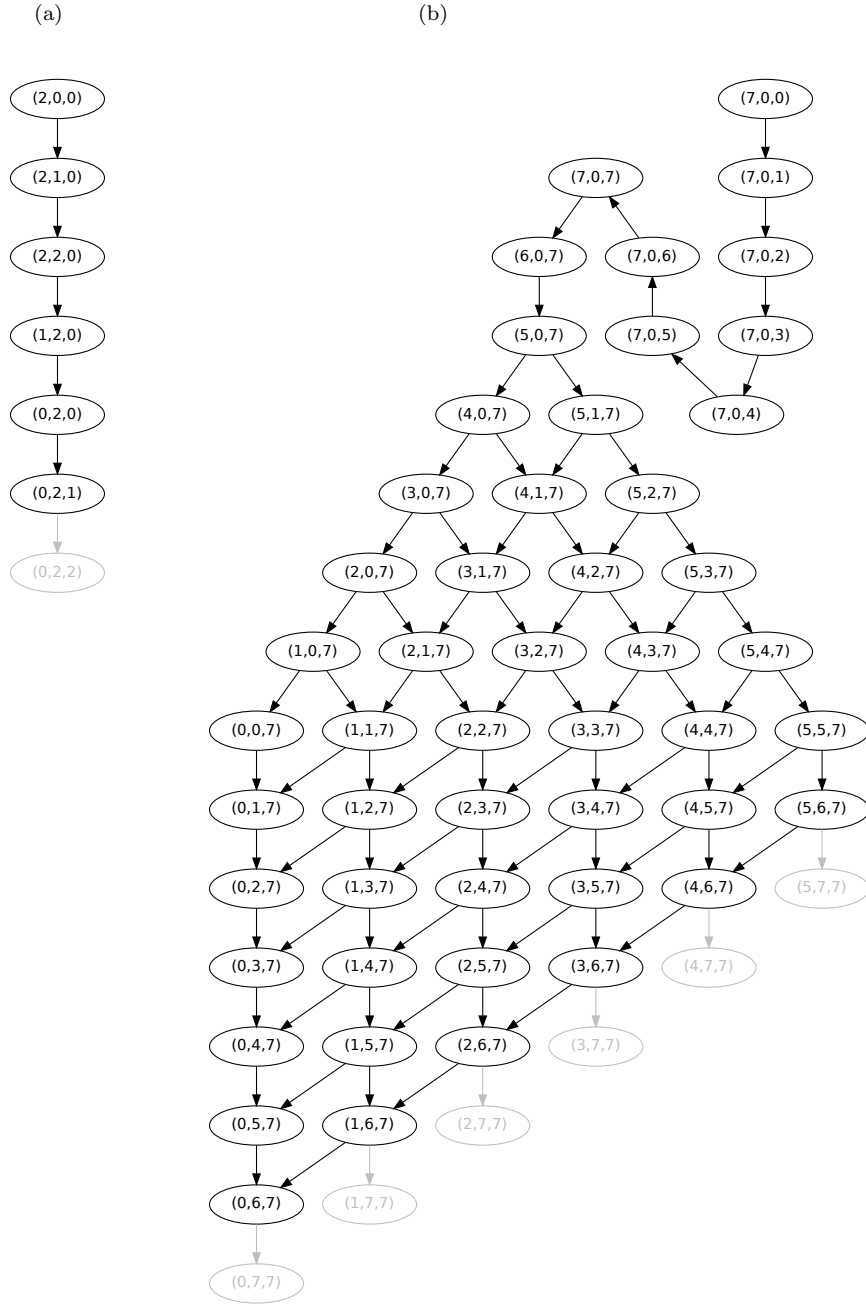

Figure 17: Set of abstract transitions refined with our three properties (the mass invariants, the limiting resources for interval crossing, and time scale separation) for the case study of the race between a unary and a binary reaction, starting from any initial state  $q$  which satisfies:  $\beta^{\mathcal{Q}}(q)(A) = 2$ ,  $\beta^{\mathcal{Q}}(q)(B) = 0$  and  $\beta^{\mathcal{Q}}(q)(C) = 0$  (Fig. 17(a)), or which satisfies:  $\beta^{\mathcal{Q}}(q)(A) = 7$ ,  $\beta^{\mathcal{Q}}(q)(B) = 0$  and  $\beta^{\mathcal{Q}}(q)(C) = 0$  (Fig. 17(b)), under the modelling assumptions stated in Section 6. Nodes represent states, while arrows denote single or multiple transitions. The reactions associated with the transitions are omitted. Grey arrows denote transitions discarded by the refinement on limiting resources for interval crossing.

## 7. Conclusion

We have designed a formal framework to derive qualitative dynamical models from reaction networks, using the abstract interpretation framework to formally relate the behaviors of models seen at different levels of abstraction. We have illustrated our approach on two relevant case studies. Interestingly, our framework accounts for sophisticated properties such as concurrency, sequestration phenomena and race between competing reactions, which arise in the case studies. Notably, it can capture a sequestration effect, which appears in the case study of the model with the adaptor. Indeed we can prove, from the derived qualitative model, that when the number of instances of the adaptor protein  $B$  is very high and those of the binding proteins  $A$  and  $C$  are low in the initial state, then the number of instances of the complex  $ABC$  remains very low.

The assumptions underlying our methodology are clearly established. This not only allows to properly reassess the assumptions made, but it also provides flexibility in the modelling process, allowing the modeller to test different hypotheses and to integrate various sets of constraints, for example concerning the choice of mass preservation constraints kept in the framework, or regarding the assumptions made about time scale separation. Here we opted for the priority based assumption on time scale separation that has been proposed in logical modelling [13]. This assumption states that a fast process (belonging to the highest priority class) preempts any other much slower processes (belonging to lower priority classes). It is worthy noting that the assumption we made on time scale separation represents a choice of semantics. Other assumptions could have been used in our framework. In particular one alternative approach consists in releasing the priority based assumption considering fairness hypotheses that bound the frequencies of slow reaction steps. Other assumptions inspired from the differential semantics could also be considered [25, 26]. Moreover we should point out that some behaviours arising in biochemical networks might not be handled by a particular choice of semantics. This is for example the case of large time relaxations of fast cycles (which are absent in our particular case studies), which is not captured by the priority based assumption, as it discards the slow reactions that are involved in relaxation processes, but that could be handled considering fairness hypotheses.

Our methodology offers new trade-offs between complexity and accuracy. It captures interesting properties that are beyond the scope of purely qualitative abstractions [4] and avoids the integration of numerical equations [6, 5]. Our framework is purely formal and provides a better understanding of the qualitative modelling process, by clarifying the underlying assumptions. In particular a main implicit assumption made in qualitative modelling concerns the consideration of discrete levels for the variables, each level representing a different range of the number of instances of the model components. Here we show that solely sampling the number of instances of chemical species within a finite number of intervals in reaction networks leads to the loss of almost all the information on the system dynamics. Additional refinements are required to capture properties of interest. Here we introduce three refinements corresponding to different classes of reasoning: the mass invariants, the constraints on the crossing of intervals, and the time scale separation, all necessary to capture the properties of interest in our case studies. Interestingly, we notice that our approach often requires more intervals than in tropical approaches [5]. This is not so surpris-

ing, since in tropical approaches two consecutive intervals are assumed to be infinitely far from each other, whereas in our approach they contain arbitrarily close elements.

It is worth noting that, beyond the scope of the case studies considered in this work, the properties of interest captured by our framework have been shown to play a significant role in shaping the dynamics of cell signalling and regulatory networks. Indeed scaffolding can quantitatively affect cell signal propagation, in particular through sequestration effects [11]. Moreover it is known that the dynamics of cellular biochemical processes operates in a wide range of time scales, covering several orders of magnitudes: signal transduction and metabolic processes can occur in fractions of seconds, while receptor internalization and transcriptional regulation can take several minutes [27].

One current limitation of our method is that we use one variable per chemical species, leading to a combinatorial explosion of the dynamics as the model size increases. To cope with this limitation, we plan to extend our framework to the reduced reaction networks obtained by the fragmentation of the models written in the kappa language [28, 29], which would allow to handle larger signalling networks (e.g. EGFR network [28], MAPK network [1]). Such reduced networks involve non semi-positive invariants, which would need to be taken into account in our extended framework. Additional prospects of this work include the analysis of other relevant case studies showing properties of interest and the identification of the modelling refinements allowing to capture these properties.

## References

- [1] L. Grieco, L. Calzone, I. Bernard-Pierrot, F. Radvanyi, B. Kahn-Perlès, D. Thieffry, Integrative modelling of the influence of MAPK network on cancer cell fate decision, *PLoS Computational Biology* 9 (2013) e1003286.
- [2] A. Niarakis, Y. Bounab, L. Grieco, R. Roncagalli, A. M. Hesse, J. Garin, B. Malissen, M. Daeron, D. Thieffry, Computational modeling of the main signaling pathways involved in mast cell activation, *Current Topics in Microbiology and Immunology* 382 (2014) 69–93.
- [3] W. Abou-Jaoudé, P. Traynard, P. T. Monteiro, J. Saez Rodriguez, T. Helikar, D. Thieffry, C. Chaouiya, Logical modeling and dynamical analysis of cellular networks, *Frontiers in Genetics* 7 (94) (2016) .
- [4] F. Fages, S. Soliman, Formal cell biology in Biocham, in: M. Bernardo, P. Degano, G. Zavattaro (Eds.), *Formal Methods for Computational Systems Biology*, Vol. 5016 of *Lecture Notes in Computer Science*, Springer Berlin Heidelberg, 2008, pp. 54–80.
- [5] O. Radulescu, A. N. Gorban, A. Zinovyev, V. Noel, Reduction of dynamical biochemical reactions networks in computational biology, *Frontiers in Genetics* 3 (131) (2012) .
- [6] H. De Jong, J.-L. Gouzé, C. Hernandez, M. Page, T. Sari, J. Geiselmann, Qualitative simulation of genetic regulatory networks using piecewise-linear models, *Bulletin of Mathematical Biology* 66 (2) (2004) 301–340.

- [7] P. Cousot, Constructive design of a hierarchy of semantics of a transition system by abstract interpretation, *Theoretical Computer Science* 277 (1–2) (2002) 47–103.
- [8] B. Blanchet, P. Cousot, R. Cousot, J. Feret, L. Mauborgne, A. Miné, D. Monniaux, X. Rival, A static analyzer for large safety-critical software, in: R. Cytron, R. Gupta (Eds.), *Proceedings of the ACM SIGPLAN 2003 Conference on Programming Language Design and Implementation 2003*, San Diego, California, USA, June 9-11, 2003, ACM, 2003, pp. 196–207.
- [9] M. Fähndrich, F. Logozzo, Static contract checking with abstract interpretation, in: B. Beckert, C. Marché (Eds.), *Formal Verification of Object-Oriented Software - International Conference, FoVeOOS 2010*, Paris, France, June 28-30, 2010, Revised Selected Papers, Vol. 6528 of *Lecture Notes in Computer Science*, Springer, 2010, pp. 10–30.
- [10] A. Chapoutot, M. Martel, Abstract simulation: A static analysis of simulink models, in: *Proceedings of the International Conference on Embedded Software and Systems, ICCESS '09*, IEEE Computer Society, 2009, pp. 83–92.
- [11] S. A. Chapman, A. R. Asthagiri, Quantitative effect of scaffold abundance on signal propagation, *Molecular Systems Biology* 5 (1) (2009) 313.
- [12] C. Chaouiya, Petri net modelling of biological networks, *Briefings in Bioinformatics* 8 (4) (2007) 210–219.
- [13] A. Faure, A. Naldi, C. Chaouiya, D. Thieffry, Dynamical analysis of a generic Boolean model for the control of the mammalian cell cycle, *Bioinformatics* 22 (14) (2006) e124–131.
- [14] W. Abou-Jaoudé, Prototype, <https://github.com/aboujaoudew>.
- [15] P. Cousot, R. Cousot, Abstract interpretation: A unified lattice model for static analysis of programs by construction or approximation of fixpoints, in: *Proceedings of the 4th ACM SIGACT-SIGPLAN Symposium on Principles of Programming Languages, POPL '77*, ACM, 1977, pp. 238–252.
- [16] A. Tarski, A lattice-theoretical fixpoint theorem and its applications, *Pacific Journal of Mathematics* 5 (2) (1955) 285–309.
- [17] S. C. Kleene, *Introduction to metamathematics*, ISHI Press International, 1952.
- [18] P. Cousot, Méthodes itératives de construction et d'approximation de points fixes d'opérateurs monotones sur un treillis, analyse sémantique de programmes (in French), Thèse d'État ès sciences mathématiques, Université Joseph Fourier, Grenoble, France (21 March 1978).
- [19] M. Karr, Affine relationships among variables of a program, *Acta Informatica* 6 (1976) 133–151.
- [20] J. Feret, Occurrence counting analysis for the pi-calculus, *Electronic Notes in Theoretical Computer Science* 39 (2) (2000) 1–18.



- [21] S. Schuster, T. Hofer, Determining all extreme semi-positive conservation relations in chemical reaction systems: a test criterion for conservativity, *Journal of the Chemical Society, Faraday Transactions* 87 (1991) 2561–2566.
- [22] F. Bourdoncle, Abstract interpretation by dynamic partitioning, *Journal of Functional Programming* 2 (4) (1992) 407–423.
- [23] X. Rival, L. Mauborgne, The trace partitioning abstract domain, *ACM Transactions on Programming Languages and Systems* 29 (5).
- [24] P. Cousot, R. Cousot, J. Feret, L. Mauborgne, A. Miné, D. Monniaux, X. Rival, Combination of abstractions in the ASTRÉE static analyzer, in: M. Okada, I. Satoh (Eds.), *Advances in Computer Science - ASIAN 2006. Secure Software and Related Issues*, Vol. 4435 of *Lecture Notes in Computer Science*, Springer Berlin Heidelberg, 2007, pp. 272–300.
- [25] A. N. Gorban, O. Radulescu, Dynamic and static limitation in multiscale reaction networks, revisited, in: G. Marin, D. West, G. Yablonsky (Eds.), *Advances in Chemical Engineering: Mathematics in Chemical Kinetics and Engineering*, Vol. 34 of *Advances in Chemical Engineering*, Academic Press, 2008, pp. 103 – 173.
- [26] Radulescu, O., Vakulenko, S., Grigoriev, D., Model reduction of biochemical reactions networks by tropical analysis methods, *Mathematical Modelling of Natural Phenomena* 10 (3) (2015) 124–138.
- [27] J. A. Papin, B. O. Palsson, The JAK-STAT signaling network in the human B-cell: an extreme signaling pathway analysis, *Biophysical Journal* 87 (1) (2004) 37–46.
- [28] J. Feret, V. Danos, J. Krivine, R. Harmer, W. Fontana, Internal coarse-graining of molecular systems, *Proceedings of the National Academy of Sciences* 106 (16) (2009) 6453–6458.
- [29] J. Feret, H. Koepl, T. Petrov, Stochastic fragments: A framework for the exact reduction of the stochastic semantics of rule-based models, *International Journal of Software and Informatics* 7 (4) (2013) 527–604.

Table 1: List of symbols used in the text with description and pointers to their definition pages.

Symbol	Type	Description	Page of definition
$r$	$\in \llbracket 1, n \rrbracket$	Reaction	12
$\nu$		Set of chemical species	12
$M_r$	$\in \nu \rightarrow \mathbb{N}$	Multi-set of chemical species associated to the reaction $r$	12
$V_r$	$\in \nu \rightarrow \mathbb{Z}$	Reaction vector associated to the reaction $r$	12
$R$	$\triangleq (\nu, (M_r, V_r)_{1 \leq r \leq n})$	Reaction network	12
$n$	$\in \mathbb{N}$	Number of reactions of a reaction network	12
$\mathcal{Q}_R$	$\triangleq \mathbb{N}^\nu$	Set of states of $R$	14
$T_R$	$\subseteq \mathbb{N}^\nu \times \llbracket 1, n \rrbracket \times \mathbb{N}^\nu$	Set of transitions of $R$	14
$(\mathcal{Q}_R, T_R)$		Transition system induced by $R$	14
$\tau$	$\in \mathcal{Q}_R \times T_R^*$	(Pre)trace	14
$first$	$\in \mathcal{Q}_R \times T_R^* \rightarrow \mathcal{Q}_R$	Initial state of a (pre)trace	14
$final$	$\in \mathcal{Q}_R \times T_R^* \rightarrow \mathcal{Q}_R$	Final state of a (pre)trace	14
$\mathcal{Q}_{R,0}$	$\subseteq \mathcal{Q}_R$	Set of initial states of $R$	15
$\mathcal{T}_{R, \mathcal{Q}_{R,0}}$	$\subseteq \mathcal{Q}_R \times T_R^*$	Set of traces induced by $R$ and $\mathcal{Q}_{R,0}$	15
$\mathbb{F}_{\mathcal{Q}_{R,0}}$	$\in \wp(\mathcal{Q}_R \times T_R^*) \rightarrow \wp(\mathcal{Q}_R \times T_R^*)$	Transfer function over sets of traces	15
$\delta$	$\in \mathbb{N}$	Parameter of the sampling of values	17
$p$	$\in \mathbb{N}$	Number of sampling intervals $-1$	17
$\beta^{\mathbb{R}}$	$\in \mathbb{R}^+ \rightarrow \llbracket 0, p \rrbracket$	Abstraction function of values	17
$\mathcal{Q}_R^\sharp$	$\triangleq \llbracket 0, p \rrbracket^\nu$	Set of abstract states of $R$	17
$T_R^\sharp$	$\subseteq \llbracket 0, p \rrbracket^\nu \times \llbracket 1, n \rrbracket \times \llbracket 0, p \rrbracket^\nu$	Set of abstract transitions induced by $R$	17

Table 1: (continued)

Symbol	Type	Description	Page of definition
$(\mathcal{Q}_R^\sharp, T_R^\sharp)$		Abstract transition system induced by $R$	17
$\beta^{\mathcal{Q}}$	$\in \mathcal{Q}_R \rightarrow \mathcal{Q}_R^\sharp$	Abstraction function of states	17
$T_{R/\varepsilon}^\sharp$	$\subseteq \llbracket 0, p \rrbracket^\nu \times \llbracket 1, n \rrbracket \times \llbracket 0, p \rrbracket^\nu$	Set of non-silent abstract transitions induced by $R$	18
$\beta^{\mathcal{T}}$	$\in \mathcal{Q}_R \times T_R^* \rightarrow \mathcal{Q}_R^\sharp \times T_{R/\varepsilon}^{\sharp*}$	Abstraction function of traces	18
$\mathbb{F}_{\mathcal{Q}_{R,0}}^\sharp$	$\in \wp(\mathcal{Q}_R^\sharp \times T_{R/\varepsilon}^{\sharp*}) \rightarrow \wp(\mathcal{Q}_R^\sharp \times T_{R/\varepsilon}^{\sharp*})$	Abstract transfer function over sets of traces	19
$\alpha^{\mathcal{T}}$	$\in \wp(\mathcal{Q}_R \times T_R^*) \rightarrow \wp(\mathcal{Q}_R^\sharp \times T_{R/\varepsilon}^{\sharp*})$	Abstraction function of sets of traces	19
$\gamma^{\mathcal{T}}$	$\in \wp(\mathcal{Q}_R^\sharp \times T_{R/\varepsilon}^{\sharp*}) \rightarrow \wp(\mathcal{Q}_R \times T_R^*)$	Concretization function of sets of traces	19
$\alpha^{\mathbb{R}}$	$\in \wp(\mathbb{R}^+) \rightarrow \wp(\llbracket 0, p \rrbracket)$	Abstraction function of sets of values	20
$\alpha^{\mathcal{Q}}$	$\in \wp(\mathcal{Q}_R) \rightarrow \wp(\mathcal{Q}_R^\sharp)$	Abstraction function of sets of states	20
$\gamma^{\mathbb{R}}$	$\in \wp(\llbracket 0, p \rrbracket) \rightarrow \wp(\mathbb{R}^+)$	Concretization function of sets of values	20
$\gamma^{\mathcal{Q}}$	$\in \wp(\mathcal{Q}_R^\sharp) \rightarrow \wp(\mathcal{Q}_R)$	Concretization function of sets of states	20
$\mathcal{T}_{\mathcal{Q}_{R,0}}^\sharp$	$\subseteq \mathcal{Q}_R^\sharp \times T_{R/\varepsilon}^{\sharp*}$	Set of abstract traces induced by $R$ and $\mathcal{Q}_{R,0}$	20
$V_\infty$	$\in \mathbb{N}$	Maximum of the set $\{ V_i(x)  \mid i \in \llbracket 1, n \rrbracket, x \in \nu\}$	21
$M_\infty$	$\in \mathbb{N}$	Maximum of the set $\{ M_i(x)  \mid i \in \llbracket 1, n \rrbracket, x \in \nu\}$	21
$(M + V)_\infty$	$\in \mathbb{N}$	Maximum of the set $\{ M_i(x) + V_i(x)  \mid i \in \llbracket 1, n \rrbracket, x \in \nu\}$	21
$inv$	$\subseteq \mathcal{Q}_R \times T_R^*$	Trace invariant	27
$\mathbb{F}_{\mathcal{Q}_{R,0}, inv}^{INV}$	$\in \wp(\mathcal{Q}_R \times T_R^*) \rightarrow \wp(\mathcal{Q}_R \times T_R^*)$	Transfer function over sets of traces refined with $inv$	27
$\mathbb{F}_{\mathcal{Q}_{R,0}, inv}^{INV^\sharp}$	$\in \wp(\mathcal{Q}_R^\sharp \times T_{R/\varepsilon}^{\sharp*}) \rightarrow \wp(\mathcal{Q}_R^\sharp \times T_{R/\varepsilon}^{\sharp*})$	Abstract transfer function over sets of traces refined with $inv$	27
$\mathcal{C}_\dagger$	$\in \wp(\nu)$	Set of constraints on upwards interval crossing	31

Table 1: (continued)

Symbol	Type	Description	Page of definition
$\beta_{\dagger}^{\mathcal{Q}}$	$\in \mathcal{Q}_R \rightarrow \mathcal{Q}_R^{\#} \times \wp(\mathcal{C}_{\dagger})$	Abstraction function of states refined with $\mathcal{C}_{\dagger}$	31
$\beta_{\dagger}^{\mathcal{T}}$	$\in \mathcal{Q}_R \times T_R^* \rightarrow ((\mathcal{Q}_R^{\#} \times \wp(\mathcal{C}_{\dagger})) \times ((\mathcal{Q}_R^{\#} \times \wp(\mathcal{C}_{\dagger})) \times \llbracket 1, n \rrbracket \times (\mathcal{Q}_R^{\#} \times \wp(\mathcal{C}_{\dagger})))^*$	Abstraction function of traces refined with $\mathcal{C}_{\dagger}$	31
$\alpha_{\dagger}^{\mathcal{Q}}$	$\in \wp(\mathcal{Q}_R) \rightarrow \wp(\mathcal{Q}_R^{\#} \times \wp(\mathcal{C}_{\dagger}))$	Abstraction function of sets of states refined with $\mathcal{C}_{\dagger}$	31
$\alpha_{\dagger}^{\mathcal{T}}$	$\in \wp(\mathcal{Q}_R \times T_R^*) \rightarrow \wp(((\mathcal{Q}_R^{\#} \times \wp(\mathcal{C}_{\dagger})) \times ((\mathcal{Q}_R^{\#} \times \wp(\mathcal{C}_{\dagger})) \times \llbracket 1, n \rrbracket \times (\mathcal{Q}_R^{\#} \times \wp(\mathcal{C}_{\dagger})))^*)$	Abstraction function of sets of traces refined with $\mathcal{C}_{\dagger}$	31
$\gamma_{\dagger}^{\mathcal{Q}}$	$\in \wp(\mathcal{Q}_R^{\#} \times \wp(\mathcal{C}_{\dagger})) \rightarrow \wp(\mathcal{Q}_R)$	Concretization function of sets of states refined with $\mathcal{C}_{\dagger}$	31
$\gamma_{\dagger}^{\mathcal{T}}$	$\in \wp(((\mathcal{Q}_R^{\#} \times \wp(\mathcal{C}_{\dagger})) \times ((\mathcal{Q}_R^{\#} \times \wp(\mathcal{C}_{\dagger})) \times \llbracket 1, n \rrbracket \times (\mathcal{Q}_R^{\#} \times \wp(\mathcal{C}_{\dagger})))^*) \rightarrow \wp(\mathcal{Q}_R \times T_R^*)$	Concretization function of sets of traces refined with $\mathcal{C}_{\dagger}$	31
$esc$	$\subseteq \mathcal{Q}_R^{\#} \times \mathcal{C}_{\dagger} \times \llbracket 1, n \rrbracket$	Set used to define an over-approximation of the set of abstract traces refined with $\mathcal{C}_{\dagger}$	31
$esc^{\#}$	$\subseteq esc$	Superset of $esc$ - parameter of the refinement on the interval crossing constraint	32
$T_{esc^{\#}}^{\text{CROSS}^{\#}}$	$\subseteq (\mathcal{Q}_R^{\#} \times \wp(\mathcal{C}_{\dagger})) \times \llbracket 1, n \rrbracket \times (\mathcal{Q}_R^{\#} \times \wp(\mathcal{C}_{\dagger}))$	Set of abstract transitions refined with $esc^{\#}$	32
$\mathcal{T}_{esc^{\#}}^{\text{CROSS}^{\#}}$	$\in \wp(((\mathcal{Q}_R^{\#} \times \wp(\mathcal{C}_{\dagger})) \times ((\mathcal{Q}_R^{\#} \times \wp(\mathcal{C}_{\dagger})) \times \llbracket 1, n \rrbracket \times (\mathcal{Q}_R^{\#} \times \wp(\mathcal{C}_{\dagger})))^*)$	Set of abstract traces refined with $esc^{\#}$	35
$\mathbb{F}_{\mathcal{Q}_R, 0, esc^{\#}}^{\text{CROSS}^{\#}}$	$\in \wp(\mathcal{T}_{esc^{\#}}^{\text{CROSS}^{\#}}) \rightarrow \wp(\mathcal{T}_{esc^{\#}}^{\text{CROSS}^{\#}})$	Abstract transfer function over sets of traces refined with $esc^{\#}$	35
$\mathcal{S}$	$\in \mathcal{Q}_R \times T_R^* \rightarrow \wp(\llbracket 1, n \rrbracket)$	Scheduler - restricts the set of reactions which can occur immediately after a (pre)trace	38
$\mathbb{F}_{\mathcal{Q}_R, 0, \mathcal{S}}^{\text{TIME}}$	$\in \wp(\mathcal{Q}_R \times T_R^*) \rightarrow \wp(\mathcal{Q}_R \times T_R^*)$	Transfer function over sets of traces refined with $\mathcal{S}$	38

Table 1: (continued)

Symbol	Type	Description	Page of definition
$\mathcal{T}_{R, \mathcal{Q}_{R,0}, S}^{\text{TIME}}$	$\subseteq \mathcal{Q}_R \times T_R^*$	Set of traces induced by $R$ and $\mathcal{Q}_{R,0}$ and refined with $S$	38
$\mathcal{S}^\sharp$	$\in \mathcal{Q}_R^\sharp \times T_{R/\varepsilon}^{\sharp*} \rightarrow \wp(\llbracket 1, n \rrbracket)$	Parameter of the time scale separation refinement - function used to lift the action of $S$ to the abstract semantics	38
$\mathbb{F}_{\mathcal{Q}_{R,0}, \mathcal{S}^\sharp}^{\text{TIME}\sharp}$	$\in \wp(\mathcal{Q}_R^\sharp \times T_{R/\varepsilon}^{\sharp*}) \rightarrow \wp(\mathcal{Q}_R^\sharp \times T_{R/\varepsilon}^{\sharp*})$	Abstract transfer function over sets of traces refined with $\mathcal{S}^\sharp$	38
$\mathit{Sep}$	$\subseteq \mathbb{R}^2$	Set encoding the separation between time scales	39
$k_r$	$\in \mathcal{Q}_R \rightarrow \wp(\mathbb{R}^+) \setminus \{\emptyset\}$	Kinetic function of reaction $r$	39
$k^\sharp$	$\in \llbracket 1, n \rrbracket \times \mathcal{Q}_R^\sharp \rightarrow \wp(\llbracket 0, p \rrbracket)$	Abstract kinetic function	39
$k_{lb}^\sharp$	$\in \llbracket 1, n \rrbracket \times \mathcal{Q}_R^\sharp \rightarrow \llbracket 0, p \rrbracket$	Lower bound of $k^\sharp$	39
$k_{ub}^\sharp$	$\in \llbracket 1, n \rrbracket \times \mathcal{Q}_R^\sharp \rightarrow \llbracket 0, p \rrbracket$	Upper bound of $k^\sharp$	39
$K_r$	$\in \mathcal{Q}_R \rightarrow \mathbb{N}$	Integer term of the kinetic function of reaction $r$	40
$\Gamma_{lb}$	$\in \llbracket 1, n \rrbracket \rightarrow \mathbb{R}^+$	Lower bounds of the kinetic constants of the reactions	40
$\Gamma_{ub}$	$\in \llbracket 1, n \rrbracket \rightarrow \mathbb{R}^+$	Upper bounds of the kinetic constants of the reactions	40
$K^\sharp$	$\in \llbracket 1, n \rrbracket \times \mathcal{Q}_R^\sharp \rightarrow \wp(\llbracket 0, p \rrbracket)$	Abstraction of the function $K_r$	40
$K_{lb}^\sharp$	$\in \llbracket 1, n \rrbracket \times \mathcal{Q}_R^\sharp \rightarrow \llbracket 0, p \rrbracket$	Lower bounds of $K^\sharp$	40
$K_{ub}^\sharp$	$\in \llbracket 1, n \rrbracket \times \mathcal{Q}_R^\sharp \rightarrow \llbracket 0, p \rrbracket$	Upper bounds of $K^\sharp$	40
$\mathit{param}$	$\triangleq (\mathit{inv}_p^\sharp, \mathit{esc}^\sharp, \mathcal{S}^\sharp)$	Parameter of the analysis	43
$\mathit{Cov}$		Covering of a set of states	43
$\mathit{inv}_p^\sharp$	$\in \mathit{Cov} \times (\mathit{Cov} \rightarrow \wp(\mathcal{Q}_R))$	Parameter accounting for the constraint of mass invariants	43
$\alpha_{fst}$	$\in \wp(\mathcal{Q}_R^\sharp \times \wp(\mathcal{C}_\dagger)) \rightarrow \wp(\mathcal{Q}_R^\sharp)$	Abstraction function from sets of abstract states with constraints to sets of abstract states	44

Table 1: (continued)

Symbol	Type	Description	Page of definition
$\gamma_{fst}$	$\in \wp(\mathcal{Q}_R^\sharp) \rightarrow \wp(\mathcal{Q}_R^\sharp \times \wp(\mathcal{C}_\dagger))$	Concretization function from sets of abstract states to sets of abstract states with constraints	44
$\alpha_{fst}$	$\in \wp((\mathcal{Q}_R^\sharp \times \wp(\mathcal{C}_\dagger)) \times ((\mathcal{Q}_R^\sharp \times \wp(\mathcal{C}_\dagger)) \times \llbracket 1, n \rrbracket \times (\mathcal{Q}_R^\sharp \times \wp(\mathcal{C}_\dagger)))^*) \rightarrow \wp(\mathcal{Q}_R^\sharp \times T_{R/\varepsilon}^{\sharp*})$	Abstraction function from sets of abstract traces with constraints to sets of abstract traces	44
$\dot{\gamma}_{fst}$	$\in \wp(\mathcal{Q}_R^\sharp \times T_{R/\varepsilon}^{\sharp*}) \rightarrow \wp((\mathcal{Q}_R^\sharp \times \wp(\mathcal{C}_\dagger)) \times ((\mathcal{Q}_R^\sharp \times \wp(\mathcal{C}_\dagger)) \times \llbracket 1, n \rrbracket \times (\mathcal{Q}_R^\sharp \times \wp(\mathcal{C}_\dagger)))^*)$	Concretization function from sets of abstract traces to sets of abstract traces with constraints	44
$\mathbb{F}_{\mathcal{Q}'_{R,0},param}^{\text{PROD}\sharp}$	$\in \wp(\mathcal{T}_{esc}^{\text{CROSS}\sharp}) \rightarrow \wp(\mathcal{T}_{esc}^{\text{CROSS}\sharp})$	Abstract transfer function refined with <i>param</i>	44
$T_{param}^{\text{PROD}\sharp}$	$\subseteq (\mathcal{Q}_R^\sharp \times \wp(\mathcal{C}_\dagger)) \times \llbracket 1, n \rrbracket \times (\mathcal{Q}_R^\sharp \times \wp(\mathcal{C}_\dagger))$	Set of abstract transitions refined with <i>param</i>	44

## Appendix A. Proofs

### Appendix A.1. Proof of Property 1

We remind the reader of the statement of Property 1, before giving a proof of it.

**Property 1.** *The following assertions hold:*

- (1) *For any part  $Y \subseteq \mathcal{Q}_R^\sharp \times T_{R/\varepsilon}^{\sharp*}$ , the following inclusion:*

$$\mathbb{F}_{\mathcal{Q}_{R,0}}^\sharp(Y) \subseteq Y \cup \alpha^\mathcal{Q}(\mathcal{Q}_{R,0}) \cup \left\{ \tau^\sharp \frown (q^\sharp, r, q^{\sharp'}) \left| \begin{array}{l} \tau^\sharp \in Y \\ \wedge (q^\sharp, r, q^{\sharp'}) \in T_{R/\varepsilon}^\sharp \\ \wedge \text{final}(\tau^\sharp) = q^\sharp \end{array} \right. \right\},$$

*is satisfied.*

- (2) *If for any concrete transition  $(q, r, q') \in T_R$  such that  $(\beta^\mathcal{Q}(q), r, \beta^\mathcal{Q}(q')) \in T_{R/\varepsilon}^\sharp$ , there exist a state  $q''$  and a reaction  $r'$  such that  $(q'', r', q) \in T_R$  and  $\beta^\mathcal{Q}(q'') = \beta^\mathcal{Q}(q)$ , then for any part  $Y \subseteq \mathcal{Q}_R^\sharp \times T_{R/\varepsilon}^{\sharp*}$ , the following inclusion:*

$$\alpha^\mathcal{Q}(\mathcal{Q}_{R,0}) \cup \left\{ \tau^\sharp \frown (q^\sharp, r, q^{\sharp'}) \left| \begin{array}{l} \tau^\sharp \in Y \\ \wedge (q^\sharp, r, q^{\sharp'}) \in T_{R/\varepsilon}^\sharp \\ \wedge \text{final}(\tau^\sharp) = q^\sharp \end{array} \right. \right\} \subseteq \mathbb{F}_{\mathcal{Q}_{R,0}}^\sharp(Y),$$

*is satisfied.*

- (3) *For any abstract transition  $(q^\sharp, r, q^{\sharp'}) \in T_R^\sharp$ , if  $\delta > V_\infty$ , then the value  $q^{\sharp'}(x)$  is either equal to  $q^\sharp(x)$  or to  $q^\sharp(x) + \text{sign}(V_r(x))$ .*
- (4) *For any rule  $r$  and any abstract state  $q^\sharp \in \mathcal{Q}_R^\sharp$ , if  $\delta > \max(M_\infty, (M + V)_\infty)$ , then, for any chemical species  $y \in \nu$  such that  $V_r(y) \neq 0$  and  $0 \leq q^\sharp(y) + \text{sign}(V_r(y)) \leq p$ , we have:*

$$(q^\sharp, r, q^\sharp[y \mapsto q^\sharp(y) + \text{sign}(V_r(y))]) \in T_R^\sharp.$$

PROOF. We take the same notations as in the statement of Property 1.

- (1) Let us start by showing that assertion (1) holds.

Let  $Y$  be a subset of  $\mathcal{Q}_R^\sharp \times T_{R/\varepsilon}^{\sharp*}$ . By definition of  $\mathbb{F}_{\mathcal{Q}_{R,0}}^\sharp$  the following equality holds:

$$\mathbb{F}_{\mathcal{Q}_{R,0}}^\sharp(\gamma^\mathcal{T}(Y)) = \mathcal{Q}_{R,0} \cup \{ \tau \frown (q, r, q') \mid \tau \in \gamma^\mathcal{T}(Y) \wedge (q, r, q') \in T_R \wedge q = \text{final}(\tau) \}. \quad (\text{A.1})$$

Applying the function  $\alpha^\mathcal{T}$  to the previous equality it follows that:

$$\mathbb{F}_{\mathcal{Q}_{R,0}}^\sharp(Y) = \alpha^\mathcal{Q}(\mathcal{Q}_{R,0}) \cup \alpha^\mathcal{T}(S_1), \quad (\text{A.2})$$

where the set  $S_1$  is defined as follows:

$$S_1 = \{ \tau \frown (q, r, q') \mid \tau \in \gamma^\mathcal{T}(Y) \wedge (q, r, q') \in T_R \wedge q = \text{final}(\tau) \}.$$

Let us show that:

$$\alpha^\mathcal{T}(S_1) \subseteq Y \cup S_2, \quad (\text{A.3})$$

where the set  $S_2$  is defined as follows:

$$S_2 = \{\tau^\sharp \frown (q^\sharp, r, q^{\sharp'}) \mid \tau^\sharp \in Y \wedge (q^\sharp, r, q^{\sharp'}) \in T_{R/\varepsilon}^\sharp \wedge \text{final}(\tau^\sharp) = q^\sharp\}.$$

Let  $\tau^{\sharp'} \in \alpha^{\mathcal{T}}(S_1)$ . Then there exists  $\tau' \in S_1$  such that:

$$\tau^{\sharp'} = \beta^{\mathcal{T}}(\tau').$$

By definition of  $S_1$  it follows that there exists  $\tau \in \gamma^{\mathcal{T}}(Y)$  and  $(q, r, q') \in T_R$  such that:

$$\tau^{\sharp'} = \beta^{\mathcal{T}}(\tau \frown (q, r, q')), \quad (\text{A.4})$$

and such that:

$$\text{final}(\tau) = q. \quad (\text{A.5})$$

Moreover by definition of  $\beta^{\mathcal{T}}$ , it follows from Eqn. A.4 that:

$$\tau^{\sharp'} = \beta^{\mathcal{T}}(\tau) \frown \beta^{\mathcal{T}}(q, r, q'), \quad (\text{A.6})$$

and from Eqn. A.5:

$$\text{final}(\beta^{\mathcal{T}}(\tau)) = \beta^{\mathcal{Q}}(q). \quad (\text{A.7})$$

By definition of  $\tau$  it further follows that:

$$\beta^{\mathcal{T}}(\tau) \in Y. \quad (\text{A.8})$$

We then distinguish between the following two cases:

(a) if  $\beta^{\mathcal{Q}}(q) \neq \beta^{\mathcal{Q}}(q')$  then the following condition holds:

$$\beta^{\mathcal{T}}(q, r, q') \in T_{R/\varepsilon}^\sharp. \quad (\text{A.9})$$

From Eqns. A.6, A.7, A.8 and A.9, it follows that:

$$\tau^{\sharp'} \in S_2,$$

and thus that Eqn. A.3 holds.

(b) if  $\beta^{\mathcal{Q}}(q) = \beta^{\mathcal{Q}}(q')$ , then the following equality is satisfied:

$$\tau^{\sharp'} = \beta^{\mathcal{T}}(\tau).$$

From Eqn. A.8, it follows that:

$$\tau^{\sharp'} \in Y,$$

and thus that Eqn. A.3 holds,

which ends the proof of assertion (1).

(2) Let us show that assertion (2) holds.

Let  $Y$  be a subset of  $\mathcal{Q}_R^\sharp \times T_{R/\varepsilon}^{\sharp*}$ . By definition of  $\mathbb{F}_{\mathcal{Q}_{R,0}}$  the following equality holds:

$$\mathbb{F}_{\mathcal{Q}_{R,0}}(\gamma^{\mathcal{T}}(Y)) = \mathcal{Q}_{R,0} \cup \{\tau \frown (q, r, q') \mid \tau \in \gamma^{\mathcal{T}}(Y) \wedge (q, r, q') \in T_R \wedge q = \text{final}(\tau)\}.$$



Applying the function  $\alpha^{\mathcal{T}}$  to the previous equality, it follows that:

$$\mathbb{F}_{\mathcal{Q}_{R,0}}^{\sharp}(Y) = \alpha^{\mathcal{Q}}(\mathcal{Q}_{R,0}) \cup \alpha^{\mathcal{T}}(S_1).$$

where the set  $S_1$  is defined as follows:

$$S_1 = \{\tau \frown (q, r, q') \mid \tau \in \gamma^{\mathcal{T}}(Y) \wedge (q, r, q') \in T_R \wedge q = \text{final}(\tau)\}.$$

Let us show that:

$$S_2 \subseteq \alpha^{\mathcal{T}}(S_1). \quad (\text{A.10})$$

where the set  $S_2$  is defined as follows:

$$S_2 = \{\tau^{\sharp} \frown (q^{\sharp}, r, q^{\sharp'}) \mid \tau^{\sharp} \in Y \wedge (q^{\sharp}, r, q^{\sharp'}) \in T_{R/\varepsilon}^{\sharp} \wedge \text{final}(\tau^{\sharp}) = q^{\sharp}\}.$$

Let  $\tau^{\sharp'} \in S_2$ . Then by definition of  $S_2$ , there exists  $\tau^{\sharp} \in Y$  and  $(q^{\sharp}, r, q^{\sharp'}) \in T_{R/\varepsilon}^{\sharp}$  such that:

$$\tau^{\sharp'} = \tau^{\sharp} \frown (q^{\sharp}, r, q^{\sharp'}) \quad (\text{A.11})$$

and such that:

$$\text{final}(\tau^{\sharp}) = q^{\sharp}. \quad (\text{A.12})$$

By definition of  $T_{R/\varepsilon}^{\sharp}$  it follows that there exists:

$$(q, r, q') \in T_R \quad (\text{A.13})$$

such that:

$$(\beta^{\mathcal{Q}}(q), r, \beta^{\mathcal{Q}}(q')) = (q^{\sharp}, r, q^{\sharp'}), \quad (\text{A.14})$$

Since  $\tau^{\sharp} \in Y$  it also follows that there exists a pretrace  $\tau$  such that:

$$\beta^{\mathcal{T}}(\tau) = \tau^{\sharp}, \quad (\text{A.15})$$

and for which, from Eqn. A.12, the following equality is satisfied:

$$\beta^{\mathcal{Q}}(\text{final}(\tau)) = \beta^{\mathcal{Q}}(q).$$

By assumption it follows that there exist a state  $q''$  and a reaction  $r'$  such that:

$$(q'', r', q) \in T_R, \quad (\text{A.16})$$

and such that:

$$\beta^{\mathcal{Q}}(q'') = \beta^{\mathcal{Q}}(q). \quad (\text{A.17})$$

Now let  $\tau'$  be the pretrace defined as follows:

$$\tau' = \tau \frown (q'', r', q). \quad (\text{A.18})$$

and  $\tau''$  the pretrace defined as follows:

$$\tau'' = \tau' \frown (q, r, q'). \quad (\text{A.19})$$

From Eqns. A.15, A.17 and A.18, the following equality is satisfied:

$$\beta^{\mathcal{T}}(\tau') = \tau^{\sharp}. \quad (\text{A.20})$$

Since  $\tau^\sharp \in Y$  it follows that:

$$\tau' \in \gamma^{\mathcal{T}}(Y). \quad (\text{A.21})$$

Moreover from the definitions of  $\tau'$  and  $\tau''$  the following equality is satisfied:

$$q = \text{final}(\tau'). \quad (\text{A.22})$$

Then, from Eqns. A.13, A.19, A.21 and A.22, it follows that:

$$\tau'' \in S_1. \quad (\text{A.23})$$

Furthermore, from Eqns. A.11, A.14, A.19 and A.20, the following equality is satisfied:

$$\beta^{\mathcal{T}}(\tau'') = \tau^{\sharp'}. \quad (\text{A.24})$$

From Eqns. A.23 and A.24, we conclude that:

$$\tau^{\sharp'} \in \alpha^{\mathcal{T}}(S_1),$$

and thus that the inclusion A.10 holds, which ends the proof of assertion (2).

(3) Let us now show that assertion (3) holds.

Let  $(q^\sharp, r, q^{\sharp'}) \in T_R^\sharp$ . Then by definition of  $T_R^\sharp$ , there exists  $(q, r, q') \in T_R$  such that:

$$\beta^{\mathcal{Q}}(q) = q^\sharp \quad \text{and} \quad \beta^{\mathcal{Q}}(q') = q^{\sharp'} \quad (\text{A.25})$$

By definition of  $T_R$  it follows for all  $x \in \nu$  that:

$$q'(x) = q(x) + V_r(x).$$

Let  $x \in \nu$ . By definition of  $V_\infty$  we have:

$$|V_r(x)| \leq V_\infty.$$

Thus it follows that:

$$|q'(x) - q(x)| \leq V_\infty.$$

Since by assumption  $\delta > V_\infty$  it follows that:

$$|q'(x) - q(x)| < \delta.$$

Moreover by assumption  $\delta \geq 2$ . It follows for any couple of integers  $(p_1, p_2)$  such that  $p_2 > p_1$  and  $p_1 > 0$  that:

$$\delta \leq \delta^{p_2} - \delta^{p_1}.$$

Thus the following inequality holds for any couple of integers  $(p_1, p_2)$  such that  $p_2 > p_1$  and  $p_1 > 0$ :

$$|q'(x) - q(x)| < \delta^{p_2} - \delta^{p_1}. \quad (\text{A.26})$$

We now distinguish between the following cases:

(a) we assume that:

$$\beta^{\mathcal{Q}}(q')(x) > \beta^{\mathcal{Q}}(q)(x). \quad (\text{A.27})$$

Then  $q'(x) > q(x)$  and it follows from Eqn.A.26 that the following inequality holds for any couple of integers  $(p_1, p_2)$  such that  $p_2 > p_1$  and  $p_1 > 0$ :

$$q'(x) - q(x) < \delta^{p_2} - \delta^{p_1}. \quad (\text{A.28})$$

Moreover from Eqn. A.25 the following inequalities are satisfied:

$$q'(x) \geq \delta^{q^{\sharp'}(x)},$$

and:

$$q(x) < \delta^{q^{\sharp}(x)+1}.$$

It follows that:

$$q'(x) - q(x) > \delta^{q^{\sharp'}(x)} - \delta^{q^{\sharp}(x)+1}. \quad (\text{A.29})$$

Let us now assume that:

$$q^{\sharp'}(x) > q^{\sharp}(x) + 1.$$

Then from Eqns.A.28 and A.29 it follows that:

$$\delta^{q^{\sharp'}(x)} - \delta^{q^{\sharp}(x)+1} < q'(x) - q(x) < \delta^{q^{\sharp'}(x)} - \delta^{q^{\sharp}(x)+1}.$$

The previous conditions are never satisfied. It thus follows that:

$$q^{\sharp'}(x) \leq q^{\sharp}(x) + 1.$$

Since from Eqn.A.27  $q^{\sharp'}(x) > q^{\sharp}(x)$ , we conclude that:

$$q^{\sharp'}(x) = q^{\sharp}(x) + 1.$$

(b) we assume that  $\beta^{\mathcal{Q}}(q')(x) < \beta^{\mathcal{Q}}(q)(x)$ . We can show, following the same reasoning than in the previous case, that the following equality holds:

$$q^{\sharp'}(x) = q^{\sharp}(x) - 1,$$

which ends the proof of the assertion (3).

(4) Finally let us show that assertion (4) holds.

Let  $r \in \llbracket 1, n \rrbracket$  be a reaction and  $q^{\sharp} \in \mathcal{Q}_R^{\sharp}$  an abstract state. Let  $y$  be a chemical species such that:

$$V_r(y) \neq 0,$$

and:

$$0 \leq q^{\sharp}(y) + \text{sign}(V_r(y)) \leq p.$$

We distinguish between the following two cases:

(a) we assume that  $V_r(y) > 0$ . Let  $q \in \mathcal{Q}_R$  be a concrete state such that for any  $x \in \nu$  we have:

i.

$$q(y) = \delta^{q^\sharp(y)+1} - 1;$$

ii. for any  $x \in \nu \setminus \{y\}$  such that  $V_r(x) > 0$ :

$$\begin{cases} q(x) = \delta^{q^\sharp(x)} & \text{if } q^\sharp(x) \neq 0, \\ q(x) = M_r(x) & \text{if } q^\sharp(x) = 0. \end{cases}$$

Indeed we can define  $q$  as above for  $q^\sharp(x) = 0$  since by assumption  $\delta > M_\infty$ ,

iii. for any  $x \in \nu \setminus \{y\}$  such that  $V_r(x) < 0$ :

$$q(x) = \delta^{q^\sharp(x)+1} - 1,$$

iv. and for any  $x \in \nu \setminus \{y\}$  such that  $V_r(x) = 0$ :

$$\beta^{\mathbb{R}}(q)(x) = q^\sharp(x).$$

First it follows straightforwardly from the definition of the state  $q$  that:

$$\beta^{\mathcal{Q}}(q) = q^\sharp. \quad (\text{A.30})$$

Then by assumption  $\delta > M_\infty$ . Thus for any  $k \geq 1$  we have:

$$\delta^k - 1 \geq M_\infty.$$

It follows from the previous inequality and from the definition of the state  $q$  that for any  $x \in \nu$  we have:

$$q(x) \geq M_r(x). \quad (\text{A.31})$$

Now let  $q'$  be a concrete state defined as follows:

$$q' = q + V_r. \quad (\text{A.32})$$

First from Eqns. A.31 and A.32, and by definition of  $T_R$ , it follows that:

$$(q, r, q') \in T_R. \quad (\text{A.33})$$

Then from Eqn. A.32 it follows that:

i.

$$q(y) = \delta^{q^\sharp(y)+1} - 1 + V_r(y).$$

Since  $V_r(y) > 0$  it follows that:

$$q'(y) \geq \delta^{q^\sharp(y)+1}. \quad (\text{A.34})$$

Moreover by assumption we have:

$$q^\sharp(y) + \text{sign}(V_r(y)) \leq n.$$

Since  $V_r(y) > 0$ , it follows that:

$$q^\sharp(y) \leq n - 1. \quad (\text{A.35})$$

From Eqns. A.34 and A.35, the following inequality is satisfied:

$$\beta(q')(y) \geq q^\sharp(y) + 1. \quad (\text{A.36})$$

Moreover by assumption  $\delta > (M + V)_\infty$ . Since  $M_r(x) \geq 0$  for any  $r$  and  $x$ , we have:

$$\delta > V_\infty. \quad (\text{A.37})$$

From the previous inequality, Eqns. A.30 and A.36, and assumption (3), it thus follows that:

$$\beta(q')(y) = q^\sharp(y) + 1; \quad (\text{A.38})$$

ii. for any  $x \in \nu \setminus \{y\}$  such that  $V_r(x) > 0$  we have:

$$\begin{cases} q'(x) = \delta^{q^\sharp(x)} + V_r(x) & \text{if } q^\sharp(x) \neq 0, \\ q'(x) = M_r(x) + V_r(x) & \text{if } q^\sharp(x) = 0. \end{cases}$$

Let  $x \in \nu \setminus \{y\}$  such that  $V_r(x) > 0$ . First from Eqn. A.37, it follows, if  $q^\sharp(x) \neq 0$ , that:

$$q'(x) < \delta^{q^\sharp(x)+1}. \quad (\text{A.39})$$

Then by assumption  $\delta > (M+V)_\infty$ . Thus it follows, if  $q^\sharp(x) = 0$ , that:

$$q'(x) < \delta. \quad (\text{A.40})$$

From Eqns. A.39 and A.40 we conclude that:

$$\beta(q')(x) = q^\sharp(x); \quad (\text{A.41})$$

iii. for any  $x \in \nu \setminus \{y\}$  such that  $V_r(x) < 0$  we have:

$$q'(x) = \delta^{q^\sharp(x)+1} - 1 + V_r(x). \quad (\text{A.42})$$

Let  $x \in \nu \setminus \{y\}$  such that  $V_r(x) < 0$ . First since  $V_r(x) < 0$  we have:

$$q'(x) < \delta^{q^\sharp(x)+1}. \quad (\text{A.43})$$

Then from Eqn. A.37, it follows, for any  $k \geq 1$ , that:

$$\delta^{k+1} - \delta^k - 1 \geq V_\infty. \quad (\text{A.44})$$

Thus, from Eqns. A.42 and A.44, it follows, if  $q^\sharp(x) > 0$ , that:

$$\delta^{q^\sharp(x)} \leq q'(x). \quad (\text{A.45})$$

Therefore we can conclude from Eqns. A.43 and A.45 that:

$$\beta(q')(x) = q^\sharp(x); \quad (\text{A.46})$$

iv. finally for any  $x \in \nu \setminus \{y\}$  such that  $V_r(x) = 0$ , we have:

$$q'(x) = q(x).$$

Thus it straightforwardly follows that:

$$\beta(q')(x) = q^\sharp(x). \quad (\text{A.47})$$

Therefore from Eqns. A.38, A.41, A.46 and A.47, it follows that:

$$\beta^{\mathcal{Q}}(q') = q^{\sharp}[y \mapsto q^{\sharp}(y) + \text{sign}(V_r(y))]. \quad (\text{A.48})$$

From Eqns. A.50, A.33 and A.48, we can conclude that there exists a transition  $(q, r, q') \in T_R$  such that:

$$\beta^{\mathcal{Q}}(q) = q^{\sharp},$$

and such that:

$$\beta^{\mathcal{Q}}(q') = q^{\sharp}[y \mapsto q^{\sharp}(y) + \text{sign}(V_r(y))].$$

(b) we assume that  $V_r(y) < 0$ . We define the concrete state  $q \in \mathcal{Q}_R$  as in the previous case, except  $q(y)$  that is defined follows:

$$q(y) = \delta^{q^{\sharp}(y)}. \quad (\text{A.49})$$

It straightforwardly follows that:

$$\beta^{\mathcal{Q}}(q) = q^{\sharp}, \quad (\text{A.50})$$

and, for any  $x \in \nu \setminus \{y\}$ , that:

$$M_r(x) \leq q(x). \quad (\text{A.51})$$

Since by assumption we have:

$$0 \leq q^{\sharp}(y) + \text{sign}(V_r(y)),$$

it follows that:

$$q^{\sharp}(y) \geq 1. \quad (\text{A.52})$$

Furthermore by assumption  $\delta > M_{\infty}$ . Thus it follows, from Eqn. A.49, that:

$$M_r(y) \leq q(y). \quad (\text{A.53})$$

From Eqns. A.51 and A.53, the following inequality is satisfied for any  $x \in \nu$ :

$$M_r(x) \leq q(x). \quad (\text{A.54})$$

We then define the concrete state  $q'$  as in the previous case, that is to say:

$$q' = q + V_r. \quad (\text{A.55})$$

From Eqns. A.54 and A.55 and by definition of  $T_R$ , it follows that:

$$(q, r, q') \in T_R. \quad (\text{A.56})$$

Moreover, it further follows, for any  $x \in \nu \setminus \{y\}$ , that:

$$\beta^{\mathcal{Q}}(q')(x) = q^{\sharp}(x). \quad (\text{A.57})$$

By assumption  $V_r(y) < 0$ . Thus from Eqns. A.49 and A.55, the following condition further holds:

$$q'(y) < \delta^{q^\sharp(y)}. \quad (\text{A.58})$$

By Eqn. A.52, we have  $q^\sharp(y) \geq 1$ . It thus follows that:

$$\beta^{\mathcal{Q}}(q')(y) \leq q^\sharp(y) - 1.$$

From Eqn. A.37 and A.50, and assumption (3), it further follows that:

$$\beta^{\mathcal{Q}}(q')(y) = q^\sharp(y) - 1. \quad (\text{A.59})$$

Therefore from Eqns. A.57 and A.59, the following condition holds:

$$\beta^{\mathcal{Q}}(q') = q^\sharp[y \mapsto q^\sharp(y) + \text{sign}(V_r(y))]. \quad (\text{A.60})$$

From Eqns. A.50, A.56 and A.60, we can conclude that there exists a transition  $(q, r, q') \in T_R$  such that:

$$\beta^{\mathcal{Q}}(q) = q^\sharp,$$

and such that:

$$\beta^{\mathcal{Q}}(q') = q^\sharp[y \mapsto q^\sharp(y) + \text{sign}(V_r(y))].$$

□

#### Appendix A.2. Proof of Property 2

We remind the reader of the statement of Property 2, before giving a proof of it.

**Property 2 (mass invariant separation).** *Let:*

- $(a_x)_{x \in \nu} \in \mathbb{N}^\nu \setminus \{0\}^\nu$  be a family of positive integer coefficients (with at least one not equal to 0),
- $b \in \mathbb{N}$  be a non-negative integer coefficient,
- $S$  be the sum of the coefficients  $a_x$  for all chemical species  $x \in \nu$  (i.e.  $S = \sum_{x \in \nu} a_x$ ),
- for any abstract state  $q^\sharp$ ,  $q_{max}^\sharp$  be the maximum element of the following set:

$$\{k \in \llbracket 0, p \rrbracket \mid \exists x \in \nu, a_x > 0 \wedge k = q^\sharp(x)\}.$$

If  $b \geq S\delta^{\beta^{\mathbb{R}}(b)}$ , the following set:

$$\alpha^{\mathcal{Q}} \left( \left\{ q \in \mathcal{Q}_R \mid b = \sum_{x \in \nu} a_x q(x) \right\} \right)$$

is equal to the following set:

$$\{q^\sharp \in \mathcal{Q}_R^\sharp \mid q_{max}^\sharp = \beta^{\mathbb{R}}(b)\}.$$

Otherwise, it is a subset of the following set:

$$\left\{ q^\sharp \in \mathcal{Q}_R^\sharp \mid \beta^{\mathbb{R}}(b) - \left\lceil \frac{S}{\delta} \right\rceil \leq q_{max}^\sharp \leq \beta^{\mathbb{R}}(b) \right\}.$$

PROOF. We take the same notations as in the statement of Property 2.

Let  $q \in \mathcal{Q}_R$  be a concrete state such that the following constraint:

$$b = \sum_{x \in \nu} a_x q(x)$$

is satisfied.

We denote by  $q^\sharp \in \mathcal{Q}_R^\sharp$ , the abstract element  $\beta^{\mathcal{Q}}(q)$ .

By assumption, there exists a chemical species  $z \in \nu$  such that  $a_z \geq 1$ .

We denote by  $q_{max}$  the maximal element of the following set:

$$\{k \in \mathbb{N} \mid \exists x \in \nu, a_x \geq 0 \wedge k = q(x)\}.$$

Since, for any chemical species  $z' \in \nu$ ,  $a_{z'} \geq 0$ , and  $q(z') \geq 0$ , and since  $a_z \geq 1$ , the following inequality:

$$b \geq q_{max}$$

holds.

Since the function  $\beta^{\mathbb{R}}$  is monotonic, it follows that:

$$\beta^{\mathbb{R}}(b) \geq \beta^{\mathbb{R}}(q_{max}).$$

It follows, since  $q_{max}^\sharp = \beta^{\mathbb{R}}(q_{max})$ , that the following inequality:

$$\beta^{\mathbb{R}}(b) \geq q_{max}^\sharp \tag{A.61}$$

is satisfied.

Moreover, since for any chemical species  $z' \in \nu$ ,  $a_{z'} \geq 0$ , and  $0 \leq q(z') \leq q_{max}$ , the following inequality:

$$b \leq \left( \sum_{x \in \nu} a_x \right) q_{max}.$$

holds as well.

It comes the following inequality:

$$b \leq S q_{max}. \tag{A.62}$$

We consider several cases:

(1) We assume that:  $b \geq S \delta^{\beta^{\mathbb{R}}(b)}$ .

Under this assumption, it follows from Eq. A.62 (and since  $S \geq 1$ ) that the following inequality:

$$\delta^{\beta^{\mathbb{R}}(b)} \leq q_{max}$$

is satisfied.

Thus, by definition of  $\beta^{\mathbb{R}}$ , we get that:

$$\beta^{\mathbb{R}}(b) \leq \beta^{\mathbb{R}}(q_{max}).$$

That is to say, since

$$q_{max}^\sharp = \beta^{\mathbb{R}}(q_{max}),$$

that:

$$\beta^{\mathbb{R}}(b) \leq q_{max}^\sharp. \tag{A.63}$$



(2) We assume that  $b < S\delta^{\beta^{\mathbb{R}}(b)}$ .

(a) We also assume that  $b = 0$ .

Since, the following constraint:

$$b = \sum_{x \in \nu} a_x q(x)$$

is satisfied, and for any chemical species  $x \in \nu$ , we have:  $a_x \geq 0$ , it follows that  $q(x) = 0$ , for any chemical species  $x \in \nu$ .

Then, since  $\beta^{\mathbb{R}}(0) = 0$ , it follows that:

$$q_{max}^{\#} = 0. \quad (\text{A.64})$$

(b) We assume that  $b \geq 1$ .

By definition of the function  $\beta^{\mathbb{R}}$  and since  $b \geq 1$ , we know that the following inequality:

$$\delta^{\beta^{\mathbb{R}}(b)} \leq b,$$

is satisfied.

It follows from Eq. A.62, since  $S \geq 1$ , that:

$$\frac{\delta^{\beta^{\mathbb{R}}(b)}}{S} \leq q_{max}.$$

Since, the function  $\beta^{\mathbb{R}}$  is monotonic, it comes the following inequality:

$$\beta^{\mathbb{R}}\left(\frac{\delta^{\beta^{\mathbb{R}}(b)}}{S}\right) \leq \beta^{\mathbb{R}}(q_{max}). \quad (\text{A.65})$$

Now let us show that:

$$\beta^{\mathbb{R}}\left(\frac{\delta^{\beta^{\mathbb{R}}(b)}}{S}\right) \geq \max\left(0, \beta^{\mathbb{R}}(b) - \left\lceil \frac{S}{\delta} \right\rceil\right). \quad (\text{A.66})$$

i. We assume that  $\frac{S}{\delta} \leq 1$ . Since  $\frac{S}{\delta} > 0$  it follows straightforwardly that:

$$S \leq \delta^{\lceil \frac{S}{\delta} \rceil}.$$

ii. We assume that  $\frac{S}{\delta} > 1$ . Then there exists an integer  $k \geq 1$  such that:

$$k < \frac{S}{\delta} \leq k + 1. \quad (\text{A.67})$$

Rearranging the previous inequality, the following inequality holds:

$$S \leq (k + 1)\delta. \quad (\text{A.68})$$

By assumption  $\delta \geq 2$ . Since  $k \geq 1$ , it follows that:

$$k + 1 \leq \delta^k.$$

Multiplying each side of the previous inequality by  $\delta$  it follows that:

$$(k + 1)\delta \leq \delta^{k+1}. \quad (\text{A.69})$$

From Eqns. A.68 and A.69, the following inequality is satisfied:

$$S \leq \delta^{k+1}.$$

It follows straightforwardly from the previous inequality and from Eqn. A.67 that:

$$S \leq \delta^{\lceil \frac{S}{\delta} \rceil}.$$

Therefore the following inequality is satisfied:

$$S \leq \delta^{\lceil \frac{S}{\delta} \rceil}.$$

Multiplying each side of the previous inequality by  $\frac{\delta^{\beta^{\mathbb{R}}(b) - \lceil \frac{S}{\delta} \rceil}}{S}$ , it follows that:

$$\delta^{\beta^{\mathbb{R}}(b) - \lceil \frac{S}{\delta} \rceil} \leq \frac{\delta^{\beta^{\mathbb{R}}(b)}}{S}.$$

We thus conclude from the previous inequality and by definition of the function  $\beta^{\mathbb{R}}$  that Eqn. A.66 holds.

Since:

$$\beta^{\mathbb{R}}(q_{max}) = q_{max}^{\#},$$

it follows from Eqns. A.65 and A.66 that the following inequality:

$$\max\left(0, \beta^{\mathbb{R}}(b) - \left\lceil \frac{S}{\delta} \right\rceil\right) \leq q_{max}^{\#}$$

is satisfied.

Since the following inequality:

$$\beta^{\mathbb{R}}(b) - \left\lceil \frac{S}{\delta} \right\rceil \leq \max\left(0, \beta^{\mathbb{R}}(b) - \left\lceil \frac{S}{\delta} \right\rceil\right),$$

is satisfied, we can conclude that:

$$\beta^{\mathbb{R}}(b) - \left\lceil \frac{S}{\delta} \right\rceil \leq q_{max}^{\#}. \quad (\text{A.70})$$

□

### Appendix A.3. Proof of Property 3

We remind the reader of the statement of Property 3, before giving a proof of it.

**Property 3 (Decision procedure).** *Let  $(q^{\#}, x_{\ddagger}, r) \in \text{esc}$ . We have  $q^{\#}(x) \neq p$  and there exists a function  $w \in \mathbb{N}^{\llbracket 1, n \rrbracket}$  such that:*

- (i)  $w(r) > 0$ ,
- (ii)  $\delta^{q^{\#}(x)} + V_{\infty} + V_w(x) \geq \delta^{q^{\#}(x)+1}$ ,
- (iii)  $\forall x' \in \nu$ ,  $q^{\#}(x') \neq p \Rightarrow \delta^{q^{\#}(x')+1} + V_w(x') > 0$ ,

where, for any chemical species  $x' \in \nu$ ,  $V_w(x')$  denotes the value of the expression  $\sum_{1 \leq r' \leq n} w(r') V_{r'}(x')$ .

PROOF. We take the same notations as in the statement of Property 3.

Let  $(q^\sharp, x_\ddagger, r) \in \text{esc}$ . Then, by definition of *esc*, there exists a concrete trace  $\tau \in \mathcal{T}_{R, \mathcal{Q}_R}$  which satisfies:

- (i)  $\beta^{\mathcal{Q}}(\text{first}(\tau)) = q^\sharp$ ,
- (ii)  $\text{first}(\tau) \models x_\ddagger$ ,
- (iii)  $\beta^{\mathcal{Q}}(\text{first}(\tau))(x) < \beta^{\mathcal{Q}}(\text{final}(\tau))(x)$ ,
- (iv)  $V_r(x) > 0$ ,
- (v) there exists a transition in  $\tau$  with the label  $r$ .

First it follows straightforwardly from conditions (i) and (iii) of the definition of  $\tau$  that:

$$q^\sharp(x) \neq p.$$

Then let  $w \in \mathbb{N}^{\llbracket 1, n \rrbracket}$  be the vector defined as follows:

$$w = (w_1, w_2, \dots, w_n),$$

where, for all  $i$  between 1 and  $n$ ,  $w_i$  is the number of occurrences of the reaction  $i$  in the trace  $\tau$ .

There exists a transition in  $\tau$  with the label  $r$  (condition (v) on  $\tau$ ). Thus we have:

$$w(r) \geq 1.$$

Then summing the equations which update the number of instances of the chemical species for each transition composing the trace  $\tau$ , we get for all chemical species  $x'$  in  $\nu$ :

$$0 \leq \text{first}(\tau)(x') + V_w(x') = \text{final}(\tau)(x'), \quad (\text{A.71})$$

where:

$$V_w(x') = \sum_{1 \leq r' \leq n} w(r') V_{r'}(x').$$

Moreover we have  $\text{first}(\tau) \models x_\ddagger$  (condition (ii) on  $\tau$ ). Thus it follows that:

(1) either:

$$\delta^{q^\sharp(x)} \leq \text{first}(\tau)(x) \leq \delta^{q^\sharp(x)} + V_\infty.$$

(2) or there is no concrete trace  $\tau$  in  $\mathcal{T}_{R, \{\text{first}(\tau)\}}$  such that:

$$\beta^{\mathbb{R}}(\text{final}(\tau)(x)) > \beta^{\mathbb{R}}(\text{first}(\tau)(x)).$$

From condition (iii) of the definition of  $\tau$ , the previous statement (2) does not hold. Therefore the previous statement (1) holds and it follows in particular that:

$$\text{first}(\tau)(x) \leq \delta^{q^\sharp(x)} + V_\infty. \quad (\text{A.72})$$

We also have  $\beta^{\mathcal{Q}}(\text{first}(\tau))(x) < \beta^{\mathcal{Q}}(\text{final}(\tau))(x)$  (condition (iii) on  $\tau$ ). Thus:

$$\delta^{q^\sharp(x)+1} \leq \text{final}(\tau)(x). \quad (\text{A.73})$$

Therefore from Eqns. A.71, A.72 and A.73 we get:

$$\delta^{q^\sharp(x)+1} \leq \delta^{q^\sharp(x)} + V_\infty + V_w(x).$$

Furthermore we have  $\beta^\mathcal{Q}(\text{first}(\tau)) = q^\sharp$  (condition (i) on  $\tau$ ). Thus for all  $x'$  in  $\nu$  such that  $q(x') \neq p$ , we have:

$$\text{first}(\tau)(x') < \delta^{q^\sharp(x')+1}. \quad (\text{A.74})$$

Therefore from Eqns. A.71 and A.74, for all  $x'$  in  $\nu$  such that  $q(x') \neq p$ , we have:

$$0 < \delta^{q^\sharp(x')+1} + V_w(x'),$$

which ends the proof.  $\square$

#### Appendix A.4. Proof of Property 4

We remind the reader of the statement of Property 4, before giving a proof of it.

**Property 4 (time scale separation).** *For any integer  $r' \in \llbracket 1, n \rrbracket$  and any abstract state  $q^\sharp \in \mathcal{Q}_R^\sharp$ , we denote by  $k^\sharp(r', q^\sharp)$  the set of real values that is defined as follows:*

$$k^\sharp(r', q^\sharp) \triangleq \alpha^\mathbb{R} \left( \bigcup \{k_{r'}(q) \mid q \in \gamma^\mathcal{Q}(\{q^\sharp\})\} \right),$$

and introduce the abstract values  $k_{lb}^\sharp(r', q^\sharp)$  and  $k_{ub}^\sharp(r', q^\sharp)$  that are defined as follows:

$$k_{lb}^\sharp(r', q^\sharp) \triangleq \min k^\sharp(r', q^\sharp),$$

and

$$k_{ub}^\sharp(r', q^\sharp) \triangleq \max k^\sharp(r', q^\sharp).$$

Let  $(q^\sharp, r)$  be a pair in  $\mathcal{Q}_R^\sharp \times \llbracket 1, n \rrbracket$ .

If both following conditions are satisfied:

- (1)  $k_{ub}^\sharp(r, q^\sharp) \neq p$ ,
- (2) and  $\left( \delta^{k_{ub}^\sharp(r, q^\sharp)+1}, \delta^{\max\{k_{lb}^\sharp(r', q^\sharp) \mid r' \in \llbracket 1, n \rrbracket\}} \right) \in \text{Sep}$ ,

then, for any state  $q \in \gamma^\mathcal{Q}(\{q^\sharp\})$ , there exists an integer  $r' \in \llbracket 1, n \rrbracket$  such that the following condition:

$$(k_r(q), k_{r'}(q)) \subseteq \text{Sep}$$

is satisfied as well.

PROOF. We take the same notations as in the statement of Property 4.

We assume that:

- (1)  $k_{ub}^\sharp(r, q^\sharp) \neq p$ ,
- (2) and  $\left( \delta^{k_{ub}^\sharp(r, q^\sharp)+1}, \delta^{\max\{k_{lb}^\sharp(r', q^\sharp) \mid r' \in \llbracket 1, n \rrbracket\}} \right) \in \text{Sep}$ .

Let  $r''$  be an integer in  $\llbracket 1, n \rrbracket$  such that:

$$k_{lb}^\#(r'', q^\#) = \max\{k_{lb}^\#(r', q^\#) \mid r' \in \llbracket 1, n \rrbracket\}.$$

Let  $q \in \gamma^\mathcal{Q}(\{q^\#\})$ ,  $x \in k_r(q)$ , and  $x' \in k_{r''}(q)$ .

- We know that:

$$x \in k_r(q).$$

It comes that the following inequality:

$$x \leq \text{lub } k_r(q)$$

is satisfied.

Then, we have  $q \in \gamma^\mathcal{Q}(\{q^\#\})$ , thus the following inclusion:

$$k_r(q) \subseteq \bigcup \{k_r(q') \mid q' \in \gamma^\mathcal{Q}(\{q^\#\})\}$$

is satisfied.

Since  $(\alpha^\mathcal{Q}, \gamma^\mathcal{Q})$  is a Galois connection, it follows that:

$$\bigcup \{k_r(q') \mid q' \in \gamma^\mathcal{Q}(\{q^\#\})\} \subseteq \gamma^\mathcal{Q} \left( \alpha^\mathcal{Q} \left( \bigcup \{k_r(q') \mid q' \in \gamma^\mathcal{Q}(\{q^\#\})\} \right) \right).$$

As a consequence, the following inequality:

$$\text{lub } k_r(q) \leq \text{lub } \gamma^\mathcal{Q} \left( \alpha^\mathcal{Q} \left( \bigcup \{k_r(q') \mid q' \in \gamma^\mathcal{Q}(\{q^\#\})\} \right) \right)$$

holds.

That is to say that the following inequality:

$$\text{lub } k_r(q) \leq \text{lub } \gamma^\mathcal{Q}(k^\#(r, q^\#))$$

is satisfied.

Then, since,  $k_{ub}^\#(r', q^\#) \neq p$ , the following equality:

$$\gamma^\mathcal{Q}(k^\#(r, q^\#)) = \{z \in \mathbb{R}_{\geq 0} \mid \delta^{k_{lb}^\#(r, q^\#)} \leq z < \delta^{k_{ub}^\#(r, q^\#)+1}\},$$

is satisfied, and we can conclude that the following inequality:

$$x \leq \delta^{k_{ub}^\#(r, q^\#)+1} \tag{A.75}$$

is satisfied

- We know that:

$$x' \in k_{r''}(q).$$

It follows that the following inequality

$$x' \geq \text{glb } k_{r''}(q)$$

is satisfied.

Then, we have  $q \in \gamma^{\mathcal{Q}}(\{q^\sharp\})$ , thus the following inclusion:

$$k_{r''}(q) \subseteq \bigcup \{k_{r''}(q') \mid q' \in \gamma^{\mathcal{Q}}(\{q^\sharp\})\}$$

is satisfied.

Since  $(\alpha^{\mathcal{Q}}, \gamma^{\mathcal{Q}})$  is a Galois connection, it follows that:

$$\bigcup \{k_{r''}(q') \mid q' \in \gamma^{\mathcal{Q}}(\{q^\sharp\})\} \subseteq \gamma^{\mathcal{Q}}\left(\alpha^{\mathcal{Q}}\left(\bigcup \{k_{r''}(q') \mid q' \in \gamma^{\mathcal{Q}}(\{q^\sharp\})\}\right)\right).$$

As a consequence, the following inequality:

$$glb \gamma^{\mathcal{Q}}\left(\alpha^{\mathcal{Q}}\left(\bigcup \{k_{r''}(q') \mid q' \in \gamma^{\mathcal{Q}}(\{q^\sharp\})\}\right)\right) \leq glb k_{r''}(q)$$

holds.

That is to say that the following inequality:

$$glb \gamma^{\mathcal{Q}}(k^\sharp(r'', q^\sharp)) \leq glb k_{r''}(q)$$

is satisfied.

But, we have:

$$\gamma^{\mathcal{Q}}(k^\sharp(r'', q^\sharp)) = \{z \in \mathbb{R}_{\geq 0} \mid \delta^{k_{ib}^\sharp(r'', q^\sharp)} \leq z < \delta^{k_{ub}^\sharp(r'', q^\sharp)+1}\}.$$

We can conclude that the following inequality is satisfied:

$$\delta^{max\{k_{ib}^\sharp(r', q^\sharp) \mid r' \in \llbracket 1, n \rrbracket\}} \leq x' \quad (\text{A.76})$$

Then, since:

$$\left(\delta^{k_{ub}^\sharp(r, q^\sharp)+1}, \delta^{max\{k_{ib}^\sharp(r', q^\sharp) \mid r' \in \llbracket 1, n \rrbracket\}}\right) \in Sep$$

It follows from Eqns. A.75 and A.76, and by definition of the set *Sep*, that the pair  $(x, x')$  belongs to the set *Sep* as well.  $\square$

#### Appendix A.5. Proof of Property 5

We remind the reader of the statement of Property 5, before giving a proof of it.

**Property 5 (time scale separation with mass-action law kinetics).** *We assume that for any integer  $r' \in \llbracket 1, n \rrbracket$ , there exist two non negative real numbers  $\Gamma_{lb}(r')$  and  $\Gamma_{ub}(r')$ , and a function  $K_{r'}$  mapping each state  $q \in \mathcal{Q}_R$  into a non negative integer  $K_{r'}(q) \in \mathbb{N}$  such that the following constraint is satisfied:*

$$k_{r'}(q) \subseteq \{\Gamma K_{r'}(q) \mid \Gamma \in \mathbb{R}_{\geq 0}, \Gamma_{lb}(r') \leq \Gamma \leq \Gamma_{ub}(r')\}.$$

For any integer  $r' \in \llbracket 1, n \rrbracket$  and any abstract state  $q^\sharp \in \mathcal{Q}_R^\sharp$ , we denote by  $K^\sharp(r', q^\sharp)$  the set of real values that is defined as follows:

$$K^\sharp(r', q^\sharp) \triangleq \alpha^{\mathbb{R}}\left(\bigcup \{K_{r'}(q) \mid q \in \gamma^{\mathcal{Q}}(\{q^\sharp\})\}\right),$$

and introduce the abstract values  $K_{lb}^\sharp(r', q^\sharp)$  and  $K_{ub}^\sharp(r', q^\sharp)$  that are defined as follows:

$$K_{lb}^\sharp(r', q^\sharp) \triangleq \min K^\sharp(r', q^\sharp),$$

and

$$K_{ub}^\sharp(r', q^\sharp) \triangleq \max K^\sharp(r', q^\sharp).$$

Let  $(q^\sharp, r)$  be a pair in  $\mathcal{Q}_R^\sharp \times \llbracket 1, n \rrbracket$ .

If both following conditions are satisfied:

$$(1) K_{ub}^\sharp(r, q^\sharp) \neq p,$$

$$(2) \text{ and } \left( \Gamma_{ub}(r)(\delta^{K_{ub}^\sharp(r, q^\sharp)+1} - 1), \max \left\{ \Gamma_{lb}(r') \delta^{K_{lb}^\sharp(r', q^\sharp)} \mid r' \in \llbracket 1, n \rrbracket \right\} \right) \in \text{Sep},$$

then, for any state  $q \in \gamma^\mathcal{Q}(\{q^\sharp\})$ , there exists an integer  $r' \in \llbracket 1, n \rrbracket$  such that the following condition:

$$(k_r(q), k_{r'}(q)) \subseteq \text{Sep}$$

is satisfied as well.

PROOF. We take the same notations as in the statement of Property 5.

We assume that:

$$(1) K_{ub}^\sharp(r, q^\sharp) \neq p,$$

$$(2) \text{ and } \left( \Gamma_{ub}(r)(\delta^{K_{ub}^\sharp(r, q^\sharp)+1} - 1), \max \left\{ \Gamma_{lb}(r') \delta^{K_{lb}^\sharp(r', q^\sharp)} \mid r' \in \llbracket 1, n \rrbracket \right\} \right) \in \text{Sep}.$$

Let  $r''$  be an integer in  $\llbracket 1, n \rrbracket$  such that:

$$\Gamma_{lb}(r'') \delta^{K_{lb}^\sharp(r'', q^\sharp)} = \max \left\{ \Gamma_{lb}(r') \delta^{K_{lb}^\sharp(r', q^\sharp)} \mid r' \in \llbracket 1, n \rrbracket \right\}.$$

Let  $q \in \gamma^\mathcal{Q}(\{q^\sharp\})$ ,  $x \in k_r(q)$ , and  $x' \in k_{r''}(q)$ .

- We know that:

$$x \in k_r(q).$$

It follows that the following inequality

$$x \leq \text{lub } k_r(q)$$

is satisfied.

Then, we have  $q \in \gamma^\mathcal{Q}(\{q^\sharp\})$ , thus the following inclusion:

$$k_r(q) \subseteq \bigcup \{k_r(q') \mid q' \in \gamma^\mathcal{Q}(\{q^\sharp\})\}$$

is satisfied.

By assumption, the following constraint:

$$k_r(q') \subseteq \{\Gamma K_r(q') \mid \Gamma_{lb}(r) \leq \Gamma \leq \Gamma_{ub}(r)\}$$

is satisfied, for any concrete state  $q' \in \mathcal{Q}_R$ . It follows that the following inclusion

$$k_r(q) \subseteq \bigcup \left\{ \Gamma K_r(q') \mid \begin{array}{l} \Gamma_{lb}(r) \leq \Gamma \leq \Gamma_{ub}(r), \\ q' \in \gamma^\mathcal{Q}(\{q^\sharp\}) \end{array} \right\}$$

holds as well.

Thus, we can deduce that the following inequality:

$$\text{lub } k_r(q) \leq \left( \text{lub} \bigcup \{K_r(q') \mid q' \in \gamma^{\mathcal{Q}}(\{q\})\} \right) \Gamma_{ub}$$

is satisfied.

Since  $(\alpha^{\mathcal{Q}}, \gamma^{\mathcal{Q}})$  is a Galois connection, it follows that:

$$\{K_r(q') \mid q' \in \gamma^{\mathcal{Q}}(\{q\})\} \subseteq \gamma^{\mathcal{Q}} \left( \alpha^{\mathcal{Q}} \left( \bigcup \{K_r(q') \mid q' \in \gamma^{\mathcal{Q}}(\{q^{\#}\})\} \right) \right).$$

Moreover, since the function  $K_r$  ranges over the fields of the non negative integer numbers, we get that:

$$\bigcup \{K_r(q') \mid q' \in \gamma^{\mathcal{Q}}(\{q\})\} \subseteq \mathbb{N} \cap \gamma^{\mathcal{Q}} \left( \alpha^{\mathcal{Q}} \left( \bigcup \{K_r(q') \mid q' \in \gamma^{\mathcal{Q}}(\{q^{\#}\})\} \right) \right).$$

As a consequence, the following inequality:

$$K_r(q) \leq \max \left\{ n \in \mathbb{N} \mid n \in \gamma^{\mathcal{Q}} \left( \alpha^{\mathcal{Q}} \left( \bigcup \{K_r(q') \mid q' \in \gamma^{\mathcal{Q}}(\{q\})\} \right) \right) \right\}$$

holds.

That is to say that the following inequality:

$$K_r(q) \leq \max \{ n \in \mathbb{N} \mid n \in \gamma^{\mathcal{Q}}(K_r^{\#}(q^{\#})) \}$$

is satisfied.

Then, since the following equation is satisfied:

$$\gamma^{\mathcal{Q}}(K_r^{\#}(r, q^{\#})) = \{z \in \mathbb{R}_{\geq 0} \mid \delta^{k_{ib}^{\#}(r, q^{\#})} \leq z < \delta^{k_{ub}^{\#}(r, q^{\#})+1}\},$$

we can conclude that the following inequality:

$$x \leq \delta^{k_{ub}^{\#}(r, q^{\#})+1} - 1 \tag{A.77}$$

is satisfied.

- We know that:

$$x' \in k_{r''}(q).$$

It follows that the following inequality:

$$\text{glb } k_{r''}(q) \leq x'$$

is satisfied.

Then, we have  $q \in \gamma^{\mathcal{Q}}(\{q^{\#}\})$ , thus the following inclusion:

$$k_{r''}(q) \subseteq \bigcup \{k_r(q') \mid q' \in \gamma^{\mathcal{Q}}(\{q^{\#}\})\}$$

is satisfied.

By assumption, the following constraint:

$$k_{r''}(q') \subseteq \{\Gamma K_{r''}(q') \mid \Gamma_{lb}(r) \leq \Gamma \leq \Gamma_{ub}(r)\}$$



is satisfied, for any concrete state  $q' \in \mathcal{Q}_R$ . It follows that the following inclusion:

$$k_{r''}(q) \subseteq \bigcup \left\{ \Gamma_{K_{r''}}(q') \mid \begin{array}{l} \Gamma_{lb}(r) \leq \Gamma \leq \Gamma_{ub}(r), \\ q' \in \gamma^{\mathcal{Q}}(\{q\}) \end{array} \right\}$$

holds as well.

Thus, we can deduce that the following inequality:

$$\left( glb \bigcup \{K_{r''}(q') \mid q' \in \gamma^{\mathcal{Q}}(\{q\})\} \right) \Gamma_{lb} \leq glb k_{r''}(q)$$

is satisfied.

Since  $(\alpha^{\mathcal{Q}}, \gamma^{\mathcal{Q}})$  is a Galois connection, it follows that:

$$\{K_{r''}(q') \mid q' \in \gamma^{\mathcal{Q}}(\{q\})\} \subseteq \gamma^{\mathcal{Q}}\left(\alpha^{\mathcal{Q}}\left(\bigcup \{K_{r''}(q') \mid q' \in \gamma^{\mathcal{Q}}(\{q^{\#})\}\}\right)\right).$$

As a consequence, the following inequality:

$$glb \gamma^{\mathcal{Q}}\left(\alpha^{\mathcal{Q}}\left(\bigcup \{K_{r''}(q') \mid q' \in \gamma^{\mathcal{Q}}(\{q^{\#})\}\}\right)\right) \leq K_r(q)$$

holds.

That is to say that the following inequality:

$$glb \gamma^{\mathcal{Q}}(K_r^{\#}(q^{\#})) \leq K_{r''}(q)$$

is satisfied.

Then, since the following equality is satisfied:

$$\gamma^{\mathcal{Q}}(K_r^{\#}(r'', q^{\#})) = \{z \in \mathbb{R}_{\geq 0} \mid \delta_{lb}^{k_{lb}^{\#}(r'', q^{\#})} \leq z < \delta_{ub}^{k_{ub}^{\#}(r'', q^{\#})+1}\},$$

we can conclude that the following inequality:

$$\Gamma_{lb}(r'') \delta_{ub}^{k_{ub}^{\#}(r'', q^{\#})} \leq x' \tag{A.78}$$

is satisfied.

Then, since:

$$\left( \Gamma_{ub}(r) (\delta_{ub}^{k_{ub}^{\#}(r, q^{\#})+1} - 1), \Gamma_{lb}(r'') \delta_{ub}^{k_{ub}^{\#}(r'', q^{\#})} \right) \in Sep,$$

it follows from Eqns. A.77 and A.78, and by definition of the set *Sep*, that the pair  $(x, x')$  belongs to the set *Sep* as well. □

#### Appendix A.6. Proof of Property 6

We remind the reader of Property 6, before giving a proof of it.

**Property 6 (abstract kinetic function in the case of mass-action law).**

We assume that the kinetic function  $k_r$  follows the mass-action stochastic law (with imprecise kinetic constants), that is to say, for any reaction  $r$  in  $\llbracket 1, n \rrbracket$  there exist two non negative real numbers  $a_{lb}(r)$  and  $a_{ub}(r)$  such that:

$$k_r(q) \subseteq \{\Gamma K_r(q) \mid \Gamma \in \mathbb{R}_{\geq 0}, \Gamma_{lb}(r) \leq \Gamma \leq \Gamma_{ub}(r)\},$$

where  $K_r$  is the function mapping each state  $q \in \mathcal{Q}_R$  into the non negative integer  $K_r(q) \in \mathbb{N}$  that is defined as follows:

$$K_r(q) \triangleq \prod_{x \in \nu} \left( \frac{q(x)!}{(q(x) - M_r(x))!} \right),$$

and  $\Gamma_{lb}(r)$  and  $\Gamma_{ub}(r)$  are two non-negative real numbers defined as follows:

$$\Gamma_{lb}(r) \triangleq \frac{a_{lb}(r)}{\prod_{x \in \nu} M_r(x)!}, \quad \Gamma_{ub}(r) \triangleq \frac{a_{ub}(r)}{\prod_{x \in \nu} M_r(x)!}.$$

We further assume that  $\delta > 3$ .

Then:

- (1) If  $r$  is monomolecular of reactant  $x_0$ , that is to say if  $M_r(x_0) = 1$  and  $M_r(x) = 0$  for any chemical species  $x \in \nu \setminus \{x_0\}$ , we have:

$$\begin{cases} K_{lb}^\sharp(r, q^\sharp) &= q^\sharp(x_0); \\ K_{ub}^\sharp(r, q^\sharp) &= q^\sharp(x_0). \end{cases}$$

- (2) If  $r$  is bimolecular of reactant  $x_0$ , that is to say if  $M_r(x_0) = 2$  and  $M_r(x) = 0$  for any chemical species  $x \in \nu \setminus \{x_0\}$ , we have:

$$\begin{cases} K_{lb}^\sharp(r, q^\sharp) &= \min(\max(0, 2q^\sharp(x_0) - 1), p); \\ K_{ub}^\sharp(r, q^\sharp) &= \min(2q^\sharp(x_0) + 1, p). \end{cases}$$

- (3) If  $r$  is bimolecular of reactants  $x_1$  and  $x_2$ , that is to say if  $M_r(x_1) = 1$ ,  $M_r(x_2) = 1$  and  $M_r(x) = 0$  for any chemical species  $x \in \nu \setminus \{x_1, x_2\}$ , we have:

$$\begin{cases} K_{lb}^\sharp(r, q^\sharp) &= \begin{cases} 0 & \text{whenever } q^\sharp(x_1)q^\sharp(x_2) = 0, \\ \min(q^\sharp(x_1) + q^\sharp(x_2), p) & \text{whenever } q^\sharp(x_1)q^\sharp(x_2) \neq 0; \end{cases} \\ K_{ub}^\sharp(r, q^\sharp) &= \min(q^\sharp(x_1) + q^\sharp(x_2) + 1, p). \end{cases}$$

PROOF. We take the same notations as in the statement of Property 6.

- (1) We start by considering a monomolecular reaction  $r$  of reactant  $x_0$ .

By assumption on the kinetic function  $k_r$ , for any state  $q \in \mathcal{Q}_R$ , the following equality is satisfied:

$$K_r(q) = q(x_0). \quad (\text{A.79})$$

We then distinguish between the following cases:

(a) We assume that  $q^\sharp(x_0) = 0$ . It follows that:

$$\gamma^{\mathcal{Q}}(\{q^\sharp\})(x_0) = \llbracket 0, \delta \rrbracket.$$

Thus from Eqn. A.79, the following equality is satisfied:

$$\bigcup \{K_r(q) \mid q \in \gamma^{\mathcal{Q}}(\{q^\sharp\})\} = \llbracket 0, \delta \rrbracket.$$

Applying the abstraction function  $\alpha^v$  to the previous equality, the following equality holds:

$$K^\sharp(r, q^\sharp) = \{0\}.$$

We can thus conclude that the upper and lower bounds of  $K^\sharp(r, q^\sharp)$  satisfy the following equalities:

$$\begin{cases} K_{lb}^\sharp(r, q^\sharp) &= 0; \\ K_{ub}^\sharp(r, q^\sharp) &= 0. \end{cases}$$

(b) We then assume that  $0 < q^\sharp(x_0) < p$ . It follows that:

$$\gamma^{\mathcal{Q}}(\{q^\sharp\})(x_0) = \llbracket \delta^{q^\sharp(x_0)}, \delta^{q^\sharp(x_0)+1} \rrbracket.$$

Thus from Eqn. A.79, the following equality is satisfied:

$$\bigcup \{K_r(q) \mid q \in \gamma^{\mathcal{Q}}(\{q^\sharp\})\} = \llbracket \delta^{q^\sharp(x_0)}, \delta^{q^\sharp(x_0)+1} \rrbracket.$$

Applying the abstraction function  $\alpha^v$  to the previous equality it follows that:

$$K^\sharp(r, q^\sharp) = \{q^\sharp(x_0)\}.$$

We can thus conclude that the following equalities are satisfied:

$$\begin{cases} K_{lb}^\sharp(r, q^\sharp) &= q^\sharp(x_0); \\ K_{ub}^\sharp(r, q^\sharp) &= q^\sharp(x_0). \end{cases}$$

(c) Finally we assume that  $q^\sharp(x_0) = p$ . It follows that:

$$\gamma^{\mathcal{Q}}(\{q^\sharp\})(x_0) = \llbracket \delta^p, +\infty \rrbracket.$$

Thus from Eqn. A.79, the following equality is satisfied:

$$\bigcup \{K_r(q) \mid q \in \gamma^{\mathcal{Q}}(\{q^\sharp\})\} = \llbracket \delta^p, +\infty \rrbracket.$$

Applying the abstraction function  $\alpha^v$  to the previous equality it follows that:

$$K^\sharp(r, q^\sharp) = \{p\}.$$

We can thus conclude that the following equalities are satisfied:

$$\begin{cases} K_{lb}^\sharp(r, q^\sharp) &= p; \\ K_{ub}^\sharp(r, q^\sharp) &= p. \end{cases}$$

- (2) Let us now consider a bimolecular reaction  $r$  of reactant  $x_0$ . By assumption, for any state  $q \in \mathcal{Q}_R$ , the following equality is satisfied:

$$K_r(q) = q(x_0) (q(x_0) - 1). \quad (\text{A.80})$$

We distinguish between the following cases:

- (a) We assume that  $q^\sharp(x_0) = 0$ . It follows that:

$$\gamma^\mathcal{Q}(\{q^\sharp\})(x_0) = \llbracket 0, \delta \llbracket.$$

Thus from Eqn. A.80, it follows that the set  $\bigcup\{K_r(q) \mid q \in \gamma^\mathcal{Q}(\{q^\sharp\})\}$  satisfies the following constraints:

$$\min(\bigcup\{K_r(q) \mid q \in \gamma^\mathcal{Q}(\{q^\sharp\})\}) = 0, \quad (\text{A.81})$$

and:

$$\max(\bigcup\{K_r(q) \mid q \in \gamma^\mathcal{Q}(\{q^\sharp\})\}) = (\delta - 1)(\delta - 2). \quad (\text{A.82})$$

First it follows from Eqn. A.81 that:

$$\beta^\mathbb{R}(\min(\bigcup\{K_r(q) \mid q \in \gamma^\mathcal{Q}(\{q^\sharp\})\})) = 0. \quad (\text{A.83})$$

Then by assumption  $\delta > 3$ . Thus it follows from an analysis of the function  $\delta \mapsto (\delta - 1)(\delta - 2) - \delta$  that:

$$\delta \leq (\delta - 1)(\delta - 2).$$

Moreover the following inequality straightforwardly holds:

$$(\delta - 1)(\delta - 2) < \delta^2.$$

From the previous two inequalities the following constraint is thus satisfied:

$$(\delta - 1)(\delta - 2) \in \llbracket \delta, \delta^2 \llbracket. \quad (\text{A.84})$$

Therefore it follows from the previous constraint and from Eqn. A.82 that:

$$\beta^\mathbb{R}(\max(\bigcup\{K_r(q) \mid q \in \gamma^\mathcal{Q}(\{q^\sharp\})\})) = 1. \quad (\text{A.85})$$

Moreover the function  $\beta^v$  is monotonic. Thus for any  $x \in \bigcup\{K_r(q) \mid q \in \gamma^\mathcal{Q}(\{q^\sharp\})\}$  the following constraint holds:

$$\beta^v(\min(\bigcup\{K_r(q) \mid q \in \gamma^\mathcal{Q}(\{q^\sharp\})\})) \leq \beta^v(x), \quad (\text{A.86})$$

and:

$$\beta^v(x) \leq \beta^v(\max(\bigcup\{K_r(q) \mid q \in \gamma^\mathcal{Q}(\{q^\sharp\})\})). \quad (\text{A.87})$$

Thus it follows from Eqns. A.83, A.85, A.86 and A.87 that:

$$K^\sharp(r, q^\sharp) = \llbracket 0, 1 \llbracket.$$

We can then conclude that the following equalities are satisfied:

$$\begin{cases} K_{lb}^\sharp(r, q^\sharp) & = 0; \\ K_{ub}^\sharp(r, q^\sharp) & = 1. \end{cases}$$

(b) We assume that  $0 < q^\sharp(x_0) < p$ . It follows that:

$$\gamma^{\mathcal{Q}}(\{q^\sharp\})(x_0) = \llbracket \delta^{q^\sharp(x_0)}, \delta^{q^\sharp(x_0)+1} \rrbracket.$$

Thus from Eqn. A.80, the set  $\bigcup\{K_r(q) \mid q \in \gamma^{\mathcal{Q}}(\{q^\sharp\})\}$  satisfies the following constraints:

$$\min(\bigcup\{K_r(q) \mid q \in \gamma^{\mathcal{Q}}(\{q^\sharp\})\}) = \delta^{q^\sharp(x_0)}(\delta^{q^\sharp(x_0)} - 1), \quad (\text{A.88})$$

and:

$$\max(\bigcup\{K_r(q) \mid q \in \gamma^{\mathcal{Q}}(\{q^\sharp\})\}) = (\delta^{q^\sharp(x_0)+1} - 1)(\delta^{q^\sharp(x_0)+1} - 2). \quad (\text{A.89})$$

Since  $\delta \geq 2$  and  $q^\sharp(x_0) \geq 1$ , the following inequality holds:

$$1 \leq \delta^{q^\sharp(x_0)-1}(\delta - 1).$$

Rearranging the previous inequality, we get:

$$\delta^{q^\sharp(x_0)-1} \leq \delta^{q^\sharp(x_0)} - 1.$$

Multiplying each side of the previous inequality by  $\delta^{q^\sharp(x_0)}$ , it follows that:

$$\delta^{2q^\sharp(x_0)-1} \leq \delta^{q^\sharp(x_0)}(\delta^{q^\sharp(x_0)} - 1). \quad (\text{A.90})$$

Moreover, the following inequality straightforwardly holds:

$$\delta^{q^\sharp(x_0)} - 1 < \delta^{q^\sharp(x_0)}.$$

Multiplying each side of the previous inequality by  $\delta^{q^\sharp(x_0)}$ , it follows that:

$$\delta^{q^\sharp(x_0)}(\delta^{q^\sharp(x_0)} - 1) < \delta^{2q^\sharp(x_0)}. \quad (\text{A.91})$$

From Eqns. A.90 and A.91, the following constraint is thus satisfied:

$$\delta^{q^\sharp(x_0)}(\delta^{q^\sharp(x_0)} - 1) \in \llbracket \delta^{2q^\sharp(x_0)-1}, \delta^{2q^\sharp(x_0)} \rrbracket. \quad (\text{A.92})$$

Then let us show that the following constraints hold:

$$(\delta^{q^\sharp(x_0)+1} - 1)(\delta^{q^\sharp(x_0)+1} - 2) \in \llbracket \delta^{2q^\sharp(x_0)+1}, \delta^{2q^\sharp(x_0)+2} \rrbracket. \quad (\text{A.93})$$

i. First the following inequality straightforwardly holds:

$$(\delta^{q^\sharp(x_0)+1} - 1)(\delta^{q^\sharp(x_0)+1} - 2) < \delta^{2(q^\sharp(x_0)+1)}. \quad (\text{A.94})$$

ii. Then let us show that:

$$I(\delta, q^\sharp(x_0)) \geq 0, \quad (\text{A.95})$$

where  $I(\delta, q^\sharp(x_0))$  is defined as follows:

$$I(\delta, q^\sharp(x_0)) = (\delta^{q^\sharp(x_0)+1} - 1)(\delta^{q^\sharp(x_0)+1} - 2) - \delta^{2q^\sharp(x_0)+1}.$$

First the following inequality is straightforwardly satisfied:

$$I(\delta, q^\sharp(x_0)) \geq (\delta^{q^\sharp(x_0)+1} - 2)^2 - \delta^{2q^\sharp(x_0)+1}.$$

Factorizing the right hand side of the previous inequality, it follows that:

$$I(\delta, q^\sharp(x_0)) \geq (\delta^{q^\sharp(x_0)+1} - 2 + \delta^{\frac{2q^\sharp(x_0)+1}{2}})(\delta^{q^\sharp(x_0)+1} - 2 - \delta^{\frac{2q^\sharp(x_0)+1}{2}}). \quad (\text{A.96})$$

Since by assumption  $\delta > 3$ , it follows that:

$$\delta^{q^\sharp(x_0)+1} - 2 + \delta^{\frac{2q^\sharp(x_0)+1}{2}} \geq 0. \quad (\text{A.97})$$

Moreover we have by factorization:

$$\delta^{q^\sharp(x_0)+1} - 2 - \delta^{\frac{2q^\sharp(x_0)+1}{2}} = \delta^{\frac{2q^\sharp(x_0)+1}{2}}(\delta^{\frac{1}{2}} - 1) - 2.$$

Since  $\delta > 3$ , it follows from the previous equality that:

$$\delta^{q^\sharp(x_0)+1} - 2 - \delta^{\frac{2q^\sharp(x_0)+1}{2}} \geq 0. \quad (\text{A.98})$$

Thus from Eqns. A.96, A.97 and A.98 we can conclude that Eqn. A.95 holds.

From Eqns. A.94 and A.95 we can conclude that Eqn. A.93 holds.

Moreover the function  $\beta^v$  is monotonic. Thus for any  $x \in \bigcup\{K_r(q) \mid q \in \gamma^\mathcal{Q}(\{q^\sharp\})\}$  the following constraint holds:

$$\beta^v(\min(\bigcup\{K_r(q) \mid q \in \gamma^\mathcal{Q}(\{q^\sharp\})\})) \leq \beta^v(x), \quad (\text{A.99})$$

and:

$$\beta^v(x) \leq \beta^v(\max(\bigcup\{K_r(q) \mid q \in \gamma^\mathcal{Q}(\{q^\sharp\})\})). \quad (\text{A.100})$$

From Eqns A.88 and A.92, the following equality holds:

$$\beta^v(\min(\bigcup\{K_r(q) \mid q \in \gamma^\mathcal{Q}(\{q^\sharp\})\})) = \min(2q^\sharp(x_0) - 1, p). \quad (\text{A.101})$$

From Eqns A.89 and A.93, the following equality holds:

$$\beta^v(\max(\bigcup\{K_r(q) \mid q \in \gamma^\mathcal{Q}(\{q^\sharp\})\})) = \min(2q^\sharp(x_0) + 1, p). \quad (\text{A.102})$$

Therefore we can conclude from Eqns. A.99, A.100, A.101 and A.102 that:

$$\begin{cases} K_{lb}^\sharp(r, q^\sharp) &= \min(2q^\sharp(x_0) - 1, p); \\ K_{ub}^\sharp(r, q^\sharp) &= \min(2q^\sharp(x_0) + 1, p). \end{cases}$$

(c) We assume that  $q^\sharp(x_0) = p$ . It follows that:

$$\gamma^\mathcal{Q}(\{q^\sharp\})(x_0) = \llbracket \delta^p, +\infty \rrbracket.$$

Thus from Eqn. A.80, it follows that the set  $\bigcup\{K_r(q) \mid q \in \gamma^{\mathcal{Q}}(\{q^\sharp\})\}$  satisfies the following constraint:

$$\min(\bigcup\{K_r(q) \mid q \in \gamma^{\mathcal{Q}}(\{q^\sharp\})\}) = \delta^p(\delta^p - 1). \quad (\text{A.103})$$

Since  $p \geq 1$  and  $\delta \geq 2$ , it follows that:

$$\min(\bigcup\{K_r(q) \mid q \in \gamma^{\mathcal{Q}}(\{q^\sharp\})\}) \geq \delta^p. \quad (\text{A.104})$$

Since the function  $\beta^v$  is monotonic, it follows for any  $x \in \bigcup\{K_r(q) \mid q \in \gamma^{\mathcal{Q}}(\{q^\sharp\})\}$  that:

$$\beta^v(x) = p. \quad (\text{A.105})$$

Therefore we can conclude that:

$$\begin{cases} K_{lb}^\sharp(r, q^\sharp) &= p; \\ K_{ub}^\sharp(r, q^\sharp) &= p. \end{cases}$$

- (3) Finally let us consider a bimolecular reaction  $r$  of reactants  $x_1$  and  $x_2$ . By assumption we have:

$$K_r(q) = q(x_1)q(x_2).$$

We then distinguish between the following cases:

- (a) We assume that either  $q^\sharp(x_1) = 0$  or  $q^\sharp(x_2) = 0$ . It follows that the following constraints are satisfied:

$$\min(\bigcup\{K_r(q) \mid q \in \gamma^{\mathcal{Q}}(\{q^\sharp\})\}) = 0, \quad (\text{A.106})$$

and:

$$\max(\bigcup\{K_r(q) \mid q \in \gamma^{\mathcal{Q}}(\{q^\sharp\})\}) = (\delta^{q^\sharp(x_1)+1} - 1)(\delta^{q^\sharp(x_2)+1} - 1). \quad (\text{A.107})$$

Then the following inequality straightforwardly holds:

$$(\delta^{q^\sharp(x_1)+1} - 1)(\delta^{q^\sharp(x_2)+1} - 1) < (\delta^{q^\sharp(x_1)+1})(\delta^{q^\sharp(x_2)+1}). \quad (\text{A.108})$$

Let us now show that the following inequality is satisfied:

$$J(\delta, q^\sharp(x_1), q^\sharp(x_2)) \geq 0, \quad (\text{A.109})$$

where  $J(\delta, q^\sharp(x_1), q^\sharp(x_2))$  is defined as follows:

$$J(\delta, q^\sharp(x_1), q^\sharp(x_2)) = (\delta^{q^\sharp(x_1)+1} - 1)(\delta^{q^\sharp(x_2)+1} - 1) - \delta^{q^\sharp(x_1)+q^\sharp(x_2)+1}. \quad (\text{A.110})$$

$J(\delta, q^\sharp(x_1), q^\sharp(x_2))$  is invariant when exchanging  $q^\sharp(x_1)$  and  $q^\sharp(x_2)$ . We can thus assume without loss of generality that  $q^\sharp(x_2) = 0$ . Eqn. A.110 thus becomes:

$$J(\delta, q^\sharp(x_1), 0) = (\delta^{q^\sharp(x_1)+1} - 1)(\delta - 1) - \delta^{q^\sharp(x_1)+1}.$$

Developing the previous equality, we get:

$$J(\delta, q^\sharp(x_1), 0) = \delta^{q^\sharp(x_1)+2} - 2\delta^{q^\sharp(x_1)+1} - \delta + 1.$$

It follows that:

$$J(\delta, q^\sharp(x_1), 0) > \delta \left( \delta^{q^\sharp(x_1)}(\delta - 2) - 1 \right).$$

Since by assumption  $\delta > 3$ , we can conclude from the previous inequality that Eqn. A.109 holds.

From Eqns. A.108 and A.109, the following constraint is satisfied:

$$(\delta^{q^\sharp(x_1)+1} - 1)(\delta^{q^\sharp(x_2)+1} - 1) \in \llbracket \delta^{q^\sharp(x_1)+q^\sharp(x_2)+1}, \delta^{q^\sharp(x_1)+q^\sharp(x_2)+2} \rrbracket. \quad (\text{A.111})$$

Since the function  $\beta^v$  is monotonic, we can conclude from Eqns. A.106, A.107 and A.111 that:

$$\begin{cases} K_{lb}^\sharp(r, q^\sharp) & = & 0; \\ K_{ub}^\sharp(r, q^\sharp) & = & \min(q^\sharp(x_1) + q^\sharp(x_2) + 1, p). \end{cases}$$

(b) We assume that  $0 < q^\sharp(x_1) < p$  and  $0 < q^\sharp(x_2) < p$ . It follows that:

$$\min(\bigcup \{K_r(q) \mid q \in \gamma^\mathcal{Q}(\{q^\sharp\})\}) = \delta^{q^\sharp(x_1)+q^\sharp(x_2)}, \quad (\text{A.112})$$

and:

$$\max(\bigcup \{k_r(q) \mid q \in \gamma^\mathcal{Q}(\{q^\sharp\})\}) = (\delta^{q^\sharp(x_1)+1} - 1)(\delta^{q^\sharp(x_2)+1} - 1). \quad (\text{A.113})$$

Since  $\beta^v$  is monotonic we can conclude from Eqns. A.111, A.112 and A.113 that:

$$\begin{cases} K_{lb}^\sharp(r, q^\sharp) & = & \min(q^\sharp(x_1) + q^\sharp(x_2), p); \\ K_{ub}^\sharp(r, q^\sharp) & = & \min(q^\sharp(x_1) + q^\sharp(x_2) + 1, p). \end{cases}$$

(c) We assume that either  $q^\sharp(x_1) = p$  or  $q^\sharp(x_2) = p$ , and that  $q^\sharp(x_1)q^\sharp(x_2) \neq 0$ . It follows that:

$$\min(\bigcup \{K_r(q) \mid q \in \gamma^\mathcal{Q}(\{q^\sharp\})\}) = \delta^{q^\sharp(x_1)+q^\sharp(x_2)}, \quad (\text{A.114})$$

with  $q^\sharp(x_1) + q^\sharp(x_2) \geq p$ .

Since  $\beta^v$  is monotonic, we can conclude that:

$$\begin{cases} K_{lb}^\sharp(r, q^\sharp) & = & p; \\ K_{ub}^\sharp(r, q^\sharp) & = & p. \end{cases}$$

which ends the proof. □



Appendix A.7. Proof of Theorem 5

Before proving Theorem 5, we give both following lemmas.

**Lemma 1.** Let  $Y \subseteq \mathcal{T}_{esc^\#}^{\text{CROSS}\#}$  be a set of abstract traces. We have:

$$\gamma_{\dagger}^{\mathcal{T}}(Y) \subseteq \gamma^{\mathcal{T}}(\alpha_{fst}^{\dagger}(Y)).$$

**Lemma 2.** Let  $X \subseteq \mathcal{Q}_R \times T_R^*$  be a set of concrete traces. We have:

$$\alpha_{\dagger}^{\mathcal{T}}(X) \subseteq \gamma_{fst}^{\dagger}(\alpha^{\mathcal{T}}(X)).$$

We remind the reader of the statement of Theorem 5, before giving a proof of it.

**Theorem 5 (soundness).** We assume that:

- (1)  $\delta > 2V_{\infty}$ ,  $\delta > M_{\infty}$ ,  $\delta > (M + V)_{\infty}$ ;
- (2) for any class  $\mathcal{Q}'_{R,0} \in Cov$  and any state  $q \in \mathcal{Q}'_{R,0}$ , we have  $q \in f(\mathcal{Q}'_{R,0})$ ;
- (3) for any class  $\mathcal{Q}'_{R,0} \in Cov$ , for any (concrete) transition  $(q, r, q') \in T_R$ , if  $q \in f(\mathcal{Q}'_{R,0})$ , then  $q' \in f(\mathcal{Q}'_{R,0})$ ;
- (4)  $esc \subseteq esc^\#$ ;
- (5) for any concrete trace  $\tau \in \mathcal{T}_{\mathcal{R}, \mathcal{Q}'_{R,0}, \mathcal{S}}^{\text{TIME}}$  and any transition  $(q, r, q') \in T_R$  that satisfy:
  - (a)  $final(\tau) = q$ ,
  - (b)  $\beta^{\mathcal{Q}}(q) \neq \beta^{\mathcal{Q}}(q')$ , and
  - (c)  $r \in \mathcal{S}(\tau)$ ,

we have:

$$r \in \mathcal{S}^\#(\beta^{\mathcal{T}}(\tau)).$$

Under these assumptions, we have:

$$\mathcal{T}_{\mathcal{R}, \mathcal{Q}'_{R,0}, \mathcal{S}}^{\text{TIME}} \subseteq \gamma_{\dagger}^{\mathcal{T}}(\text{lfp } \mathbb{F}_{\mathcal{Q}'_{R,0}, param}^{\text{PROD}\#})$$

for any covering class  $\mathcal{Q}'_{R,0} \in Cov$ .

PROOF. We take the same notations and make the same assumptions as in the statement of Theorem 5.

Following the abstract interpretation framework, we are left to prove that the following inclusion:

$$\alpha_{\dagger}^{\mathcal{Q}}(\mathbb{F}_{\mathcal{Q}'_{R,0}}^{\mathcal{Q}}(\gamma_{\dagger}^{\mathcal{Q}}(Y))) \subseteq \mathbb{F}_{\mathcal{Q}'_{R,0}, param}^{\text{PROD}\#}(Y),$$

is satisfied, for covering class  $\mathcal{Q}'_{R,0} \in Cov$  and any set  $Y \subseteq \mathcal{T}_{esc^\#}^{\text{CROSS}\#}$  of abstract traces.

Let  $\mathcal{Q}'_{R,0}$  be a covering class in  $Cov$  and  $Y \subseteq \mathcal{T}_{esc^\#}^{\text{CROSS}\#}$  be a subset of abstract traces.

(1) By Lem. 2, the following inclusion:

$$\alpha_{\dagger}^{\mathcal{T}}(\mathbb{F}_{\mathcal{Q}'_{R,0}}(\gamma^{\mathcal{T}}(\alpha_{fst}(Y)))) \subseteq [\gamma_{fst} \circ \alpha^{\mathcal{T}}](\mathbb{F}_{\mathcal{Q}'_{R,0}}(\gamma^{\mathcal{T}}(\alpha_{fst}(Y))))$$

is satisfied.

By Lem. 1, and since the functions  $\alpha_{\dagger}^{\mathcal{T}}$  and  $\mathbb{F}_{\mathcal{Q}'_{R,0}}$  are monotonic, the following inclusion:

$$[\gamma_{fst} \circ \alpha^{\mathcal{T}}](\mathbb{F}_{\mathcal{Q}'_{R,0}}(\gamma^{\mathcal{T}}(\alpha_{fst}(Y)))) \subseteq [\gamma_{fst} \circ \alpha^{\mathcal{T}}](\mathbb{F}_{\mathcal{Q}'_{R,0}}(\gamma_{\dagger}^{\mathcal{T}}(Y)))$$

holds.

By assumptions 1, 2, and 3, the requirements of Section 5.1 are satisfied.

It follows that the following inclusion:

$$[\alpha^{\mathcal{T}} \circ \mathbb{F}_{\mathcal{Q}'_{R,0}} \circ \gamma^{\mathcal{T}}](\alpha_{fst}(Y)) \subseteq \mathbb{F}_{\mathcal{Q}'_{R,0}, f(\mathcal{Q}'_{R,0})}^{\text{INV}\#}(\alpha_{fst}(Y))$$

is satisfied.

It follows, since the function  $\gamma_{fst}$  is monotonic, that the following inclusion

$$[\gamma_{fst} \circ \alpha^{\mathcal{T}}](\mathbb{F}_{\mathcal{Q}'_{R,0}}(\gamma^{\mathcal{T}}(\alpha_{fst}(Y)))) \subseteq \gamma_{fst}(\mathbb{F}_{\mathcal{Q}'_{R,0}, f(\mathcal{Q}'_{R,0})}^{\text{INV}\#}(\alpha_{fst}(Y))).$$

holds.

Thus, the following equation:

$$\alpha_{\dagger}^{\mathcal{T}}(\mathbb{F}_{\mathcal{Q}'_{R,0}}(\gamma_{\dagger}^{\mathcal{T}}(Y))) \subseteq \gamma_{fst}(\mathbb{F}_{\mathcal{Q}'_{R,0}, f(\mathcal{Q}'_{R,0})}^{\text{INV}\#}(\alpha_{fst}(Y)))$$

holds.

(2) By assumptions 1 and 4, the requirements of Section 5.2 are satisfied.

It follows that the following inclusion:

$$\alpha_{\dagger}^{\mathcal{T}}(\mathbb{F}_{\mathcal{Q}'_{R,0}}(\gamma_{\dagger}^{\mathcal{T}}(Y))) \subseteq \mathbb{F}_{\mathcal{Q}'_{R,0}, \text{esc}\#}^{\text{CROSS}\#}(Y)$$

is satisfied.

(3) We have already proven the following inclusion:

$$\alpha^{\mathcal{T}}(\mathbb{F}_{\mathcal{Q}'_{R,0}}(\gamma^{\mathcal{T}}(\alpha_{fst}(Y))))[\gamma_{fst} \circ \alpha^{\mathcal{T}}](\mathbb{F}_{\mathcal{Q}'_{R,0}}(\gamma_{\dagger}^{\mathcal{T}}(Y)))$$

holds.

By assumptions 1, 5, the requirements of Section 5.3 are satisfied.

It follows that the following inclusion:

$$[\alpha^{\mathcal{T}} \circ \mathbb{F}_{\mathcal{Q}'_{R,0}} \circ \gamma^{\mathcal{T}}](\alpha_{fst}(Y)) \subseteq \mathbb{F}_{\mathcal{Q}'_{R,0}, \mathcal{S}\#}^{\text{TIME}\#}(\alpha_{fst}(Y))$$

is satisfied.

It follows, since the function  $\gamma_{fst}$  is monotonic, that the following inclusion

$$[\gamma_{fst} \circ \alpha^{\mathcal{T}}](\mathbb{F}_{\mathcal{Q}'_{R,0}}(\gamma^{\mathcal{T}}(\alpha_{fst}(Y)))) \subseteq \gamma_{fst}(\mathbb{F}_{\mathcal{Q}'_{R,0}, \mathcal{S}\#}^{\text{TIME}\#}(\alpha_{fst}(Y)))$$

holds.

Thus, the following equation:

$$\alpha_{\dagger}^{\mathcal{T}}(\mathbb{F}_{\mathcal{Q}'_{R,0}}(\gamma_{\dagger}^{\mathcal{T}}(Y))) \subseteq \gamma_{fst}(\mathbb{F}_{\mathcal{Q}'_{R,0},\mathcal{S}^{\sharp}}^{\text{TIME}^{\sharp}}(\alpha_{fst}(Y)))$$

holds.

By definition of  $\mathbb{F}_{\mathcal{Q}'_{R,0},param}^{\text{PROD}^{\sharp}}$ , we can conclude that the following inclusion:

$$\alpha_{\dagger}^{\mathcal{T}}(\mathbb{F}_{\mathcal{Q}'_{R,0}}(\gamma_{\dagger}^{\mathcal{Q}}(Y))) \subseteq \mathbb{F}_{\mathcal{Q}'_{R,0},param}^{\text{PROD}^{\sharp}}(Y)$$

is satisfied.

Since, the functions  $\mathbb{F}_{\mathcal{Q}'_{R,0}}$  and  $\mathbb{F}_{\mathcal{Q}'_{R,0},param}^{\text{PROD}^{\sharp}}$  are both monotonic, we can conclude, by [15], that the following inclusion:

$$\mathcal{T}_{\mathcal{R},\mathcal{Q}'_{R,0},\mathcal{S}}^{\text{TIME}} \subseteq \gamma_{\dagger}^{\mathcal{T}}(\text{lfp } \mathbb{F}_{\mathcal{Q}'_{R,0},param}^{\text{PROD}^{\sharp}})$$

is satisfied. □

#### Appendix A.8. Proof of Property 7

We remind the reader of Property 7, before giving a proof of it.

We consider the primitive  $esc^{\sharp}$  that is defined as the set of triples  $(q^{\sharp}, x_{\dagger}, r)$  which satisfy the following conditions:

- (1) either  $\delta^{q^{\sharp}(x)} < \alpha(q^{\sharp}, x)$ , where  $\alpha$  is the function mapping each couple  $(q^{\sharp'}, x')$  to the non negative integer  $\alpha(q^{\sharp'}, x')$  defined as follows:

$$\alpha(q^{\sharp'}, x') = \max(\delta^{\min(q^{\sharp'}(z) \mid M_{r'}(z) > 0) + 1} \mid r' \in \llbracket 1, n \rrbracket, V_{r'}(x') > 0);$$

- (2) or there exist a chemical species  $y$  and two reactions  $r'$  and  $r''$  in  $\llbracket 1, n \rrbracket$  which satisfy the following conditions:

- (a)  $V_{r'}(x) > 0$ ,
- (b)  $M_{r'}(y) < 0$ ,
- (c)  $q^{\sharp}(y) = \min(q^{\sharp}(z) \mid M_{r'}(z) > 0)$ ,
- (d)  $V_{r''}(y) > 0$ .

**Property 7.** *We assume that  $\delta > (n + 1)V_{\infty}$ . Then  $esc^{\sharp}$  is a superset of  $esc$ .*

PROOF. We will prove this property by proving its contraposition.

Let  $(q^{\sharp}, C)$  be a couple in  $(\mathcal{Q}_R^{\sharp} \times \wp(\mathcal{C}_{\dagger}))$  and  $x_{\dagger}$  an annotated chemical species in  $C$ .

Let  $\tau$  be a concrete trace which satisfies the following conditions:

- (1)  $\beta^{\mathcal{Q}}(\text{first}(\tau)) = q^{\sharp}$ ,
- (2)  $\text{first}(\tau) \models x_{\dagger}$ .

Let us show that the following inequality holds:

$$final(\tau)(x) < \delta^{q^\sharp(x)+1}. \quad (\text{A.115})$$

First it follows from the definition of  $\tau$  that:

- (1) either  $first(\tau)(x)$  is in the interval  $\llbracket \delta^{q^\sharp(x)}, \delta^{q^\sharp(x)} + V_\infty \rrbracket$ ,
- (2) or there is no concrete trace  $\tau$  in  $\mathcal{T}_{R, \{first(\tau)\}}$  such that:

$$\beta^{\mathbb{R}}(final(\tau)(x)) > \beta^{\mathbb{R}}(first(\tau)(x)).$$

If the previous condition (2) is satisfied then Eqn. A.115 straightforwardly holds.

Let us assume that condition (1) holds, that is to say:

$$first(\tau)(x) \in \llbracket \delta^{q^\sharp(x)}, \delta^{q^\sharp(x)} + V_\infty \rrbracket. \quad (\text{A.116})$$

Let  $w \in \mathbb{N}^{\llbracket 1, n \rrbracket}$  be the vector defined as follows:

$$w = (w_1, w_2, \dots, w_n),$$

where, for all  $i$  between 1 and  $n$ ,  $w_i$  is the number of occurrences of the reaction  $i$  in the trace  $\tau$ .

Then summing the equations which update the number of instances of the chemical species for each transition composing the trace  $\tau$ , we get for all  $x' \in \nu$ :

$$0 \leq first(\tau)(x') + V_w(x') = final(\tau)(x'), \quad (\text{A.117})$$

where:

$$V_w(x') = \sum_{1 \leq r' \leq n} w(r') V_{r'}(x').$$

From Eqn.A.116, it follows that:

$$0 \leq final(\tau)(x) \leq \delta^{q^\sharp(x)} + V_\infty + V_w(x). \quad (\text{A.118})$$

By definition of  $V_w(x)$  the following inequality holds:

$$V_w(x) \leq \sum_{1 \leq r' \leq n} (w(r') V_{r'}(x) \mid V_{r'}(x) > 0).$$

By definition of  $V_\infty$ , it follows that:

$$V_w(x) \leq V_\infty \sum_{1 \leq r' \leq n} (w(r') \mid V_{r'}(x) > 0). \quad (\text{A.119})$$

Then let  $Y$  be the set of chemical species such that for any  $y \in Y$  there exists a reaction  $r' \in \llbracket 1, n \rrbracket$  which satisfies the following conditions:

- (1)  $V_{r'}(x) > 0$ ,
- (2)  $M_{r'}(y) < 0$ , and
- (3)  $q^\sharp(y) = \min(q^\sharp(z) \mid M_{r'}(z) > 0)$ .

By assumption, for any  $y \in Y$  and any reaction  $r' \in \llbracket 1, n \rrbracket$ , we have:

$$V_{r'}(y) \leq 0. \quad (\text{A.120})$$

From Eqn.A.117 the following inequality holds for any  $y \in Y$ :

$$0 \leq V_w(y) + \text{first}(\tau)(y).$$

From Eqn. A.120 and by definition of  $V_w(y)$  it follows that for any  $y \in Y$ :

$$0 \leq \sum_{1 \leq r' \leq n} (w(r')V_{r'}(y) \mid V_{r'}(y) < 0) + \text{first}(\tau)(y).$$

Moreover we have for any  $y \in Y$ :

$$\text{first}(\tau)(y) < \delta^{q^\sharp(y)+1}.$$

Thus we have for any  $y \in Y$ :

$$0 < \sum_{1 \leq r' \leq n} (w(r')V_{r'}(y) \mid V_{r'}(y) < 0) + \delta^{q^\sharp(y)+1}.$$

Rearranging the previous inequality, we get for any  $y \in Y$ :

$$\sum_{1 \leq r' \leq n} (w(r')|V_{r'}(y)| \mid V_{r'}(y) < 0) < \delta^{q^\sharp(y)+1}.$$

Since  $w(r') \geq 0$  for any  $r' \in \llbracket 1, n \rrbracket$ , it follows straightforwardly that for any  $y \in Y$  and any  $r'$  such that  $V_{r'}(y) < 0$  we have:

$$w(r')|V_{r'}(y)| < \delta^{q^\sharp(y)+1}.$$

Since for any  $r'$  such that  $V_{r'}(y) < 0$  we have  $|V_{r'}(y)| \geq 1$  (by definition of  $V_r$ ) it follows from the previous inequality that for any  $y \in Y$  and any  $r'$  such that  $V_{r'}(y) < 0$  we have:

$$w(r') < \delta^{q^\sharp(y)+1}. \quad (\text{A.121})$$

By definition of  $Y$  it follows straightforwardly that for any  $r' \in \llbracket 1, n \rrbracket$  such that  $V_{r'}(x) > 0$  there exists  $y \in Y$  such that:

$$V_{r'}(y) < 0,$$

and such that:

$$q^\sharp(y) = \min(q^\sharp(z) \mid M_{r'}(z) > 0).$$

Thus from Eqn. A.121 and from the previous statement it follows that for any  $r' \in \llbracket 1, n \rrbracket$  such that  $V_{r'}(x) > 0$  we have:

$$w(r') < \delta^{\min(q^\sharp(z) \mid M_{r'}(z) > 0)+1}. \quad (\text{A.122})$$

From Eqns. A.119 and A.122 it follows that:

$$V_w(x) < nV_\infty \max(\delta^{\min(q^\sharp(z) \mid M_{r'}(z) > 0)+1} \mid r' \in \llbracket 1, n \rrbracket, V_{r'}(x) > 0). \quad (\text{A.123})$$

From Eqns. A.123 and A.118 it follows that:

$$final(\tau)(x) < \delta^{q^\sharp(x)} + V_\infty + nV_\infty\alpha(q^\sharp, x),$$

where:

$$\alpha(q^\sharp, x) = \max(\delta^{\min(q^\sharp(z) \mid M_{r'}(z) > 0) + 1} \mid r' \in \llbracket 1, n \rrbracket, V_{r'}(x) > 0).$$

Since by assumption  $\alpha(q^\sharp, x) \leq \delta^{q^\sharp(x)}$  it follows from the previous inequality that:

$$final(\tau)(x) < \delta^{q^\sharp(x)} + V_\infty + nV_\infty\delta^{q^\sharp(x)}.$$

By assumption we further have:

$$(n + 1)V_\infty + 1 \leq \delta.$$

Since  $q^\sharp(x) \geq 0$  it follows that:

$$V_\infty + (nV_\infty + 1)\delta^{q^\sharp(x)} \leq \delta^{q^\sharp(x) + 1}.$$

We then conclude that Eqn. A.115 holds, which ends the proof.

## Appendix B. Asynchronous update policy

Update policies play an important role in qualitative models. In a synchronous transition, the number of instances of several chemical species move simultaneously from one interval to another one. Conversely, in an asynchronous transition, the number of instances of at most one chemical species can move simultaneously from an interval to another one. Since our model is coarse-grained, synchronous transitions are somehow quite unlikely. Yet they cannot be discarded without breaking the soundness of our modelling approach.

In some models, synchronous updates can be simulated by a sequence of asynchronous updates. In such situations, it is more convenient to consider only asynchronous updates, so as to reduce the out-degree of the states in the abstract transition system (indeed, in a given state, the number of potential distinct synchronous updates is exponential with respect to the number of distinct asynchronous ones), while preserving the soundness of the approach.

Yet it is not always possible. Let us consider a simple counter-example. We assume that we have two kinds of proteins  $A$  and  $B$ , which can be degraded simultaneously. This situation can be modelled by the following reaction:



Providing that the number of instances of the protein  $A$  and the number of instances of the protein  $B$  are equal in the initial state, they will remain equal forever, which can be described by the state invariant  $q(A) = q(B)$ . Then we consider the synchronous transition that consists in going from the state  $q^\sharp(A) = 1$  and  $q^\sharp(B) = 1$ , to the state  $q^\sharp(A) = 0$  and  $q^\sharp(B) = 0$ . This transition cannot be simulated by a sequence of asynchronous transitions without passing either by the state  $q^\sharp(A) = 1$  and  $q^\sharp(B) = 0$  or by the state  $q^\sharp(A) = 0$  and  $q^\sharp(B) = 1$ , which in both cases would violate the state invariant  $q^\sharp(A) = q^\sharp(B)$ .

In our framework, this counter-example raises no issue. Indeed, we abstract precisely semi-positive relationships only, thus this state invariant  $q(A) = q(B)$  will be discarded by our abstraction. Consequently, fictitious intermediary states are introduced due to the inaccuracy of our abstraction, which makes it possible to simulate synchronous updates with sequences of asynchronous ones.

In the following, we assume that  $\delta$  is strictly greater than the maximum of  $M_\infty$  and  $(M + V)_\infty$ , and strictly greater than the sum of the coefficients of all the semi-positive constraints that occur in  $inv_p^\sharp$ . Thus, the assumptions of Property 1 and Property 2 are satisfied.

Under these assumptions, we show that it is always possible in our abstract semantics to simulate synchronous transitions with sequences of asynchronous ones in the absence of several separated time scales. Then, we propose a scheduler that simulates synchronous updates with a sequence of asynchronous ones even in the presence of several separated time scales.

#### Appendix B.1. In the absence of different time scales

Firstly, we assume that the function  $\mathcal{S}^\sharp$  maps any abstract (pre)trace to the set  $\llbracket 1, n \rrbracket$ , that is to say that no reaction is preempted by any other one. We show that the trace semantics is preserved when restricting the transitions to asynchronous ones.

Let us give a formal definition for asynchronous transitions.

**Definition 8 (asynchronous transitions).** A transition  $((q, C), r, (q', C')) \in T_{param}^{PROD^\sharp}$  is asynchronous if and only if there exists a chemical species  $x \in \nu$  such that for any other chemical species  $y \in \nu \setminus \{x\}$  we have  $q(y) = q'(y)$ .

There are indeed two kinds of asynchronous transitions. The first category corresponds to the regular computation steps in which the number of instances of exactly one chemical species changes of interval. The second category corresponds to the computation steps in which the number of instances of the chemical species remain the same, but one constraint of the form  $x_\dagger$  is removed.

**Theorem 7 (asynchronous update).** Let  $((q^\sharp, C), r, (q^\sharp', C')) \in T_{param}^{PROD^\sharp}$ , then there exists a trace  $\tau$  such that: (1)  $first(\tau) = (q^\sharp, C)$ , (2)  $final(\tau) = (q^\sharp', C')$ , (3) each transition that occurs in  $\tau$  is asynchronous.

PROOF. We do this proof by case analysis on the synchronous transition  $((q^\sharp, C), r, (q^\sharp', C'))$ .

- (1) Whenever  $q^\sharp = q^\sharp'$ .

The transition consists in removing a constraint of the form  $x_\dagger$ , thus it is already asynchronous.

- (2) Whenever for all  $x \in \nu$ ,  $q^\sharp(x) \leq q^\sharp'(x)$ .

We can go gradually from  $(q^\sharp, C)$  to  $(q^\sharp', C')$  by using asynchronous transitions labelled with  $r$  to increment, at each step, the number of instances of only one chemical species  $x$  while adding the constraint  $x_\dagger$ .

We have to show that each of these transitions belongs to the set  $T_{param}^{PROD^\sharp}$ .

We consider  $q^{\sharp''}$  an intermediary state. By construction, we have for all  $x \in \nu$ ,  $q^\sharp(x) \leq q^{\sharp''}(x) \leq q^\sharp'(x)$ .

Thus:

- (a) the state  $q^{\sharp\prime\prime}$  is reachable in the initial abstract semantics (e.g. see Prop. 1.(4));
- (b) the state  $q^{\sharp\prime\prime}$  satisfies each semi-positive constraint that is satisfied both by the state  $q^{\sharp}$  and the state  $q^{\sharp\prime}$  (by Prop. 2 and because for any set  $\mathcal{X} \subseteq \nu$ , we have  $\max\{q^{\sharp}(x) \mid x \in \mathcal{X}\} \leq \max\{q^{\sharp\prime\prime}(x) \mid x \in \mathcal{X}\}$  and  $\max\{q^{\sharp\prime\prime}(x) \mid x \in \mathcal{X}\} \leq \max\{q^{\sharp\prime}(x) \mid x \in \mathcal{X}\}$ );
- (c) each intermediary transition belongs to the set  $T_{esc^{\sharp}}^{CROSS^{\sharp}}$  because it increases the number of instances of a chemical species which can actually be incremented (since the transition  $((q^{\sharp}, C), r, (q^{\sharp\prime}, C'))$  belongs to  $T_{esc^{\sharp}}^{CROSS^{\sharp}}$ ).

We can conclude that each intermediary transition belongs to the set  $T_{param}^{PROD^{\sharp}}$ .

- (3) Whenever for all  $x \in \nu$ ,  $q^{\sharp}(x) \geq q^{\sharp\prime}(x)$ .

This case is similar to the previous one, except that, we can go gradually from  $(q^{\sharp}, C)$  to  $(q^{\sharp\prime}, C')$  by using asynchronous transitions labelled with  $r$  to decrement, at each step, the number of instances of only one chemical species  $x$  (instead of incrementing it) while removing the constraint  $x_{\dagger}$  (instead of adding it).

- (4) Otherwise. The transition can be decomposed into two synchronous ones. The first one  $((q^{\sharp}, C), r, ([x \mapsto \max\{q^{\sharp}(x), q^{\sharp\prime}(x)\}], C \cup C'))$  increases all the values which have to be increased. The second one  $(([x \mapsto \max\{q^{\sharp}(x), q^{\sharp\prime}(x)\}], C \cup C'), r, (q^{\sharp\prime}, C'))$  decreases all the values which have to be decreased. Both transitions belong to the set  $T_{param}^{PROD^{\sharp}}$  because:

- (a) the state  $[x \mapsto \max\{q^{\sharp}(x), q^{\sharp\prime}(x)\}]$  is reachable in the initial abstract semantics (see Prop. 1.(4));
- (b) the state  $[x \mapsto \max\{q^{\sharp}(x), q^{\sharp\prime}(x)\}]$  satisfies each semi-positive constraint that is satisfied both by the state  $q^{\sharp}$  and the state  $q^{\sharp\prime}$  (by Prop. 2 and because for any set  $\mathcal{X} \subseteq \nu$ , the value

$$\max\{\max\{q^{\sharp}(x), q^{\sharp\prime}(x)\} \mid x \in \mathcal{X}\}$$

is either equal to the value  $\max\{q^{\sharp}(x) \mid x \in \mathcal{X}\}$  or to the value  $\max\{q^{\sharp\prime}(x) \mid x \in \mathcal{X}\}$ ;

- (c) the transitions of the following form:

$$((q^{\sharp}, C), r, ([x \mapsto \max\{q^{\sharp}(x), q^{\sharp\prime}(x)\}], C \cup C'))$$

belong to the set  $T_{esc^{\sharp}}^{CROSS^{\sharp}}$ , since  $((q^{\sharp}, C), r, (q^{\sharp\prime}, C \cup C')) \in T_{esc^{\sharp}}^{CROSS^{\sharp}}$  and because both transitions increase the number of instances of the same chemical species as the transition  $((q^{\sharp}, C), r, (q^{\sharp\prime}, C \cup C'))$  and add the same constraints (moreover, it increases the number of instances of at least one chemical species, otherwise we would be in the second case);



(d) the transitions of the following form:

$$((x \mapsto \max\{q^\sharp(x), q^{\sharp'}(x)\}], C \cup C'), r, (q^{\sharp'}, C'))$$

belong to the set  $T_{esc^\sharp}^{CROSS^\sharp}$ , because they increase the number of instances of no chemical species and remove the corresponding constraints (moreover, they decrease the number of instances of at least one chemical species, otherwise we would be in the previous case).

We conclude by applying the previous case (2) (resp. (3)) to the first transition (resp. the second one).

It is worth noticing that the Proof of Theorem 7 is valid only because we have taken the best abstraction of the mass preservation invariants. Another abstraction might have led to a less regular set of reachable states and might have allowed some spurious synchronous transitions, which could not have been simulated by sequences of asynchronous ones.

#### Appendix B.2. In the presence of different time scales

In the presence of several time scales (i.e. whenever the function  $\mathcal{S}^\sharp$  does not map each trace to the set  $\llbracket 1, n \rrbracket$ ), we need additional materials to simulate synchronous transitions with sequences of asynchronous ones. The issue is that the time scale of some reactions may change during the computation of a sequence of asynchronous transitions, which may block the computation of the rest of this sequence.

This is a common problem in distributed systems based on threads with priorities. This issue is usually solved by delaying the preemption of the current thread by the other ones. This means that we can let the current thread finish its computation, even if there are threads with a higher priority.

To do this, we equip the states of our abstract transitions with some information about the rule that is being computed asynchronously. Thus a state is now a pair  $((q^\sharp, C), (r, \mathcal{X}))$ , where  $r$  is the index of the rule being executed and  $\mathcal{X}$  the set of the chemical species whose number of instances has already been updated by the application of the current rule. An initial state is of the form  $((q^\sharp, C), (0, \emptyset))$  to denote the fact that no rule is currently computed.

Now we define the set of the transitions accordingly.

**Definition 9.** A transition is a triple  $((q^\sharp, C), (i, \mathcal{X}), r, ((q^{\sharp'}, C'), (r, \mathcal{X}')))$  such that  $((q^\sharp, C), r, (q^{\sharp'}, C')) \in T_{(inv_p^\sharp, esc^\sharp, \emptyset)}^{PROD^\sharp}$  and one of the following condition is satisfied:

- (1)  $\mathcal{X}' = \{x \in \nu \mid q^\sharp(x) \neq q^{\sharp'}(x)\}$  and  $(q^{\sharp'}, r) \in \mathcal{S}^\sharp$ ;
- (2)  $r = i$ ,  $\mathcal{X} \cap \{x \in \nu \mid q^\sharp(x) \neq q^{\sharp'}(x)\} = \emptyset$ , and  $\mathcal{X}' = \mathcal{X} \cup \{x \in \nu \mid q^\sharp(x) \neq q^{\sharp'}(x)\}$ .

Definition 9 distinguishes between two kinds of transitions. The first kind of transitions consists in regular steps and updates the information about the rule that has just begun its computation. The other kind of transitions keeps on computing the current rule. It can update the number of instances of the chemical species that have not been already updated, and adds them to the set of chemical species whose number of instances has already been updated.

The following theorem establishes the soundness of our new transition system.

**Theorem 8.** *The asynchronous transitions in Definition 9 faithfully simulated the transitions in  $T_{param}^{\text{PROD}\sharp}$ .*

*That is to say that the following properties are satisfied:*

- (1) *For any transition  $((q^\sharp, C), r, (q^{\sharp'}, C')) \in T_{param}^{\text{PROD}\sharp}$ , there exists a trace  $\tau$  of asynchronous transitions such that  $\text{first}(\tau) = ((q^\sharp, C), (0, \emptyset))$ ,  $\text{final}(\tau) = ((q^{\sharp'}, C'), (r, \{x \in \nu \mid q^\sharp(x) \neq q^{\sharp'}(x)\}))$ , and any transition in  $\tau$  satisfies Definition 9.*
- (2) *For any trace of elements:*

$$(((q_0^{\sharp'}, C'_0), (s'_0, \emptyset)), ((q_i^\sharp, C_i), (s_i, \mathcal{X}_i)), r_i, ((q_i^{\sharp'}, C'_i), (s'_i, \mathcal{X}'_i)))_{1 \leq i \leq k}$$

*such that:*

- (a)  $(q_0^{\sharp'}, s'_0) \notin \mathcal{S}^\sharp$ ;
- (b)  $(q_i^\sharp, s_i) \in \mathcal{S}^\sharp$  for any  $i \in \llbracket 1, k \rrbracket$ ;
- (c) *the transition  $((q_i^\sharp, C_i), (s_i, \mathcal{X}_i)), r_i, ((q_i^{\sharp'}, C'_i), (s'_i, \mathcal{X}'_i))$  satisfies Definition 9 for any  $i$  between 1 and  $k$ ;*

*we have:*

- (a)  $r_1 = r_i$  and  $r_1 = s_i$  and  $r_1 = s'_i$  for any  $i \in \llbracket 1, n \rrbracket$ ;
- (b) *the triple  $((q_1^\sharp, C_1), r_1, (q_k^{\sharp'}, C'_k))$  belongs to the set  $T_{param}^{\text{PROD}\sharp}$ .*

In Theorem 8, the first property establishes that the sequences of asynchronous transitions of Definition 9 simulate all the transitions in  $T_{param}^{\text{PROD}\sharp}$ , whereas the second one establishes that a sequence of asynchronous transitions can simulate only transitions in  $T_{param}^{\text{PROD}\sharp}$  (and thus delaying the preemption of rules with low priority does not add new behaviours to our abstract semantics). The proof of Theorem 8 follows from Theorem 7, and from the fact that we have recorded the chemical species whose number of instances has already been updated in the current reaction, so as to avoid to update them twice.

## Appendix C. Analytic solutions

We detail here the (manual) derivation of the analytic solutions of the two case studies considered in this work.

### Appendix C.1. The model with the adaptor

We recall the reactions of the first case study showing a sequestration effect:

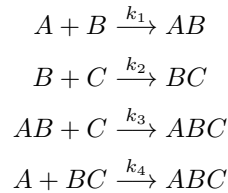

We obtain the following ordinary differential equations under the assumption of the law of mass action:

$$\left\{ \begin{array}{l} \frac{d[A]}{dt} = -[A](k_1[B] + k_4[BC]) \\ \frac{d[B]}{dt} = -[B](k_1[A] + k_2[C]) \\ \frac{d[C]}{dt} = -[C](k_2[B] + k_3[AB]) \\ \frac{d[AB]}{dt} = k_1[A][B] - k_3[AB][C] \\ \frac{d[BC]}{dt} = k_2[B][C] - k_4[A][BC] \\ \frac{d[ABC]}{dt} = k_3[AB][C] + k_4[A][BC] \end{array} \right.$$

This system admits the following (non-unique) mass invariants:

$$\left\{ \begin{array}{l} A_T = [A] + [AB] + [ABC], \\ B_T = [B] + [AB] + [BC] + [ABC], \\ C_T = [C] + [BC] + [ABC], \end{array} \right.$$

where  $A_T$ ,  $B_T$  and  $C_T$  are constants depending on the initial conditions.

Whenever  $k_1 = k_4$  and  $k_2 = k_3$ , it is possible to express analytically the evolution of the concentration of each chemical species over time. Indeed, in such a case, the binding between proteins  $A$  and  $B$  is independent from the fact that  $B$  is already bound to a  $C$  or not [29]. Thus, the system can be decomposed into two subsystems by introducing the macrospecies  $B?$ ,  $?B$ ,  $?BC$  and  $AB?$  whose concentrations are defined as follows:

$$\left\{ \begin{array}{l} [B?] = [B] + [BC], \\ [AB?] = [AB] + [ABC], \end{array} \right. \quad \left\{ \begin{array}{l} [?B] = [B] + [AB], \\ [?BC] = [BC] + [ABC]. \end{array} \right.$$

The evolution of the concentration of the macrospecies is driven by the two following reactions:

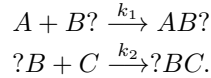

Thus, each subsystem can be solved. In particular, we have:

$$[AB?] = \begin{cases} A_T - \frac{A_{in}}{1 + A_{in}k_1t} & \text{whenever } A_{in} = B_{in} + BC_{in}, \\ A_T - \frac{(B_{in} + BC_{in} - A_{in})A_{in}}{(B_{in} + BC_{in})e^{(B_{in} + BC_{in} - A_{in})k_1t} - A_{in}} & \text{whenever } A_{in} \neq B_{in} + BC_{in}. \end{cases}$$

$$[?BC] = \begin{cases} C_T - \frac{C_{in}}{1 + C_{in}k_2t} & \text{whenever } C_{in} = B_{in} + AB_{in}, \\ C_T - \frac{(B_{in} + AB_{in} - C_{in})C_{in}}{(B_{in} + AB_{in})e^{(B_{in} + AB_{in} - C_{in})k_2t} - C_{in}} & \text{whenever } C_{in} \neq B_{in} + AB_{in}. \end{cases}$$

where  $A_{in}$ ,  $B_{in}$ ,  $C_{in}$ ,  $AB_{in}$  and  $BC_{in}$  denote the initial concentration of  $A$ ,  $B$ ,  $C$ ,  $AB$  and  $BC$  respectively.

We can conclude on the analytical expression of the concentration of  $ABC$ , from the fact that the binding of an instance of a protein  $B$  with an instance of a protein  $A$  is independent from the binding of this instance of the protein  $B$  with an instance of a protein  $C$ :

$$[ABC] = \frac{[AB?][?BC]}{B_T}.$$

In particular, when the reactions have run to completion (i.e. when  $t$  tends towards  $+\infty$ ), we have:

$$[ABC] = \frac{(\min\{A_T, B_T\})(\min\{C_T, B_T\})}{B_T}.$$

It follows that the concentration of the chemical species  $ABC$  at system completion is  $B_T$  whenever  $B_T \leq \min\{A_T, C_T\}$ , whereas it is equal to  $\frac{A_T C_T}{B_T}$  whenever  $B_T \geq \max\{A_T, C_T\}$ .

#### Appendix C.2. The model with a race between a unary and a binary reaction

We recall the reactions of the second case study showing a race between a unary and a binary reaction:

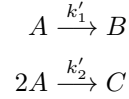

The system of ordinary equations of the model under the assumptions of the law of mass action is:

$$\begin{cases} \frac{d[A]}{dt} = -k'_1[A] - 2k'_2[A]^2, \\ \frac{d[B]}{dt} = k'_1[A], \\ \frac{d[C]}{dt} = k'_2[A]^2. \end{cases}$$

The system of ordinary equations of the model can be solved analytically. First this system admits the following (non-unique) invariant:

$$[A] + [B] + 2[C] = A_T,$$

where  $A_T$  is a constant that depends on the initial conditions.

We can then derive from these equations the analytical expression of the concentration of  $A$ ,  $B$  and  $C$ :

$$\begin{aligned} [A] &= \frac{k'_1 A_{in}}{(k'_1 + 2k'_2 A_{in}) e^{k'_1 t} - 2k'_2 A_{in}}, \\ [B] &= \frac{k'_1}{2k'_2} \ln \left( 1 + \frac{2k'_2 A_{in}}{k'_1} (1 - e^{-k'_1 t}) \right) + B_{in}, \\ [C] &= \frac{A_{in} + B_{in} - [A] - [B]}{2} + C_{in}, \end{aligned}$$

where  $A_{in}$ ,  $B_{in}$  and  $C_{in}$  denote the initial concentration of the protein  $A$ ,  $B$  and  $C$  respectively.

In particular, when the reactions have run to completion (i.e. when  $t$  tends towards  $+\infty$ ), we get the following expression of the ratio between the produced concentrations of  $C$  and  $B$ :

$$\frac{[C] - C_{in}}{[B] - B_{in}} = 0.5 \left( \frac{\frac{2k'_2 A_{in}}{k'_1}}{\ln \left( 1 + \frac{2k'_2 A_{in}}{k'_1} \right)} - 1 \right).$$

We conclude that, at system completion, the produced concentration of the chemical species  $C$  is much greater (resp. much lower) than the produced concentration of the chemical species  $B$  when  $2k'_2 A_{in} \gg k'_1$  (resp. when  $2k'_2 A_{in} \ll k'_1$ ).