



**HAL**  
open science

## Evaluation of the current distribution of the hybrid common ground stimulation in cochlear implants

Kai Dang, Pierre Stahl, Clair Vandersteen, Nicolas Guevara, Dan Gnansia, Maureen Clerc

► **To cite this version:**

Kai Dang, Pierre Stahl, Clair Vandersteen, Nicolas Guevara, Dan Gnansia, et al.. Evaluation of the current distribution of the hybrid common ground stimulation in cochlear implants. 9th International Symposium on Objective Measures in Auditory Implants (OMAI), Jun 2016, Szeged, Hungary. hal-01377653

**HAL Id: hal-01377653**

**<https://inria.hal.science/hal-01377653>**

Submitted on 7 Oct 2016

**HAL** is a multi-disciplinary open access archive for the deposit and dissemination of scientific research documents, whether they are published or not. The documents may come from teaching and research institutions in France or abroad, or from public or private research centers.

L'archive ouverte pluridisciplinaire **HAL**, est destinée au dépôt et à la diffusion de documents scientifiques de niveau recherche, publiés ou non, émanant des établissements d'enseignement et de recherche français ou étrangers, des laboratoires publics ou privés.



# Evaluation of the current distribution of the hybrid common ground stimulation in cochlear implants

Kai Dang<sup>1,2</sup>, Pierre Stahl<sup>2</sup>, Clair Vandersteen<sup>3</sup>, Nicolas Guevara<sup>3</sup>, Dan Gnansia and Maureen Clerc<sup>1</sup>

<sup>1</sup> Athena project team, Inria Sophia Antipolis, France;

<sup>2</sup> Oticon Medical CI Scientific Research, Vallauris, France;

<sup>3</sup> Head and Neck Surgery University Institute, Nice University Hospital, Nice, France.

## Introduction

The multi-mode grounding / hybrid common ground is a stimulation type of cochlear implants. It combines the current pathways of two stimulation types: the monopolar and the common ground.

In the common ground mode, the stimulation current passes from one intracochlear electrode (the stimulating electrode) to all the other electrodes on the array. The actual current distribution is heavily influenced by the position of the stimulating electrode.

Whereas in monopolar mode, the stimulation current flows from

the stimulating electrode to an extracochlear electrode (the reference electrode) placed between the skull and scalp. It consumes less energy and leads to high dynamics. But also has a higher spatial current spread due to the long distance between the stimulating and grounding positions.

In theory, the multi-mode grounding can lead to a compromise between the current focality and the efficiency of the stimulation. Even if this stimulation type has already been adopted by some implant manufacturers, its actual current pathway remains to be studied.

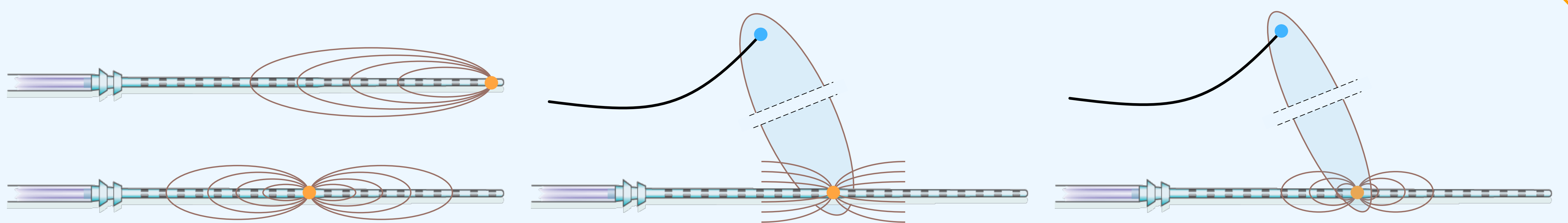

(a) common ground

(b) monopolar

(c) multi-mode grounding

Figure 1. Current pathways of 3 different stimulation modes. ● : stimulating electrode; ● : reference electrode

## Methods

The study is two-fold. First, we conducted an in-vitro experiment aimed to measure the potential field produced by the multi-mode grounding.

An electrode array of an XP implant (Oticon Medical, Neurelec) was placed in a 3-D printed container filled with saline solution (figure 2(a)). A probe driven by the printing head of a 3-D printer (figure 2(b)) moves near the array to record the voltage distribution in the saline during the stimulation. The position of measure points is shown in figure 2(c). The distances between the points are 0.05mm in each column and 0.2mm in each row.

Second, to make an in-situ measurement of the current distribution in the cochlea, another XP device with the electrode was implanted into a human specimen. The measuring system shown in figure 3 made recordings of the current strength on each electrode during the multi-mode grounding stimulation.

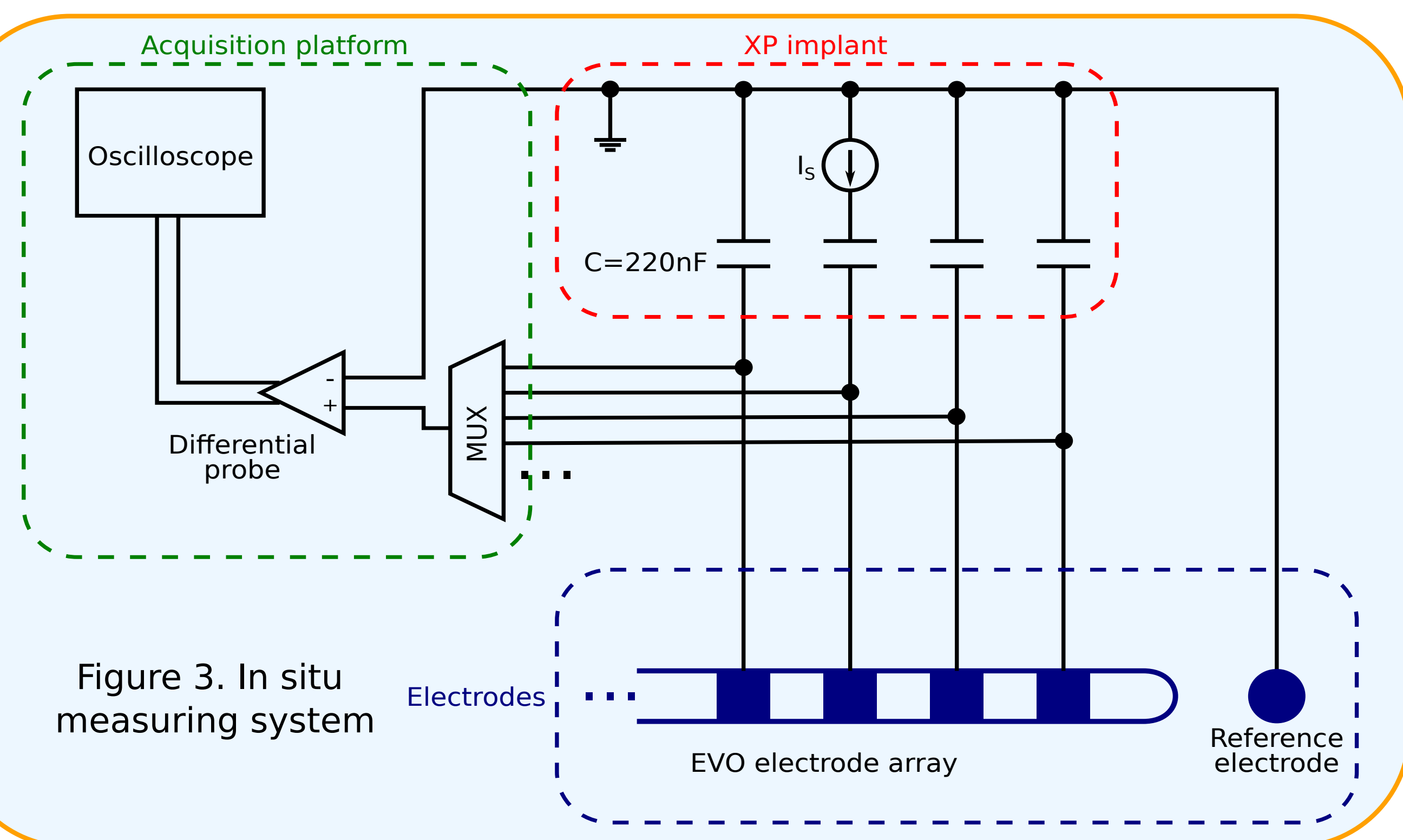
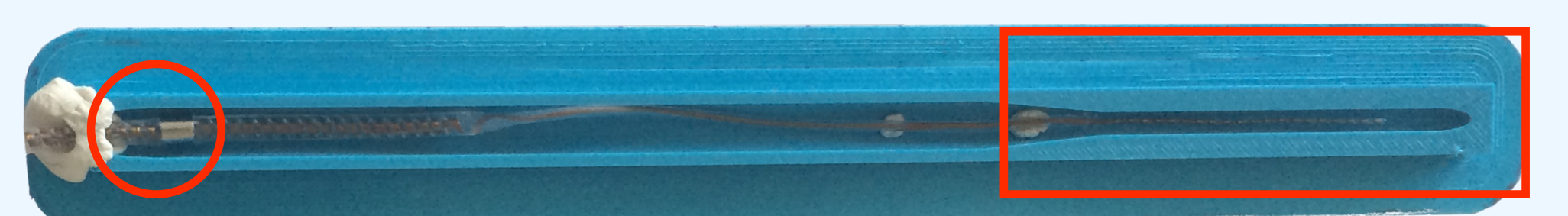

Figure 3. In situ measuring system



Reference electrode

EVO electrode array

(a) 3-D printed electrode container

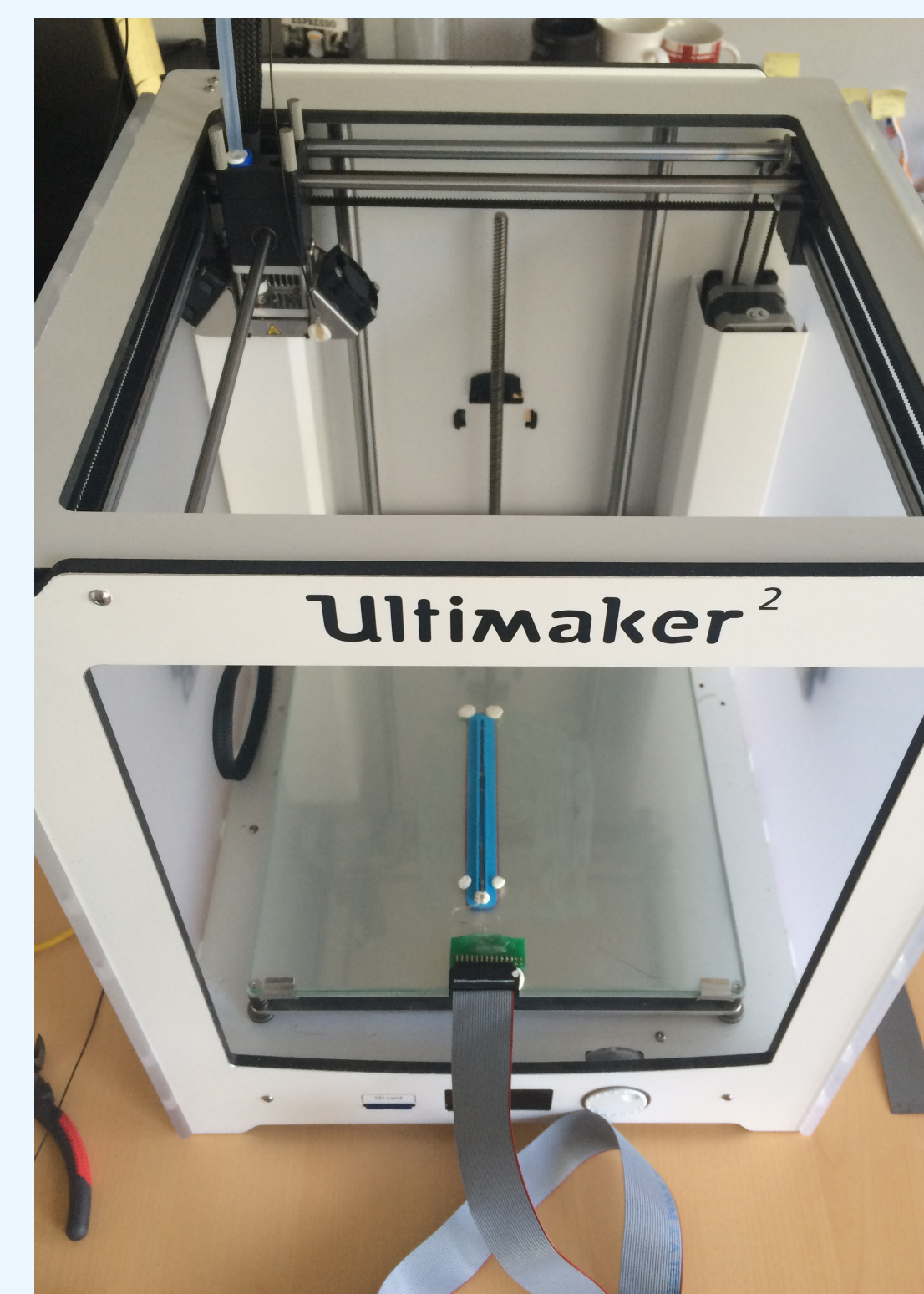

(b) 3-D printer for probe positioning

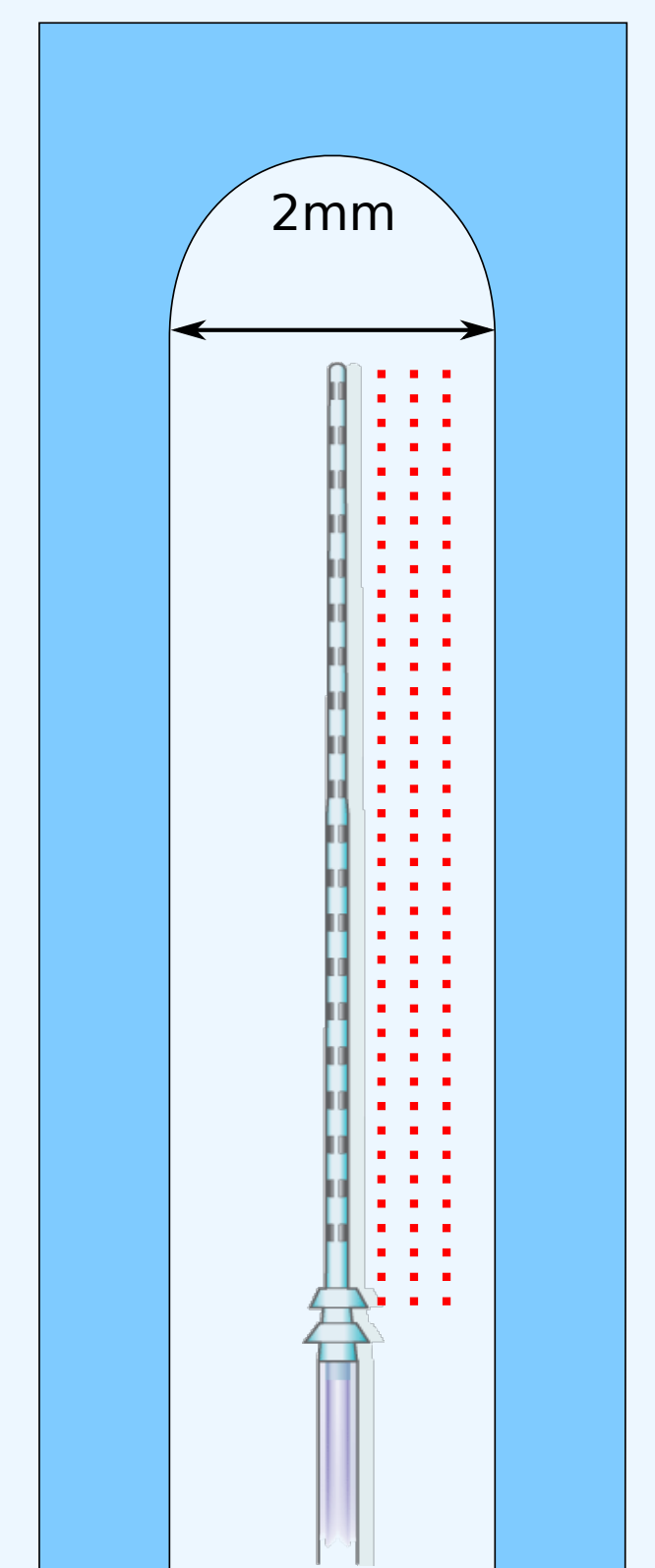

(c) Positions of the measure points

Figure 2. In vitro measuring system

## Results

The waveforms of multi-mode grounding stimulation measured in vitro are shown in figure 4.

In the stimulation phase, the stimulating electrode sends out constant current while the blocking capacitors of the non-stimulating electrode get charged by the returning current. In the passive discharge phase, all the electrodes are connected to the ground to let blocking capacitors get discharged through the cochlear tissue.

Figure 5 is plotted by measuring the peak of the two phases in figure 4

recorded at the points in figure 2(c). The anodic peak is the stimulation phase while the cathodic peak is the passive discharge phase. The latter shows a more focused current distribution. Two stimulating positions: the 1st(basal) and the 10th(middle) electrode are shown in the figure.

Figure 6 gives the distribution of returning current on the non stimulating electrodes from in situ measurements. Electrode 1-3 were not inserted into the cochlear during the experiment.

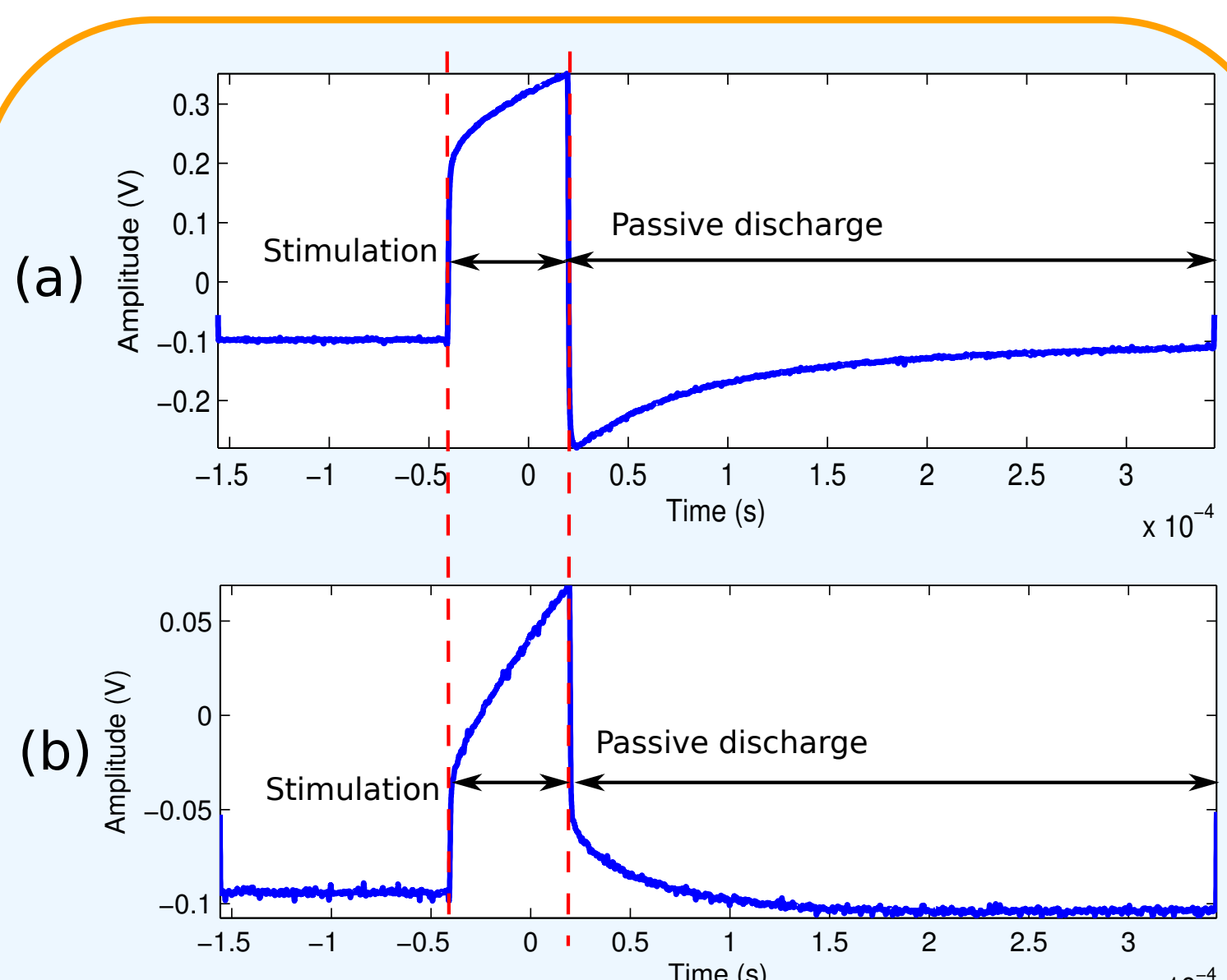

Figure 4. Stimulation waveform measured from: (a) near a stimulating electrode; (b) near a non-stimulating electrode

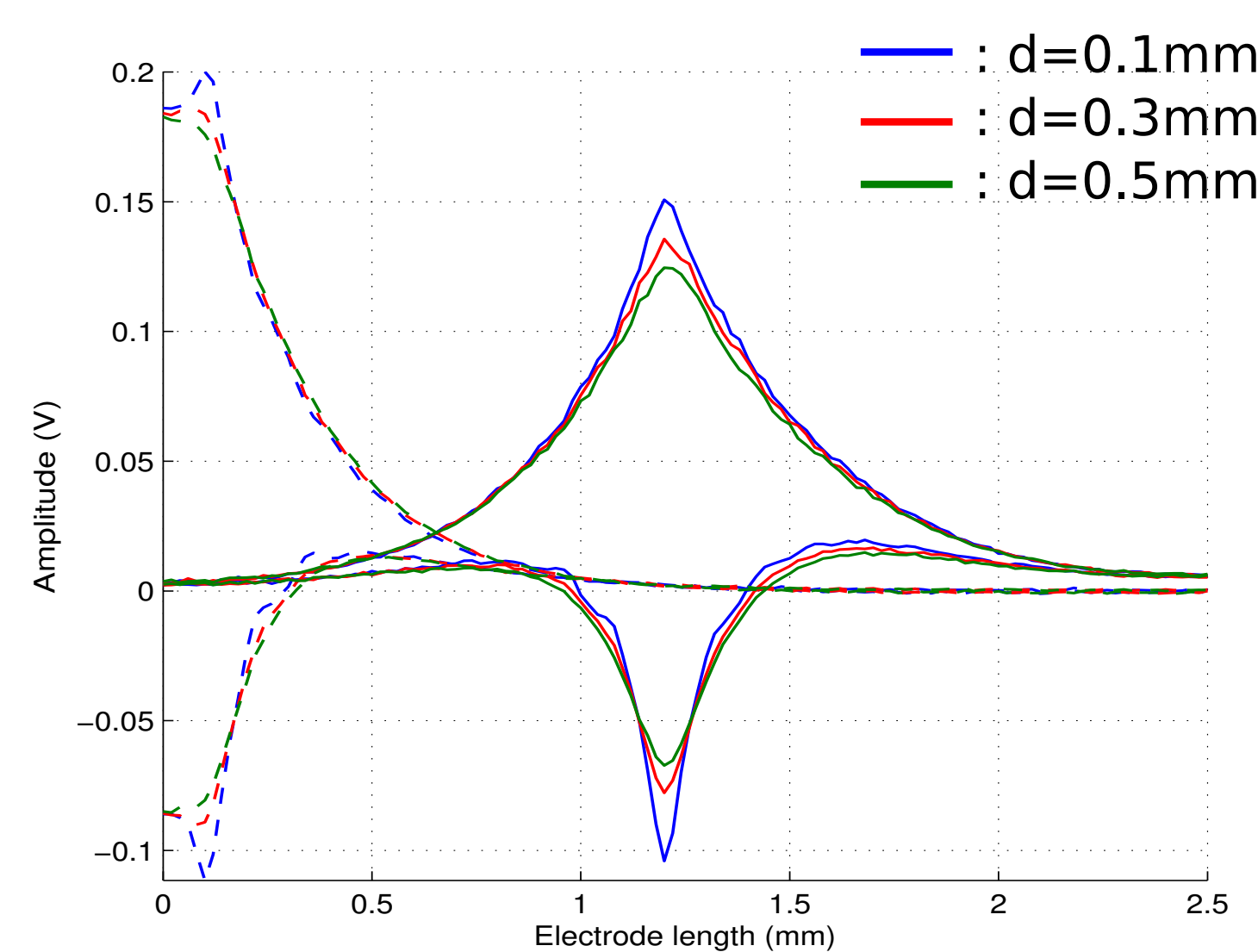

Figure 5. Voltage distribution along the electrode array.  $d$  is the radial distance from the electrode.

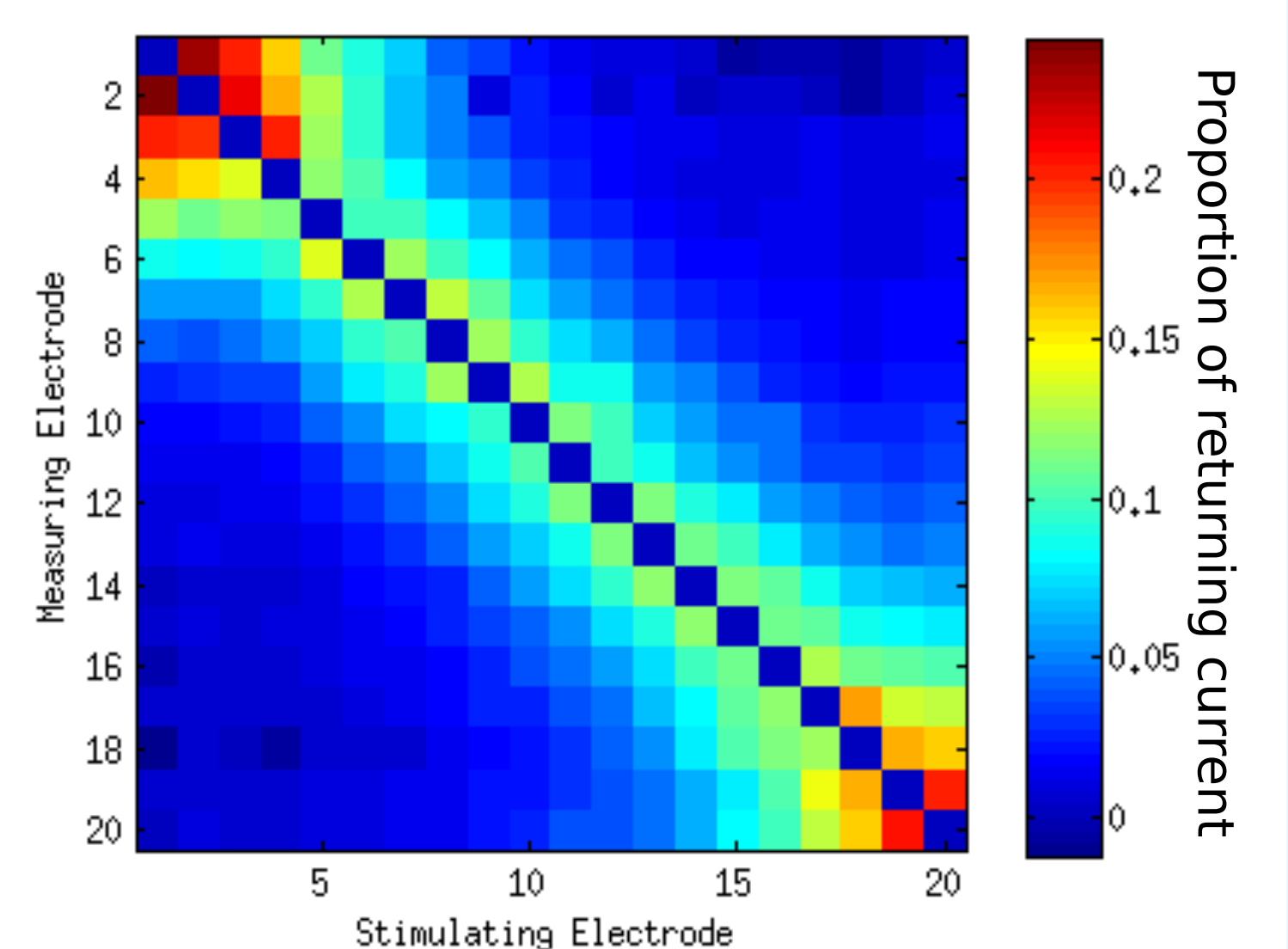

Figure 6. Returning current distribution from in situ measurements

## Conclusion

Compared with common ground stimulation, multi-mode grounding shows better consistency in the stimulation amplitudes across different electrodes. In terms of spatial voltage distribution, the stimulation phase is between the common ground and monopolar while the passive discharge phase is similar to tripolar stimulation. In situ measurements show around 25% of the stimulation current returns through the reference electrode.