

Development of Energy Monitoring System for SmartGrid Consumer Application

Peteris Apse-Apsitis¹, Ansis Avotins¹, Leonids Ribickis¹ and Janis Zakis²

¹ Riga Technical University, Institute of Industrial Electronics and Electrical Engineering,
Kronvalda street 1-315, LV-1010, Latvia

² Tallinn University of Technology, Department of Electrical Drives and Power Electronics,
Ehitajate tee 5, 19086 Tallinn, Estonia

Abstract. The number of electricity consuming equipment for existing household end-user is continuing to increase, and some residential buildings already consume more energy than existing building regulations prescribe. The uprising SmartGrid technology with alternative energy sources could be a key to solve this problem, but it is demanding also for a “smarter” consumer with ability to monitor and manage his loads. Such a monitoring system can also improve energy efficiency, as it can change consumer non-saving habits, by teaching him possibilities where the energy can be saved. Therefore the paper is devoted to development of new concept of household energy consumption monitoring system. Due to new approach of energy monitoring, the costs of needed metering equipment and total metering system are lowered. The proposed method provides energy consumption apportionment between consumers instead of precise energy consumption metering for each consumer type.

Keywords: energy efficiency, energy monitoring, signal processing, wireless communication.

1 Introduction

Existing dwellings consume about 3 times more energy than it is prescribed in the current Latvian building regulations, which were developed before households became available with wide range of electrical appliances (see Fig.1.), thus greatly contributing to the electrical load increase and network overloading. According to official data from local electrical energy supplier A/S Latvenergo and Riga Energy Agency [1], comparing the year 2007 and 2003, the electrical energy consumption has increased by 11 %, and is expected to continue to increase. According to data of the A/S Latvenergo, consumption in 2010 industry sector grew by 5.3 %, but due to economical crisis and increase of electricity rates, consumption in households reduced by 3 %. Fig. 2 shows that small countries like Latvia and Estonia are facing the same increase in electricity consumption tendency as other countries all over the world [2].

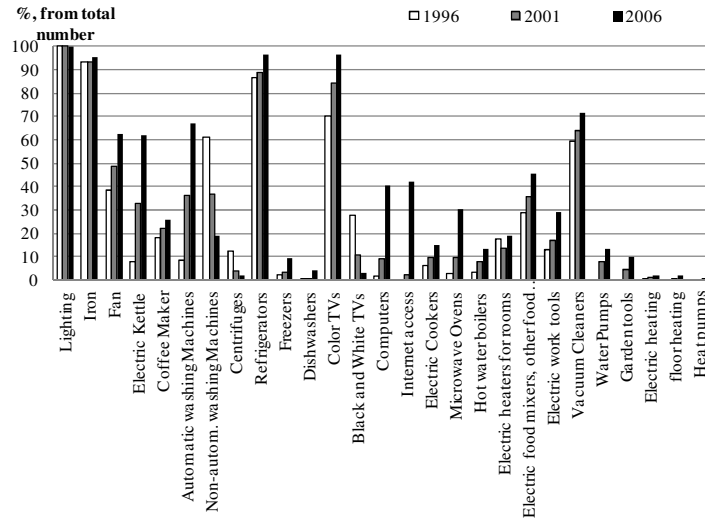

Fig. 1. Availability of electrical equipment in households in Latvia.

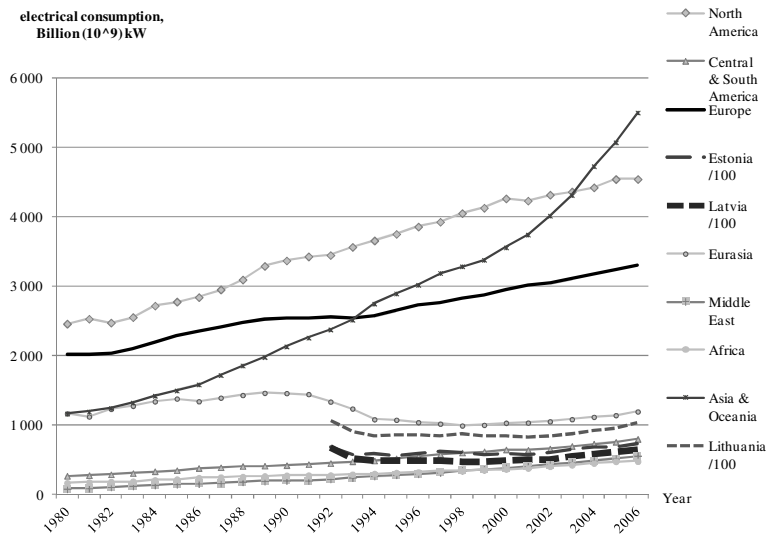

Fig. 2. World total electricity consumption 1980-2006.

In order to achieve global goals of energy efficiency, additional economic and political stimulators will be needed to change non-saving energy consumer habits of conservative household, residential building in cities or rural region end-user. One of such economical stimulator is natural continuous rise of price for electricity, as it is connected with limited availability of fossil fuels. As the prices for electrical energy

are increasing, and also availability of renewable energy sources in households, the idea of Smart Metering Systems and Smart Plugs in recent years got attention from both sides – energy supplier and consumer, as it could greatly contribute to energy consumption reduction, as shows research done by authors of articles [3, 4], by changing the habits of consumer, and thus creating more stable power grid in future. But in order to solve this problem, the end-user must be informed about his possibilities to save energy, which could be reached by implementing smart metering systems with graphical indicators on screen, or visualization on PC with help and tips for possible solutions of energy consumption reduction possibilities of each consuming device.

2 Contribution to Value Creation

Each typical household or office has simple metering system as shown in Fig. 3. with just one electrical energy measuring device from electricity supplier. Regardless that there are many energy consumer types ($P_1...P_n$) - TVs, music, fridges, microwaves, washing machines, heaters, boilers, computers, lighting (P_2) etc, it shows just total energy consumption and without additional metering devices or special calculations, proper energy consumption of each consumer device cannot be obtained.

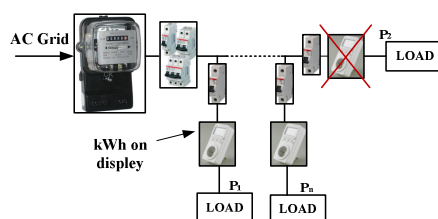

Fig. 3. Existing metering system.

To obtain precise energy consumption about each particular electrical device or group of them, additional metering devices are needed (see Fig.3.), but consumer like lighting can be measured just at input. As the typical household nowadays has at least 8-10 regular electricity consuming devices, and as the digital metering devices, that can be plugged into electrical socket cost around 16-30 euro (EUR), the investment of 171 to 285 EUR for such monitoring can be questionable for typical end-user. Another problem is that typical end-user does not have educational background to properly understand meanings of W, VA, VAr, kW, kWh, A, V and $\cos \varphi$ values visualized on the typical digital socket metering device display, thus the main focus should lie on how much “EUR” is consumed right now and in time period. Thus it can be concluded, that in order to “smarten” or convince end-user to use smart meters, they should be cheaper and able to give much direct and understandable message to end-user. Technically metering device should have also small dimensions, so that it could be integrated into back of wall socket.

2.1 Concept of Proposed Energy Monitoring System for End-User

The main idea is to provide energy consumption apportionment between consumers instead of precise energy consumption metering for each consumer type, as it could decrease the price of measuring elements. The distance between “central measurement point”, and “monitoring point” typically is less than 100 m, the voltage $u(t)$ practically is the same for each consumer and energy consumption can be characterized by just monitoring each consumer current $i(t)$ value, and central measurement point, which makes precise measurements of $u(t)$, $i(t)$ true root mean square (rms) values, receives relative current values from monitoring device, via wireless or power line communications, and makes indicative visualization of energy consumption per consumer on display or sends it to PC. Here 2.5 % - 5 % precision is enough for monitoring task and such precision corresponds to 80 sec or 180 sec consumer state “ON”. Energy consumer power typically is within range from 10 W up to 2250 W (up to 10 A), consumers have R or RL (also RC) load characteristics, current and voltage graphs are sinusoidal under normal conditions.

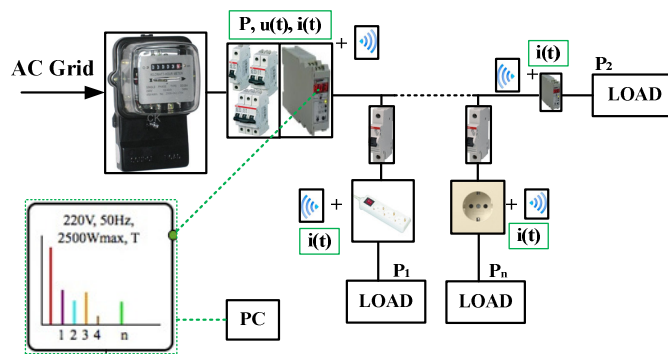

Fig.4. Block diagram of proposed energy monitoring method.

In order to get measurements and relative current value distribution in total energy consumption, the central measurement point is measuring precisely both voltage and current values, and measurements are synchronized in time with each monitoring measurement point, which measures only current value, at the exact monitoring point.

3 Power Measurement and Calculation Methods

Electrical power contains active and reactive components and they correspond to each other via $\cos \varphi$. Energy supplier places bill just for active component consumption in the most of cases for individuals and legal persons, for example in Latvia charges for reactive energy, when $\tan \varphi$ is greater than 0.4 ($\cos \varphi < 0,929$) and with allowed load 100 kW and more, is additional 0.003 Ls/kVArh. Therefore just active power measurement and visualization to end-user is actually needed.

3.1 Sinusoidal Current Consumers

For sinusoidal current consumers, active power values can be calculated from equations (1, 2):

$$P = U \times I \times \cos \varphi . \quad (1)$$

$$P_m = I_m \times \sin(\omega t) \times U_m \times \sin(\omega t) = \frac{I_m \times U_m \times [1 - \cos(2\omega t)]}{2} \quad (2)$$

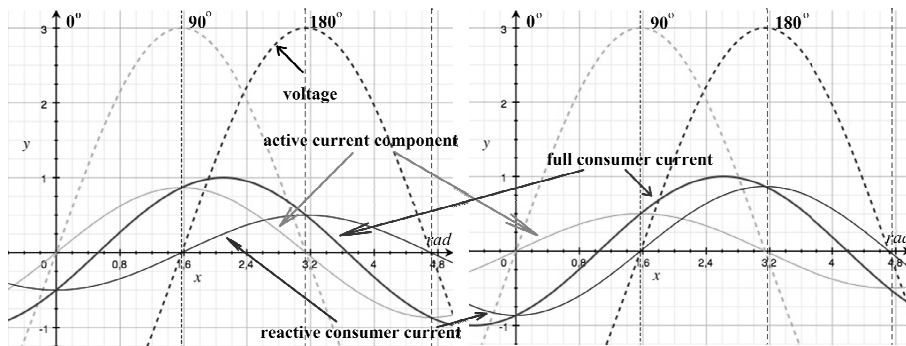

Fig.5. Voltage, active, reactive and full current graphs, where a) $\cos\varphi=0,5$; $\varphi=60$; b) $\cos\varphi=0,866$; $\varphi=30$.

Fig.5. shows that in sinusoidal consumer cases or in cases of consuming devices that are equipped with power supplies with Power Factor Correction circuit, it is possible to determine that active current max value (amplitude) is full current value measured at $1/4$ period (90°) or $3/4$ period (270°) and reactive current max value is full current value measured at $1/2$ period (180°) or period (0° or 360°). The technical solution and operation diagrams of electrical consumption monitoring device, for sinusoidal current consumer case, in more detail is described in previous research of authors [5]. The key element is wireless signal transceiver, where to fulfill the low-cost problem, a radio frequency transceiver with SC2262 encoder and SC2272 decoder is chosen.

3.2 Non-sinusoidal Current Consumers

In case of non-sinusoidal current consumers like average PC or laptop (see Fig. 6) power supplies, it is obvious, that a different power calculation method is needed than for sinusoidal current consumers. Instant energy calculations are used to determine periodical load alternating current power consumption. Overall known expression determine relationship between DC supply power, current and voltage:

$$P_{load} = (I_{load})^2 \times R_{load} . \tag{3}$$

Where P_{load} - DC load power consumption, I_{load} - DC load current, R_{load} - DC load resistance. DC load energy W consumption is characterized as power consumption over time period:

$$W = P_{load} \times T = (I_{load})^2 \times R_{load} \times T . \tag{4}$$

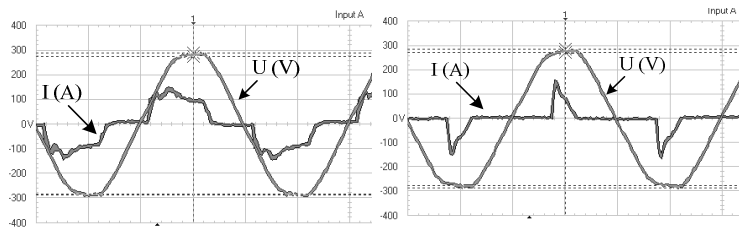

Fig.6. Waveforms of consumed voltage and current of PC (on left) and laptop (on right).

AC load instant energy w consumption also is characterized as power consumption over time period via instant AC current values:

$$dw_t = (i)^2 \times R_{load} \times dt . \tag{5}$$

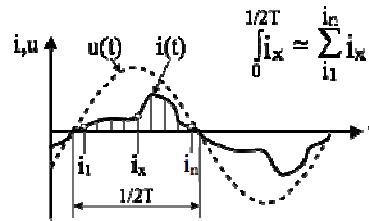

Fig. 7. Half period calculations for symmetrical non-sinusoidal current consumption.

AC load energy W is integrated instant energy value dw_t over AC half-period T for sinusoidal and non-sinusoidal current forms. Half-period integration can be applied for symmetrical AC current consumption graph (see Fig.7). Integration can be replaced and characterized by summary value of discrete energy values over half period.

$$W = \int_0^{1/2} i_x dt \approx \sum_{i1}^{in} i_x . \tag{6}$$

Here we are talking about power consumption monitoring or about percentage of each consumer power consumption in overall power consumption.

4 Technical Solution

The power measurement block diagram for each monitoring point device is shown in Fig. 8. As it can be seen, a low side shunt in series with load for current measurement is used. Zero-cross detection is needed for detecting half-period, and rectifier is special design rectifier based on operational amplifiers, widely used in audio applications, to transfer AC signal as DC signal directly to microprocessor, which is controlling transmitter and receiver for wireless data exchange between central measurement point and monitoring points.

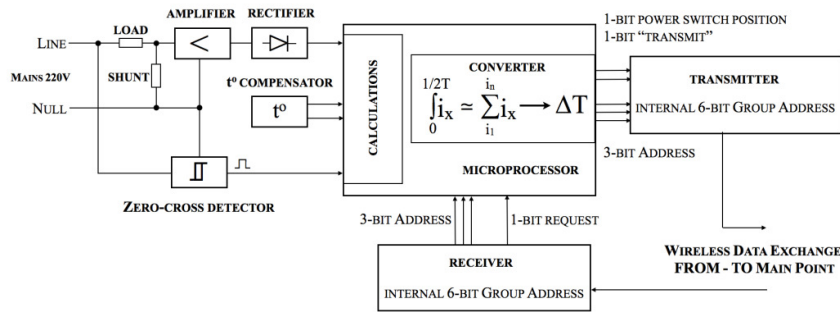

Fig.8. Diagram of technical solution for monitoring point.

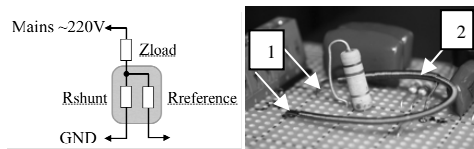

Fig.9. Copper Rshunt (1) and Rreference resistor (2) winding.

Shunt was used as current sensor (see Fig. 9), and dissipated power in shunt must be taken in to account and this fact reduce shunt value and make more difficult to read voltage drop on it for low consumer energy (power). Unfortunately other current sensors like Hall effect are more expensive, typically 3-8 EUR/piece and cannot be applied in this case, as the goal is to get low-cost measurement device, the shunt resistors like ERJ-M1WSJ8M0U, PMR50HZPJU8L0, or similar, has price from 0,30-2.00 EUR, which is also significant price [7]. To decrease current measurement circuit price ordinary copper wire (see Fig.9.) and resistance controlled gain of the amplifier was chosen instead. Ordinary copper wire is characterized by resistivity $\rho = 1.68 \cdot 10^{-8} \Omega$ (at 20 deg/C) and temperature coefficient 0.0039 K^{-1} . So, for example, resistance change varies from 0.00310Ω (at 0 deg/C) to 0.00388Ω (at 60 deg/C), or even more than 25%, thus resulting incorrect measurements. To exclude this, a reference resistor to control amplifier gain is applied. Reference resistor is made from copper and is close to shunt in the same housing.

Table 1. Temperature Influence on Shunt Resistor.

Temperature, °C	Amplifier output without compensation, mV	Amplifier output with compensation, mV
30	19.2	17.38
60	21.4	17.7
Difference, %	10.3 %	1.8 %

For data processing, storage and computing tasks, a system described in previous research of authors [5] can be implemented. Most of the systems available on market [6,7] (price varies from 14-429 EUR) can be used to monitor energy consumption, but not in Smart Grid context, as they don't allow sending collected data to user (PC) and as feedback to energy distributing company.

5 Conclusions

Described method allows designing and implementing low cost consumed energy monitoring for several consumers. Achieved price level is 4.55- 4.70 EUR per measuring point and 29.88 – 32.77 EUR per main measurement point unit, with overall costs tending to be less than ~71 EUR and it is acceptable for average household or small office. Further tasks are a development of communication protocol and interface between main measurement point and meter of energy distributing company. Proposed system has been submitted to the European Patent Office, thus further detailed description of the system will be available in authors next scientific papers.

References

1. Golunovs J.: Riga household specific electrical loads – planning instrument for improvement of energy efficiency, Energy and Automation, ed. 10, in Latvian, (2008)
2. EIA 2008: Energy Information Administration (U.S.), International Energy Annual 2006, Posted: 8 December 2008. Available at www.eia.doe.gov/iea/, 22. March 2011.
3. Choi, T.S., Ko, K.R., Park, S.C., Jang, Y.S., Yoon, Y.T., Im, S.K.: Analysis of energy savings using smart metering system and IHD (in-home display), Transmission & Distribution Conference & Exposition: Asia and Pacific, vol., no., pp.1--4, 26-30 (2009)
4. Maity, T., Das, P.S.: Intelligent Online Measurement and Management of Energy Meter Data through Advanced Wireless Network, Devices and Communications (ICDeCom), 2011 International Conference on , vol., no., pp.1--4, 24-25, (2011)
5. Apsitis-Apse, P., Avotins, A., Ribickis, L.: Concept of Low-Cost Energy Monitoring System for Household Application, 53International symposium Elmar,14-16. Zadar Croatia, pp. 149--152, (2011)
6. Stein, L.F., Enbar, N.: Direct Energy Feedback Technology Assessment for Southern California Edison Company, EPRI Solutions, Inc. (2006)
7. WEB catalogues, https://www.elfa.se/elfa3~lv_lv/elfa; <http://lv.farnell.com>. Last checked at November 27, 2011.