



HAL
open science

A relation on 132-avoiding permutation patterns

Natalie Aisbett

► **To cite this version:**

Natalie Aisbett. A relation on 132-avoiding permutation patterns. *Discrete Mathematics and Theoretical Computer Science*, 2015, Vol. 17 no.2 (2), pp.285-302. 10.46298/dmtcs.2141 . hal-01349056

HAL Id: hal-01349056

<https://inria.hal.science/hal-01349056>

Submitted on 26 Jul 2016

HAL is a multi-disciplinary open access archive for the deposit and dissemination of scientific research documents, whether they are published or not. The documents may come from teaching and research institutions in France or abroad, or from public or private research centers.

L'archive ouverte pluridisciplinaire **HAL**, est destinée au dépôt et à la diffusion de documents scientifiques de niveau recherche, publiés ou non, émanant des établissements d'enseignement et de recherche français ou étrangers, des laboratoires publics ou privés.

A relation on 132-avoiding permutation patterns

Natalie Aisbett

School of Mathematics and Statistics, University of Sydney, Australia

received 9th June 2013, revised 14th Jan. 2014, 16th Feb. 2014, 24th Mar. 2015, 15th May 2015, accepted 12th Nov. 2015.

A permutation σ *contains* the permutation τ if there is a subsequence of σ order isomorphic to τ . A permutation σ is τ -*avoiding* if it does not contain the permutation τ . For any n , the *popularity* of a permutation τ , denoted $A_n(\tau)$, is the number of copies of τ contained in the set of all 132-avoiding permutations of length n . Rudolph conjectures that for permutations τ and μ of the same length, for all n we have $A_n(\tau) \leq A_n(\mu)$ if and only if the spine structure of τ is less than or equal to the spine structure of μ in refinement order. We prove one direction of Rudolph's conjecture by showing that if the spine structure of τ is less than or equal to the spine structure of μ , then for all n , $A_n(\tau) \leq A_n(\mu)$. Furthermore, we show that $A_n(\tau) < A_n(\mu)$ when n is greater than the length of τ and μ . We disprove the opposite direction by giving a counterexample, and hence disprove the conjecture.

Keywords: permutations, permutation pattern, popularity

1 Introduction

A permutation σ *contains* the permutation τ if there is a subsequence of σ order isomorphic to τ . In this case we say that τ is a *pattern* of σ . A permutation σ is τ -*avoiding* if it does not contain the permutation τ . The *popularity* of a permutation τ in length n 132-avoiding permutations (defined more rigorously in Section 2), denoted $A_n(\tau)$, is the number of copies of τ contained in the set of all 132-avoiding permutations of length n . The question of pattern popularity within permutations that avoid some pattern was first asked by Joshua Cooper on his webpage [4]. Here he raised the question: what is the expected number of copies of a pattern in a randomly chosen pattern avoiding permutation? This problem was first tackled by Bóna in [1], where he proved that for all permutation patterns τ of length k and for any $n \geq k$ we have

$$A_n(12 \dots k) \leq A_n(\tau) \leq A_n(k(k-1) \dots 1).$$

He then extended this result in [2] to show that for all $n \geq 3$

$$A_n(213) = A_n(231) = A_n(312).$$

In [5], Homberger studied Cooper's question for patterns of length 3 in 123-avoiding permutations.

Every 132-avoiding permutation τ has an associated binary tree $T(\tau)$ (defined in Section 4) which in turn has an associated partition called its *spine structure*. In [6], Rudolph extended the results of Bóna to show that:

Theorem 1.1 ([6, Theorem 16]). *For any 132-avoiding permutations τ and μ of length k , if $T(\tau)$ and $T(\mu)$ have the same spine structure, then for all $n \geq k$ we have $A_n(\tau) = A_n(\mu)$.*

Chua and Sankar have since shown in [3] that if $A_n(\tau) = A_n(\mu)$ for all n , then $T(\tau)$ and $T(\mu)$ have the same spine structure.

In [6], Rudolph conjectured the following:

Conjecture 1.2 ([6, Conjecture 21]). *Given patterns τ and μ , for all n we have $A_n(\tau) \leq A_n(\mu)$ if and only if the spine structure of $T(\tau)$ is less than or equal to the spine structure of $T(\mu)$ in refinement order.*

In Theorem 4.6 we prove one direction of Conjecture 1.2, by showing that if the spine structure of $T(\tau)$ is less than or equal to the spine structure of $T(\mu)$ in refinement order, then $A_n(\tau) \leq A_n(\mu)$. It should be mentioned that Theorem 4.6 has previously been proven by Rudolph (unpublished). In Proposition 4.8, we strengthen this result by showing that if τ and μ have length less than n and the spine structure of $T(\tau)$ is less than the spine structure of $T(\mu)$ in refinement order, then $A_n(\tau) < A_n(\mu)$. Then, in Corollary 5.2, we disprove Conjecture 1.2 by showing that there exist permutations τ and μ such that for all n we have $A_n(\tau) \leq A_n(\mu)$, whereas $T(\tau)$ and $T(\mu)$ are incomparable in refinement order.

We now give an outline of how the paper leads into the proof of the main theorem, Theorem 4.6. Chapter 2 introduces the main definitions that are used in the paper. Chapter 3 introduces a “move” that can be performed on a 132-avoiding permutation τ , which gives another 132-avoiding permutation μ of the same length as τ . Theorem 3.5 is used to show that $A_n(\mu) \geq A_n(\tau)$, and is the main theorem in Chapter 3. In Chapter 4, we describe a well-known bijection between binary trees and 132-avoiding permutations. In this paper, this bijection sends the permutation τ to the tree $T(\tau)$. We describe this bijection in order to define the spine structure of 132-avoiding permutations, which is a property of their corresponding binary trees. Note that two distinct 132-avoiding permutations may have the same spine structure. Then, in Proposition 4.4, we show that if ϕ is obtained from σ by the popularity increasing move, then the spine structure of ϕ is greater than the spine structure of σ in refinement order. We then show (see Proposition 4.5 and the proof of Theorem 4.6) that if the spine structure of a 132-avoiding permutation ϕ is greater than the spine structure of another 132-avoiding permutation σ , then there is a permutation τ with the same spine structure as σ , and a permutation μ with the same spine structure as ϕ , such that μ is obtained from τ by the popularity increasing move. Since popularity is equal for permutations with the same spine structure (Theorem 1.1), this proves the main theorem of this paper, Theorem 4.6.

Acknowledgements

I would like to thank my PhD supervisor Anthony Henderson for helpful conversations.

2 Definitions

Let $[n]$ denote the set of integers $\{1, 2, \dots, n\}$. Let $\sigma = \sigma_1 \dots \sigma_n$ denote a permutation of $[n]$ written in one-line notation. The permutation σ contains the pattern $\tau = \tau_1 \dots \tau_k$ if there exist $1 \leq i_1 < i_2 < \dots < i_k \leq n$ such that for any $1 \leq s, t \leq k$ we have $\sigma_{i_s} < \sigma_{i_t}$ when $\tau_s < \tau_t$. A permutation pattern $\tau = \tau_1 \dots \tau_k$ is of length k . A 132-avoiding permutation is a permutation that does not contain the pattern 132. We denote the set of all permutations of $[n]$ that are 132-avoiding by $S_n(132)$.

Suppose that $\tau = \tau_1 \dots \tau_k$ is a permutation of length k for some integer $k \leq n$, and suppose that $\sigma \in S_n(132)$. Let $f(\sigma, \tau)$ denote the number of copies of τ contained in σ . For example, $f(53421, 321) = 7$ since the subsequences 532, 531, 542, 541, 521, 321 and 421 give rise to the pattern 321. The *popularity* of a pattern $\tau \in S_k(132)$ in length n 132-avoiding permutations, denoted $A_n(\tau)$, is given by

$$A_n(\tau) := \sum_{\sigma \in S_n(132)} f(\sigma, \tau).$$

Permutations τ and μ each of length k are *equipopular* if for all n , $A_n(\tau) = A_n(\mu)$. Note that if a 132-avoiding permutation contains a pattern, then that pattern must also be a 132-avoiding permutation. There is $0! = 1$ permutation of the empty set, which is of length 0. It certainly avoids 132, and hence belongs to $S_0(132)$, so that $|S_0(132)| = 1$. When τ is the length 0 permutation we take by convention $A_n(\tau) = |S_n(132)|$.

Suppose $\sigma_1 \dots \sigma_n \in S_n(132)$ and that $\sigma_{s_1} \dots \sigma_{s_k}$ (where $s_1 < \dots < s_k$) gives rise to a permutation pattern τ . Then we say that $\{\sigma_{s_1}, \dots, \sigma_{s_k}\}$ are the elements in this occurrence of τ , and for all $i \in [k]$ we say that σ_{s_i} occurs as τ_i .

3 A popularity increasing move

In this section we describe a move on 132-avoiding permutations. We show that for all n , this move can be applied to any permutation in $S_n(132)$ other than $n(n-1) \dots 1$, and that it results in another 132-avoiding permutation. We then show, in Theorem 3.5, that this move produces a new permutation whose popularity is greater than or equal to that of the original permutation.

Observe that if $\sigma = \sigma_1 \dots \sigma_n$ is a 132-avoiding permutation, and if $\sigma_j = n$, then for all $i < j$ and for all $k > j$ we have $\sigma_i > \sigma_k$. In other words, all entries to the left of n are greater than all entries to the right of n .

Suppose that $\sigma = \sigma_1 \dots \sigma_n \in S_n(132)$, and that there are a pair of indices i, j with $i < j$, such that:

- $\sigma_i < \sigma_j$,
- for all integers α such that $\alpha < i$ we have $\sigma_\alpha > \sigma_j$,
- for all integers β such that $i < \beta < j$ we have $\sigma_\beta < \sigma_i$.

Then we may form a new permutation $\phi = \phi_1 \dots \phi_n$, where $\phi_1 \dots \phi_{i-1} = \sigma_1 \dots \sigma_{i-1}$, $\phi_i = \sigma_j$, $\phi_{i+1} \dots \phi_j = \sigma_i \dots \sigma_{j-1}$, and $\phi_{j+1} \dots \phi_n = \sigma_{j+1} \dots \sigma_n$. In other words, ϕ is obtained from σ by removing σ_j and inserting it before σ_i . Since σ is 132-avoiding, all elements in $\{\sigma_{j+1}, \dots, \sigma_n\}$ are either less than σ_i or greater than σ_j , hence we must have $\sigma_j = \sigma_i + 1$. We can therefore denote ϕ unambiguously by σ^{σ_j} .

Example 3.1. Let $\sigma = 865347129 \in S_9(132)$. Then σ^7 is defined, and is equal to 876534129. The permutation σ is shown below on the left, and σ^7 is shown below on the right.

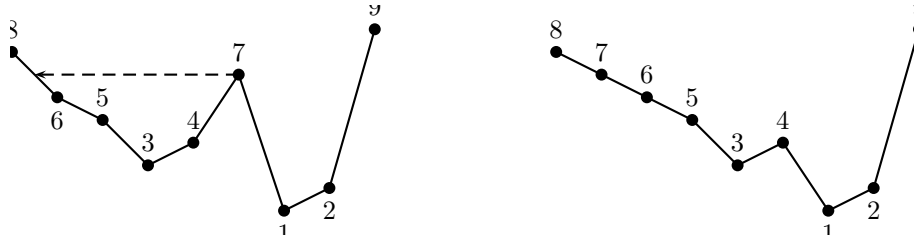

Note that if $\sigma \in S_n(132)$ and σ^{σ^j} is defined for some j , then σ can be broken into five parts (dependent on j) as follows:

- The set of numbers $\{\sigma_1, \dots, \sigma_{i-1}\}$, which we denote by L for left. Every number in L is greater than σ_j .
- σ_i .
- The set of numbers $\{\sigma_{i+1}, \dots, \sigma_{j-1}\}$, which we denote by M for middle (this set is empty if $j = i + 1$). Every number in M is less than σ_i .
- σ_j .
- The set of numbers $\{\sigma_{j+1}, \dots, \sigma_n\}$, which we denote by R for right. Each number in this set is either less than all numbers in the set $M \cup \sigma_i$, or is greater than σ_j .

Example 3.2. Let $\sigma = 865347129 \in S_9(132)$ (see Example 3.1), and let $\sigma_j = 7$. Then $L = \{8\}$, $M = \{5, 3, 4\}$, and $R = \{1, 2, 9\}$.

Proposition 3.3. Suppose $\sigma \in S_n(132)$ and that for some j , $\phi = \sigma^{\sigma^j}$ is defined. Then $\phi \in S_n(132)$.

Proof: Suppose for a contradiction that $\phi \notin S_n(132)$. Then σ_j must occur as an element in a 132 pattern in ϕ . If σ_j occurs as 1, then the elements that occur as 3 and 2 must be contained in R . This is the desired contradiction that σ would not be 132-avoiding, since the same triple of integers form a 132 pattern in σ . If σ_j occurs as 3 or 2 we also have a contradiction since $\sigma_1 \dots \sigma_{i-1}$ are all greater than σ_j . \square

Proposition 3.4. For any $n \geq 2$ and any $\sigma \in S_n(132) - \{n(n-1) \dots 1\}$, there exists an index j such that σ^{σ^j} is defined.

Proof: Since σ is not the permutation $n(n-1) \dots 1$, there is a minimal j such that $\sigma_j > \sigma_{j-1}$. Then permutation σ^{σ^j} is defined since $\sigma_1 \dots \sigma_{j-1}$ is decreasing. \square

Suppose $\tau \in S_k(132)$ and n is an integer greater than or equal to k . Let $\mathcal{O}_n(\tau)$ denote the set of occurrences of τ in permutations $\sigma \in S_n(132)$ such that n is an element in the occurrence, and let $\mathcal{O}'_n(\tau)$

be the set of occurrences of the pattern τ in permutations $\sigma \in S_n(132)$ such that n is not an element in the occurrence. Then

$$A_n(\tau) = |\mathcal{O}_n(\tau)| + |\mathcal{O}'_n(\tau)|.$$

We denote an occurrence of τ in some $\sigma = \sigma_1 \dots \sigma_n$ by a pair $(\sigma, \sigma_{s_1} \dots \sigma_{s_k})$ in which $\{\sigma_{s_1}, \dots, \sigma_{s_k}\}$ are the elements in the occurrence of τ .

Given permutations τ of length k and μ of length l , we define permutations $\tau \oplus \mu$ and $\tau \ominus \mu$ each of length $k + l$ as follows

$$(\tau \oplus \mu)_i = \begin{cases} \tau_i, & \text{if } 1 \leq i \leq k, \\ \mu_i + k, & \text{if } k + 1 \leq i \leq k + l, \end{cases}$$

$$(\tau \ominus \mu)_i = \begin{cases} \tau_i + l, & \text{if } 1 \leq i \leq k, \\ \mu_i, & \text{if } k + 1 \leq i \leq k + l. \end{cases}$$

Theorem 3.5. *Suppose that $\mu, \tau \in S_k(132)$ and that for some j , $\mu = \tau^{\tau_j}$. Then for all $n \geq k$ we have $A_n(\mu) \geq A_n(\tau)$.*

Proof: We proceed by induction. By definition, if $\mu = \tau^{\tau_j}$ for some j , then μ and τ have length greater than or equal to 2. Hence, to prove the base case, we need to prove that if $\mu = \tau^{\tau_j}$ for some j , where μ is of length 2, then $A_2(\mu) \geq A_2(\tau)$. This is true since $A_2(\tau) = A_2(\mu) = 1$. Now assume by induction that $A_{n'}(\mu) \geq A_{n'}(\tau)$ holds for every pair μ and τ of length k' with $\mu = \tau^{\tau_j}$ for some j , where $k' \leq k$ and $n' < n$, or $k' < k$ and $n' \leq n$. Now suppose that $\mu = \tau^{\tau_j}$ for some μ, τ and j , where $\mu \in S_k(132)$. We will show that $A_n(\mu) \geq A_n(\tau)$.

Note that the sets L , M and R that we will mentioned in this proof are subsets of $\{\tau_1, \dots, \tau_k\}$. We will consider occurrences of the pattern τ contained in permutations $\sigma \in S_n(132)$. We will consider the following two cases separately.

- a) The set of occurrences of τ contained in $\mathcal{O}'_n(\tau)$.
- b) The set of occurrences of τ contained in $\mathcal{O}_n(\tau)$. In this case n may occur as τ_j if and only if L is empty, and the elements in R are all less than the elements in $M \cup \{\tau_i\}$.

To show that $A_n(\mu) \geq A_n(\tau)$ we first show, in part a), by induction that $|\mathcal{O}'_n(\tau)| \leq |\mathcal{O}'_n(\mu)|$, and we then show, in part b), that $|\mathcal{O}_n(\tau)| \leq |\mathcal{O}_n(\mu)|$.

First we consider case a), i.e., occurrences of τ in $\mathcal{O}'_n(\tau)$. Suppose that for some $\xi \leq i$, there exists at least one occurrence of τ in some permutation $\sigma \in S_n(132)$, so that when σ is written in one-line notation:

- n is to the left of the element that occurs as τ_ξ , and
- if $\xi \neq 1$, then the element that occurs as $\tau_{\xi-1}$ is to the left of n .

Given any such occurrence in which $\sigma_{\alpha+1} = n$, the pattern which is order isomorphic to the word $\tau_1 \dots \tau_{\xi-1}$ occurs within the permutation which is order isomorphic to the word $\sigma_1 \dots \sigma_\alpha \in S_\alpha(132)$, and the pattern $\tau_\xi \dots \tau_k$ occurs within the permutation $\sigma_{\alpha+2} \dots \sigma_n \in S_{n-\alpha-1}(132)$. Also, given an occurrence of the pattern which is order isomorphic to the word $\tau_1 \dots \tau_{\xi-1}$ within a permutation θ in $S_\alpha(132)$, and an occurrence of $\tau_\xi \dots \tau_k$ within a permutation ϕ in $S_{n-\alpha-1}(132)$, we may concatenate these occurrences to form an occurrence of τ in the permutation $\sigma = (\theta \oplus 1) \ominus \phi$. Hence, the number of such occurrences of τ in permutations $\sigma \in \mathcal{O}'_n(\tau)$ in which $\sigma_{\alpha+1} = n$ is given by

$$A_\alpha(\tau_1 \dots \tau_{\xi-1})A_{n-\alpha-1}(\tau_\xi \dots \tau_k).$$

Summing this over all possible values of α gives the total number of such occurrences (with respect to this value of ξ) of $\tau \in \mathcal{O}'_n(\tau)$:

$$\sum_{\alpha=\xi-1}^{n+\xi-k-2} A_\alpha(\tau_1 \dots \tau_{\xi-1})A_{n-1-\alpha}(\tau_\xi \dots \tau_k).$$

In the case that $\xi = 1$, so that $\tau_1 \dots \tau_{\xi-1}$ is the empty word, recall that the term $A_\alpha(\tau_1 \dots \tau_{\xi-1})$ equals $|S_\alpha(132)|$, and that $|S_0(132)| = 1$. We will now consider, for this value of ξ , occurrences of μ is permutation in $\mathcal{O}'_n(\mu)$ in which n lies between $\mu_{\xi-1}$ and μ_ξ (or to the left of μ if $\xi = 1$). By a similar argument, the number of such occurrences of μ in all possible $\sigma \in S_n(132)$ is the sum

$$\sum_{\alpha=\xi-1}^{n+\xi-k-2} A_\alpha(\mu_1 \dots \mu_{\xi-1})A_{n-1-\alpha}(\mu_\xi \dots \mu_k).$$

Now, $\mu_1 \dots \mu_{\xi-1} = \tau_1 \dots \tau_{\xi-1}$, so that $A_\alpha(\mu_1 \dots \mu_{\xi-1}) = A_\alpha(\tau_1 \dots \tau_{\xi-1})$ for all α in the summation. By induction, we have that

$$A_{n-1-\alpha}(\tau_\xi \dots \tau_k) \leq A_{n-1-\alpha}(\mu_\xi \dots \mu_k)$$

for all α in the summation, since $\mu_\xi \dots \mu_k = \tau_\xi \dots \tau_k^{\tau_j}$. Therefore

$$\begin{aligned} & \sum_{\alpha=\xi-1}^{n+\xi-k-2} A_\alpha(\tau_1 \dots \tau_{\xi-1})A_{n-1-\alpha}(\tau_\xi \dots \tau_k) \\ & \leq \sum_{\alpha=\xi-1}^{n+\xi-k-2} A_\alpha(\mu_1 \dots \mu_{\xi-1})A_{n-1-\alpha}(\mu_\xi \dots \mu_k) \end{aligned}$$

holds for all $\xi \leq i$ such that n may lie between $\tau_{\xi-1}$ and τ_ξ .

Note that it is not possible for n to lie between $\tau_{\xi-1}$ and τ_ξ if $\xi \in \{i+1, \dots, j\}$. Suppose that for some $\xi \geq j$, there exists at least one occurrence of τ in some permutation $\sigma \in S_n(132)$, so that when σ is written in one-line notation:

- n is to the right of the element that occurs as $\tau_{\xi-1}$, and

- if $\xi - 1 \neq k$, then the element that occurs as τ_ξ is to the right of n .

For this value of ξ , we can again consider occurrences of μ is $\mathcal{O}'_n(\mu)$ in which n lies between $\mu_{\xi-1}$ and μ_ξ . Note that if $\xi - 1 = j$, then $\mu_{\xi-1} = \tau_{j-1}$. By a similar argument to that given when $\xi \leq i$, we can deduce that the number of such occurrences of the pattern τ is less than or equal to the number of such occurrences of the pattern μ . Since we have considered all possible occurrences of τ in $\mathcal{O}'_n(\tau)$, we have shown that

$$|\mathcal{O}'_n(\tau)| \leq |\mathcal{O}'_n(\mu)|.$$

We now consider case b), i.e., occurrences of τ in $\mathcal{O}_n(\tau)$. Recall that $\mathcal{O}_n(\tau)$ is the set of occurrences of τ in permutations in $S_n(132)$ in which n is an element of the occurrence. For this part, we will show that $|\mathcal{O}_n(\tau)| \leq |\mathcal{O}_n(\mu)|$ in two cases. The first case is when τ_j is not equal to k , and we prove this case by induction. The second case is when $\tau_j = k$, so that for all elements in $\mathcal{O}_n(\tau)$ we must have n occur as τ_j . In this case we define a map from $\mathcal{O}_n(\tau)$ to $\mathcal{O}_n(\mu)$ and show that this map is an injection.

Suppose that $\tau_j \neq k$, so that n may occur as an element in L or R only. Suppose that for some $\xi \leq i - 1$, there exists an occurrence of τ in which n occurs as τ_ξ . Then there exists an occurrence of μ in $\mathcal{O}_n(\mu)$ in which n occurs as μ_ξ . The number of such occurrences of the pattern τ in all possible $\sigma \in S_n(132)$ is

$$\sum_{\alpha=\xi-1}^{n+\xi-k-1} A_\alpha(\tau_1 \dots \tau_{\xi-1}) A_{n-1-\alpha}(\tau_{\xi+1} \dots \tau_k),$$

and the number of such occurrences of the pattern μ in all possible $\sigma \in S_n(132)$ is

$$\sum_{\alpha=\xi-1}^{n+\xi-k-1} A_\alpha(\mu_1 \dots \mu_{\xi-1}) A_{n-\alpha-1}(\mu_{\xi+1} \dots \mu_k).$$

Since $\tau_1 \dots \tau_{\xi-1} = \mu_1 \dots \mu_{\xi-1}$ we have that $A_\alpha(\tau_1 \dots \tau_{\xi-1}) = A_\alpha(\mu_1 \dots \mu_{\xi-1})$ for all α in the summation. By the inductive hypothesis $A_{n-1-\alpha}(\tau_{\xi+1} \dots \tau_k) \leq A_{n-1-\alpha}(\mu_{\xi+1} \dots \mu_k)$ for all α in the summation since $\mu_{\xi+1} \dots \mu_k = \tau_{\xi+1} \dots \tau_k^{\tau_j}$. Hence

$$\begin{aligned} & \sum_{\alpha=\xi-1}^{n+\xi-k-1} A_\alpha(\tau_1 \dots \tau_{\xi-1}) A_{n-1-\alpha}(\tau_{\xi+1} \dots \tau_k) \\ & \leq \sum_{\alpha=\xi-1}^{n+\xi-k-1} A_\alpha(\mu_1 \dots \mu_{\xi-1}) A_{n-\alpha-1}(\mu_{\xi+1} \dots \mu_k). \end{aligned}$$

Suppose that for some $\xi \geq j + 1$, that there is at least one occurrence of τ in $\mathcal{O}_n(\tau)$ in which n occurs as τ_ξ . Then there exists at least one occurrence of μ in $\mathcal{O}_n(\mu)$ in which n occurs as μ_ξ . By the same argument as in the case where $\xi \leq i - 1$, we have that the number of such occurrences of the pattern τ is less than or equal to the number of such occurrences of the pattern μ .

We now consider elements of $\mathcal{O}_n(\tau)$ in which n occurs as τ_j . Note that this case is possible if and only if $\tau_i = \tau_1$ (i.e., L is empty), and all elements of R are less than elements in $M \cup \tau_i$. For such τ we will define a map

$$\psi : \mathcal{O}_n(\tau) \rightarrow \mathcal{O}_n(\mu).$$

We will argue that this map is injective, and therefore, the number of such occurrences of the pattern τ is less than or equal to the number of such occurrences of the pattern μ .

Fix an element $(\sigma, \sigma_{s_1} \dots \sigma_{s_k}) \in \mathcal{O}_n(\tau)$ such that $\sigma_{s_j} = n$. Consider the earliest index $\alpha \in [s_j - 1]$ such that:

- the occurrence of the elements in $M \cup \{\tau_i\}$ in σ are in the set $\{\sigma_1, \dots, \sigma_\alpha\}$, and
- each element in $\{\sigma_1, \dots, \sigma_\alpha\}$ is greater than all the elements in the set $\{\sigma_{\alpha+1}, \dots, \sigma_n\} - \{\sigma_{s_j}\}$.

Note that there must exist such an index α since $s_j - 1$ satisfies the above two conditions. Note also that since $\sigma \in S_n(132)$, the elements $\sigma_{\alpha+1}, \dots, \sigma_{s_j-1}$ (we take this set to be empty if $\sigma_\alpha = \sigma_{s_j-1}$) are an interval in the set of integers $[n]$. Let u be the permutation pattern $\sigma_1 \dots \sigma_\alpha$, let v be the permutation pattern $\sigma_{\alpha+1} \dots \sigma_{s_j-1}$, and let w be the permutation pattern $\sigma_{s_j+1} \dots \sigma_n$. We let

$$\psi((\sigma, \sigma_{s_1} \dots \sigma_{s_k})) = (\bar{\sigma}, \bar{\sigma}_{t_1} \dots \bar{\sigma}_{t_k}),$$

where

$$\bar{\sigma} = ((v \oplus 1) \ominus u) \ominus w,$$

with the occurrence $\bar{\sigma}_{t_1}, \dots, \bar{\sigma}_{t_k}$ of μ in $\bar{\sigma}$ is given by n , followed by the entries in the patterns u and w in $\bar{\sigma}$ that give the occurrence of the elements

$$\tau_1, \dots, \tau_{j-1}, \tau_{j+1}, \dots, \tau_n$$

in u and w in σ (see Example 3.6).

Now $\bar{\sigma}$ is clearly in $S_n(132)$. To show that ψ is injective, we show that for any occurrence of μ in the image of this map, we can recover the occurrence of τ that mapped to it uniquely. Suppose $\psi((\sigma, \sigma_{s_1} \dots \sigma_{s_k})) = (\bar{\sigma}, \bar{\sigma}_{t_1} \dots \bar{\sigma}_{t_k})$, and consider the earliest index $\beta \in [n]$ such that:

- the occurrence of the elements in $M \cup \{\tau_i\}$ in $\bar{\sigma}$ are in the set $\{\bar{\sigma}_1, \dots, \bar{\sigma}_\beta\}$,
- the occurrence of the elements in R in $\bar{\sigma}$ are in the set $\{\bar{\sigma}_{\beta+1}, \bar{\sigma}_{\beta+2}, \dots, \bar{\sigma}_n\}$,
- each element in $\{\bar{\sigma}_1, \dots, \bar{\sigma}_\beta\}$ is greater than all the elements in the set $\{\bar{\sigma}_{\beta+1}, \dots, \bar{\sigma}_n\}$.

Note that there must exist such an index β since there was an index α that satisfied these conditions in σ . Suppose that $\bar{\sigma}_l = n$. Then the permutation pattern $\bar{\sigma}_1, \dots, \bar{\sigma}_{l-1}$ is denoted by v . We denote the permutation pattern $\bar{\sigma}_{l+1}, \dots, \bar{\sigma}_\beta$ by u , and we denote the permutation pattern $\bar{\sigma}_{\beta+1} \dots \bar{\sigma}_n$ by w . Then

$$\bar{\sigma} = ((v \oplus 1) \ominus u) \ominus w,$$

and the occurrence of τ that maps to $(\bar{\sigma}, \bar{\sigma}_{t_1} \dots \bar{\sigma}_{t_k})$ must be given by

$$\sigma = ((u \ominus v) \oplus 1) \ominus w,$$

where n occurs as τ_j , and the entries in u and w that corresponded to the occurrence of $\mu_2 \dots \mu_n$ in $\bar{\sigma}$ give the occurrence of $\tau_1 \dots \tau_{j-1} \tau_{j+1} \dots \tau_n$ in σ (see Example 3.6). This is exactly $(\sigma, \sigma_{s_1} \dots \sigma_{s_k})$. \square

Example 3.6. We give an example of the map ψ given in the proof of Theorem 3.5. Let $k = 6$ and let $n = 13$. Let τ be the permutation 534612, and let $\mu = \tau^6 = 653412$. Let

$$((11, 12, 8, 7, 9, 6, 10, 5, 4, 13, 2, 1, 3), (12, 7, 9, 13, 2, 3))$$

be an occurrence of τ in $\sigma = (11, 12, 8, 7, 9, 6, 10, 5, 4, 13, 2, 1, 3)$. The occurrence (σ, τ) is shown below in Figure 1(a), where we have included a dot above elements in the occurrence of τ . The index s_j is equal to 10, and $\sigma_{10} = 13$ occurs as $\tau_j = 6$. The pattern u is given by $(11, 12, 8, 7, 9, 6, 10)$, the pattern v is given by $(5, 4)$, and the pattern w is given by $(2, 1, 3)$. Then the occurrence of μ in the permutation $\bar{\sigma}$ is given by

$$((12, 11, 13, 9, 10, 6, 5, 7, 4, 8, 2, 1, 3), (13, 10, 5, 7, 2, 3)),$$

and is shown in Figure 1(b) below.

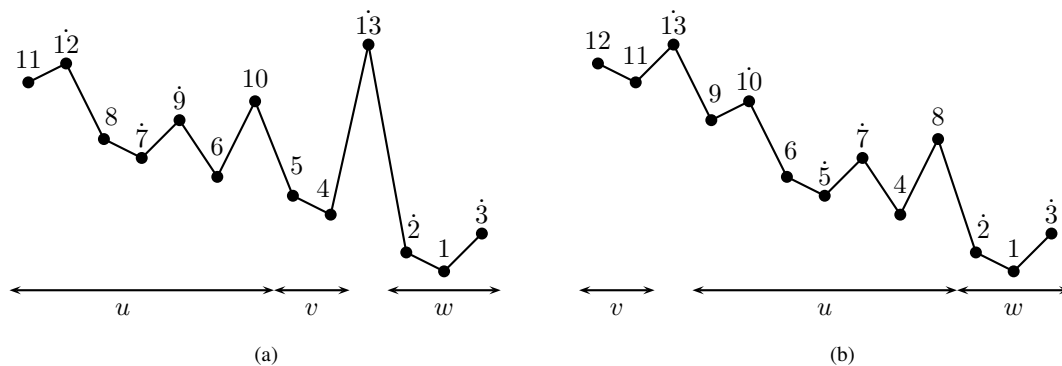

Fig. 1:

4 Proof of the main theorem

In this section, we prove the main theorem, Theorem 4.6. Before proving Theorem 4.6, we describe the binary tree $T(\sigma)$ associated to a 132-avoiding permutation σ , and we then describe the difference in the structure of $T(\tau)$ and $T(\mu)$ where $\mu = \tau^j$ for some j .

The set of all 132-avoiding permutations of length n is in bijection with the set of all binary trees with n vertices, denoted \mathcal{T}_n . This is a well-known result, and it is described in detail in [6]. We will briefly

describe this bijection. For any tree $T \in \mathcal{T}_n$, we label the vertices as follows. We visit each of the vertices of the tree in pre-order (root, left subtree, right subtree), labelling the i th vertex visited by $n+1-i$. Given T with such a labelling, we recover its corresponding permutation $\sigma = \sigma_1 \dots \sigma_n \in S_n(132)$ by visiting the vertices in in-order (left subtree, root, right subtree), letting the i th vertex visited be the value of σ_i . Following the notation of [6], for any $\sigma \in S_n(132)$ we denote its associated binary tree by $T(\sigma)$. We will also assume that the trees come with the pre-order labeling described. Rudolph defines the *spines* of a binary tree T to be connected components of T when all edges connecting left children to their parents are deleted. She also defines the *spine structure* of T to be the sequence $\langle a_1, \dots, a_s \rangle$, where the a_i are the number of vertices in each of the spines in T listed in descending order. We also denote the spine structure of a tree T by $S(T)$, and call the numbers a_i the *parts* of $S(T)$. To make discussions easier, we also define the *spine structure* of a 132-avoiding permutation τ to be the spine structure of the binary tree $T(\tau)$. Define the relation \leq_R called the *refinement order* on the set of all spine structures whose parts sum to n as follows. If $\langle a_1, \dots, a_s \rangle$ and $\langle b_1, \dots, b_t \rangle$ are two spine structures such that $\sum_{i=1}^s a_i = \sum_{i=1}^t b_i = n$, then $\langle a_1, \dots, a_s \rangle \geq_R \langle b_1, \dots, b_t \rangle$ (or equivalently $\langle b_1, \dots, b_t \rangle \leq_R \langle a_1, \dots, a_s \rangle$) if $\langle a_1, \dots, a_s \rangle$ can be obtained from $\langle b_1, \dots, b_t \rangle$ by merging subsets of its parts. For example $\langle 5, 4, 3 \rangle \geq_R \langle 3, 3, 2, 1, 1 \rangle$ since it can be obtained by merging the subset of parts $\{3, 2\}$ and the subset of parts $\{2, 1, 1\}$.

Suppose G is a graph with vertex set S . An *induced subgraph* H of G is a graph with vertex set a subset of S , such that two vertices are adjacent in H if and only if they are adjacent in G . A *subtree* H of a binary tree graph G is an induced subgraph that is itself a binary tree graph, in which the root of H is the closest vertex of H to the root of G .

The following two propositions describe the child/parent relation between vertices in $T(\sigma)$ for a permutation σ . They are used to understand the proof of Proposition 4.3, which describes how $T(\sigma^{\sigma^j})$ is obtained from $T(\sigma)$ when σ^{σ^j} is defined.

Proposition 4.1. *Suppose $\sigma = \sigma_1 \dots \sigma_n \in S_n(132)$. For any index $\alpha \in [n]$ such that $\sigma_\alpha \in [n-1]$, let σ_β be the least integer such that:*

- $\sigma_\beta > \sigma_\alpha$,
- if $\beta < \alpha$, then $\sigma_{\beta+1}, \dots, \sigma_{\alpha-1}$ (this set is empty if $\beta = \alpha - 1$) are all less than σ_α ,
- if $\beta > \alpha$, then $\sigma_{\alpha+1}, \dots, \sigma_{\beta-1}$ (this set is empty if $\beta = \alpha + 1$) are all less than σ_α .

Then σ_β is the parent vertex of σ_α in $T(\sigma)$.

Proof: Suppose that $\sigma_m = n$. Since $\sigma \in S_n(132)$ the words $\sigma_1 \dots \sigma_{m-1}$ and $\sigma_{m+1} \dots \sigma_n$ are both 132-avoiding. Now $T(\sigma)$ has root n , and the left child of n is the root of the subtree $T(\sigma_1 \dots \sigma_{m-1})$, and the right child of n is the root of the subtree $T(\sigma_{m+1} \dots \sigma_n)$. We assume by way of induction, that the proposition is true for all 132-avoiding permutations of length less than n . The proposition is clearly true for permutations of length 1. By the inductive hypothesis, the proposition holds for $T(\sigma_1 \dots \sigma_{m-1})$ and $T(\sigma_{m+1} \dots \sigma_n)$. Then, since the root of $T(\sigma_1 \dots \sigma_{m-1})$ is the largest integer in the set $\{\sigma_1, \dots, \sigma_{m-1}\}$, and the root of $T(\sigma_{m+1} \dots \sigma_n)$ is the largest integer in the set $\{\sigma_{m+1}, \dots, \sigma_n\}$, the condition of the proposition holds for all vertices in $T(\sigma)$, so that the proposition holds for all n . \square

We may also rephrase this result as a condition for being a child, rather than a parent:

Proposition 4.2. Suppose $\sigma = \sigma_1 \dots \sigma_n \in S_n(132)$. For any index $\alpha \in [n]$ such that $\sigma_\alpha > 1$, let β be an index such that $\sigma_\beta < \sigma_\alpha$, and either:

- $\beta < \alpha$, and σ_β is the greatest integer such that $\{\sigma_{\beta+1}, \dots, \sigma_{\alpha-1}\}$ (this set is empty if $\beta = \alpha - 1$) are all less than σ_β ,
- $\beta > \alpha$, and σ_β is the greatest integer such that $\{\sigma_{\alpha+1}, \dots, \sigma_{\beta-1}\}$ (this set is empty if $\beta = \alpha + 1$) are all less than σ_β .

Then σ_β is a child vertex of σ_α in $T(\sigma)$.

Suppose σ is a permutation in $S_n(132)$ such that σ^{σ_j} is defined for some j . Using Propositions 4.1 and 4.2, we can deduce the following about the construction of $T(\sigma)$:

- The vertex σ_i is the left child of σ_j .
- The vertex σ_i has no left child.
- The subtree of T consisting of the right child of σ_i and its descendants is the tree $T(\sigma_{i+1} \dots \sigma_{j-1})$.
- Suppose there is a largest integer m such that all elements in the set $\{\sigma_{j+1}, \dots, \sigma_m\}$ are all less than σ_j . Then the right child of σ_j is the root of the tree $T(\sigma_{j+1} \dots \sigma_m)$. If $j = n$ or $\sigma_{j+1} > \sigma_j$, so that there is no such integer m , then σ_j has no right child (that is, the tree $T(\sigma_{j+1} \dots \sigma_m)$ is empty).

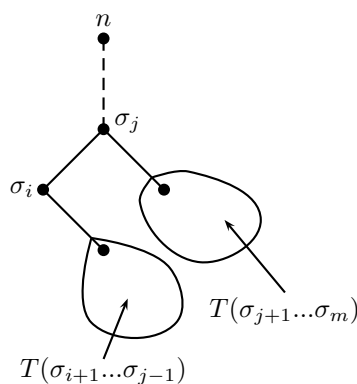

Fig. 2: The tree $T(\sigma)$ for some $\sigma \in S_n(132)$ such that σ^{σ_j} is defined for some j . The vertex σ_j may be the left or right child of its parent vertex.

The following proposition describes how we may alter $T(\sigma)$ to obtain $T(\phi)$ where $\phi = \sigma^{\sigma_j}$ for some j . Figures 3, 4 and 5 give an example of this process.

Proposition 4.3. Suppose that $\phi = \sigma^{\sigma_j}$ is defined for some j . Suppose that m is the largest integer such that $\sigma_{j+1}, \dots, \sigma_m$ are all less than σ_j . Then $T(\phi)$ is obtained from $T(\sigma)$ by the following steps:

- (1) Remove the subtrees $T(\sigma_{i+1} \dots \sigma_{j-1})$ and $T(\sigma_{j+1} \dots \sigma_m)$ from $T(\sigma)$.
- (2) Remove the vertex σ_i from the remaining tree and reattach it as the right child of σ_j .
- (3) Reattach the tree $T(\sigma_{i+1} \dots \sigma_{j-1})$ so that its root is the right child of σ_i .
- (4) Reattach the tree $T(\sigma_{j+1} \dots \sigma_m)$ so that its root is the right child of the vertex σ_{j-1} (note that σ_{j-1} is the smallest integer in the spine of the tree $T(\sigma_{i+1} \dots \sigma_{j-1})$ that contains its root).

Proof: The reader should refer to Propositions 4.1 and 4.2 throughout every step of this proof. Consider all numbers in the set

$$\{\sigma_1, \sigma_2, \dots, \sigma_n\} - (\{\sigma_i, \sigma_{i+1}, \dots, \sigma_{j-1}\} \cup \{\sigma_{j+1}, \dots, \sigma_m\}).$$

A vertex is a left (respectively right) child of another vertex w in this set in $T(\sigma)$, if and only if it is a left (respectively right) child of w in $T(\phi)$. This confirms that step (1) is correct, i.e., that the subtree on the vertices

$$\{\sigma_1, \sigma_2, \dots, \sigma_n\} - (\{\sigma_i, \sigma_{i+1}, \dots, \sigma_{j-1}\} \cup \{\sigma_{j+1}, \dots, \sigma_m\})$$

is identical in $T(\sigma)$ and $T(\phi)$.

It is clear that σ_i is the right child of σ_j in $T(\phi)$. This confirms that step (2) is correct.

A vertex v in the set $\{\sigma_i, \dots, \sigma_{j-1}\}$ is the left (respectively right) child of another vertex w in this set in $T(\sigma)$, if and only if it is the left (respectively right) child of w in $T(\phi)$. This confirms that step (3) is correct.

A vertex v in the set $\{\sigma_{j+1} \dots \sigma_m\}$ is a left (respectively right) child of another vertex w in this set in $T(\sigma)$, if and only if it is a left (respectively right) vertex of w in $T(\phi)$. Also, the root of $T(\sigma_{j+1} \dots \sigma_m)$ is the right child of σ_{j-1} in $T(\phi)$. This confirms step 4. \square

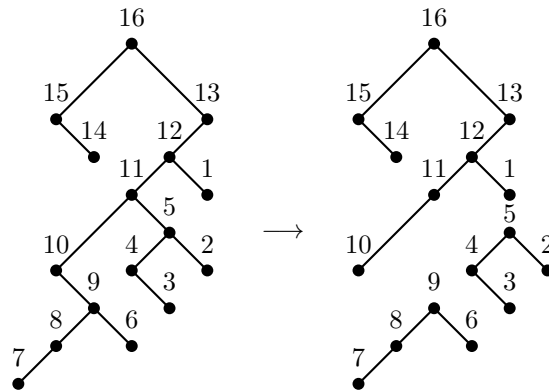

Fig. 3: An example of $T(\sigma)$ for $\sigma = (15, 14, 16, 10, 7, 8, 9, 6, 11, 4, 3, 5, 2, 12, 1, 13)$ in which $\sigma_i = 10$ and $\sigma_j = 11$. We remove the subtrees $T(\sigma_{i+1} \dots \sigma_{j-1}) = T(7896)$ and $T(\sigma_{j+1} \dots \sigma_m) = T(4352)$.

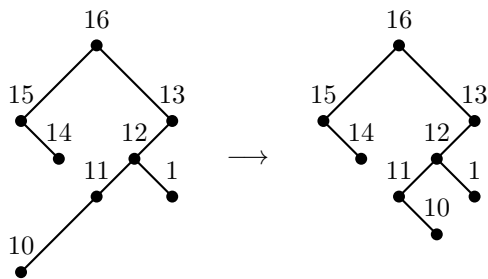

Fig. 4: Reattaching the vertex $\sigma_i = 10$ so that it is the right child of $\sigma_j = 11$.

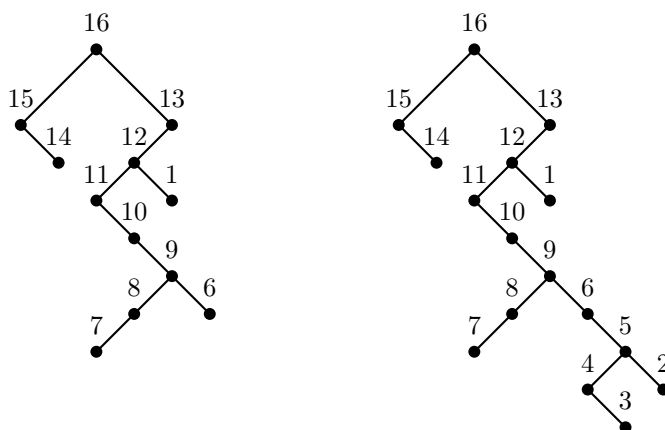

Fig. 5: Left: reattaching the tree $T(\sigma_{i+1} \dots \sigma_{j-1})$. Right: reattaching the tree $T(\sigma_{j+1} \dots \sigma_m)$.

Proposition 4.4. *Suppose that for some j , $\phi = \sigma^{\sigma_j}$, and suppose that $S(T(\sigma)) = \langle a_1, \dots, a_s \rangle$. Then $S(T(\phi))$ is obtained from the spine structure $\langle a_1, \dots, a_s \rangle$ by merging two parts. That is, there exist indices l, m , such that the parts in $S(T(\phi))$ are $\{a_1, \dots, a_s\} - \{a_l, a_m\} \cup \{a_l + a_m\}$.*

Proof: By Proposition 4.3, the spine structure of $T(\phi)$ is obtained from the spine structure of $T(\sigma)$ by merging the spine of $T(\sigma)$ that contains σ_i and the spine of $T(\sigma)$ that contains σ_j . \square

The following definition appears in [6]. A *left-justified* binary tree is a binary tree in which every vertex that is a right child of its parent does not have a left child.

Proposition 4.5. *Suppose that $T_1, T_2 \in \mathcal{T}_n$ and the spine structure of T_2 is obtained from the spine structure of T_1 by merging two parts. Then there exists $\sigma \in S_n(132)$ such that $\phi = \sigma^{\sigma_j}$ is defined for some j , and such that $T(\sigma)$ has the same spine structure as T_1 , and $T(\phi)$ has the same spine structure as T_2 .*

Proof: Suppose that $\langle a_1, \dots, a_s \rangle$ is the spine structure of T_1 , and that a_l and a_m are merged to give the

spine structure of T_2 . We will construct a new tree $T \in \mathcal{T}_n$ that is left-justified, with the same spine structure as T_1 . If we label the vertices of any left-justified tree with s parts in pre-order, then the vertices $n-s+1, n-s+2, \dots, n-1, n$ are a path of vertices in this tree, in which each vertex in this sequence is the left child of the following vertex. Let T be such a tree, so that the spine containing vertex $n-s+1$ has a_l vertices, and the spine containing vertex $n-s+2$ has a_m vertices. The order of the remaining spines in T is irrelevant. Then T is equal to $T(\sigma)$ for some $\sigma \in S_n(132)$ such that $\phi = \sigma^{n-s+2}$ is defined, and the tree $T(\phi)$ has the same spine structure as T_2 . \square

Theorem 4.6. *Suppose τ and μ are elements of $S_k(132)$. If the spine structure of $T(\tau)$ is less than or equal to the spine structure of $T(\mu)$ in refinement order, then for all n , $A_n(\tau) \leq A_n(\mu)$.*

Proof: We may assume that the spine structure of $T(\mu)$ is obtained from the spine structure of $T(\tau)$ by merging two parts, since if this implies $A_n(\tau) \leq A_n(\mu)$, then the theorem also holds if $S(T(\mu))$ is obtained from $S(T(\tau))$ by merging any subsets of parts. By Proposition 4.5, there exists $\bar{\tau}$ and j such that $\bar{\tau}^{\bar{\tau}^j}$ is defined, and such that $S(T(\tau)) = S(T(\bar{\tau}))$ and $S(T(\mu)) = S(T(\bar{\tau}^{\bar{\tau}^j}))$. By Theorem 1.1, $A_n(\tau) = A_n(\bar{\tau})$ and $A_n(\mu) = A_n(\bar{\tau}^{\bar{\tau}^j})$. By Theorem 3.5, $A_n(\bar{\tau}) \leq A_n(\bar{\tau}^{\bar{\tau}^j})$, so that $A_n(\tau) \leq A_n(\mu)$. \square

We will now strengthen the result of Theorem 4.6 by showing, in Theorem 4.8, that if $\mu = \tau^{\tau^j}$ for $\mu \in S_k(132)$, and $n > k$, then $A_n(\mu) > A_n(\tau)$. The following proposition on spine structures is used to prove Theorem 4.8.

Proposition 4.7. *Suppose that $\tau \in S_k(132)$ and that for some j , $\mu = \tau^{\tau^j}$ is defined. Then there exists a permutation $\bar{\tau} \in S_k(132)$ such that $\bar{\mu} = \bar{\tau}^{\bar{\tau}^j}$ is defined, $S(T(\tau)) = S(T(\bar{\tau}))$ and $S(T(\mu)) = S(T(\bar{\mu}))$.*

Proof: Suppose the spine of $T(\tau)$ that contains τ_j contains l vertices, and that the spine of $T(\tau)$ that contains $\tau_i = \tau_j - 1$ contains m vertices. Create a binary tree T with the same spine structure as $T(\tau)$ as follows. First, form a left-justified binary tree T_1 with two spines, one of length m and the other of length l , so that the root of the length l spine is the root of T_1 . Form a left-justified binary tree T_2 whose spines consist of the spines of T that do not contain τ_i or τ_j . Form T by adjoining T_1 and T_2 so that the root of T_2 is the left child of the leaf contained in the same spine as τ_i of T_1 . See Figure 6 for an example. \square

Theorem 4.8. *Suppose $\tau \in S_k(132)$ and that for some j , $\mu = \tau^{\tau^j}$ is defined. Then for any integer $n > k$ we have $A_n(\mu) > A_n(\tau)$.*

Proof: By Proposition 4.7, we may assume that $\tau_j = k$. Then it is possible that n occurs as τ_j . In order to understand this proof we need to recall the proof of Theorem 3.5. We will show that the injective map from $\mathcal{O}_n(\tau)$ to $\mathcal{O}_n(\mu)$, defined in the proof of Theorem 3.5, is not onto. This proves the theorem.

Suppose $n > k$. Then there exists some σ in $S_n(132)$ which contains the pattern μ , such that n occurs as $\mu_1 = k$, $\sigma_n = n-1$, and σ_n is not an element in the occurrence of μ . We require that $\sigma_1 = n$ in this case. If such an occurrence of μ is mapped to by an occurrence of τ , then the occurrence of τ is obtained by shifting n so that entries occurring as elements in $M \cup \{\tau_i\}$ (note $\tau_i = \mu_2$) are to its left, and entries occurring as elements in R are to its right. However such a permutation would not be in $S_n(132)$ because $\sigma_s n(n-1)$ forms a 132 pattern, where σ_s occurs as μ_2 . Hence, in this case, $A_n(\mu) > A_n(\tau)$. \square

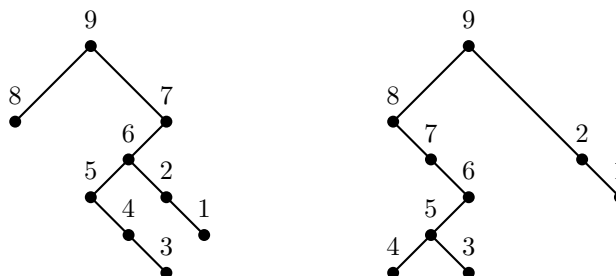

Fig. 6: Let $\tau = 895436217 \in S_9(132)$, and let $\mu = \tau^6$. Then $T(874536921)$ has the same spine structure as $T(\tau)$, and $T(874536921^9)$ has the same spine structure as $T(\mu)$. The tree shown on the left is $T(\tau)$ and the tree shown on the right is $T(874536921)$

5 A counterexample to Conjecture 1.2

In this section, we provide a counterexample to Conjecture 1.2, by showing that for all $n \geq 4$ we have $A_n(3241) \leq A_n(3421)$. This provides a contradiction since $S(T(3241)) = \langle 2, 2 \rangle$ and $S(T(3421)) = \langle 3, 1 \rangle$ are incomparable in refinement order.

Proposition 5.1. *For all $n \geq 4$ we have $A_n(3241) \leq A_n(3421)$. Furthermore, we have equality if and only if $n = 4$.*

Proof: We assume by induction that for all $k \in \{4, 5, \dots, n - 1\}$ we have $A_k(3241) \leq A_k(3421)$. This is true for $k = 4$ since $A_4(3241) = A_4(3421) = 1$. We will now consider possible occurrences of 3241 and 3421 in permutations in $S_n(132)$ for some $n \geq 4$.

For all $n \geq 4$ the following expression holds:

$$A_n(3241) = 2 \sum_{i=4}^{n-1} A_i(3241) |S_{n-1-i}(132)| + \sum_{i=3}^{n-2} A_i(324) A_{n-1-i}(1) + \sum_{i=2}^{n-2} A_i(32) A_{n-1-i}(1).$$

The sum of the first two terms is the number of occurrences of 3241 in which n is not an element in the occurrence. The first term is the number of occurrences in which the element n lies entirely to the right or entirely to the left of elements in the occurrence of 3241, and the second term is the sum of occurrences in which the element n lies between the entry that occurs as 4 and the entry that occurs as 1. The final term is the number of occurrences in which n occurs as 4. Also, for all $n \geq 4$:

$$\begin{aligned}
 A_n(3421) = & 2 \sum_{i=4}^{n-1} A_i(3421) |S_{n-1-i}(132)| + \sum_{i=3}^{n-2} A_i(342) A_{n-1-i}(1) \\
 & + \sum_{i=2}^{n-3} A_i(34) A_{n-1-i}(21) + \sum_{i=1}^{n-3} A_i(3) A_{n-1-i}(21).
 \end{aligned}$$

The sum of the first three terms in the summation is the number of occurrences of 3421 in which n is not an element in the occurrence. The first term is the number of occurrences in which the entry n is entirely to the right or entirely to the left of all elements in the occurrence of 3421. The second term is the number of occurrences of 3421 in which the entry n lies to the right of the entry that occurs as 2 and to the left of the entry that occurs as 1. The third term is the number of occurrences in which the entry n lies between the entry that occurs as 4 and the entry that occurs as 2. The fourth term is the number of occurrences in which n occurs as 4.

By induction, we have that

$$\sum_{i=4}^{n-1} A_i(3241) |S_{n-1-i}(132)| \leq \sum_{i=4}^{n-1} A_i(3421) |S_{n-1-i}(132)|.$$

By Bona’s result in [2], we have that

$$\sum_{i=3}^{n-2} A_i(324) A_{n-1-i}(1) = \sum_{i=3}^{n-2} A_i(342) A_{n-1-i}(1).$$

Also,

$$\sum_{i=2}^{n-2} A_i(32) A_{n-1-i}(1) = \sum_{i=1}^{n-3} A_i(3) A_{n-1-i}(21).$$

Since $\sum_{i=2}^{n-3} A_i(34) A_{n-1-i}(21) > 0$ this implies that $A_n(3241) < A_n(3421)$. □

Corollary 5.2. *There exist permutations τ and μ of the same length k , such that for all $n \geq k$ we have $A_n(\tau) \leq A_n(\mu)$, and the spine structure of $T(\tau)$ is incomparable to the spine structure of $T(\mu)$ in refinement order.*

The counterexample given in Proposition 5.1 leads naturally to Question 5.3, on the popularity of 132-avoiding permutations. For all n , define the partial order \leq_L , called the *lexicographic order*, on the set of partitions of n , as follows. For any partitions $\langle a_1, \dots, a_s \rangle$ and $\langle b_1, \dots, b_t \rangle$, where the parts are listed in descending order, we have $\langle a_1, \dots, a_s \rangle \geq_L \langle b_1, \dots, b_t \rangle$ if there exists $j \in [s]$ such that $a_1 = b_1, a_2 = b_2, \dots, a_{j-1} = b_{j-1}$ and $a_j > b_j$. Note that if $\langle a_1, \dots, a_s \rangle \geq_R \langle b_1, \dots, b_t \rangle$ then it follows that $\langle a_1, \dots, a_s \rangle \geq_L \langle b_1, \dots, b_t \rangle$.

Question 5.3. *Let τ and μ be permutations in $S_k(132)$. Is it true that if $S(T(\tau)) \leq_L S(T(\mu))$, then for all $n \geq k$ we have $A_n(\tau) \leq A_n(\mu)$? If this is true, do we have equality only when $n = k$?*

Proposition 5.1 demonstrates that the first statement in Question 5.3 is true in the case that $k = 4$.

References

- [1] Miklós Bóna, *The Absence of a Pattern and the Occurrences of Another*, Discrete Mathematics and Theoretical Computer Science, **Vol. 14**, 2010, no. 2.
- [2] Miklós Bóna, *Surprising symmetries in Objects Counted by Catalan Numbers*, Electronic Journal of Combinatorics, **Vol. 19**, 2012, no. 1, p. 62.
- [3] Lynn Chua, Krishanu Roy Sankar, *Equipopularity classes of 132-avoiding permutations*, The Electronic Journal of Combinatorics, **Vol. 21**, 2014, no. 1.
- [4] Joshua Cooper, *Combinatorial problems I like*, <http://www.math.sc.edu/~cooper/combprob.html>, accessed 2013.
- [5] Cheyne Homberger, *Expected Patterns in Permutation Classes*, Electronic Journal of Combinatorics, **Vol. 19**, no.3.
- [6] Kate Rudolph, *Pattern Popularity in 132-avoiding Permutations*, The Electronic Journal of Combinatorics, **Vol. 20**, 2013, no. 1, p. 8.

