

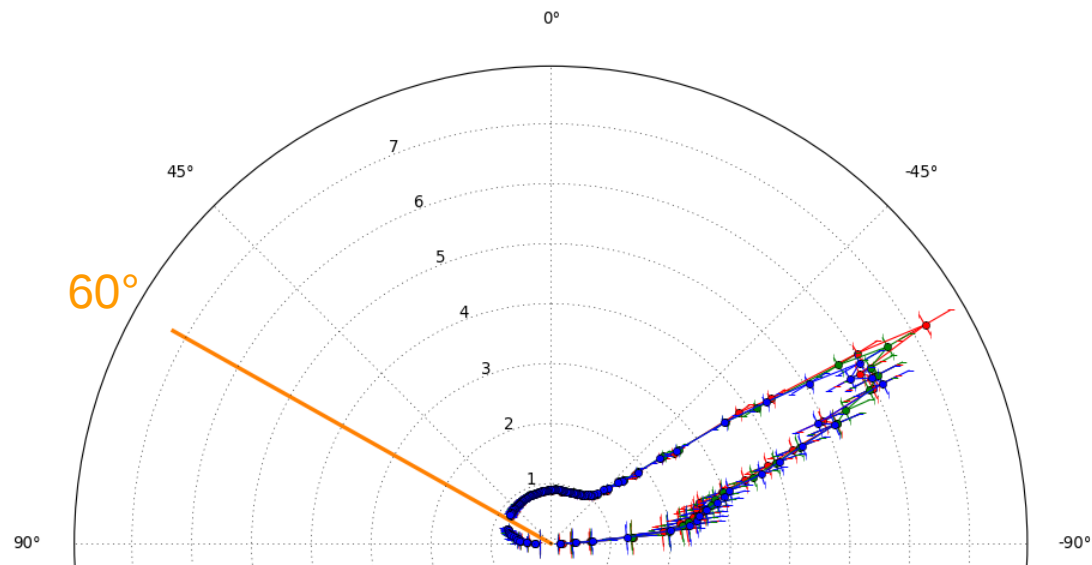

# Isotropic BRDF Measurements with Quantified Uncertainties

R. Hegedus and **A. Lucat** and J. Redon and R. Pacanowski



# Problematic

- How to qualify a BRDF measurement ?

Graphics

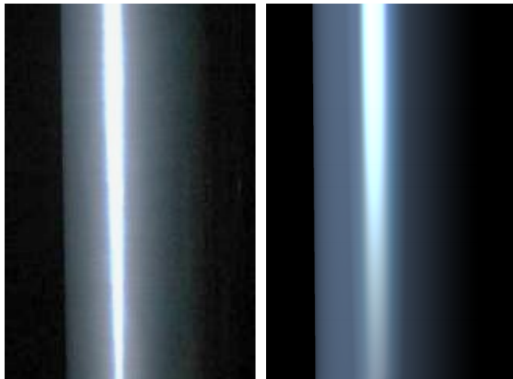

Photo vs. Rendering

**Qualitative error**

# Problematic

- How to qualify a BRDF measurement ?

Graphics

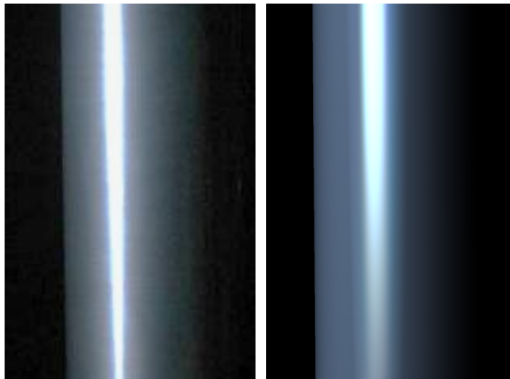

Photo vs. Rendering

**Qualitative error**



**Two setups = two different BRDFs**  
[Obein15]

# Problematic

- How to qualify a BRDF measurement ?

Graphics

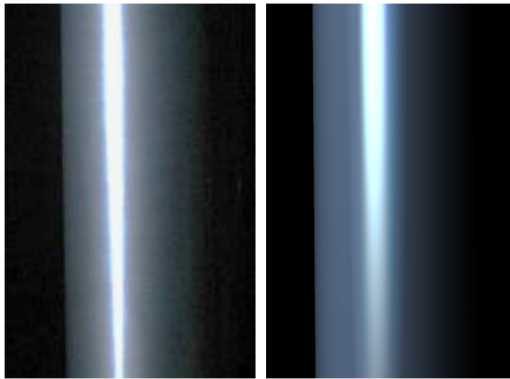
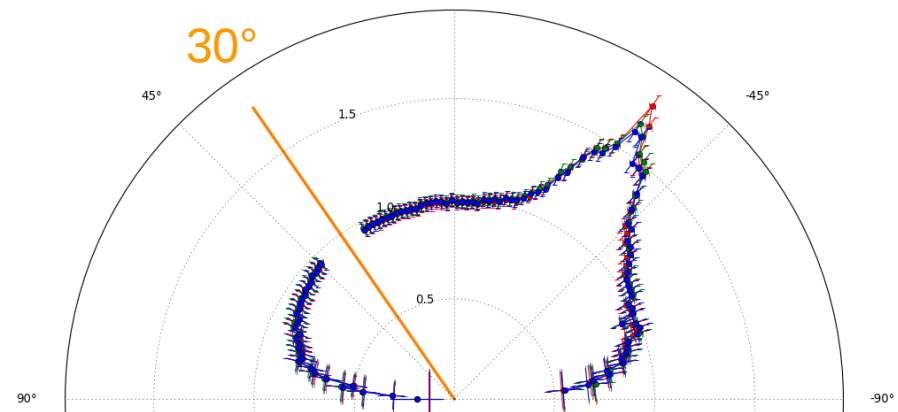

Photo vs. Rendering

**Qualitative error**

Optics



**Quantitative error**



# Problematic

- How to qualify a BRDF measurement ?

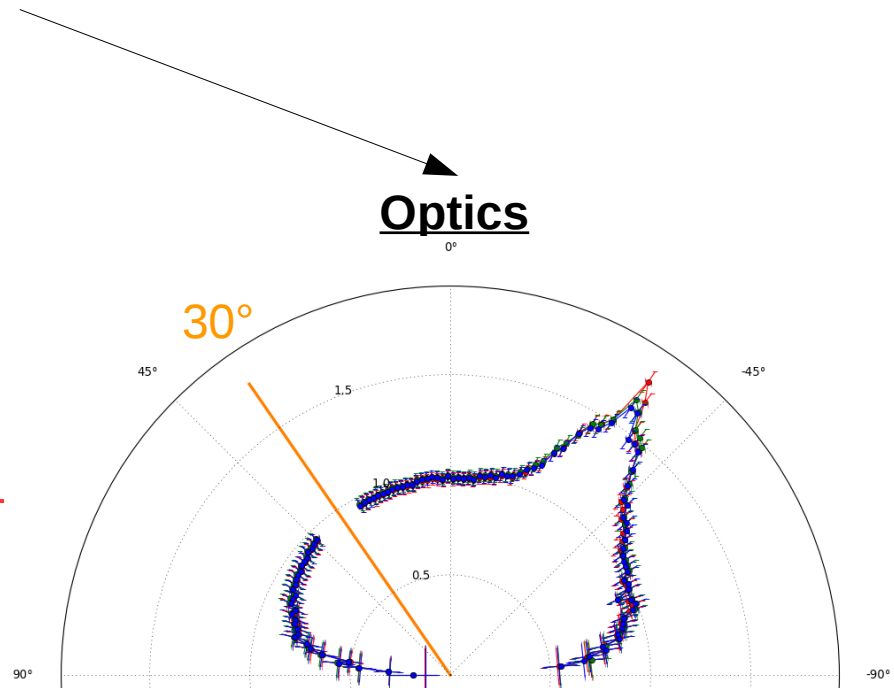

Aim:  
- Create a database with  
quantified uncertainties  
- Material characterization



**Quantitative error**

# The Setup

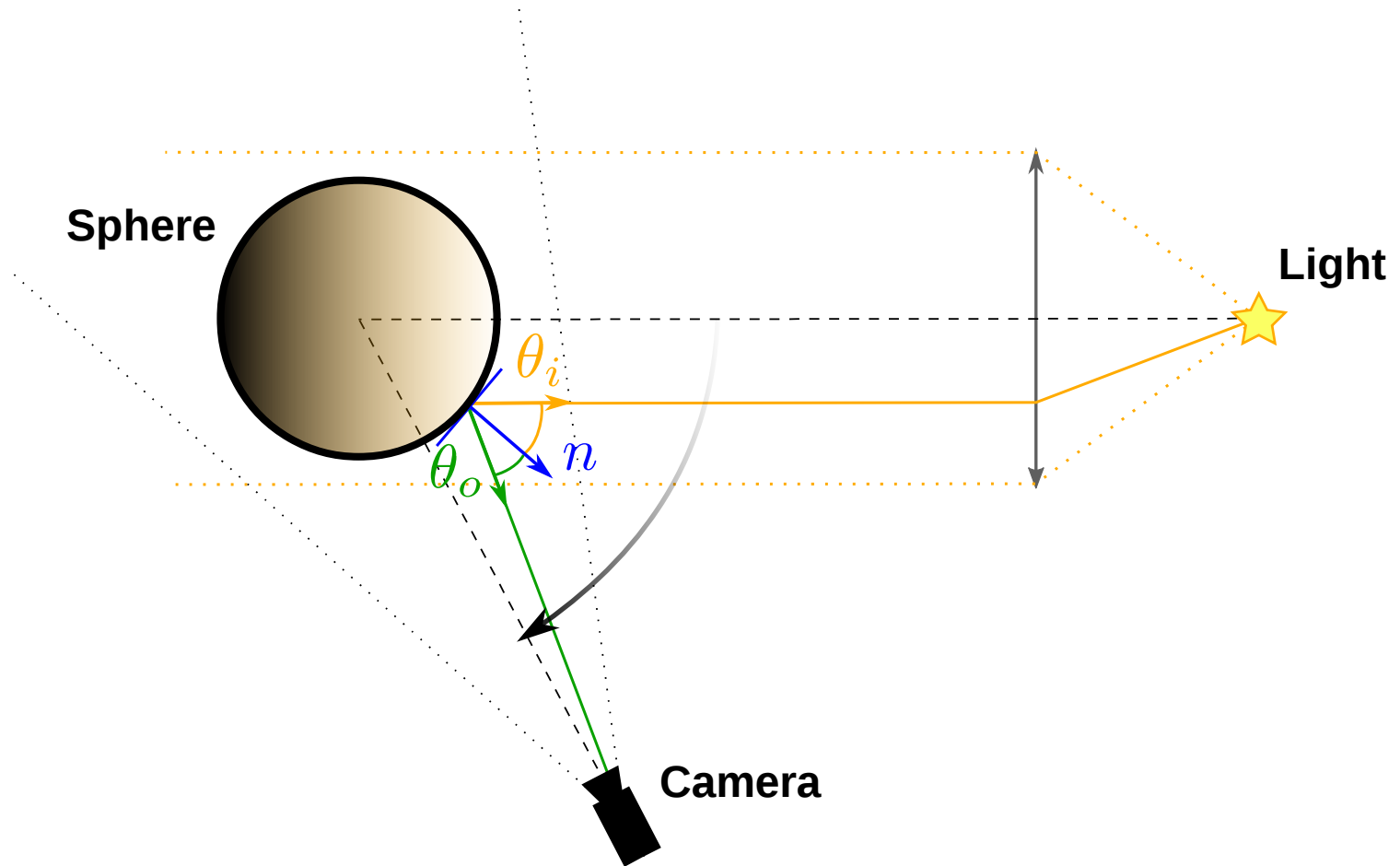

Inspired by [Matusik03] and [Marschner99]

# The Setup

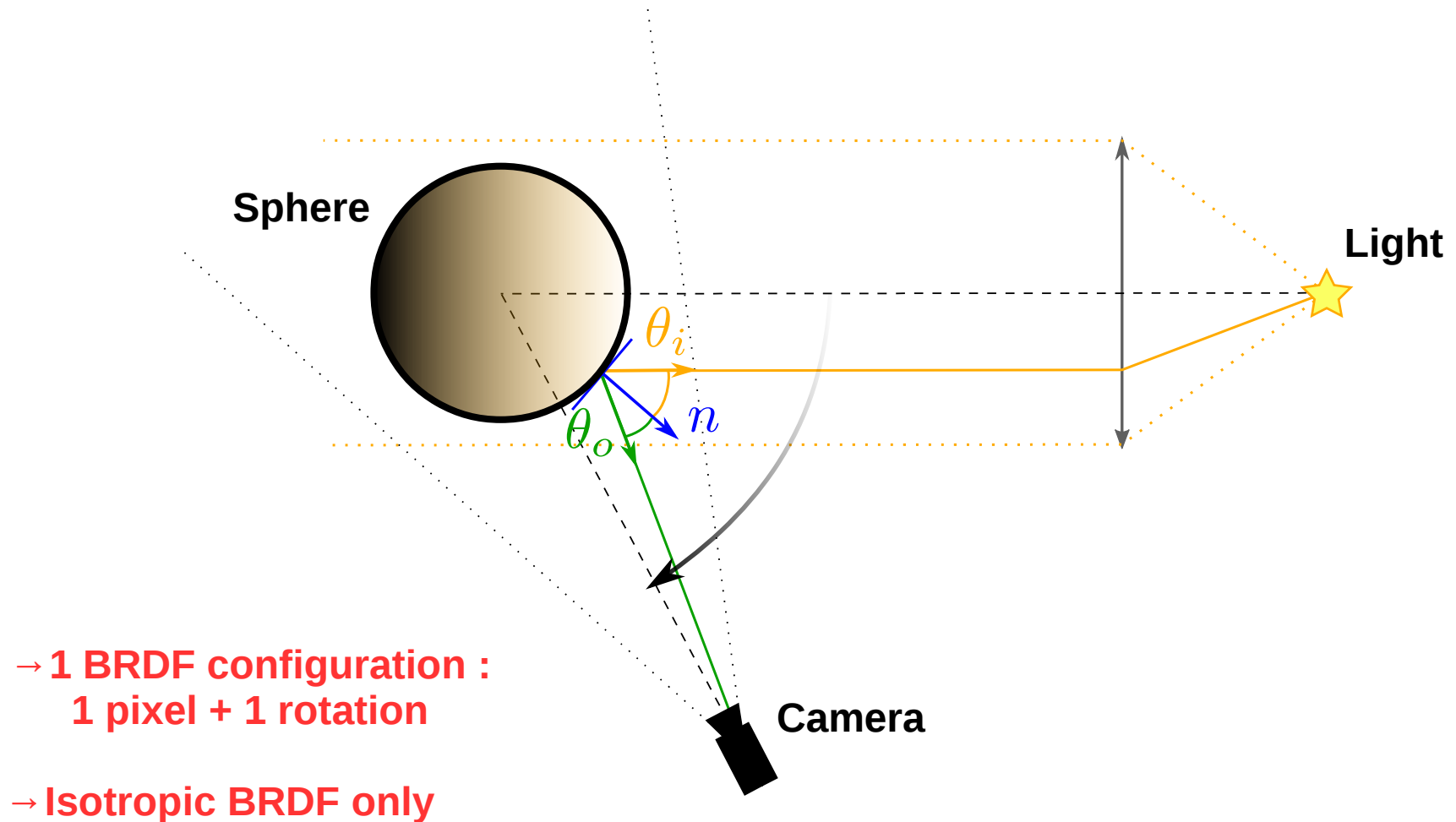

Inspired by [Matusik03] and [Marschner99]

# Measurement Principle

## Physical Elements

Light Source

Rotation Stage

Camera Optics

Sphere

Camera Sensor

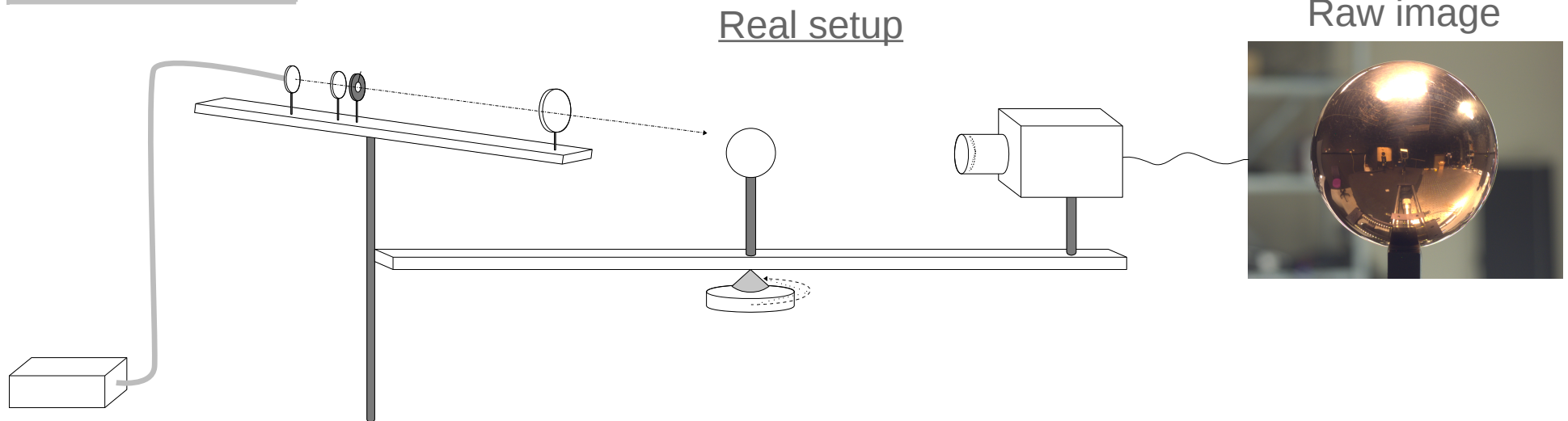

# Measurement Principle

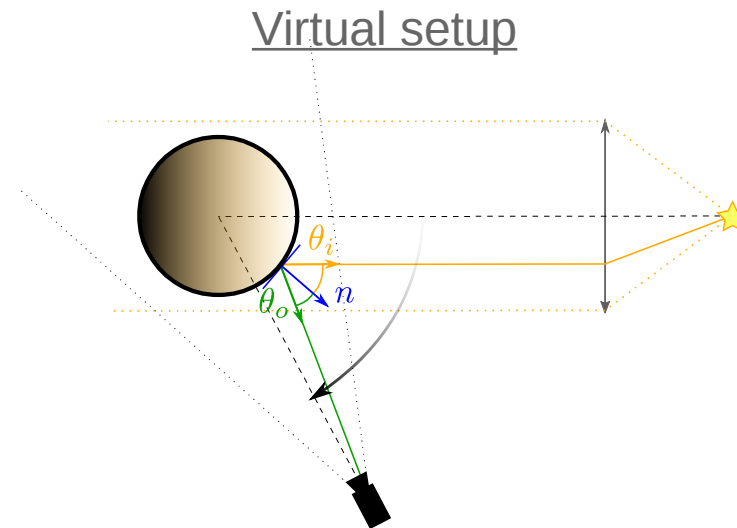
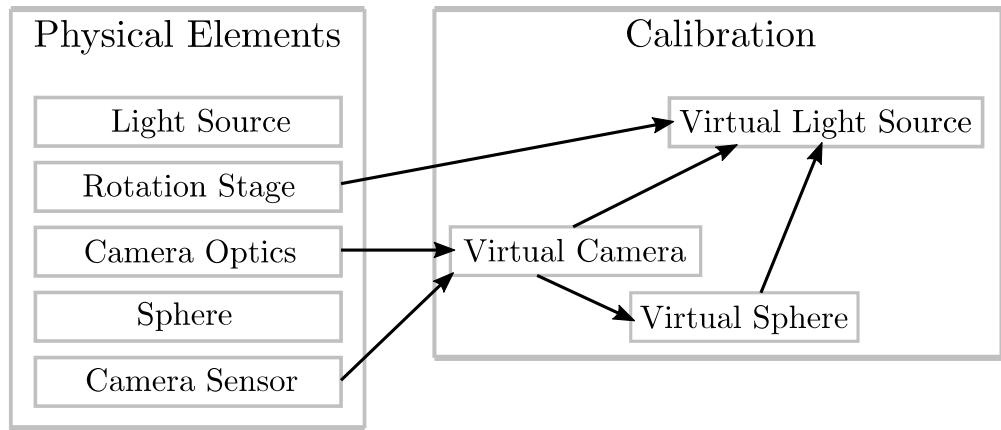

# Measurement Principle

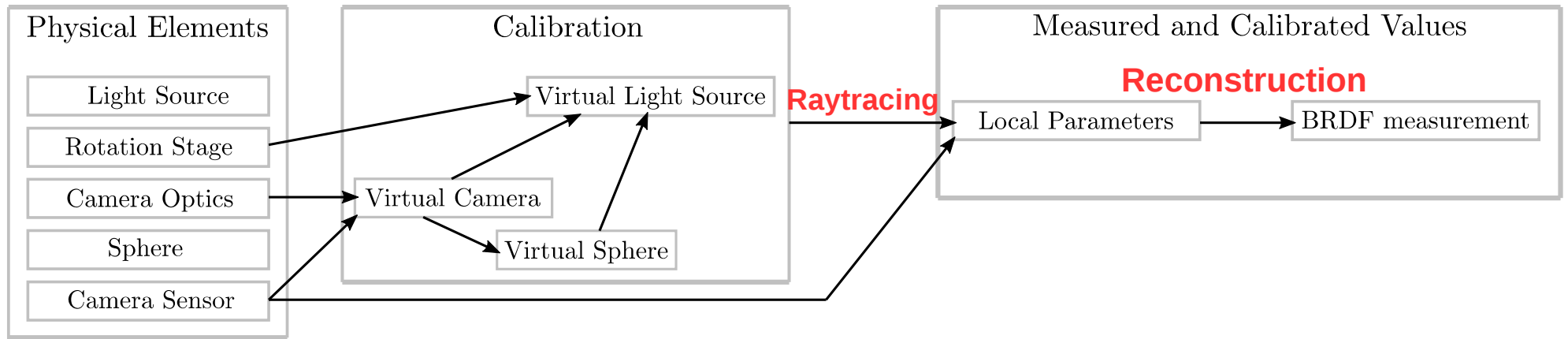

Measured BRDF

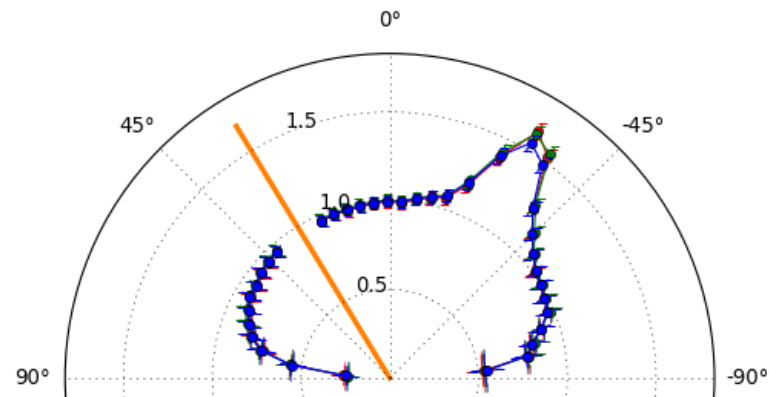

# Uncertainties Propagation

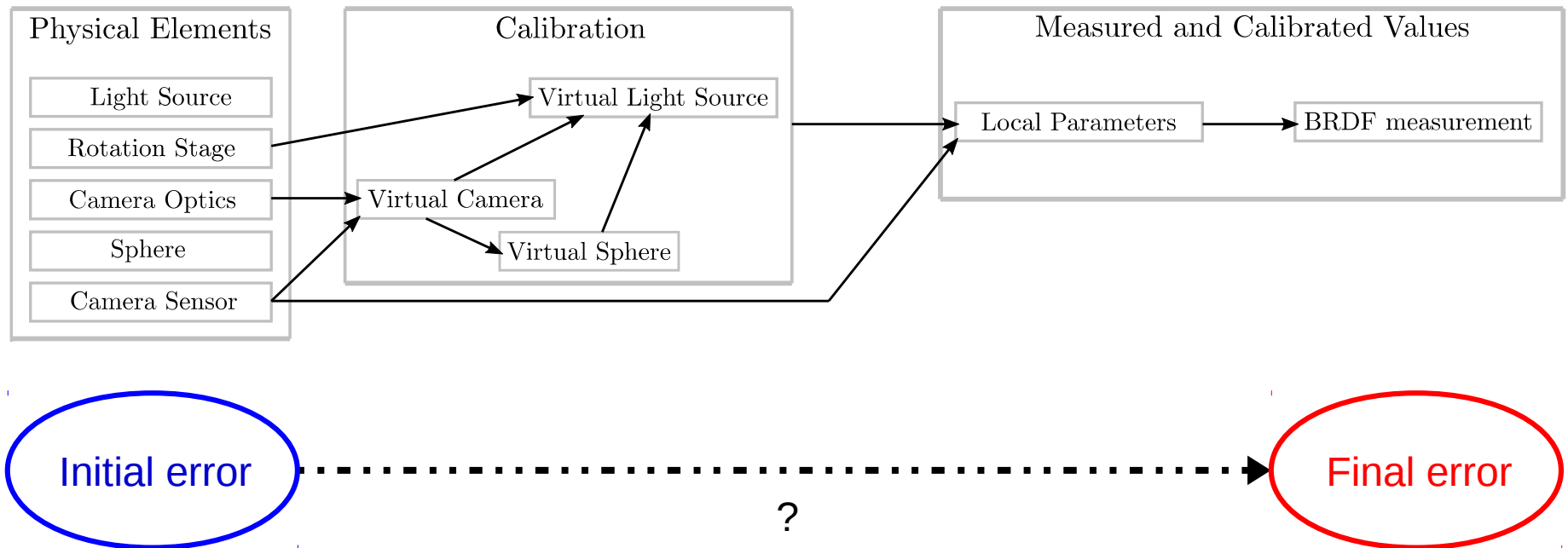

# Uncertainties Propagation

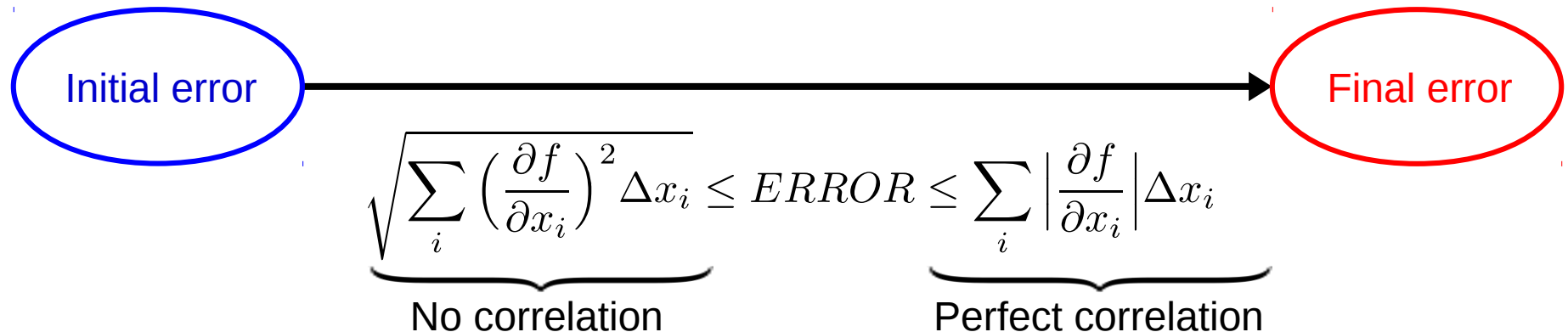
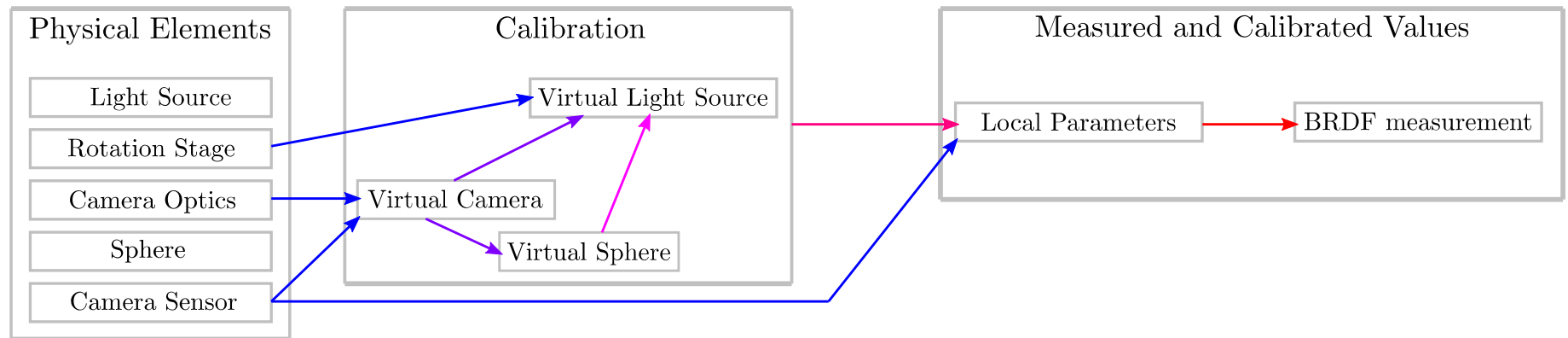



# Uncertainties Propagation

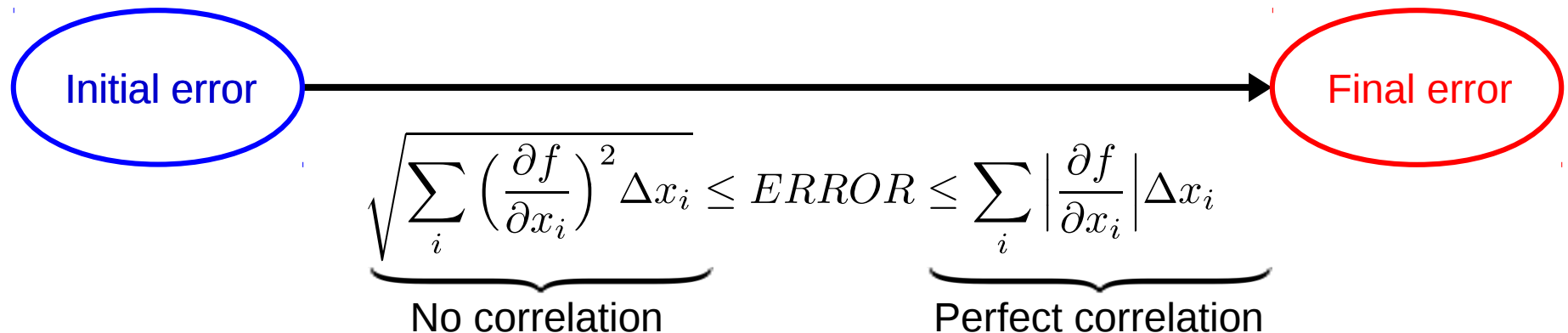
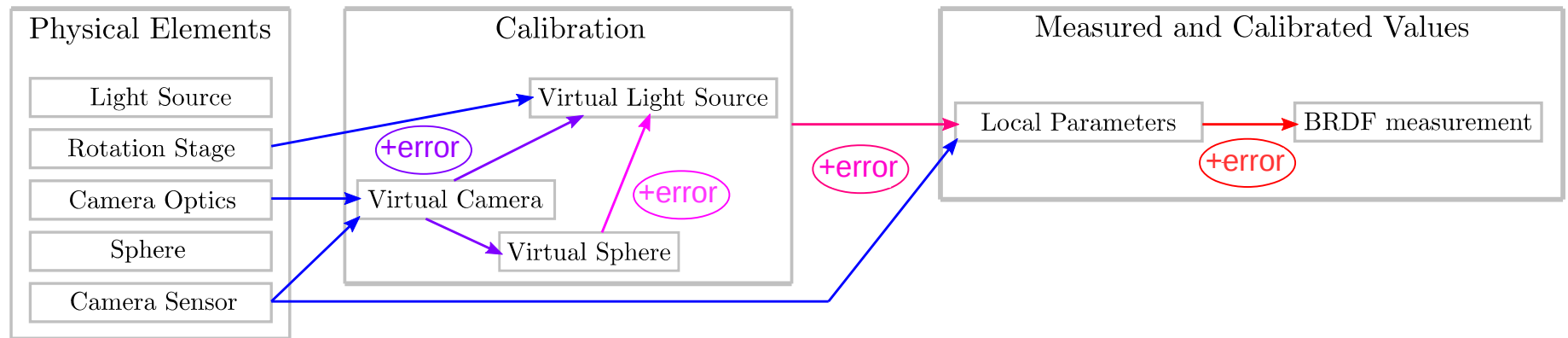

# Uncertainties Propagation

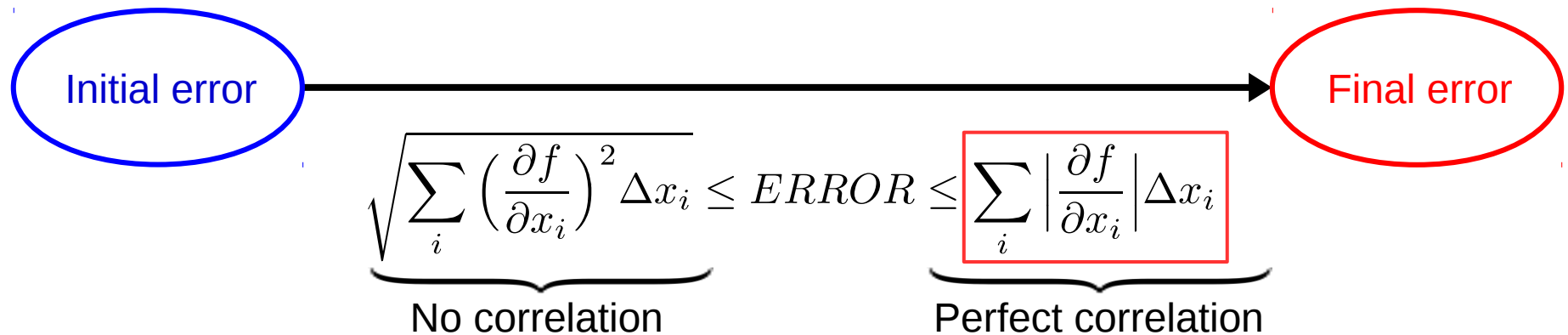
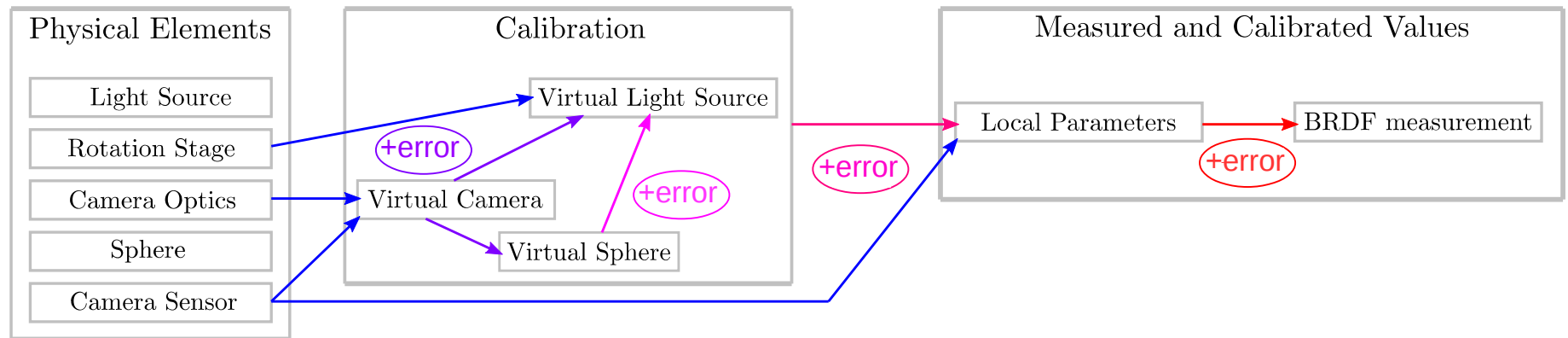

# Results

# Data & Resolution

Specular



Mirror

Copper

Teflon

Spectralon  
**Lambert.  
Standart**

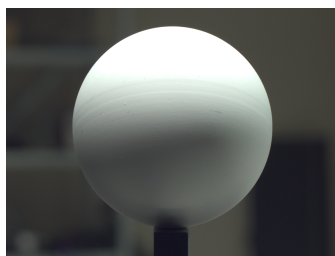
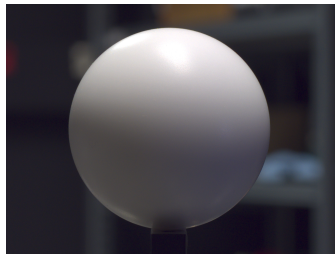
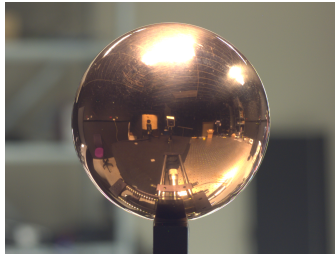

# Data & Resolution

Specular



Mirror

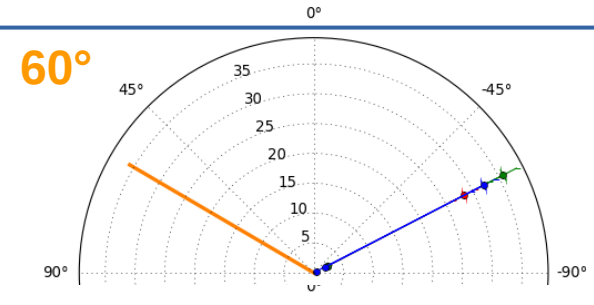
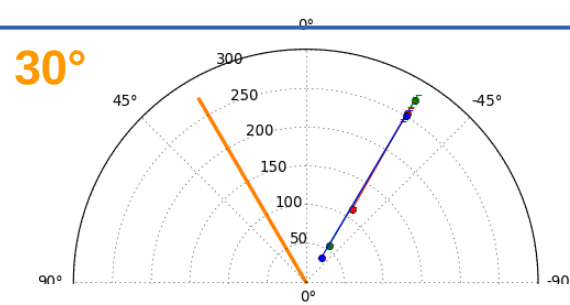
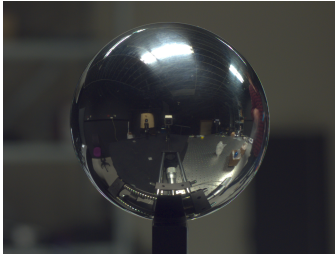

Copper

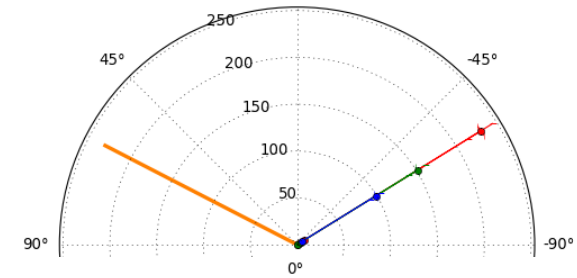
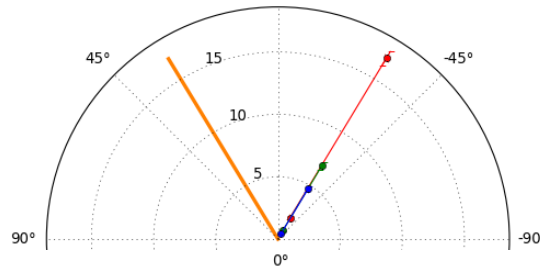
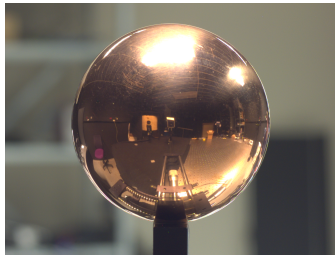

Teflon

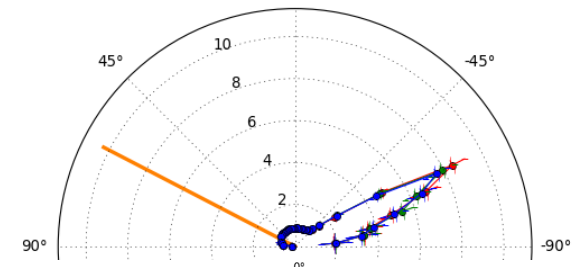
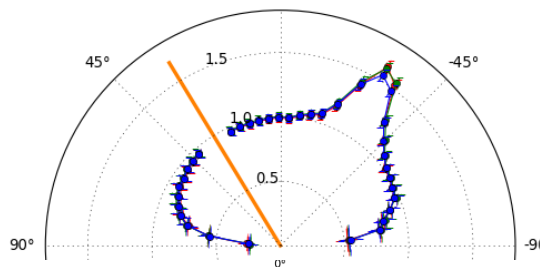
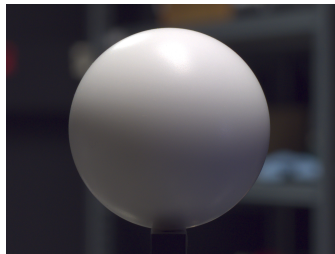

Spectralon  
Lambert.  
Standart

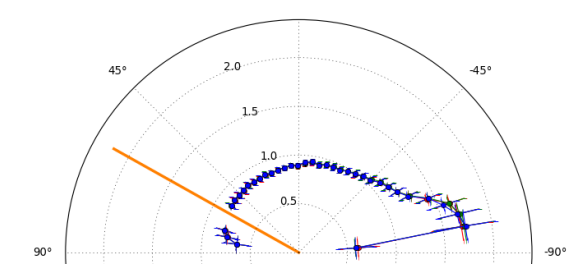
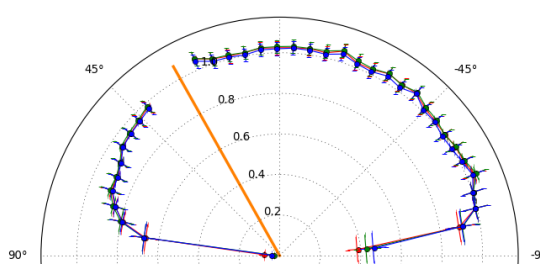
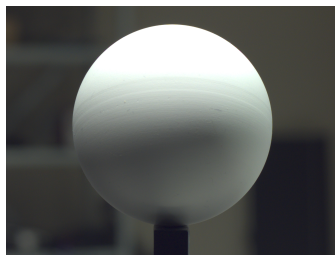

# Data & Resolution

Specular



Mirror



Copper

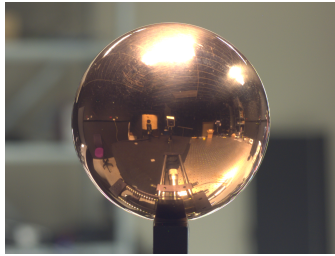

Teflon

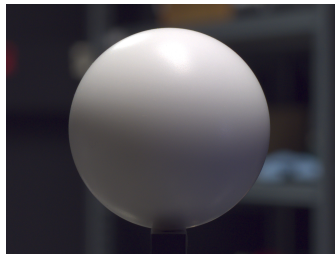

Spectralon  
Lambert.  
Standart

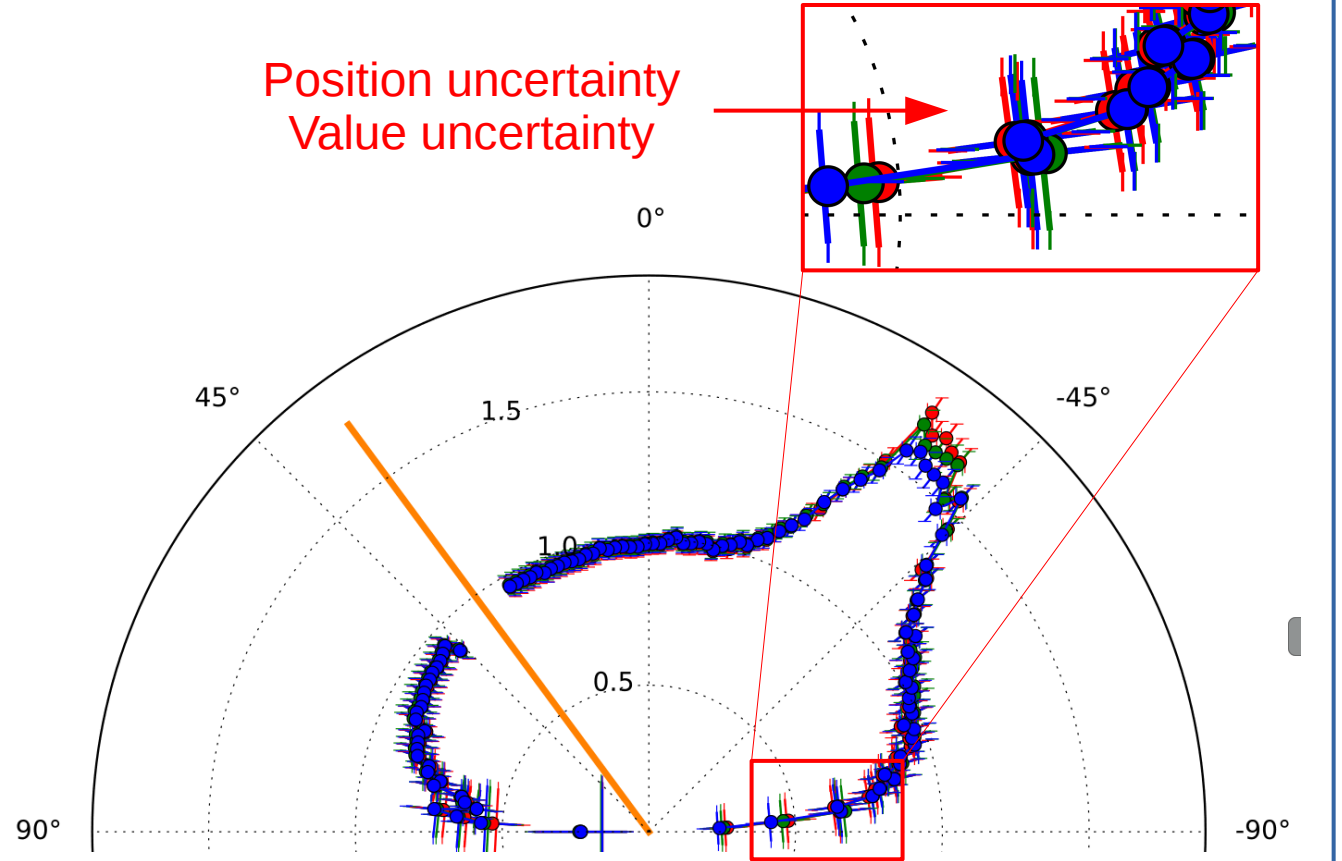
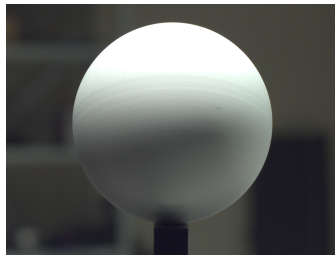

# Data & Resolution

Specular



Mirror



Copper



Teflon



Spectralon

Lambert.  
Standart

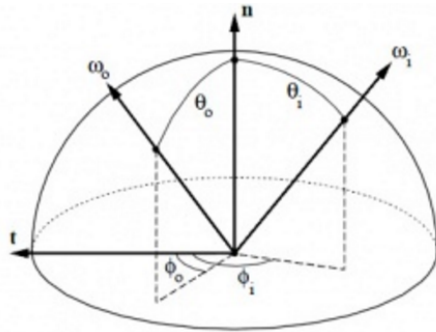

Range  $(\theta_o, \theta_i, \Delta\phi) : (0-85^\circ, 0-90^\circ, 0-360^\circ)$

~100 000 000 points for  $1^\circ$  rotation step

Uncertainty model results :

**Angular resolution :  $0.1^\circ \rightarrow 12^\circ$**   
(normal to grazing view angle)

**Value uncertainty : 3%  $\rightarrow$  100%**

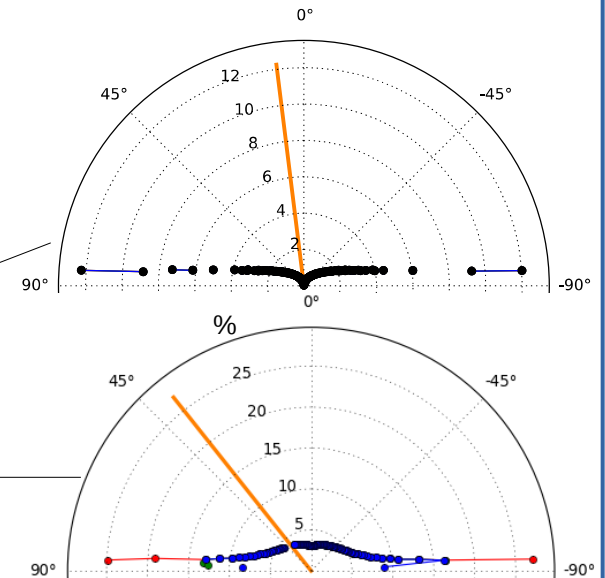

# Uncertainty Analysis

View elevation

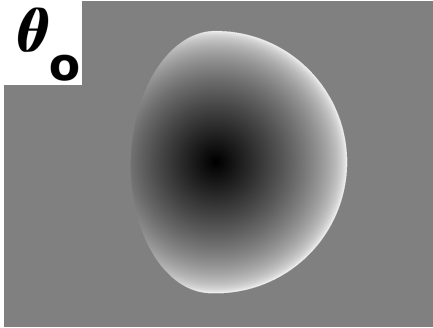

Light elevation

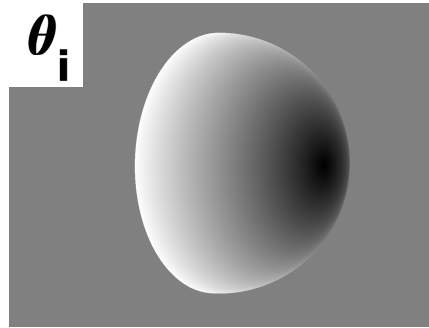

Azimuthal angle

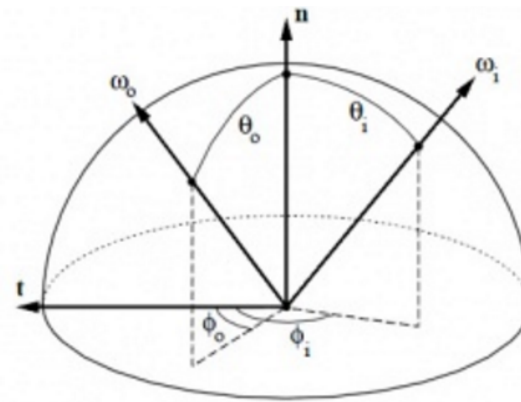
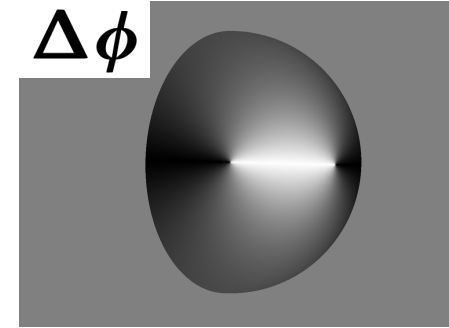



# Uncertainty Analysis

View elevation

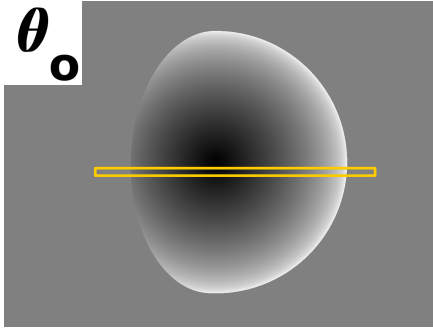

Light elevation

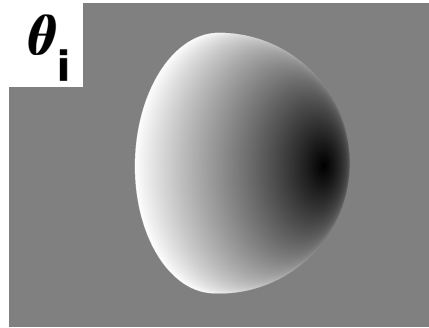

Azimuthal angle

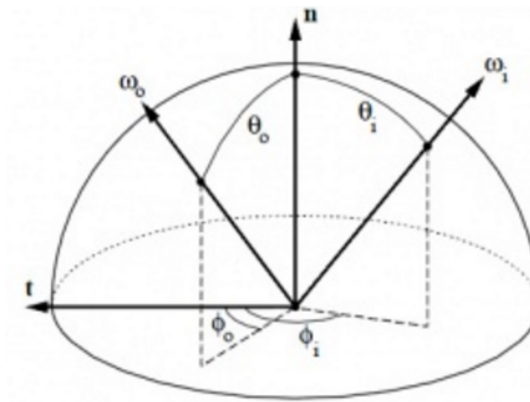
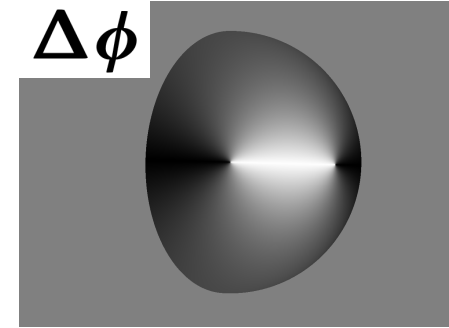

# Uncertainty Analysis

View elevation

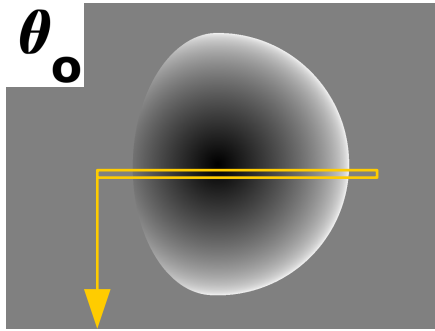

Light elevation

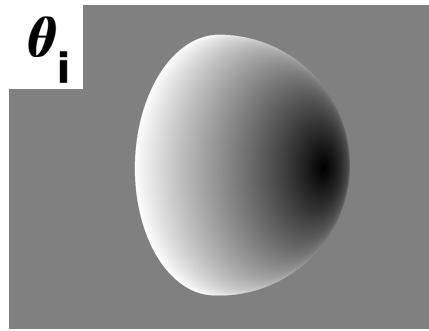

Azimuthal angle

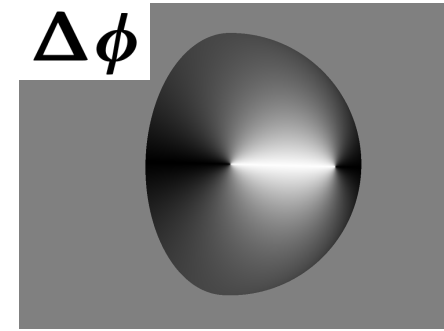

$\theta_o$  Calibration Uncertainty at 52°

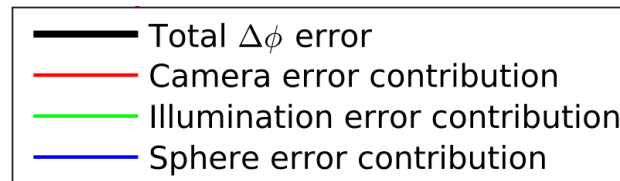
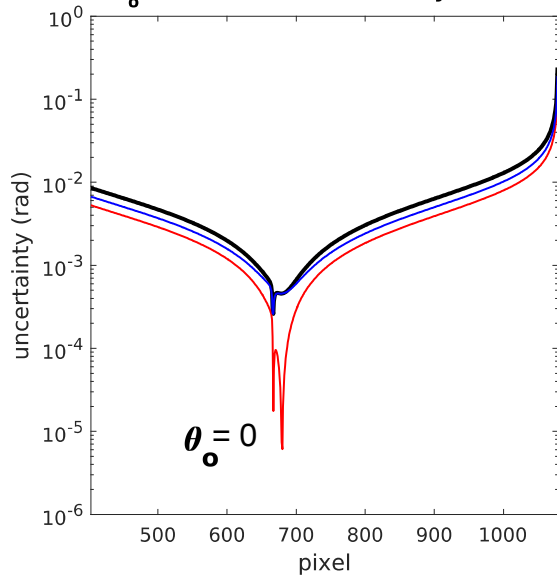

# Uncertainty Analysis

View elevation

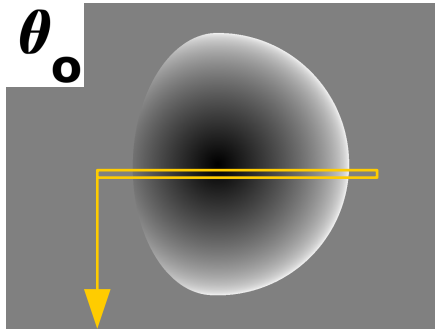

Light elevation

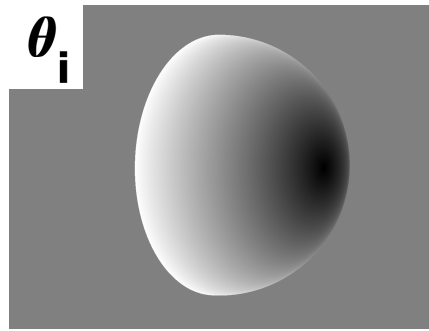

Azimuthal angle

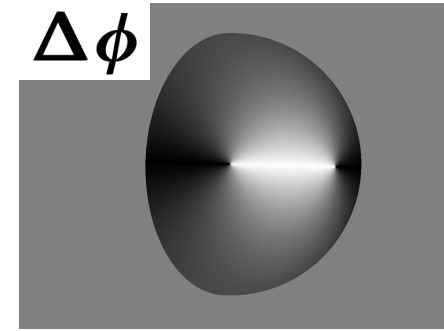

$\theta_o$  Calibration Uncertainty at 52°

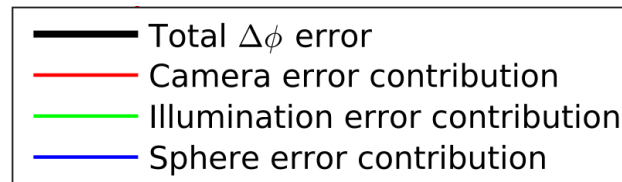
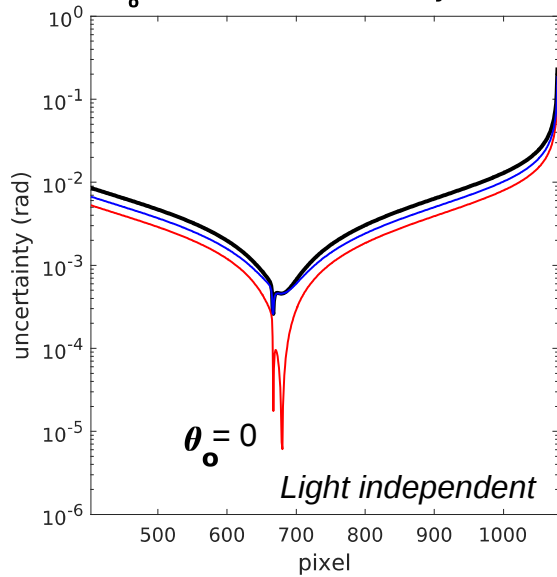

# Uncertainty Analysis

View elevation

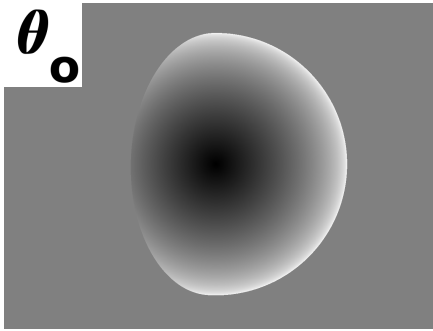

$\theta_o$  Calibration Uncertainty at 52°

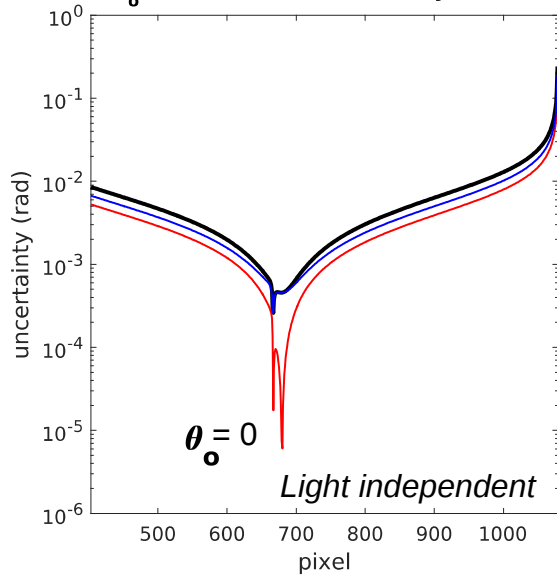

Light elevation

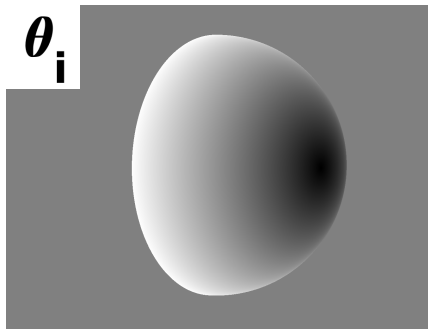

$\theta_i$  Calibration Uncertainty at 52°

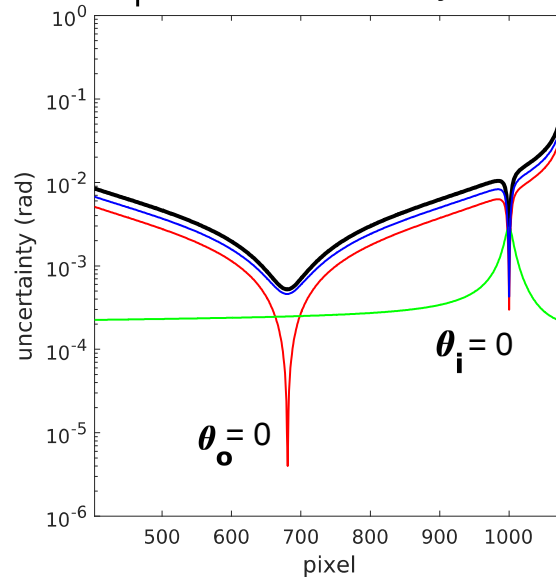

Azimuthal angle

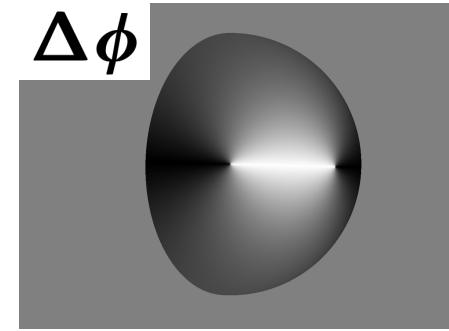

$\Delta\phi$  Calibration Uncertainty at 52°

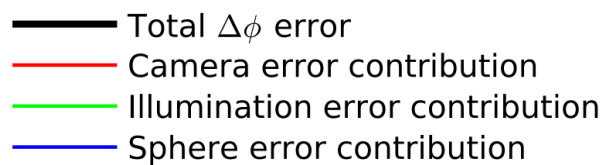
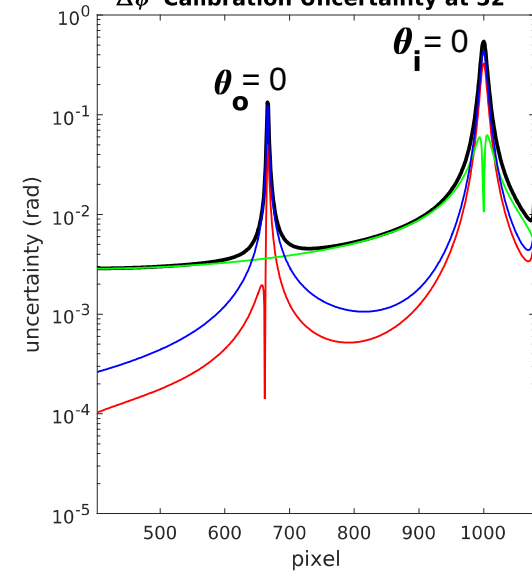

# Uncertainty Analysis

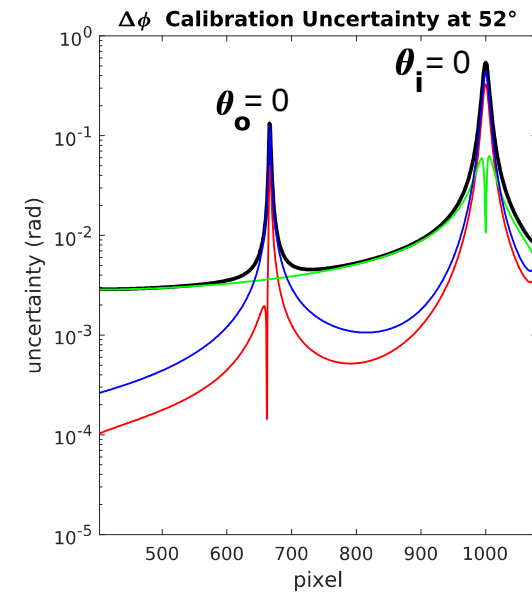
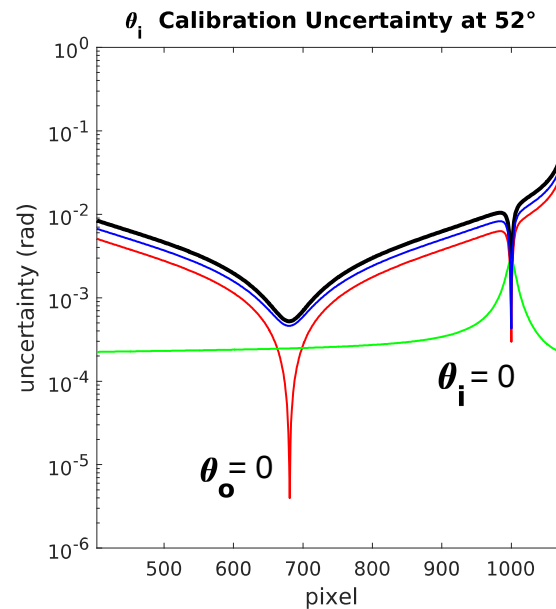
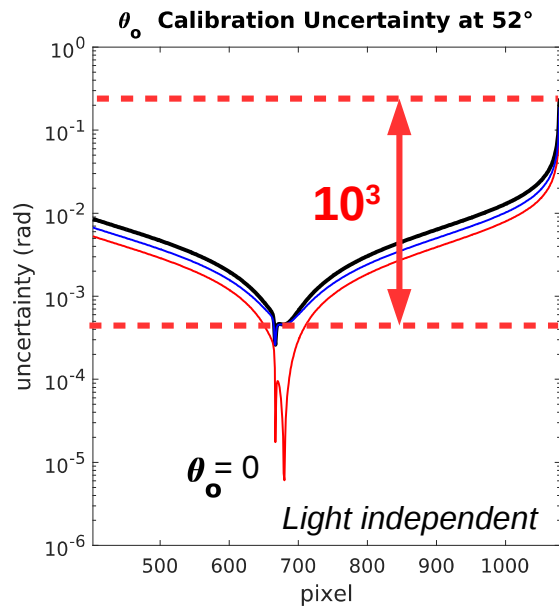

- Unreliable **grazing angle** measurements  
→ 3 orders of magnitude

# Uncertainty Analysis

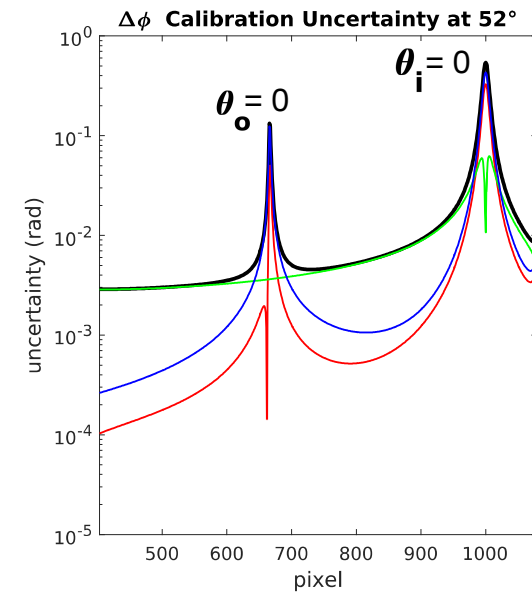
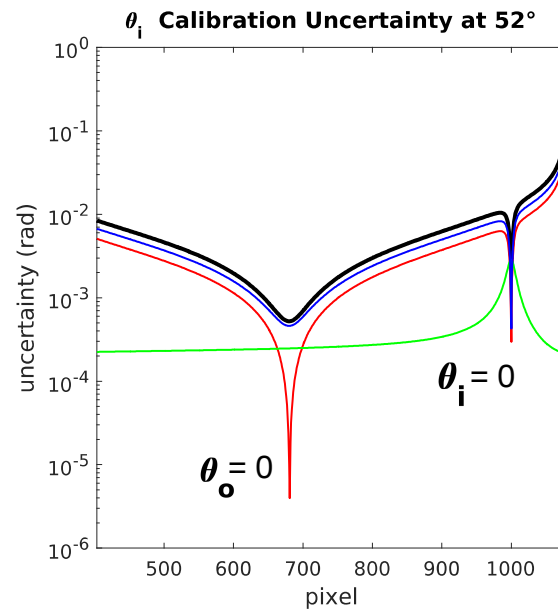
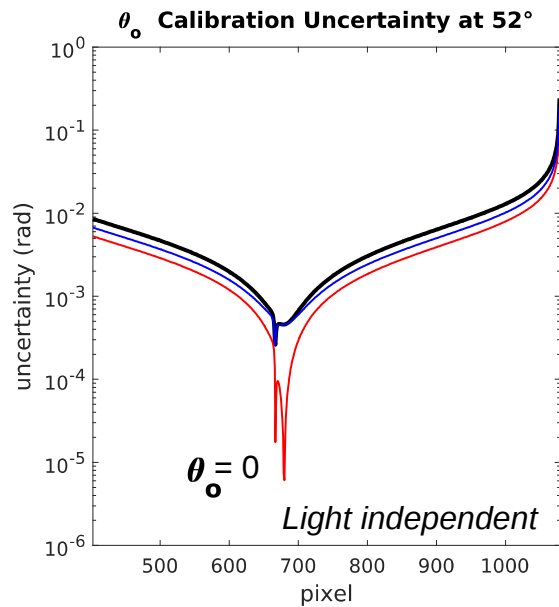

- Unreliable **grazing angle** measurements  
→ 3 orders of magnitude
- Main source of error :  
→ **focal** and **light** uncertainties

# Future Work

# Issues and Future Work

- **Non-uniformities :**
  - White light speckle

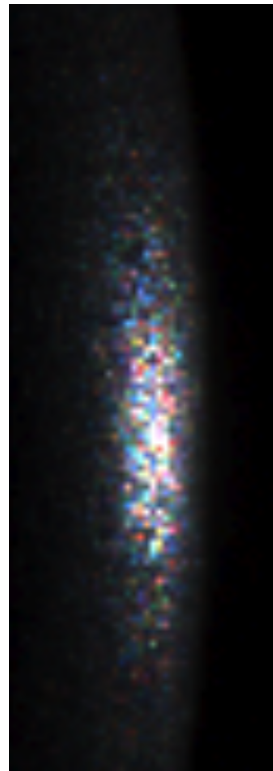



# Issues and Future Work

- **Non-uniformities :**
  - White light speckle

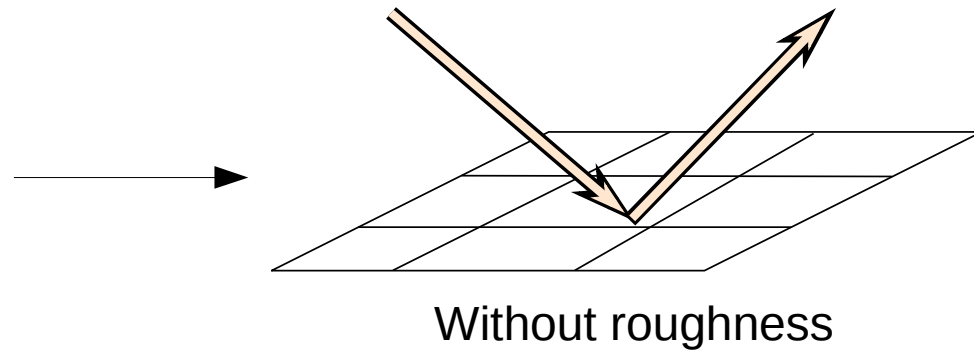
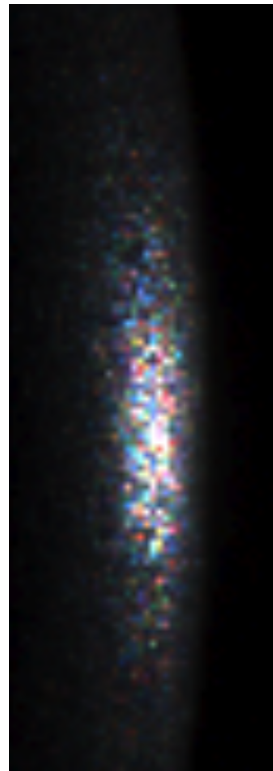

# Issues and Future Work

- **Non-uniformities :**
  - White light speckle

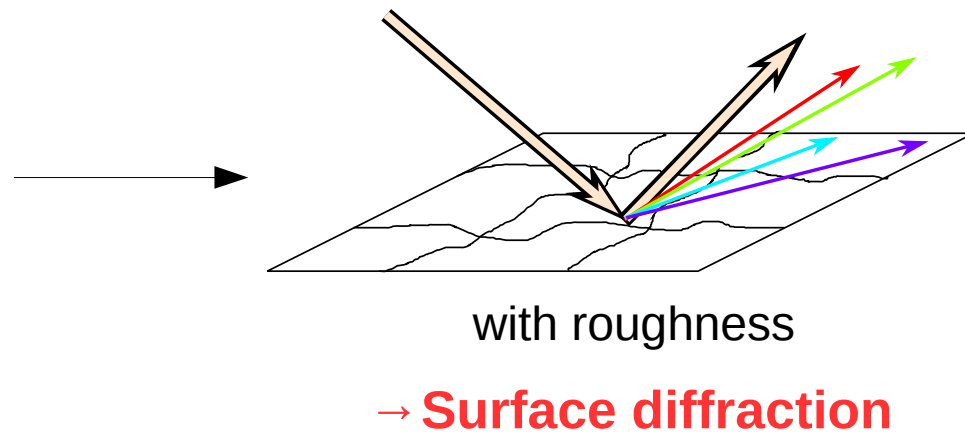
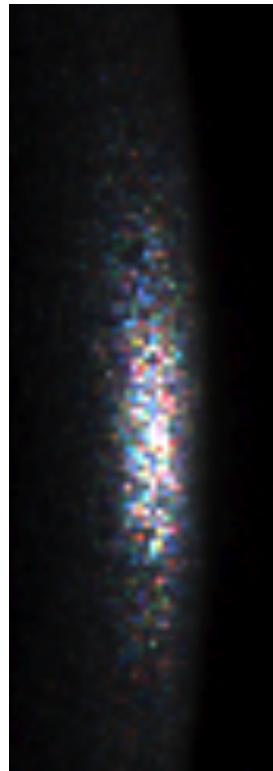

# Issues and Future Work

- **Non-uniformities :**
  - White light speckle
  - Light field

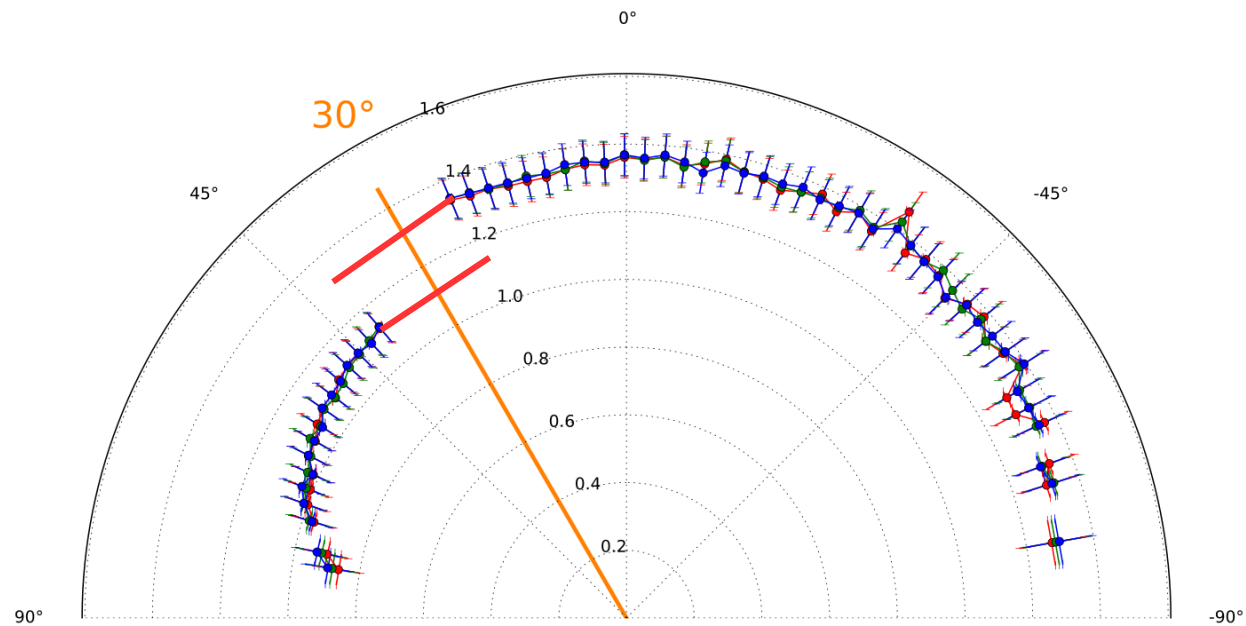

# Issues and Future Work

*Beam intensity*

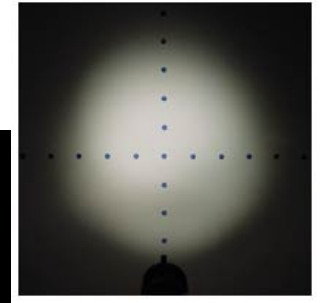

- **Non-uniformities :**
  - White light speckle
  - Light field

Light stains

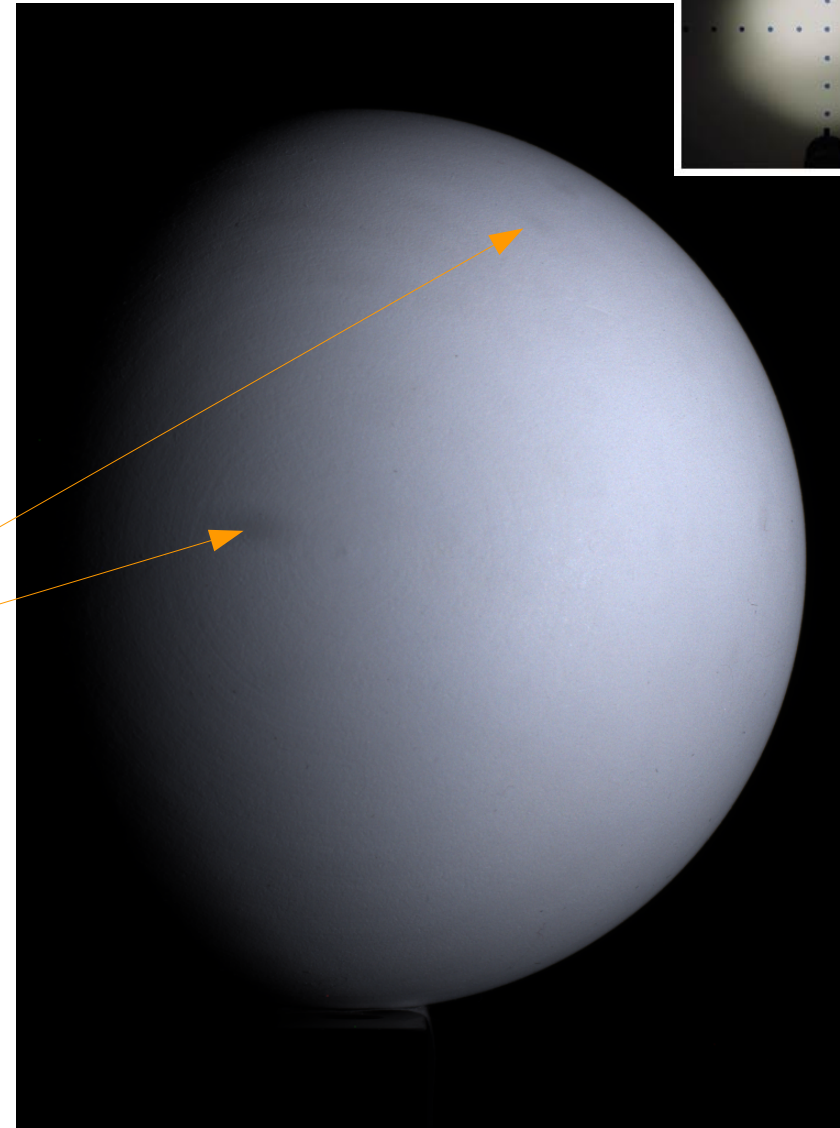

# Issues and Future Work

- **Non-uniformities :**
  - White light speckle
  - Light field
- **Convolution :**
  - Aperture diffraction



→ **Lens diffraction**

# Issues and Future Work

- **Non-uniformities :**
  - White light speckle
  - Light field
- **Convolution :**
  - Aperture diffraction

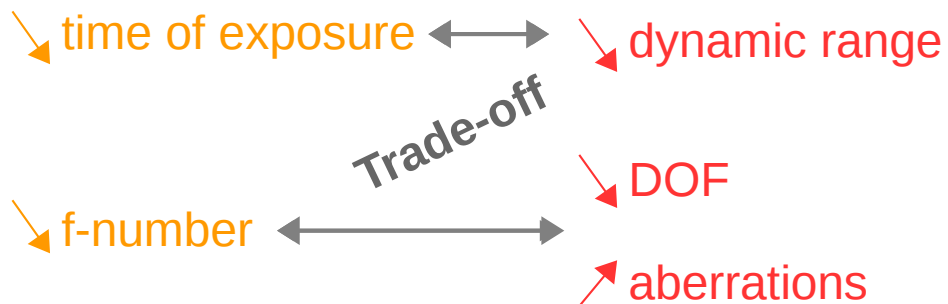

→ **Lens diffraction**

# Conclusion

- BRDF measurement with **quantified uncertainties**
- **Absolute** definition of the setup's **quality** of measurement
- **Possible comparison** between different setups



***Thank you for your attention***

Data will be released on ALTA:  
<http://alta.gforge.inria.fr/data.html>

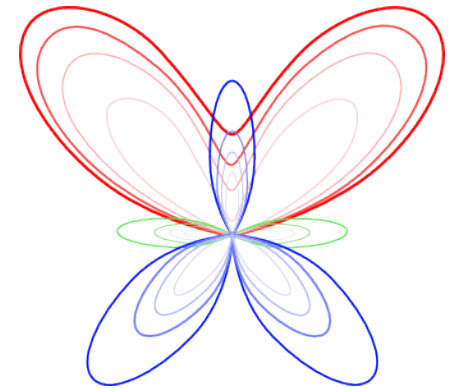



# Reference

- **[Matusik03]**

Matusik W., Pfister H., Brand M., McMillan L. : Efficient isotropic BRDF measurement. In Proc. EGWR '03 (2003), pp. 241-247.

- **[Marschner98]**

Marschner S.R., Westin S.H., Lafortune E.P.F., Torrance K.E., Greenberg D.P.: Image-Based BRDF Measurement Including Human Skin. In Proc. of 10th Eurographics Workshop on Rendering, p.139-152, June 1999.

- **[Obein15]**

Obein G., Audenaert J., Ged G., Leloup F.B. : Metrological issues related to BRDF measurements around the specular direction in the particular case of glossy surfaces. In Proc. SPIE 9398, Measuring, Modeling, and Reproducing Material Appearance 2015, 93980D (March 13, 2015), doi:10.1117/12.2082518.

# Supplemental

- Depth-of-field ?
- Other results ?
- Formulas ?
- Order of errors by parameters (11) ?
- Videos ?