



HAL
open science

Heat transfer 1D modeling for Non Destructive Testing and Structural Health Monitoring for civil engineering structures improved by GPGPU

Antoine Crinière, Jean Dumoulin, Laurent Mevel

► To cite this version:

Antoine Crinière, Jean Dumoulin, Laurent Mevel. Heat transfer 1D modeling for Non Destructive Testing and Structural Health Monitoring for civil engineering structures improved by GPGPU. 8th European Workshop On Structural Health Monitoring (EWSHM 2016), Jul 2016, Bilbao Spain. hal-01332760

HAL Id: hal-01332760

<https://inria.hal.science/hal-01332760>

Submitted on 26 Sep 2016

HAL is a multi-disciplinary open access archive for the deposit and dissemination of scientific research documents, whether they are published or not. The documents may come from teaching and research institutions in France or abroad, or from public or private research centers.

L'archive ouverte pluridisciplinaire **HAL**, est destinée au dépôt et à la diffusion de documents scientifiques de niveau recherche, publiés ou non, émanant des établissements d'enseignement et de recherche français ou étrangers, des laboratoires publics ou privés.

Heat transfer 1D modeling for Non Destructive Testing and Structural Health Monitoring for civil engineering structures improved by GPGPU

by A. Crinière¹, J. Dumoulin^{1,2}, L. Mevel¹

¹ Inria/IFSTTAR, I4S Team, Campus de Beaulieu, 35042 Rennes cedex, France - antoine.crinier@inria.fr

² LUNAM Université, IFSTTAR, COSYS, SII, F-44340 Bouguenais, France

Key words: Smart structures, SHM, Long term thermal monitoring, SHM, GPGPU.

Abstract

Since the past decade, infrared thermography coupled with inverse models based on 1d thermal quadrupoles have shown their usefulness in civil engineering by first showing their ability to assess the quantitative non destructive testing of concrete repaired by bonded CFRP plate over a wide area (i.e. repaired or reinforced concrete beams). On the other hand early implementations of long terms monitoring methods based on such approach have given their first results over a whole bridge deck.

The experimental method, allow us to have the apparent surface temperature field evolution with time for a wide area divided in pixels. Knowing this specificity, the procedure aims to apply an independent model to each pixel in order to retrieve physical properties map. Such treatment can have a high computational cost.

In this paper we propose various improvement of our procedure based on GPGPU paradigm in order to shorten the computational time. This study will detail an experimental procedure able to assess the long term thermal monitoring of a bridge deck over days and to draw properties maps of the inner structure.

1. INTRODUCTION

Among the electromagnetic (EM) methods investigated, infrared thermography using an uncooled infrared camera is a promising technique due to its dissemination potential (according to its low cost on the market). Furthermore, active infrared thermography for the detection of defects has been used for many years now for the non-destructive control of materials such as metals or composites, as described in the literature [1]. Its application to civil engineering materials like cement concrete, a slightly porous and almost homogeneous material, has been also shown. In such a context, infrared thermography, when it is used in a quantitative mode (not in laboratory conditions) and not in a qualitative mode (vision applied to survey), needs to process thermal radiative corrections on the raw data acquired in real time, to take into account the influences of the natural environment's evolution with time. However the camera sensor has to be smart enough to apply calibration laws and radiometric corrections in real time in a varying atmosphere. Past study has permitted the development of information system [2], and various thermal inverse models able to draw properties maps of various materials and structure [3-5]. This paper will present the last optimization of such method thanks to GPGPU computing (General Purpose processing on Graphical Processing Units). The information system and models are presented and the results are discussed

2. INFORMATION SYSTEM

The measurement system implemented on real site is a multisensor one. It uses a fast Ethernet camera FLIR A320 coupled with a VAISALA WXT520 weather station, and a light GPS unit for

positioning and timing. It can be used with other Ethernet infrared cameras (i.e. visible ones) but requires being able to access measured data at raw level. In the present study, it has been made possible thanks to a specific agreement signed with FLIR Company. Figure 1 shows a schematic representation of the interconnection between all measurement systems. The measurement system can be remotely control via WiFi connection. For field application an outdoor WiFi access point was used to improve communication performances. Though the run time measurement platform is running under Linux, the used remote control PC can be run on different operating system (from PC to Mac OS up to android and IOS). The infrared measurement system prototype system is implemented on low cost small computer that integrates a GPU card to allow real time parallel computing. Measurement corrections are carried out inline using the weather station measurements. It takes benefit of the IFSTTAR models compiler that allows one to use its own calibration and measurement correction laws or the ones proposed by infrared camera provider [2]. Compiled models are compliant for GPU computing. The apparent temperature data conversion from raw data matrix and measured environmental conditions is operated for each time step at pixel level using parallel computing. Figure 2 shows a schematic representation of infrared raw data matrix conversion into infrared image of apparent surface temperature using models running on GPU.

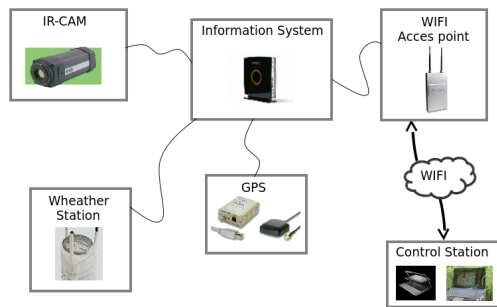

Figure 1: Measurement system used.

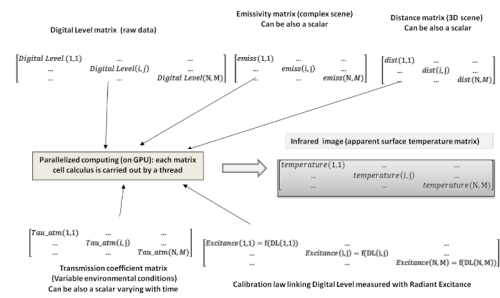

Figure 2: Embedded temperature conversion

In the present study, classical radiative heat balance [6-7] is used to obtain the bridge deck surface temperature, the whole infrared measurement system was operated through a dedicated software called “IrLaW” (Infrared thermography through Lan and WiFi), designed and developed at IFSTTAR [2].

3. EXPERIMENTAL SITE AND SYSTEM DEPLOYMENT

The experiment took place on the ‘Musmeci’ bridge in Potenza (Italy) as part of the ISTIMES FP7 project, figure 3. It is made up of a reinforced concrete box plank, held each 17.30 m by a reinforced concrete continuous vault equivalent to four arches with wheelbases of 17.30 m × 4 =69.20 m and a free span amongst the supports of 58.80 m. The entire bridge consists of four spans of 69.20 m with an overall length of 277 m. The bridge is an example of static load optimization of concrete structures [8]. The whole measurement system was implemented on the ‘Musmeci’ bridge in July 2011. No traffic interruption was required during the mounting of our measurement system.

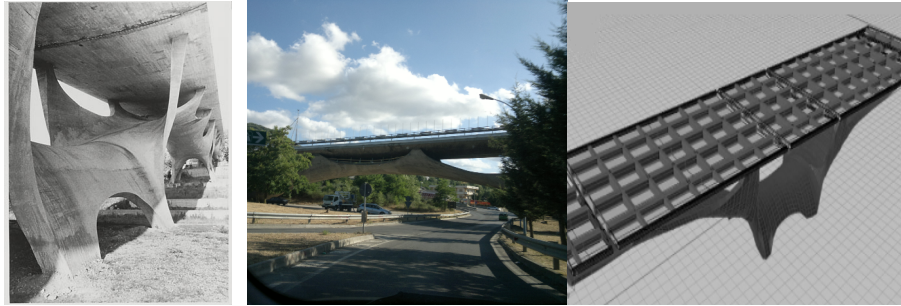

Figure 3: The “Musmeci” bridge and its intern structure

Figure 4 shows the infrared camera implementation on a mast located on the shoulder of the bridge deck. The camera was mounted on top of the mast at an elevation of 6 m from the surface of the bridge deck. The weather station was mounted on the same mast at 1 m under the camera. A GPS antenna was also fixed at the base of the mast and at a same elevation to the bridge deck surface. Figure 4 it shows a picture of the bridge deck with a purple area that matches the field of view of the infrared camera.

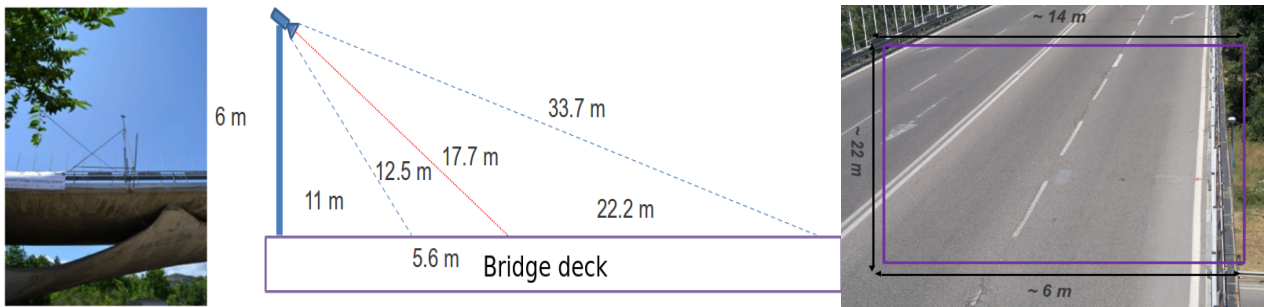

Figure 4: Experimental setup of the Infrared camera and its PoV.

Deployment of the whole prototype system, including a testing and setting the system before measurements started, took no more than half a working day, without any traffic interruption.

4. DATA ACQUIRED

This trial took place over four days, but our system was left in stand-alone acquisition mode only for three days. This time limitation was due to the time reserved for the assembly and dismantling operations required before and after the experiments in order to leave the bridge as it was before the experiments. Thanks to the infrared measurement system used, thermal images were acquired at a frame rate of 0.1 Hz by averaging 50 thermal images with an initial camera frame rate fixed at 5 Hz. Each hour, a thermal image sequence was stored on the internal hard drive of our system and data were also retrieved, on demand, using a wireless connection with a tablet PC. Figure 5 shows four thermal images of the thermal loading and cooling of the bridge deck under natural conditions monitored at different times.

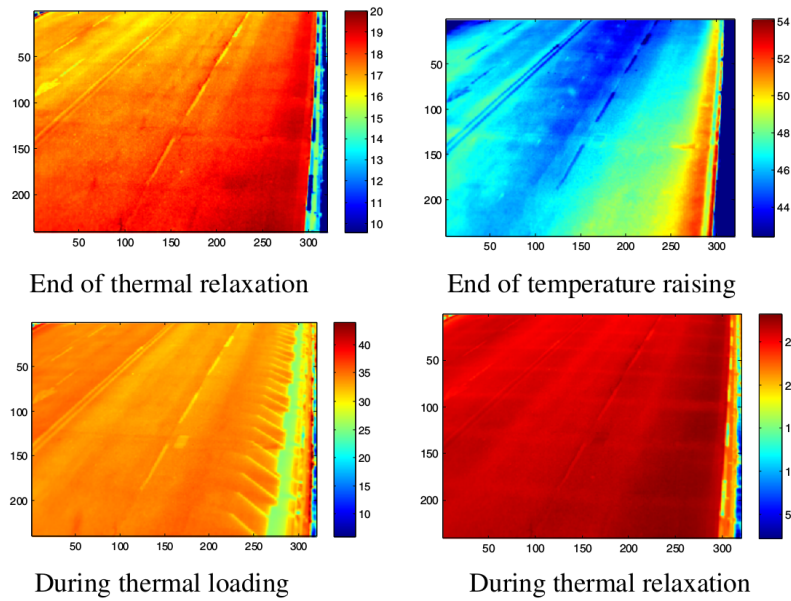

Figure 5: Thermal images in $^{\circ}\text{C}$ at different times of the day–night cycle (under natural thermal solicitation)

As the bridge deck is oriented S/E-N/O it is not located exactly in the solar axis, thus the body guard of the shadow appears on these thermal images. Note that the internal structure of the bridge is detectable during the thermal relaxation, this observation indicates that the information on the internal structure is contained in the thermal images measured. So it appears that a parameter estimation procedure could give us some interesting results.

Figure 6 (left graph) shows the external temperature and the wind speed evolution during experiments. On the third day a non-negligible raising of the wind speed (up to 100 km h^{-1}) can be observed, with a quasi-constant external temperature in parallel.

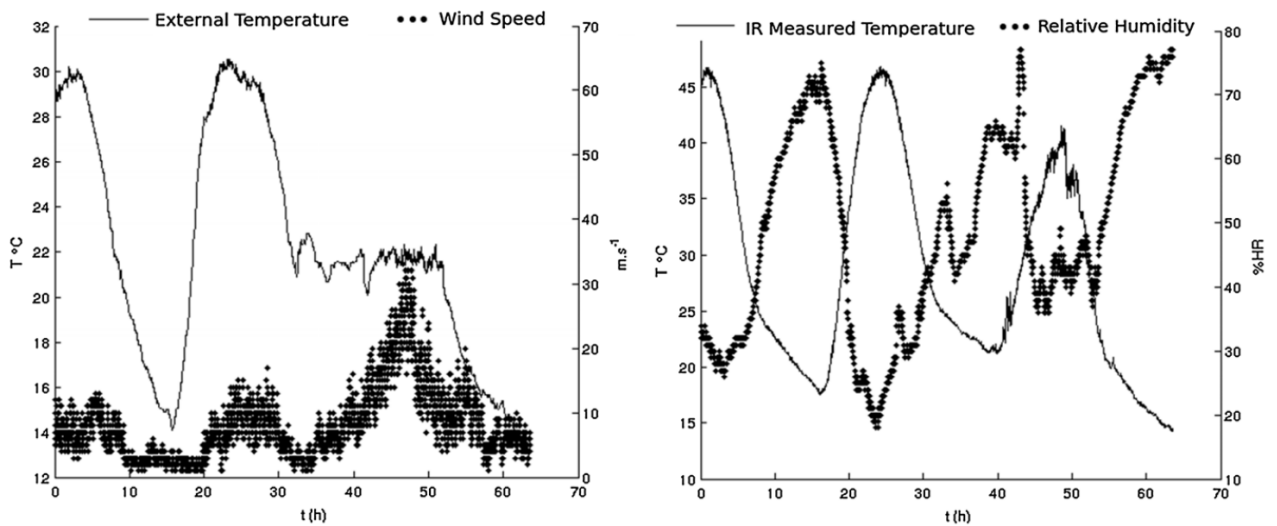

Figure 6: The measured atmospheric temperature over around 60 h and the wind speed during the same period (left); and the measured apparent temperature evolution by infrared thermography and relative humidity during the same period (right).

Figure 6 (right graph) shows an example of results for the apparent temperature evolution measured by infrared thermography during experiments. Thermogram was extracted from the

thermal image sequence acquired on site. The measured relative humidity shows a burst of humidity during the third day in particular. It matches the sudden wind event but also random sun shadowing by clouds and the external temperature stabilization. A combination of the convective effect and external temperature reduce the thermal relaxation during night time on the beginning of the third day.

5. THERMAL MODELING

If we focus the analysis on the first two days, the measured data have a periodic behaviour with a status close to the pseudo permanent regime. So the complex amplitude method can be used to solve the studied system. The system to solve is expressed in equation (1). Moreover, considering that the deck has a large thickness, but also considering its nature and the fact that we only look at a few daily periodic thermal perturbations at the deck surface, an adiabatic boundary condition was applied on the rear face of the deck:

$$\begin{cases} \frac{j\omega}{\alpha} \tilde{T}(\omega_n) = \frac{\partial^2 \tilde{T}(\omega_n)}{\partial x_a^2} \\ -k_a \left. \frac{\partial \tilde{T}(\omega_n)}{\partial x_a} \right|_{x=0} = \tilde{\varphi}(\omega_n) \\ -k_a \left. \frac{\partial \tilde{T}(\omega_n)}{\partial x_a} \right|_{x=e_a} = 0 \end{cases} \quad (1)$$

Where x is the space variable in m , k the thermal conductivity in $W.m^{-1}.K$, α the thermal diffusivity in $m^2.s^{-1}$ and $\omega_n=2\pi f$ the pulsation. To erase its influence on the calculus, ten periods made of a repetition of the initial day–night period considered were used for computing. The thermal properties estimation procedure is carried out during the seventh period. The model is solved thanks to the thermal quadrupoles method [9], expressed here for a single-layer material, equation (2):

$$\begin{pmatrix} \tilde{T}(\omega_n)_{x=0} \\ \tilde{\varphi}(\omega_n)_{x=0} \end{pmatrix} = \begin{pmatrix} \cosh \sqrt{j\omega_n} bR & \frac{1}{b\sqrt{j\omega_n}} \sinh \sqrt{j\omega_n} bR \\ b\sqrt{j\omega_n} \sinh \sqrt{j\omega_n} bR & \cosh \sqrt{j\omega_n} bR \end{pmatrix} \begin{pmatrix} \tilde{T}(\omega_n)_{x^*=R} \\ 0 \end{pmatrix} = \begin{pmatrix} A(\omega_n) & B(\omega_n) \\ C(\omega_n) & D(\omega_n) \end{pmatrix} \begin{pmatrix} \tilde{T}(\omega_n)_{x^*=R} \\ 0 \end{pmatrix} \quad (2)$$

As the equation (1) show an amount of correlation between its variable we decided to express the thermal quadrupole in terms of thermal resistivity, $R=e/k$ in $W.m^{-1}.K^{-1}$ and effusivity $b^2=k\rho C$ in $W.s^{1/2}.m^{-2}.K^{-1}$. Later in the paper we will focus on the thermal effusivity. The return in the time domain is carried out with the Fourier inverse transform computed on the model solution to express the time-dependant temperature, equation (3):

$$T(x=0, t) - T_m = \frac{1}{\sqrt{2\pi}} \int_0^{\omega_{fin}} \frac{A(\omega_n)}{C(\omega_n)} \tilde{\varphi}(\omega_n) \exp(j\omega_n t) d\omega_n \quad (3)$$

In order to lower the amount of data and optimize the computation time, the most regular daily period has been chosen and sub-sampled to 0.0083 Hz. As the solar heat flux wasn't measured during the trial we have to compute it. The global heat flux computation is based on the identification of the convective flux and the solar heat flux at the bridge deck surface. The convective heat transfer due to the wind effect on the bridge surface has to be taken into account, equation (4).

$$\varphi(t) = h_{\text{filtered}}(t) (T_{\text{external_filtered}} - T_{\text{measure_filtered}}) + \varphi_0(t) \quad (4)$$

A convective heat transfer coefficient, $h(t)$, is computed for each wind speed thanks to the

McAdams correlation [10]. Figure 7 (left) shows its evolution during measurements. The chosen temporal sub-sampling applied to the data preserve, at a convective heat transfer coefficient level, the global evolution of the wind during the trials. Furthermore, the bridge deck is subjected to a variable solar heat flux, dependant on the day and the season. Other parameters, like the slope and the solar angle, have to be considered. In this study, the Duffie and Beckman solar heat flux model [11] has been used. This model allows us to compute the theoretical solar heat flux received at a given time in a region of the world. The total solar heat flux is computed by adding its direct, diffuse and reflected components. Here the system studied is not located on side of a mountain and the slope of the bridge is neglected. To be coherent with our data, the solar heat flux has been computed for 24 h, thanks to information obtained by GPS, as well as the latitude. Figure 7 (right) shows the reconstructed solar heat flux, without cloud, for the first 24 h of measurements.

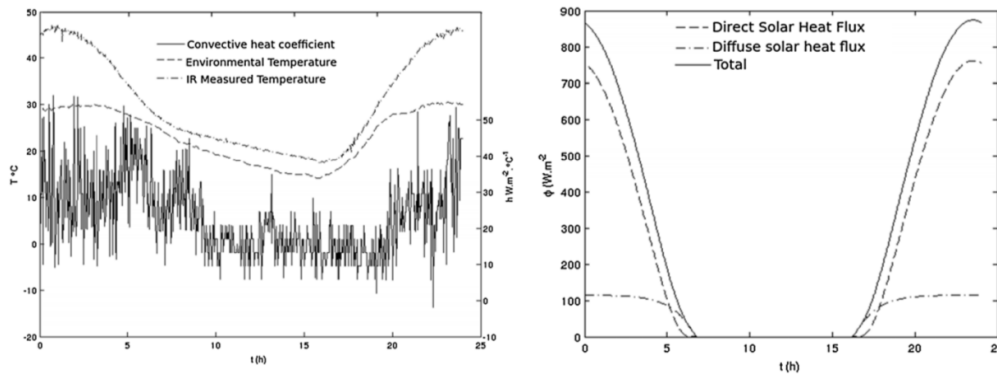

Figure 7: Sub-sampled measurements at 0.0083 Hz (left); and solar heat flux components (right).

6. ESTIMATION PROCEDURE AND GPGPU IMPLEMENTATION

The studied identification procedure needs filtered input data. The filtering of raw data reduces the effect of high frequency events which disturb the model with respect to the mean signal studied over 24 h. Thus a low-pass Butterworth filter has been applied to each piece of input data. Filtered data (figure 8 (left)) are used to compute the convective heat flux thanks to the determination of the convective heat transfer coefficient $h(t)$. Added to the solar heat flux $\phi_0(t)$, this allows the computation of the global heat flux $\phi(t)$ on the bridge deck surface:

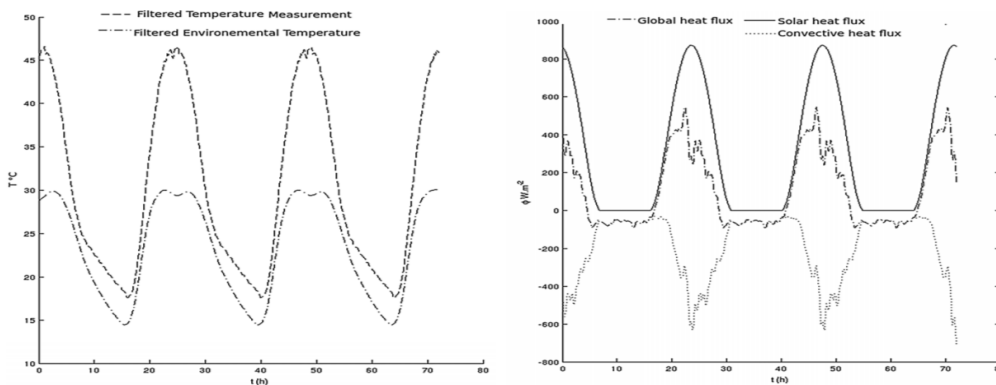

Figure 8: Filtered data (left); and computed heat flux (right).

As the studied period is repeated, the convective heat transfer coefficient also became periodic. The aim of the implemented estimation procedure is to determine the apparent thermal parameters of the bridge deck. Figure 9 shows a schematic view of the whole procedure studied and an illustration of result obtained. The Levenberg–Marquardt algorithm [12] was used for the minimization procedure.

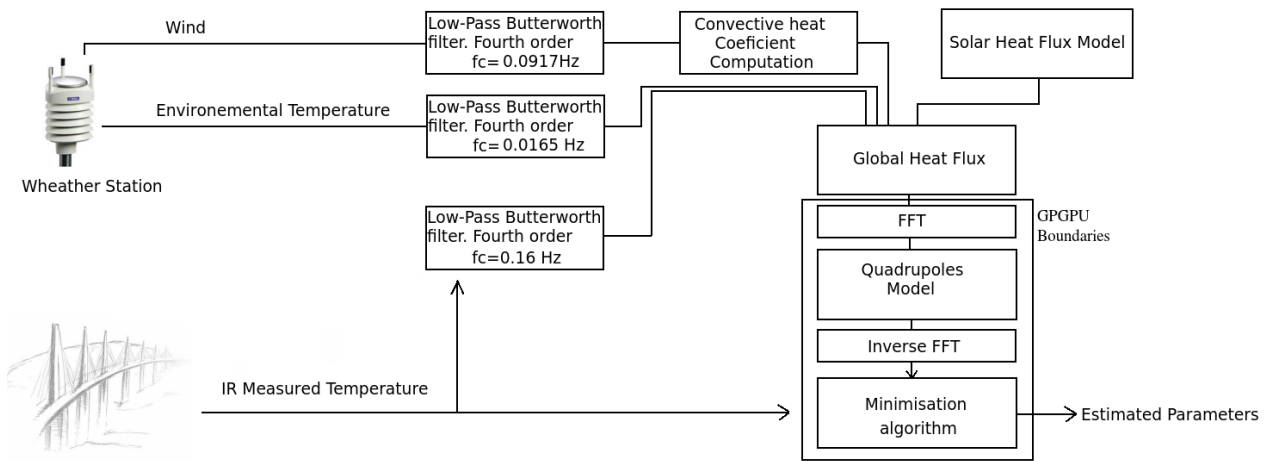

Figure 9: Scheme of the implemented estimation procedure

The figure 9 reveals the area concerned by the GPGPU improvement. A GPU, or graphics processing unit is a processor type dedicated to massive parallel operation, first used for image processing, after a while a certain number of researchers and engineers have started to use their highly parallel behavior to optimize general computing, that what we call GPGPU for General Purpose computing on GPU. For this study a custom GPU version of the Levenberg Marquardt algorithm have been build within Matlab software, as the model is solved in a frequency domain, GPU optimized FFT and inverse FFT are also used. Another possible optimization would have been to affect one GPU thread to each pixel over the measurement time, for that, this would have required the use of the dynamic parallelism paradigm [13], but for now we lack of hindsight on this technology. The calculus has been achieved on a personal computer (RAM : 8G, Proc :Intel®Core™i7 – 2860QM @2.50 GHz, OS : Ubuntu 12.04) providing a GPU card NVIDIA®GT 555M .

7. RESULTS

A spatial mean have been done to reduce the data to a 100x120px sequence. The non optimized version of the estimation procedure had a 70h computational cost. The first GPGPU implementation, slightly improved, has done the same job within 3h which give us 2300% of time gain. In order to compare and validate result an FFT has been compute on the same sequence, figure 10 left.

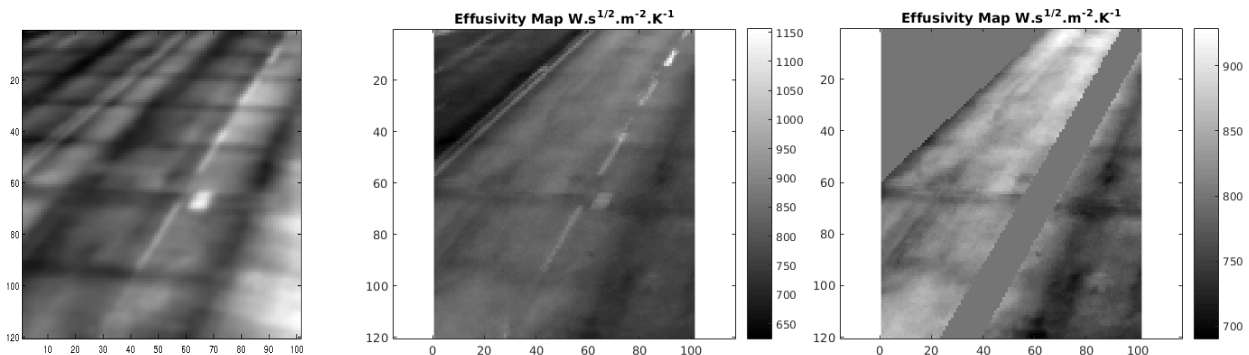

Figure 10: Fifth harmonic FFT phase map (left); Effusivity Map (middle); Masked effusivity map (right)

Comparing the FFT phase map to the effusivity map show that the estimation procedure, applied to the first period of the measurement, is able to detect and characterize any apparent variation in the properties of the deck structure; indeed the first caisson can be seen. However the surface condition of the structure, and the shadow, the spatial distortion due to the field of view of the camera and the emissivity approximation within the temperature conversion affect the model results. In order to correct the results a mask has been applied on the result, figure 10 (right), it highlight the variation on the apparent thermal effusivity implied by the deck inner structure. It could also seen that the traffic appear to reinforce the vertical beam.

8. CONCLUSION

The work conducted in this study relied on data acquired over several days on an open bridge to traffic. The measuring system used on the site is implementing a infrared camera microbolometer array and a meteorological station connected to a adequate information system. The analysis of the infrared image sequences was conducted using a thermal model and an identification protocol apparent thermal effusivity have been developed and studied. In addition the estimation procedure has been improved thanks to GPU first round of optimization, the effective time gain is about 2300% (from 70h to 3h) even if pure signal method as FFT are faster, our method give quantitative results about the inner structure composition. However, a second round of optimization could be able to provide a costless quantitative method and opens the way to follow up on the long term a possible indicator in connection with the aging of constituent materials of a structure subjected to climatic hazards and traffic.

REFERENCES

- [1] X.Maldague Theory and Practice of Infrared Technology for Non-destructive Testing (New York: Wiley) 2001
- [2] J.Dumoulin, R.Averty.R « Developement of an infrared system coupled with a weather station for real time atmospheric correction using GPU computing: Application to bridge monitoring » QIRT2012 NAPLES. 2012
- [3] J. Dumoulin et al The detection and thermal characterization of the inner structure of the ‘musmeci’ bridge deck by infrared thermography monitoring. Journal Of Geophysics And Engineering doi :10.1088/1742-2132/10/6/064003, 10:064003. 2013
- [4] A.Crinière et al. Thermographie infrarouge synchronisée avec la mesure de paramètres météorologiques : Application à l’auscultation du tablier d’un pont ouvert au trafic. In SFT 2013 Gerardmer France. 2013
- [5] A.Crinière. Contribution au développement d’outils d’analyse de séquences d’images infrarouges : Application au contrôle non destructif de structures de Génie Civil. Infrastructures de transport. Centrale nantes. PhD Thesis French. <tel-01111166> 2014
- [6] G. Gaussorgues, “La thermographie infrarouge : Principes, Technologies, Applications”, Tec Doc, Lavoisier, 3 e édition, 1989.
- [7] P.Shettle and R.W.Fenn, “Models for the aerosols of the lower atmosphere and the effects of

humidity variations on their optical properties”, Air Force Geophysics Laboratory 79-0214, (1979).

- [8] R.Capomolla. . Il ponte sul basento di sergio musmeci. il progetto della forma strutturale prima dell'avvento del calcolo automatico, In Atti del Primo Convegno Nazionale di Storia dell'Ingegneria, pp 1143–1152 2006
- [9] D.Maillet et al. Thermal Quadrupols - Solving the heat equation through integral transforms. WILEY. 2000
- [10]McAdams.W. Heat Tranmission. McGraw-Hill, New York. 1954
- [11]J.Duffie and W.Beckman Solar engineering of thermal process. John Wiley And Sons 1991
- [12]K.Levenberg. A method for the solution of certain non-linear problems in least-squares. Quart. Appl. Math, 2:164–168. 1994
- [13]N.Witt The CUDA Handbook A Comprehensive Guide to GPU Programming, Addison-Weasley , 2013