



HAL
open science

Design Space Exploration of Optical Interfaces for Silicon Photonic Interconnects

Olivier Sentieys, Johanna Sepúlveda, Sébastien Le Beux, Jiating Luo, Cedric Killian, Daniel Chillet, Ian O 'Connor, Hui Li

► **To cite this version:**

Olivier Sentieys, Johanna Sepúlveda, Sébastien Le Beux, Jiating Luo, Cedric Killian, et al.. Design Space Exploration of Optical Interfaces for Silicon Photonic Interconnects. 2th International Workshop on Optical/Photonic Interconnects for Computing Systems (OPTICS Workshop), co-located with IEEE/ACM Design Automation and Test in Europe (DATE'16), Mar 2016, Dresden, Germany. hal-01293506

HAL Id: hal-01293506

<https://inria.hal.science/hal-01293506v1>

Submitted on 24 Mar 2016

HAL is a multi-disciplinary open access archive for the deposit and dissemination of scientific research documents, whether they are published or not. The documents may come from teaching and research institutions in France or abroad, or from public or private research centers.

L'archive ouverte pluridisciplinaire **HAL**, est destinée au dépôt et à la diffusion de documents scientifiques de niveau recherche, publiés ou non, émanant des établissements d'enseignement et de recherche français ou étrangers, des laboratoires publics ou privés.

Design Space Exploration of Optical Interfaces for Silicon Photonic Interconnects

Olivier Sentieys¹, Johanna Sepúlveda¹, Sébastien Le Beux², Jiating Luo¹, Cedric Killian¹, Daniel Chillet¹, Ian O'Connor² and Hui Li²

¹INRIA, IRISA
University of Rennes
France

²Institut des Nanotechnologies de Lyon
Ecole Centrale de Lyon
France

Context: Evolution of the number of cores

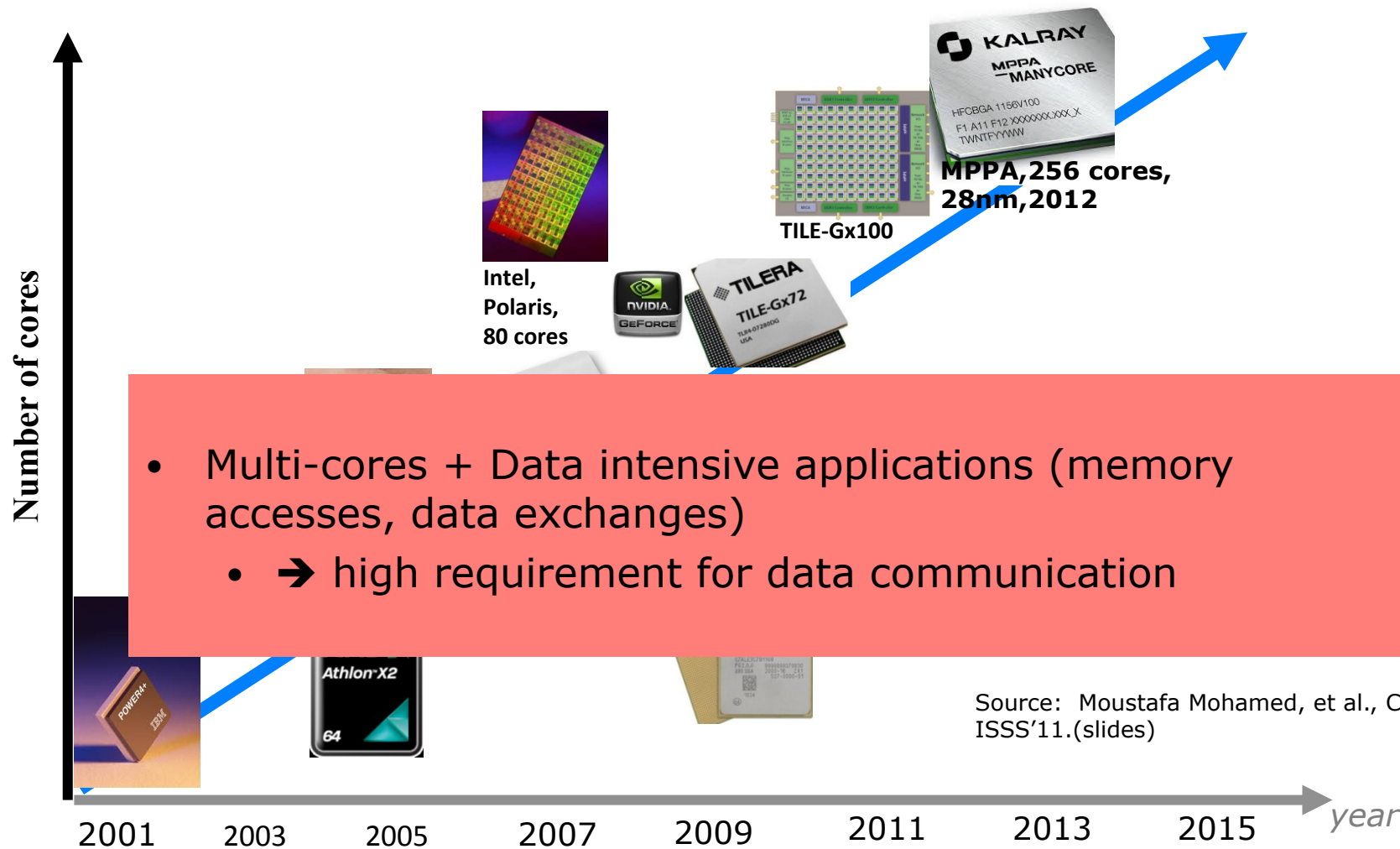

Challenges: higher **performances**, higher **power efficiency**, higher **integration**

Context: Optical interconnect

- Multi-cores + Parallel applications + memory needs + ...
 - → high requirement for data communication
 - Classical NoC → bottleneck !!
 - Need for more efficient communication infrastructure
 - Optical NoC could be a solution

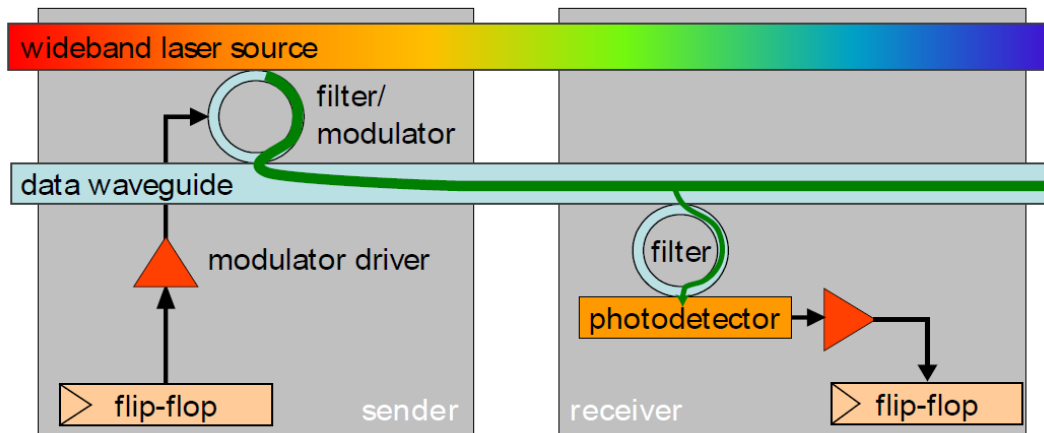

Source: G. Kurian, et al., PACT, 2010

- Silicon Photonics
 - High throughput: Wavelength Division Multiplexing, WDM
 - Lower dynamic energy
 - Lower latency

- We need design space exploration, in particular for Optical interface !!

Context: Needs for Design Methodologies

Easily programmable and power efficient processors

```
#INCLUDE <STDIO.H>
INT MAIN()
{
    PRINTF("HELLO, WORLD !");
    RETURN 0;
}
```

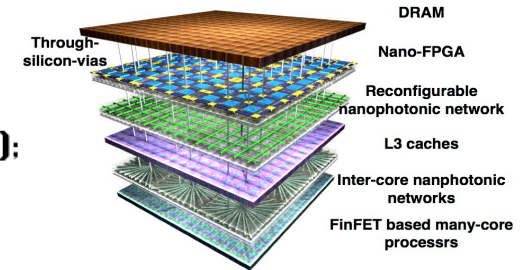

Key Focus of Design Space Exploration for 2 parts of the interface

- channel allocation
- laser power management

Key enabler:
Emerging technologies



DGFET



Silicon photonics

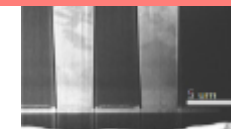

3D

- Context and problematic
- **DSE of waveguides and wavelengths allocation**
- DSE of laser power management
- Conclusion

Silicon Photonics Interconnects

Photodetectors

L. Vivien et al.,
Optics Express, 17, 6252 (2009)

Rx **Tx**

Electrical router

Micro-resonators

Z. Li et al. 2008

CMOS-compatible VCSEL
(Vertical-Cavity Surface-Emitting Lasers)

Source:

- C. Sciancalepore, et al. IEEE Photonics journal. 2012.
- Markus-Christian Amann and Werner Hofmann. IEEE journal of Selected Topics in Quantum Electronics, 2009.

Waveguide

Chameleon

Optical layer

TSV

IP core / cluster

Control network

Electrical layer

Router www.inria.fr

Communication schemes

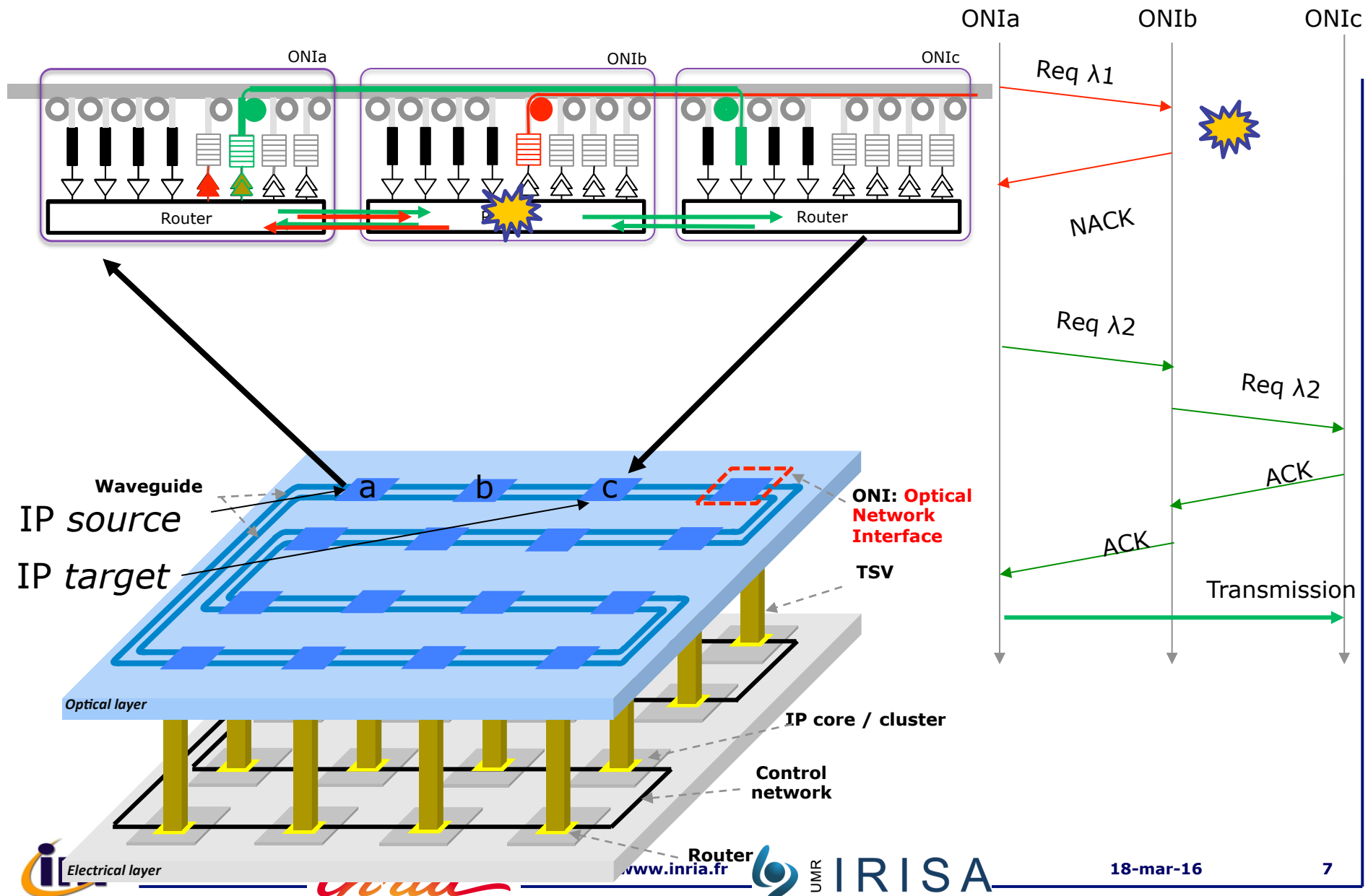

Channel size design tradeoff

Channel size:
number of
waveguides and
wavelengths per
request, i.e.
bandwidth

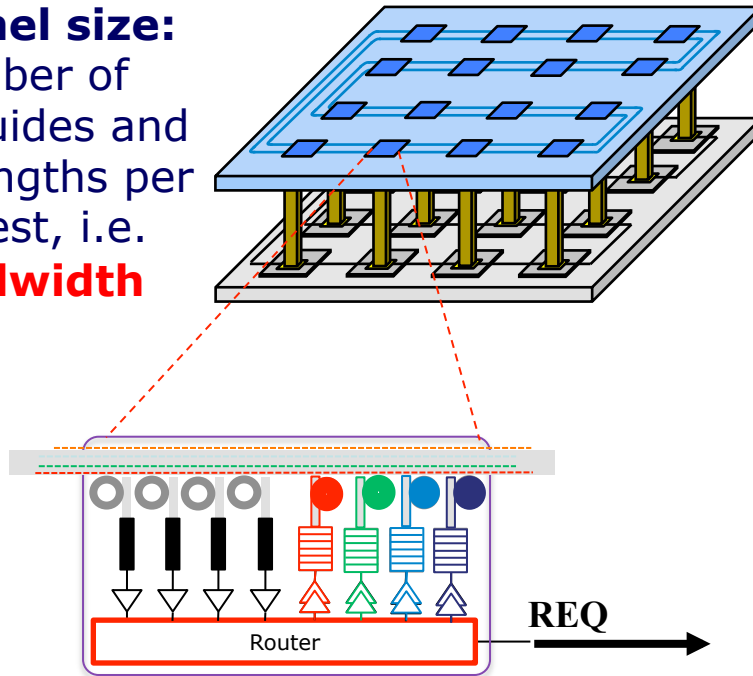

**data transfer time (optical domain)
versus
request latency (electrical domain)**

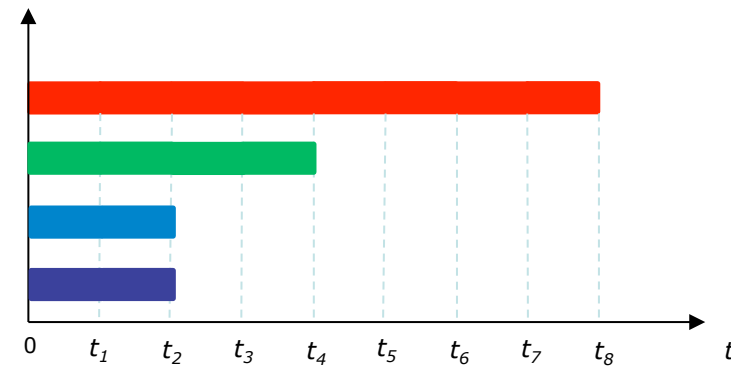

Best design option?

Simulation parameters



Models based on Gem5

- Quasi-cycle accurate simulator
- Integration of C++ models of optical components
- Based on Garnet NoC

Simulation characteristics

- Ring-based optical interconnection
- 8-tiles (ARM, 4-KB L1 cache) 32 bits channel width
- 2 architectures :
 - 4 waveguides, 16 wavelengths for each waveguide
 - 16 waveguides, 16 wavelengths for each waveguide
- Modulation speed: 10Gb/s
- Real application traffic (SPLASH-2)

Controller Synthesis Results

- 28nm FSDOI technology (Synopsys Design Vision environment)

Network size	4 waveguides		16 waveguides	
Channel size (wg, wl)	Area (um ²)	Power (mW)	Area (um ²)	Power (mW)
(16,16)	NA	NA	6292	2.09
(8,16)	NA	NA	6629	2.21
(4,16)	6292	2.09	7304	2.45
(2,16)	6629	2.21	8781	2.95
(1,16)	7304	2.45	13538	4.45
(1,8)	8781	2.95	17022	5.06
(1,4)	13538	4.45	21385	5.33
(1,2)	17022	5.06	30110	5.86
(1,1)	21385	5.33	47560	6.92

Simple controllers

More complex controllers

Results: SPLASH-2 benchmark

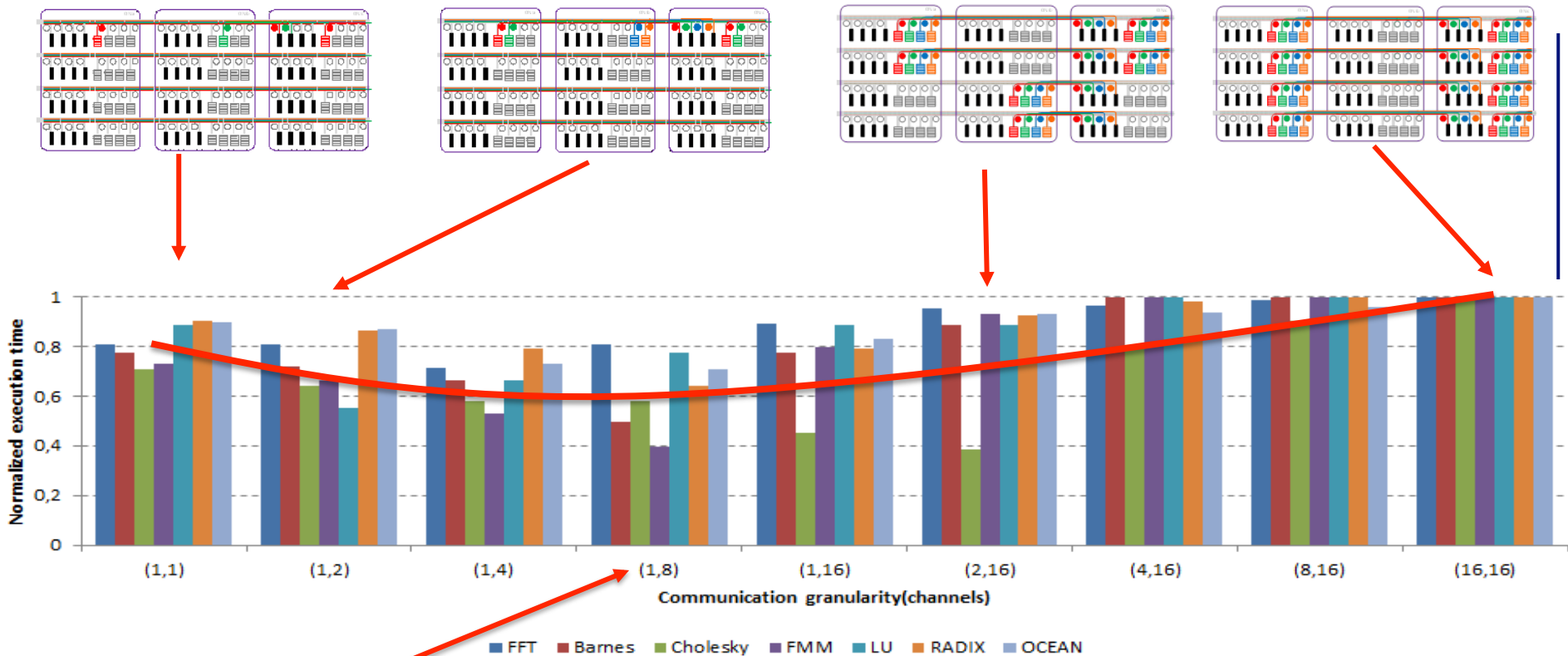

Best channel size: 1 waveguide, 8 wavelengths

Sepuulveda15] Communication Aware Design Method for Optical Network-on-Chip
 J.Sepúlveda, S.Le Beux, J.Luo, C.Killian, D.Chillet, H.Li, I.O'Connor, O.Sentieys

- Context and problematic
- DSE of Waveguides and wavelengths allocation
- **DSE of laser power management**
- Conclusion

Impact of the waveguide sharing

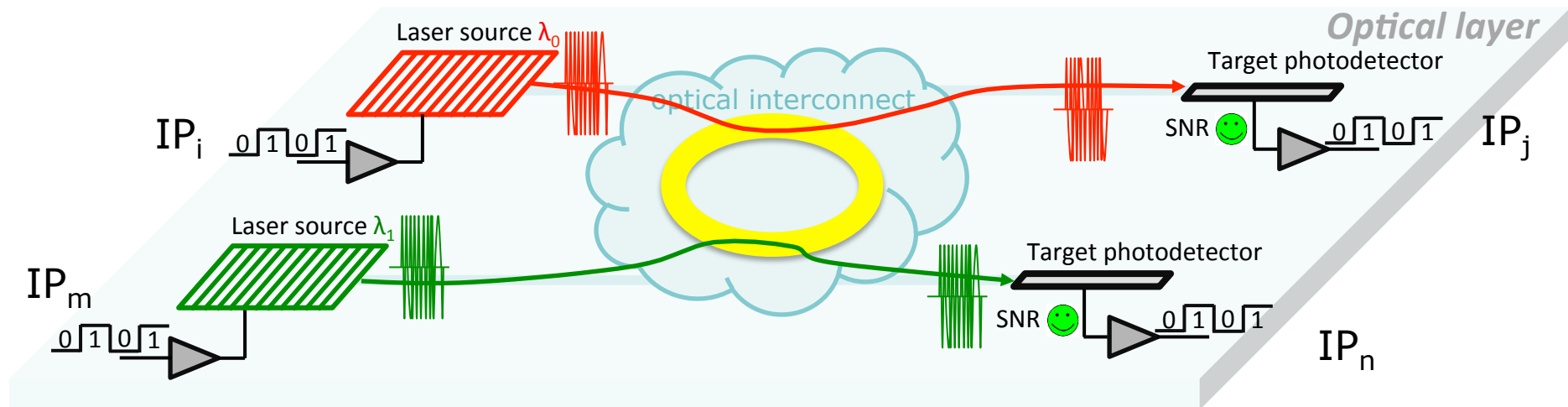

- ❑ **Communication between 2 pairs of Ips**
 - ❑ One wavelength for each communication
 - ❑ **No conflict between communications**
- ❑ **Laser power at nominal value**

Impact of the waveguide sharing

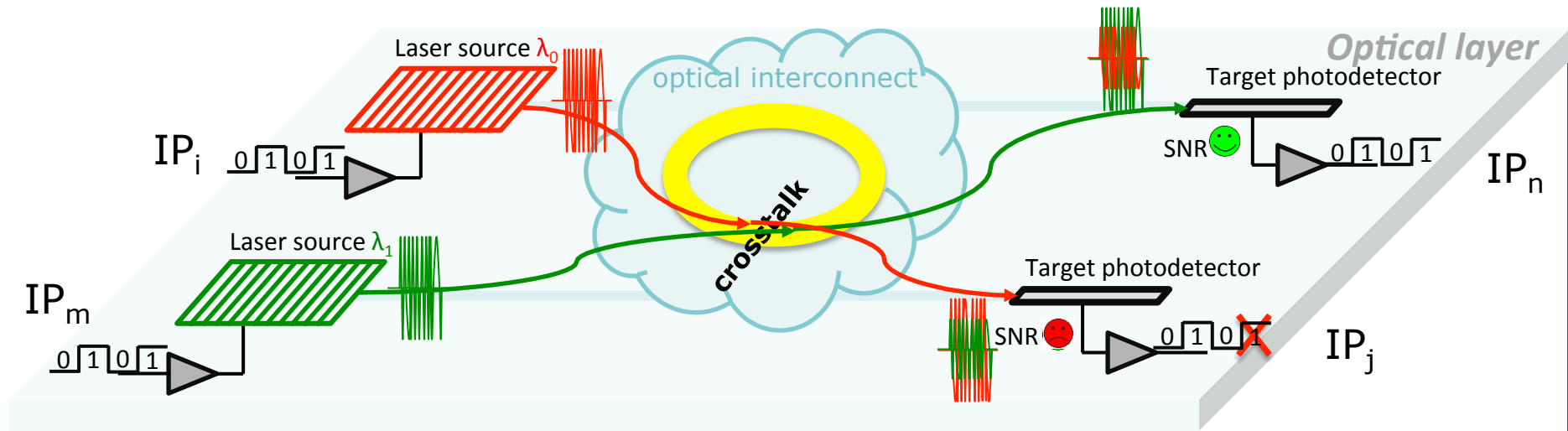

- ❑ **Communication between 2 pairs of Ips**
 - ❑ One wavelength for each communication
 - ❑ **Temporal and spatial conflicts in the waveguide**

- ❑ **Laser power at nominal value**
 - ❑ SNR ↘ BER ↗

Impact of the waveguide sharing

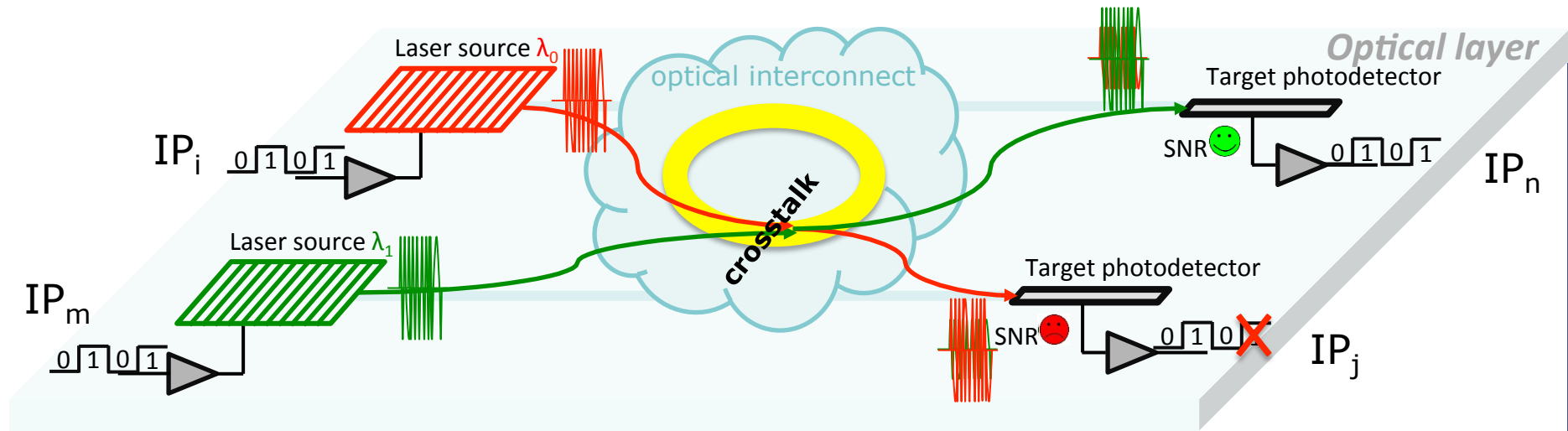

❑ How can we manage SNR and BER ?

❑ Laser power can be ↗

❑ SNR ↗ BER ↘

Impact of the waveguide sharing

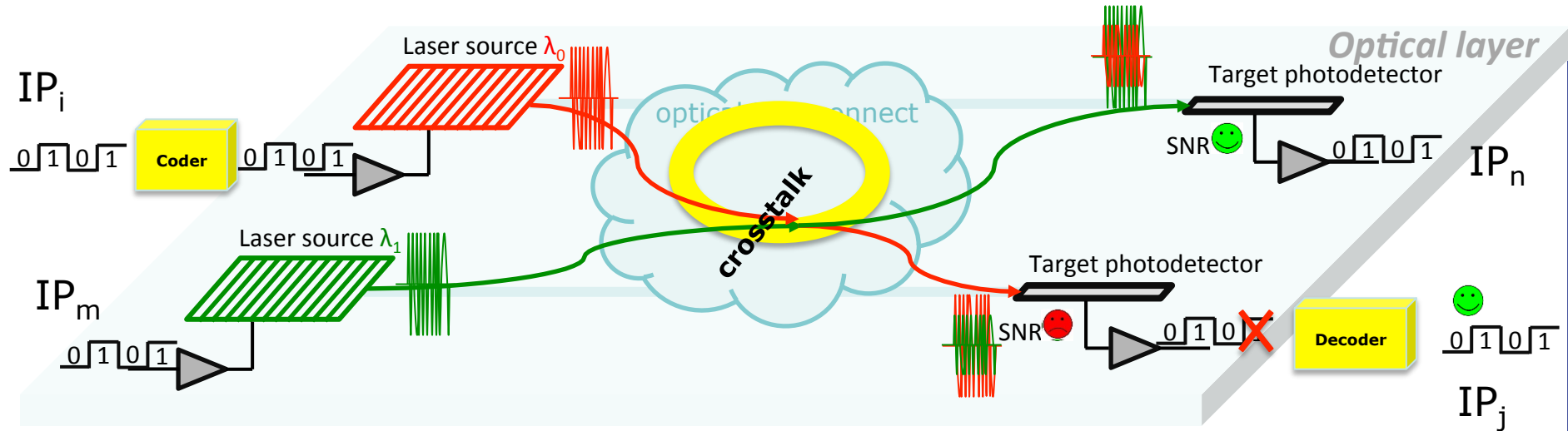

❑ How can we manage SNR and BER ?

❑ Laser power can be ↗
 ❑ SNR ↗ BER ↘

❑ Or ECC can be included in the communication channel
 ❑ SNR = BER ↘ but BW ↘

Impact of the waveguide sharing

- **Strategy**

- **How to find a good tradeoff between**

- management of laser power
 - introduction of codec in the channel

- **Could be supported by the allocation protocol**

- req. and ack. messages can help to estimate the loss in the optical channel

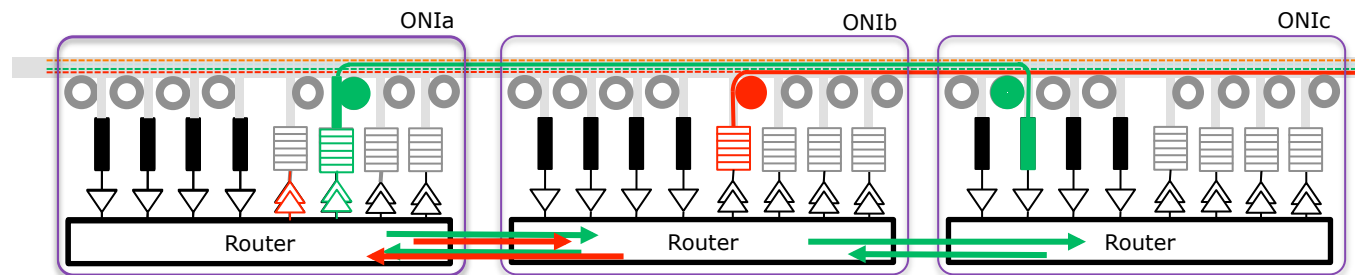

- Context and problematic
- DSE of Waveguides and wavelengths allocation
- DSE of laser power management
- **Conclusion**

Conclusion and future works

- ❑ Optical NoC Interface design
 - ❑ critical issue in silicon photonics interconnects → need DSE at different levels
 - ❑ low level DSE/management
 - ❑ laser power and ECC
 - ❑ high level DSE/management
 - ❑ channel allocation / allocation protocol
- ❑ Future works
 - ❑ tradeoff between Electric vs Optic energy performances
 - ❑ on-line strategy for channel allocation
 - ❑ *thermal aware design method*

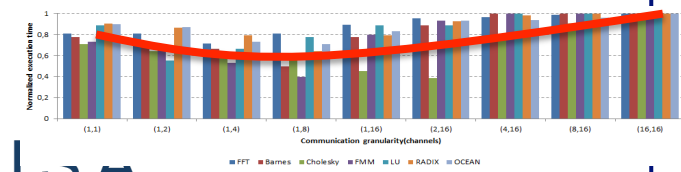
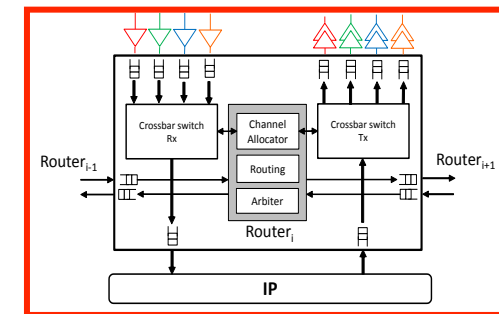
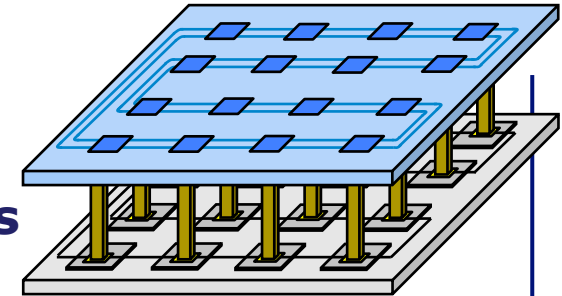

Design Space Exploration of Optical Interfaces for Silicon Photonic Interconnects

Olivier Sentieys¹, Johanna Sepúlveda¹, Sébastien Le Beux², Jiating Luo¹,
Cedric Killian¹, Daniel Chillet¹, Ian O'Connor² and Hui Li²

Thank you !

Questions ?