



HAL
open science

Ontologies and datasets for energy measurement and validation interoperability

Strahil Birov, Simon Robinson, María Poveda Villalón, Mari Carmen Suárez-Figueroa, Raúl García Castro, Jérôme Euzenat, Bruno Fies, Andrea Cavallaro, Jan Peters-Anders, Thanasis Tryferidis, et al.

► To cite this version:

Strahil Birov, Simon Robinson, María Poveda Villalón, Mari Carmen Suárez-Figueroa, Raúl García Castro, et al.. Ontologies and datasets for energy measurement and validation interoperability. [Contract] Ready4SmartCities. 2015, pp.135. hal-01247616v2

HAL Id: hal-01247616

<https://inria.hal.science/hal-01247616v2>

Submitted on 22 Dec 2015

HAL is a multi-disciplinary open access archive for the deposit and dissemination of scientific research documents, whether they are published or not. The documents may come from teaching and research institutions in France or abroad, or from public or private research centers.

L'archive ouverte pluridisciplinaire **HAL**, est destinée au dépôt et à la diffusion de documents scientifiques de niveau recherche, publiés ou non, émanant des établissements d'enseignement et de recherche français ou étrangers, des laboratoires publics ou privés.



READY4SmartCities - ICT Roadmap and Data Interoperability for Energy Systems in Smart Cities

Deliverable D3.3: Ontologies and Datasets for Energy Measurement and Validation Interoperability v2

Document Details

Delivery date:	M23
Lead Beneficiary:	<i>empirica Gesellschaft für Kommunikations- und Technologieforschung mbH</i>
Dissemination Level (*):	PU
Version:	2.0
Preparation Date:	03/07/2015 – 09/09/2015
Prepared by:	<i>Strahil Birov (EMP), Simon Robinson (EMP), María Poveda-Villalón (UPM), Mari Carmen Suárez-Figueroa (UPM), Raúl García-Castro (UPM), Jérôme Euzenat (INRIA), Bruno Fies (CSTB), Andrea Cavallaro (DAPP), Jan Peters-Anders (AIT), Thanasis Tryferidis (CERTH/ITI), Kleopatra Zoi Tsagkari (CERTH/ITI)</i>
Reviewed by:	<i>Jerome Euzenat (INRIA), Andrea Cavallaro (DAPP)</i>
Approved by:	<i>Coordinator (DAPP), Technical Coordinator (UPM)</i>

(*) Only one choice between:

- PU = Public
- PP = Restricted to other programme participants (including the Commission Services)
- RE = Restricted to a group specified by the consortium (including the Commission Services)
- CO = Confidential, only for members of the consortium (including the Commission Services)

Project Contractual Details

Project Title:	ICT Roadmap and Data Interoperability for Energy Systems in Smart Cities	
Project Acronym:	READY4SmartCities	
Grant Agreement No.:	608711	
Project Start Date:	2013-10-01	
Project End Date:	2015-09-30	
Duration:	24 months	
Project Officer:	Svetoslav Mihaylov	

Revision History

Date	Author	Partner	Content	Ver.
1 July 2015	Strahil Birov	EMP	Deliverable structure	1.1
15 July 2015	Strahil Birov Simon Robinson	EMP	Part A draft	1.2
July - August 2015	Strahil Birov María Poveda-Villalón Jérôme Euzenat Bruno Fies Andrea Cavallaro Jan Peters-Anders Kleopatra Zoi Tsagkari	EMP UPM INRIA CSTB DAP AIT CERTH/ITI	Part B update: sections 5 - 10	1.3
5 August 2015	Strahil Birov Simon Robinson	EMP	Part A completion of sections 2, 3 and 4	1.4
10 August 2015	Andrea Cavallaro	DAPP	Overall quality check	1.5
27 August 2015	María Poveda-Villalón Strahil Birov	UPM EMP	Part B update with partner input for sections 8 and 9	1.6
1 September 2015	Jérôme Euzenat	INRIA	Overall quality check	1.7
2 September 2015	Strahil Birov Simon Robinson	EMP	Adoption of reviewers' comments after the quality check	1.8
3 - 8 September 2015	Simon Robinson María Poveda-Villalón Jérôme Euzenat Bruno Fies Andrea Cavallaro Jan Peters-Anders Kleopatra Zoi Tsagkari	EMP UPM INRIA CSTB DAP AIT CERTH/ITI	Final checks, conclusions	1.9
9 September 2015	Strahil Birov Simon Robinson Andrea Cavallaro	EMP DAPP	Handover to project coordinator and delivery to the EC	2.0

The present Deliverable reflects only the author's views and the Community is not liable for any use that may be made of the information contained therein.

Statement of originality:

This deliverable contains original unpublished work except where clearly indicated otherwise. Acknowledgement of previously published material and of the work of others has been made through appropriate citation, quotation or both.

Statement of financial support:

The research leading to these results has received funding from the European Community's Seventh Framework Programme (FP7/2007-2013) under grant agreement no. FP7-SMARTCITIES 2013-608711

Executive Summary

This document presents a final report of the work carried out as part of work package 3 of the READY4SmartCities project, whose goal it is to identify the knowledge and data resources that support interoperability for energy measurement and validation. The document is divided into two parts.

Part A reflects on a “change of gear” approach after the first year of the project according to which, in addition to collecting ontologies and datasets, greater effort has been directed at stakeholders and users of the project results, to further assist them in making use of the collected knowledge and to understand how to best approach them with regards to this new topic. This change of gear has become possible as the necessary foundation to providing useful guidance to stakeholders had been laid down through project work in year one.

The change of gear in the second project year has seen greater activity in engaging relevant stakeholders and providing them with the necessary tools and assistance to work towards interoperable data for energy measurement and validation.

Work package three has focused on working together with European municipalities. As a result of these efforts as well as hosting of events such as VoCamps, a common ontology to be used for transformation of municipal consumption energy data into Linked Open Data was developed with the active participation of municipality representatives. The ontology assists European municipalities during the Linked Data generation process.

Another result of the stakeholder engagement efforts was the development of real use cases that support Linked Data exploitation, as it became clear that stakeholders would only spend effort and money when there is a concrete problem to solve and not just the rather intangible promise of better interoperability. To this end, based on the dataset coverage of the municipalities the project worked with, a use case for comparing energy consumption data of public buildings was developed and described in detail in ‘D4.3 Requirements and guidelines for energy data exploitation’.

The use case and the available materials produced by the consortium (e.g. the catalogue of ontologies and datasets, available alignments, the municipality ontology, the guidelines for generation and exploitation of Linked Open Data, etc.) provide a strong basis for any stakeholder interested in improving data interoperability in Smart Cities through the power of Linked Data.

Part B introduces the methods and processes followed for collecting and analysing ontologies and datasets. Methods have been co-developed with WP2 in respect of the interoperability area energy management systems. The common process for identifying and collecting relevant resources is first updated (chapters 6-7) from what presented in previous version of this deliverable, followed by a description of the resources collected, namely relevant ontologies, datasets and alignments and links among them (chapter 7).

For the collection of ontologies and datasets, a special online catalogue ensures that resources are collected and recorded in a standardised way. The catalogue also allows for ease of understanding and use in terms of submission of new content, visualisation of existing resources and handling of recorded items. For the collection of alignments, an alignment server identifies and documents links and alignments among the identified ontologies and datasets.

Various collection methods were used in order to identify and collect relevant ontologies, datasets and explore possible alignments. The methods include the set-up and administration of an online survey addressed to relevant experts, stakeholders in the domains identified in the previous deliverable, literature review by the study team, analysis of standardisation and institutional bodies, and screening of resource catalogues.

Ontologies were collected using a semi-automatic process, engaging contributors, who suggested which ontologies to be included in the catalogue, populators, who added new ontologies directly into the catalogue online, and metadata curators, who reviewed, improved and completed the metadata of ontologies already in the

catalogue. As a result, 70 ontologies were included in the catalogue during the whole project duration (32 ontologies in the first year, and 38 in the second year of the project).

The current ontology offer represented in the catalogue provides full coverage of the domains defined for Level 1 (Temporal, Organisational, Statistical, Spatial/Geographical, and Measurement) and only two domains of the level 2 (Energy, climate zone, weather, environmental, building, occupancy, user behaviour) are not covered, namely climate zone and environmental. In addition, a number of new domains not identified before as part of Level 1 nor Level 2 are covered by the ontologies in the catalogue.

Current availability of Open Linked Data(sets) related to energy in general was found to be quite limited. Nine datasets were collected in the first year, and ten new dataset have been included for this second and final version.

Gap analysis revealed deficits in the supply of ontologies and datasets in both interoperability areas. Though the catalogue of ontologies appears quite large, some ontologies are very specialised and others very generic, leaving some relevant conceptual areas with poor coverage. As with ontologies, the current availability of open linked data falls very short of what could be envisioned. For both domains, energy management systems and energy measurement and validation, there is a significant opportunity to improve the offer of ontologies and to encourage publication of more linked open data.

The work carried out in work package 3 and in cooperation with work package 2 provides a solid basis for any stakeholder wishing to take advantage of linked data by providing the necessary tools in the form of a comprehensive catalogue with available ontologies and datasets. This technical basis combined with the comprehensive guidelines produced as part of work package 4 enables stakeholders to produce Linked Data and raises awareness of the opportunities it offers Smart Cities towards becoming interoperable.

Glossary

Alignment	The result of analyzing multiple vocabularies to determine terms which are common across them.
Dataset	A collection of RDF data, comprising one or more RDF graphs that is published, maintained, or aggregated by a single provider. In SPARQL, an RDF Dataset represents a collection of RDF graphs over which a query may be performed.
Linked Data	A pattern for hyperlinking machine-readable data sets to each other using Semantic Web techniques, especially via the use of RDF and URIs. Enables distributed SPARQL queries of the data sets and a browsing or discovery approach to finding information (as compared to a search strategy). Linked Data is intended for access by both humans and machines. Linked Data uses the RDF family of standards for data interchange (e.g., RDF/XML, RDFa, Turtle) and query (SPARQL).
Ontology	A formal model that allows knowledge to be represented for a specific domain. An ontology describes the types of things that exist (classes), the relationships between them (properties) and the logical ways those classes and properties can be used together (axioms).
Open Data	Refers to content that is published on the public Web in a variety of non-proprietary formats.
OWL	Web Ontology Language (OWL) is a family of knowledge representation and vocabulary description languages for authoring ontologies, based on RDF and standardized by the W3C.
RDF	Resource Description Framework (RDF) is a family of international standards for data interchange on the Web produced by W3C. RDF is based on the idea of identifying things using Web identifiers or HTTP URIs, and describing resources in terms of simple properties and property values.
SKOS	Simple Knowledge Organisation System (SKOS) is a vocabulary description language for RDF designed for representing traditional knowledge organization systems such as enterprise taxonomies in RDF.
SPARQL	SPARQL Protocol and RDF Query Language (SPARQL) defines a query language for RDF data, analogous to the Structured Query Language (SQL) for relational databases. It is a family of standards of the World Wide Web Consortium.
URI	A global identifier standardized by joint action of the World Wide Web Consortium and Internet Engineering Task Force. A Uniform Resource Identifier (URI) may or may not be resolvable on the Web. URIs can be used to uniquely identify virtually anything including a physical building or more abstract concepts such as colours.
VoCamp	A VoCamp is an informal event where people can spend some dedicated time creating lightweight vocabularies/ontologies for the Semantic Web/Web of Data. The emphasis of the events is not on creating the perfect ontology in a particular domain, but on creating vocabularies that are good enough for people to start using for publishing data on the Web.

Table of Contents

Executive Summary	3
Glossary	5
1 Introduction.....	8
1.1 Purpose and Methodology	8
1.2 Document Structure	8
1.3 Contribution of partners	9
Part A: Bringing Linked Open Energy Data to Europe’s Municipalities	10
2 Approach to municipality support and dataset prioritisation.....	10
2.1 Country selection	10
2.1.1 UK policy on (Linked) Open Data	10
2.1.2 The UK Open Data landscape and developments.....	11
2.2 Municipality selection and dataset prioritisation	12
2.3 Municipality contact and engagement.....	13
2.4 Support to municipalities.....	13
3 Targeted municipalities.....	15
3.1 Bristol – Europe’s green capital 2015	15
3.2 Leicester – towards a low carbon city	16
3.3 Birmingham – sustainable and better future for all citizens.....	18
4 Results.....	20
4.1 An energy measurement vocabulary for municipalities.....	20
4.2 Use case development for European municipalities	21
Part B: Ontologies and Datasets for Energy Management Systems Interoperability v2	22
5 Collection of ontologies and datasets	22
5.1 Stakeholder involvement.....	22
5.2 Review literature for ontology seeking	23
5.3 Review literature for datasets.....	24
5.4 Analysis of Standardization and Institutional Bodies.....	25
5.5 Lookup Resource Catalogues.....	26
6 Recording of ontologies and datasets.....	28
6.1 Ontology catalogue	28



6.2	Dataset catalogue	30
6.3	Alignments catalogue.....	32
6.3.1	Overview of the Alignment server	32
6.3.2	Methodology of alignment generation.....	34
6.4	Overview of ontologies and datasets gathered during the first and second project years	37
6.4.1	Ontologies, vocabularies and standards.....	37
6.4.2	Datasets	43
6.4.3	Ontology alignments.....	44
7	The Interoperability Areas: Energy Management Systems and Energy Measurement and Validation.....	52
8	Collected ontologies	61
8.1	Gap analysis	61
8.2	List of ontologies	62
9	Collected datasets	118
9.1	Gap analysis	118
9.2	List of datasets.....	119
	Conclusions.....	133
	References	135

1 Introduction

1.1 Purpose and Methodology

Work package 3 of the Ready4SmartCities project aims at identifying the knowledge and data that can support interoperability in energy measurement and validation by identifying and assessing relevant ontologies, vocabularies and standards, as well as relevant datasets and alignments.

With the current report this goal has been fully reached. At the end of the project, a total of 70 ontologies and 18 datasets have been identified and catalogued, and alignments among them have been explored. These resources were allocated between the work packages following the methodology and strategy developed as part of deliverable D2.1/D3.1. Deliverable “D3.2 Ontologies and Datasets for Energy Measurement and Validation Interoperability v1” presented this first version of the set of ontologies, datasets and alignments found by the partners and analysed as relevant to the work package domains.

Work on identification of ontologies and datasets has continued, and this document presents an updated version of this work. Also, in line with project objectives, greater effort has been directed at stakeholders and users of the project results, to further assist them in making use of the collected knowledge. This change of gear which the consortium was encouraged to pursue after the first project review has become possible as the necessary foundation to providing useful guidance to stakeholders had been laid down through project work in year one. At the end of that year we had a working catalogue of the gathered ontologies and datasets, first alignments between these, and guidelines to transforming datasets into Linked Open Data.

The change of gear in the second project year has seen greater activity in engaging relevant stakeholders and providing them with the necessary tools and assistance to work towards interoperable data for energy measurement and validation. This work has given rise to a number of interesting results, and complements the extension of the ontology, dataset and alignment catalogue, which are shared between WP2 and WP3. We have therefore adopted the following structure for this deliverable:

- 1) Activities and results from the changed gear approach documented in ‘Part A’ of this deliverable are unique to WP3, with municipalities as the target stakeholders. The sub-title for the deliverable reflects this: “Bringing Linked Open Energy Data to Europe’s Municipalities”.
- 2) Building on deliverables D3.2, D3.3 and D2.3 jointly provide an updated version of the collected ontologies, datasets and alignments for interoperability of energy management systems and energy measurement and validation. This update is presented as ‘Part B’ and, unlike the solution adopted for reports D3.2/ D2.2, this part is common for both work packages. This second version now contains **all** information on ontologies, datasets and alignments produced by the consortium in work packages 2 and 3 during the whole lifespan of the project.

1.2 Document Structure

The deliverable is divided into three parts.

Part A reports on the efforts to engage European municipalities and assist them in publishing relevant energy data as Linked Open Data. Sections 2 – 4 discuss the country and municipality selection, the offered support instruments, and the results of this change of gear approach.

Part B is an update of deliverables D2.2 and D3.2 and is common for work packages 2 and 3. Sections 5 – 9 document the collection of ontologies and datasets, their documentation using catalogues and a server, as well as a comprehensive list and description of the collected 70 ontologies and 18 datasets during the project lifetime, accompanied by a gap analysis.

Finally, the conclusions based on work in work packages 2 and 3 are presented.

1.3 Contribution of partners

Empirica has the main responsibility to produce this document. The following states which partners have contributed to the different sections of the deliverable:

Partner	Resources planned	Contributions to sections
EMP	6.5 PM	WP lead, organisation of telephone conferences jointly with WP2 partners Contributions to all sections
UPM	4 PM	Contribution to sections 5 – 9
INRIA	5 PM	Contribution to sections 5, 6, 7 and 9
DAPP	1 PM	Contribution to sections 8 and 9
CSTB	0.5 PM	Contribution to section 8
AIT	0.5 PM	Contribution to section 8

Part A: Bringing Linked Open Energy Data to Europe's Municipalities

2 Approach to municipality support and dataset prioritisation

2.1 Country selection

Against the background that the project is a support action with a high proportion of research tasks, and given the fact that Linked Open Data is an emerging trend that requires sound arguments in order to convince stakeholders to adopt it, WP3 partners took a pragmatic approach in selecting targets and content for engagement with stakeholders. Simple criteria were applied to prioritise the community engagement work, and as a result the team focussed on municipalities in the United Kingdom - this was seen as the country with highest potential to engage the target community of municipalities. As one of few member states the UK has a quite developed policy with regards to Linked Open Data (LOD), there is good availability of a pool of Open and even Linked data, and there are existing ties between some of the project partners and UK municipalities. Given the time constraint the latter point was seen as critical.

2.1.1 UK policy on (Linked) Open Data

The UK has an advanced policy on Open Data compared to many other EU countries, and has engaged Tim Berners-Lee in developing this policy. Linked Open Data is even there a new direction for achieving interoperability (representing five stars using the Five Star Scheme), and a high awareness of the importance of Open Data is a prerequisite for successful engagement of stakeholders who are expected to engage in LOD-related activities.

The UK is ranked number one in the world for its leadership in open data by the Open Data Barometer. For more than a decade, UK governments of various political parties have built on the open data initiatives of their predecessors to encourage open data to be released and reused across government: from the launch of the Power of Information Review by the Blair government in 2007, to the implementation of the data.gov.uk open data portal under the Brown government in 2009, to David Cameron's letter to cabinet ministers in 2010, affirming previous progress in open data and setting out the coalition's transparency agenda.

The UK's world leadership in government open data is a result of a number of initiatives and actions - setting up the Public Sector Transparency Board (PSTB)¹, the Open Data User Group (ODUG)² and the Open Data Institute (ODI)³, introducing the first Open Government Licence⁴, becoming the inaugural chair of the Open Government Partnership, shaping the G8 Open Data Charter⁵, rolling out the Release of Data and Breakthrough Funds⁶ and initiating strategic discussion of a UK National Information Infrastructure⁷.

¹ <https://www.gov.uk/government/groups/public-sector-transparency-board>

² <https://www.gov.uk/government/groups/open-data-user-group>

³ <http://opendatainstitute.org/>

⁴ <http://www.nationalarchives.gov.uk/doc/open-government-licence/version/2/>

⁵ <http://ec.europa.eu/digital-agenda/en/news/eu-implementation-g8-open-data-charter>

⁶ <https://www.gov.uk/government/publications/breakthrough-fund-and-release-of-data-fund>

⁷ <https://www.gov.uk/government/publications/national-information-infrastructure>

While there is no policy document addressing Linked Open Data alone, the topic was addressed in detail in the White Paper “Open Data: Unleashing the Potential” presented to parliament in 2012. The document seeks to lay out what citizens, businesses and the public sector can expect from government to help unlock the benefits of Open Data. It sets out clearly how the UK will continue to unlock and seize the benefits of data sharing in the future in a responsible way. When referring to the format of data, the paper points out that LOD is an ultimate goal which is hard to reach, but that by having a uniform framework, the data landscape will be improved:

*“The Government intends to adopt the **Five Star Scheme** as a measure of the usability of its Open Data. We know that not all our data is of the highest level of usability but, through using the Five Star Scheme for labelling datasets, we are **working towards improving the data landscape**. We are not setting targets for data usability; responsibility for evaluating the costs and benefits of enhancing data usability will be devolved to data owners in each public authority. **Departmental engagement with users**, a key requirement of the Open Data Strategies, will be essential in determining whether the benefits of improving data usability justify any associated cost.”*

Departments, or generally municipalities, need to be assisted in exploring what benefits can be provided to users and associated costs that accrue. This exploration is best done using examples based on real data the departments have. We see a supporting role for READY4SmartCities precisely in this phase – helping to bring Linked Open Data-level of quality to municipalities as part of their efforts to open up their data to users.

2.1.2 The UK Open Data landscape and developments

The Open Data Institute (ODI)

The Open Data Institute was set up in 2012 to catalyse the evolution of an open data culture to create economic, environmental and social value. In the last two years it has trained governments and industry, nurtured start-ups, developed tools, produced research and stories, grown its international network and provided expert guidance on how to unlock the full potential of open data. In consultations with its members, start-ups and stakeholders across the UK open data community, the ODI began sketching out steps the UK could take to continue to drive progress on open data. What began as detailed plans for action across all areas of open data, spanning quality of publication, management of data assets, release of high value data and funding for data education programs, was gradually refined and pared back to a high level Roadmap for Open Data in the UK⁸.

www.data.gov.uk

The Government is releasing public data to help people understand how government works and how policies are made. Some of this data is already available, but data.gov.uk brings it together in one searchable website. Making this data easily available means it will be easier for people to make decisions and suggestions about government policies based on detailed information.

The **demand** for UK open government data appears to be increasing. For example, between January 2010 and September 2012, the average number of page views per dataset on data.gov.uk increased by 285 per cent, and the number of ‘clicks’ on download links increased by 166 per cent, despite total dataset numbers increasing from 2,879 to 8,675. However, from a READY4SmartCities perspective it is a challenge to learn that energy-related datasets are among the least searched on the website⁹.

www.legislation.gov.uk

The availability of legislation as Open Data on www.legislation.gov.uk has enabled the National Archives to develop a new, transferable operating model for updating government databases. A high-quality data interface

⁸ <http://theodi.org/roadmap-uk-2015>

⁹ see Deloitte: „Open growth: Stimulating demand for open data in the UK”, 2012. Most popular types of data searched include economy, demographics, government operations, business, population health, social conditions, etc.

makes it easy for anyone to access legislation data by adding '/data.xml' or '/data.rdf' to any web page containing legislation, or '/data.feed' to any list or search results. Data can be re-used free of charge under the Open Government Licence. This has enabled the development of several third-party applications, including two smartphone apps and a service for law lecturers to create and self-publish relevant extracts of legislation for their courses.

www.legislation.gov.uk gives businesses easy access to legislation data, which they can include in their own products and services. The public benefits from more up-to-date legislation, while business benefits from developing value-added products and services. All the data is of consistently high quality, remaining public, open and free.

Department for Communities and Local Government (DCLG)

The DCLG is currently trialling a selection of its housing, local government finance and deprivation statistics in the Five Star form. The datasets are available in the demonstration 'Open Data Cabinet' (<http://opendatacommunities.org>), which was launched in April 2012. The Department is working closely with a small group of local authorities and voluntary organisations to test and demonstrate the power and potential of linking DCLG and third-party sources over the web, using open standards. Early results are reported to be highly encouraging.

Alongside the data cabinet, DCLG has launched a demonstration Local Authority Dashboard (<http://opendatacommunities.org/dashboard>). This is reported to be successful as a means to showcase and promote Open Data and standards to a non-technical audience, believed to strengthen engagement with users, and help to shape the Department's move towards routinely releasing all data in open, accessible and re-usable forms.

2.2 Municipality selection and dataset prioritisation

Energy measurement and validation data is already available from many municipalities, who typically publish consumption data for all municipal buildings. Complementary data needed for the validation (e.g. adjustment to heating degree days) can also be provided directly by the municipalities or by third parties. Energy production is also of interest, which is why related datasets have been added to the online catalogue.

The selection criteria for UK municipalities are the following (in descending order of importance):

- **Existing ties and knowledge:** municipalities one or more project partners have previously worked with, with experience with European projects, and a proven interest in innovation in their approach to energy saving and interoperability. Such are more likely to be engaged quickly and effectively in READY4SmartCities;
- **Advanced public data services:** municipalities who have already made some steps towards LOD are likely to be more receptive and willing to be engaged compared to municipalities in which only the minimum of data is made public and LOD is not even a topic yet. The characteristics which help to identify the level of awareness of municipalities regarding (Linked) Open Data are:
 - *Relevant data:* when selecting municipalities, their data has to be energy related, more specifically measurement and validation relevant, in order to be of interest to Ready4SmartCities;
 - *Data portal:* having a portal to publish relevant data is a prerequisite for any possible collaboration, as through portals the data is available to a wider audience and can be obtained and inspected;
 - *Open data (optional):* the municipal data would be preferably already in an open format (on the web, structured and in a non-proprietary format), which allows to focus on the last step of linking the available open data;
 - *RDF (optional):* if a municipality is already experimenting with and publishing in RDF format, such cases are of interest because Ready4SmartCities can assist in talking about future strategies and exploitation scenarios, similar to the scenarios being analysed as part of Task 4.3.

2.3 Municipality contact and engagement

Based on the described selection criteria, suitable municipalities were contacted. The scope of engagement included assistance using project materials, events organised by the project consortium, and personal contact in order to analyse the data landscape of the municipalities and explore possible synergies between them (e.g. discussion of who benefits how from Linked Open Data, approaches and related efforts, local support, etc.).

In the period February – July 2015 representatives of the selected municipalities were approached by email exchange, followed by telephone conferences. The follow-ups have been either by mail or by attending project events, such as the VoCamp in Vienna in April 2015.

2.4 Support to municipalities

Support to the selected municipalities has been provided by the project partners in different forms.

A comprehensive set of materials

A set of comprehensive guidelines for energy data generation (D4.1), publication (D4.2) were made available as downloadable documents on the project website. The guidelines are complemented by examples and suitable tools and techniques are recommended, forming a cookbook for stakeholders interested in publishing Linked Open Data for interoperability purposes.

In addition, the online catalogue of relevant ontologies and datasets (<http://smartcity.linkeddata.es/>) serves as a repository of necessary resources applied when generating Linked Open Data. The catalogue, which is result of combined WPs 2 and 3 efforts, is continuously being updated with new content and features and is explained in more detail in section 6.1.

Furthermore, as for DoW, informative documents - even to inform lay people - were provided to address different topics in the relevant domains. For the area of energy Key Performance Indicators (KPIs), Empirica used experience from previous EU projects to author the paper “KPIs for S.M.A.R.T. Cities”, presented at the 1st Workshop organised by the EEB Data Models Community¹⁰, to inform stakeholders of the potential of KPIs in this domain. Specifically for municipalities, KPIs are valuable as representing aggregated data about performance (e.g. energy performance of museum buildings in Bristol) which is used to inform policy in order to better govern and steer processes, organisation and infrastructure, leading to continuous efficiency improvements. KPIs can help municipalities make better decisions regarding planning of energy efficiency measures and actions. KPIs so understood are an integral part of the approach to Linked Open Data worked on with UK municipalities.

Training and engagement events

Stakeholder support through events has proven particularly effective, and has engaged key actors from municipalities, setting off on a Linked Open Data course. Participants gather hands-on experience in Linked Data generation and resources are developed that can be reused by others, thus contributing to community development. The following events have been held as part of stronger community engagement efforts in the second project year:

- A VoCamp entitled “Energy measurement data in municipalities” (22-23 April 2015) was organised in Vienna, specifically targeted at municipalities. The aim of the VoCamp was to co-design a common ontology (hereafter referred to as the municipal ontology) that can be used by municipalities to represent their energy measurement data in order to publish such data online as Linked Data. The resulting product is available at

¹⁰ Proceedings of the 1st Workshop organised by the EEB Data Models Community ICT for Sustainable Places
Nice, France, 9th-11th September, 2013

<http://smartcity.linkeddata.es/LD4SC/def/ontology/>. All participants were invited to attend upcoming events supported by Ready4SmartCities.

- In June 2015 the first “Summer School on Smart Cities and Linked Open Data” was held under the umbrella of Ready4SmartCities in Cercedilla, a municipality of the autonomous community of Madrid in central Spain. The main goal of the summer school was to teach people from industry and academia in an easy and guided way how to use Linked Open Data technologies in the domain of smart cities, facilitating through a simple approach a first contact with these technologies. The event targeted a broader circle of stakeholders, among which were also municipal representatives.
- A VoCamp to be held on 14-15 September 2015 in Genova will be the last of the series of VoCamps the project has organised to be used as a platform for information exchange among relevant stakeholders. The VoCamp will focus on future scenarios for cities' energy systems, as developed in the READY4SmartCities Roadmap for Energy Systems in Smart Cities.



VoCamp „Energy measurement data in municipalities“, 22-23 April 2015, Vienna

Further support

During talks with municipality representatives it became clear that for some, technical support is not the first step. Prior to seeking support, municipalities need to understand the arguments as to why an LOD approach will be beneficial and justify the effort required. As with Open Data, making a clear case for Linked Data is not trivial. In economics terms, Linked Data has the characteristics of a network good, that is, benefits arise through network effects, a special form of externality, exhibiting critical mass effects and generally such that the greater the number of networked goods, the greater the potential benefit. In the case of network goods, significant benefits tend to be visible only sometime after the approach has been adopted.

This argument is a difficult one when the target stakeholders are under pressure to justify resource use usually by documenting real benefits materializing for them and citizens in the short term. The network effects apply therefore at municipality level again, as without short term evidence of their own benefits, they need to be able to point to other municipalities who started earlier and are reaping benefits. Such use cases and case studies illustrating best practice in LOD and payoff for municipalities are not yet available, so that the target had to be municipalities convinced of the potential and willing to lead their peers. Through collaboration, such use case has been developed and is described in section 4.2.

Our efforts to engage the community of municipalities, starting with select UK municipalities, therefore addressed two fronts:

1. Providing technical assistance through materials, hands-on sessions and follow-up discussions to those who are willing to adopt early and are ready to make the necessary steps towards linking municipal data.
2. Discussing possible developments and the steps to be taken in this regard with those who are still reluctant to invest into linking their data, and need more evidence and arguments to support such undertaking, taking into account their specificities

3 Targeted municipalities

After applying the selection criteria to the list¹¹ of municipalities created by the project partners, three UK municipalities were further engaged with by the consortium: Bristol, Birmingham and Leicester. The characteristics of these municipalities the support provided and results obtained are described in the following sections.

3.1 Bristol – Europe’s green capital 2015

Bristol was awarded the European Green Capital status in 2015 due to the city’s well established record of achieving high environmental standards, it’s commitment to ongoing and ambitious goals for further environmental improvement, and it’s function as a role model – part of a growing group of cities that aim to inspire and promote best practices to all European cities. Involving Bristol in our Linked Data activities therefore seems logical and provides a solid ground for approaching other municipalities in the region.

Current developments related to energy data interoperability

A feasibility study¹² in 2012 outlined the vision of Bristol in the years up to 2030. The city aims to cut CO₂ emissions by 40% by 2020, provide more efficient and affordable transport, improve health and wellbeing, and create 95,000 new jobs by 2030. The way towards these goals is encompassed in the concept of a City as a platform. As cities around the world start to experiment with open data to create economic value, there is an increasing recognition that releasing data is not enough on its own. Government is no longer the provider of end user experience but the provider of a foundation for others to build on.

Creating a world class City Operating Platform that unlocks economic value and other benefits requires at its heart, the integration of City systems. Integrating City systems, technically and organisationally, allows more data and infrastructure to be put at the disposal of innovative organisations and citizens.

The approach to integration outlined in the study involves development of an operating system that is to be designed on open, published, scalable standards, permitting the integration of further systems in future. Open Data is at the heart of the platform, and any proprietary data will be transformed and integrated into the platform.

One of the key challenges identified in the study is unlocking data: “City data and information is often managed by siloed teams or organisations. Work will need to take place to identify benefits and challenges for any particular data owner or information curator to allow access to their information.”

Linked Open Data in Bristol

Bristol City Council (BCC) publishes energy consumption and (soon) production data. One of the key questions arising is about the best formats to publish data.

As a starting point, BCC uses the Socrata platform to manage and publish the data. Socrata provides software solutions exclusively for digital government. With the Socrata Open Data Platform, citizens get access to the data and can review, compare, visualise and analyse the data in real time. For the Council, the platform is convenient because it offers endpoints that can be easily accessed programmatically.

The Council is aware that the Socrata platform offers RDF format, but has not explored it further due to a lack of use cases or problems.

¹¹ Other municipalities on the list: Cardiff council, Florence, Lecce, Fingal County

¹² Connect Bristol Feasibility Study, Bristol City Council, November 2012

“The Bristol area has a lot of expertise in Linked Data. Our platform allows conversion to RDF (Linked Data format) but this is not something we have explored much further as there hasn’t been a real-life problem to solve.”
 – Matthew Cockburn, Project Coordinator, Bristol City Council

Unfortunately the use of a platform such as Socrata limits the possibilities of cooperation between BCC and the Ready4SmartCities partners. With a proprietary system in place, the generation and publication guidelines produced in work package 4 cannot be applied. Nevertheless we identified specific points that can be worked on in the future towards making the case for putting Linked Data in Bristol centre stage:

- 1) Consumption data of public buildings provided by Bristol City Council as part of the EU project SMARTSPACES¹³ has been provided. The Ready4SmartCities project has used it to make a use case as part of work package 4 which deals with data exploitation.
- 2) Data from Bristol was used in the generation of the municipality ontology during one of the VoCamps organised by the Ready4SmartCities. The specific dataset used was data on solar panels and monthly installed solar photovoltaic capacity and energy consumption in Bristol public buildings.

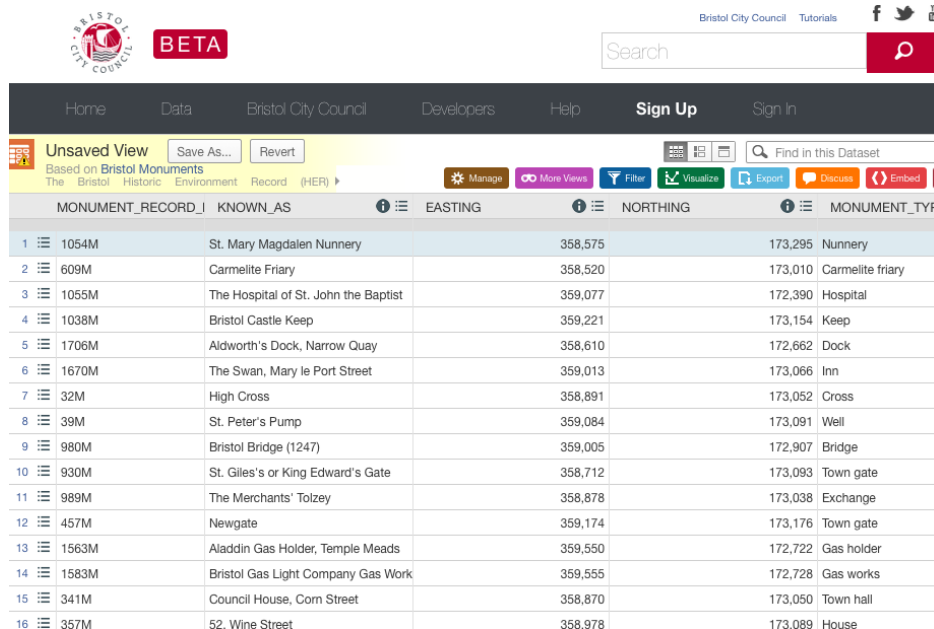

MONUMENT_RECORD_ID	KNOWN_AS	EASTING	NORTHING	MONUMENT_TYPE
1	St. Mary Magdalen Nunnery	358,575	173,295	Nunnery
2	Carmelite Friary	358,520	173,010	Carmelite friary
3	The Hospital of St. John the Baptist	359,077	172,390	Hospital
4	Bristol Castle Keep	359,221	173,154	Keep
5	Aldworth's Dock, Narrow Quay	358,610	172,662	Dock
6	The Swan, Mary le Port Street	359,013	173,066	Inn
7	High Cross	358,891	173,052	Cross
8	St. Peter's Pump	359,084	173,091	Well
9	Bristol Bridge (1247)	359,005	172,907	Bridge
10	St. Giles's or King Edward's Gate	358,712	173,093	Town gate
11	The Merchants' Tolzey	358,878	173,038	Exchange
12	Newgate	359,174	173,176	Town gate
13	Aladdin Gas Holder, Temple Meads	359,550	172,722	Gas holder
14	Bristol Gas Light Company Gas Work	359,555	172,728	Gas works
15	Council House, Corn Street	358,870	173,050	Town hall
16	52, Wine Street	358,978	173,089	House

Figure 1. A Bristol dataset used in developing the municipality ontology

3.2 Leicester – towards a low carbon city

Leicester is the largest UK city outside London with an elected Mayor and, under this strong leadership and cross party commitment built up over the last two decades, has an international track record of delivering environmental work. The city is very active in its aim to reduce carbon emissions by 50%. Data integration and interoperability are key steps towards this goal, and are expected to bring the city different benefits, such as making city facilities and services better aligned, more efficient, targeted and accessible to the end user.

Current developments related to energy data interoperability

During talks with representatives of Leicester City Council it was pointed out that there is hardly any funding for energy data interoperability activities in the city, and that Leicester has applied for different EU projects over the

¹³ <http://smartspace.eu/>

years, but has been mostly unsuccessful. Funding and support in the UK for such activities is provided by the *Technology strategy board*, now known as *Innovate UK*, who have their own budget for future smart cities.

“Leicester has applied for different EU projects over the years, but has been mostly unsuccessful.” – P. Fleming, Director of Sustainable Development at De Montfort University, working together with Leicester City Council

In cooperation with *Innovate UK*, a feasibility study is being conducted, proposing city-scale integrated management of energy supply and demand in Leicester. The aim is to integrate the low carbon city objective with affordable homes, jobs, quality of life, young people, culture and sport. The feasibility study allows for identifying the most appropriate low carbon interventions to make on a citywide scale to help improve quality of life for those living and working in Leicester.

Further cooperation with *Innovate UK* led to Leicester participating in a new £1 million project won by sustainability consultancy Ricardo-AEA. The project will build and evaluate a ‘prototype data platform’ for cities – enabling them to model energy demand and savings opportunities from an individual building level right through to the city-wide scale. To be known as the Energy Data Integration System (EDIS), the platform’s key innovation will be its ability to access and combine real data from local authorities and utility providers, modelling actual energy demand behaviour patterns across an entire city. This will revolutionise energy planning and investment for councils and utility providers. The infrastructure will be scalable to allow hosting and modelling similar data sets such as air quality and transportation information.

Linked Open Data in Leicester

After brief introduction into Linked Open Data and the Ready4SmartCities project, Leicester City Council representatives expressed the opinion that it is a very interesting and relevant topic for the Council. Generally different departments in the city are happy to share data in order to manage the city more efficiently. The lack of funding is, however, a major hurdle for any related undertakings. However, Leicester did commit to the following:

- 1) Provide related data to be integrated into a Linked Open Data use case developed together with Bristol and Birmingham consumption data. The use case is described in more detail in section 4.2.
- 2) Participate in the VoCamp and contribute to developing a ontology for municipalities that covers concepts and vocabularies used by other European municipalities who provide building consumption data, such as the SMARTSPACES municipalities – Hagen, Venlo, Moulins, Lleida, Murcia, Milan, Belgrade, and Istanbul.



Figure 2. A Leicester dataset used in developing the municipality ontology

3.3 Birmingham – sustainable and better future for all citizens

Birmingham is the most populous British city outside London, with an economy dominated by the service sector. There are numerous public services in the domains housing, health, planning, transport, etc. which all center on bringing benefits to citizens.

Current developments related to energy data interoperability

In 2014 the Birmingham Smart City Roadmap was launched, which sets out over 35 actions that aim to influence the city's approach to creating a sustainable and better future for its citizens by responding to challenges such as unemployment, the skills gap, health inequalities, effective mobility and carbon reduction targets. The Roadmap has been developed by the Birmingham Smart City Commission, a body created by the city council which includes leading figures from the business, academic and public sectors, supported by Digital Birmingham. It represents a collective ambition by city stakeholders to deliver real change by developing intelligent and integrated services through the use of digital technologies, data and open collaboration, driven by the citizens and communities that are core to the city's future growth.

The three intrinsically linked themes of Technology & Place, People and Economy underpin the roadmap's 39 proposed actions, to be delivered over the next three years, identifying funding through European, national and regional programmes.

Action H1 of the Roadmap called "Energy data (open data) and visualisation" aims to enable sourcing and releasing data about energy consumption as public open data where possible on Birmingham's open data portal. Starting with the Council's own data, the next step will be to persuade external data owners to release their data. Secondly to help individuals and organisations better understand their own energy usage, particularly how and when energy is used and comparison with that of similar households or buildings through energy dashboards and visualisation, with appropriate protection of individuals' privacy. The Council's short term actions include working with different organisations and projects such as the Climate KIC-Transition project, the Smart City Alliance and

the Smarter Greener Eastside initiative to gain greater access to energy usage data in Eastside and make this available as open data. The future actions are to develop a citywide data / systems architecture for resource data (gas, electricity, heat, fuel, water, waste) and to engage with and encourage citywide public and private organisations to release energy data, and review feasibility of gaining access to commercial data¹⁴.

Linked Open Data in Birmingham

As part of the EU project SMARTSPACES, Birmingham City Council provides a website for users and developers to access and reuse building energy data on three municipal buildings – the Birmingham Council house, Margaret Street (Council House extension), and Birmingham Museum and Art Gallery. Access is provided via two points – an Open Data query page for users (<http://www.energysmartbirmingham.com/web/guest/data-reader>) and an API for developers (<http://data.energysmartbirmingham.com/api/>).

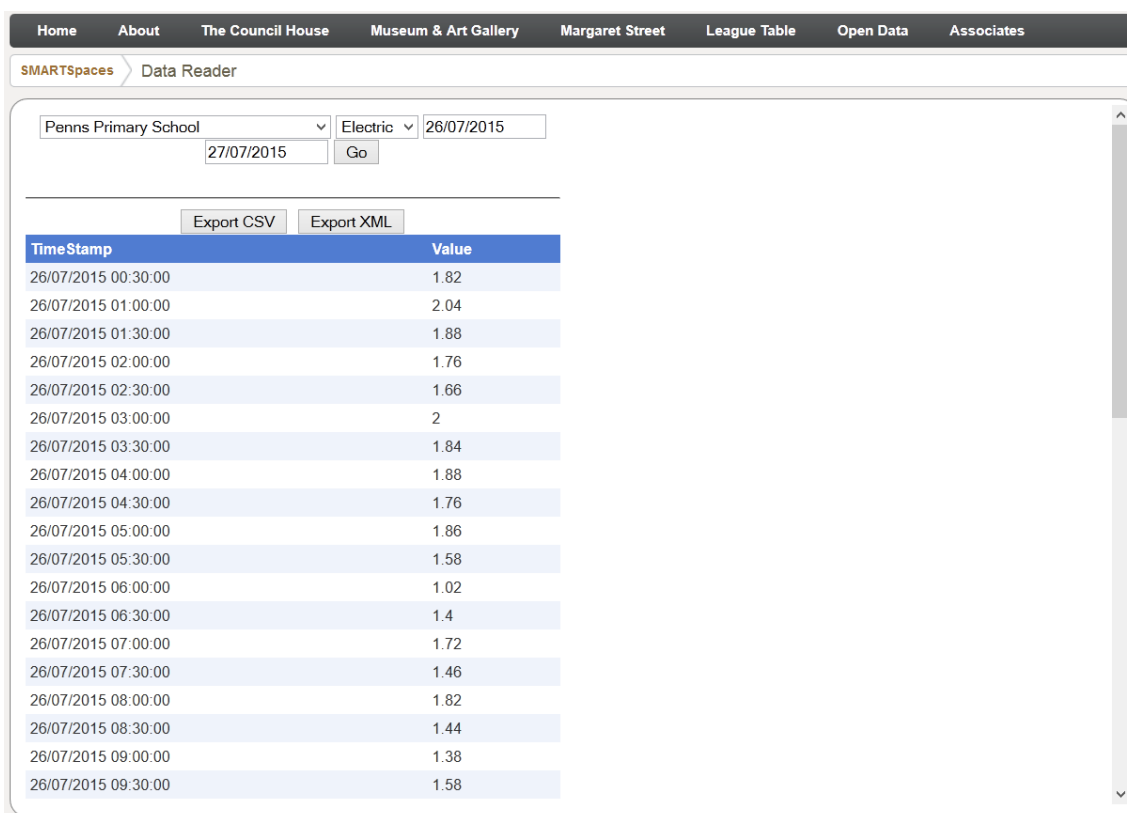

Figure 3. Birmingham data portal with consumption values of public buildings in the city

¹⁴ <https://birminghamsmartcity.wordpress.com/2014/01/23/action-h1-energy-data-open-data-and-visualisation/>

4 Results

The key outcomes of engaging the municipalities are the development of:

- 1) a municipality ontology that can be used by all European municipalities to generate and publish Linked Open Energy Data;
- 2) a conceptual use cases integrating data from the three municipalities into a case of use documented in D4.3 (to be released at the end of the project).

4.1 An energy measurement vocabulary for municipalities

One of the event types the READY4SmartCities consortium organises are VoCamps where practical hand-on sessions allow knowledge exchange and team work. During a consortium meeting after the first project year it was decided to organise a dedicated VoCamp for European municipalities. Working together, municipality representatives were able to produce a common ontology to be used for transformation of municipal consumption energy data into Linked Open Data. From the datasets used as basis for the VoCamp, two were provided by Bristol and Leicester, with a Leicester representative attending the meeting as well.

The developed ontology (<http://smartcity.linkeddata.es/LD4SC/def/ontology#>) especially assists European municipalities during the generation process – the generation steps described in D4.1 can be considerably optimized for this stakeholder group due to the existence of a ready-to-be-used ontology.

Another important function of the VoCamp was to promote Linked Open Data as a goal adopted by the municipalities themselves. This was reached through ten municipality representatives from different regions coming together to develop their own ontology, a product with the flavour “from municipalities to municipalities”, expected to contribute to easier adoption of the LOD approach.

The URI of the ontology is <http://smartcity.linkeddata.es/LD4SC/def/ontology#>. Main represented classes are "Building", "Location", "Observation" and "Proeprty". The ontology is implemented in OWL (Web Ontology Language) and the primitives used are: classes, object properties, datatype properties, individuals, domain and ranges axioms, equivalent classes, subclass and subproperty axioms, and import as well as annotation properties. The ontology was developed in English and translated into nine different languages, namely: German (@de), Greek (@el), Spanish (@es), Finnish (@fi), French (@fr), Italian (@it), Portuguese (@pt), Dutch (@nl), and Serbian (@sr).

We plan to promote and present the ontology at further venues and opportunities, especially by the consortium partners who are experts in the field of ontology use, so that practitioners are aware of its existence and consider reusing it.

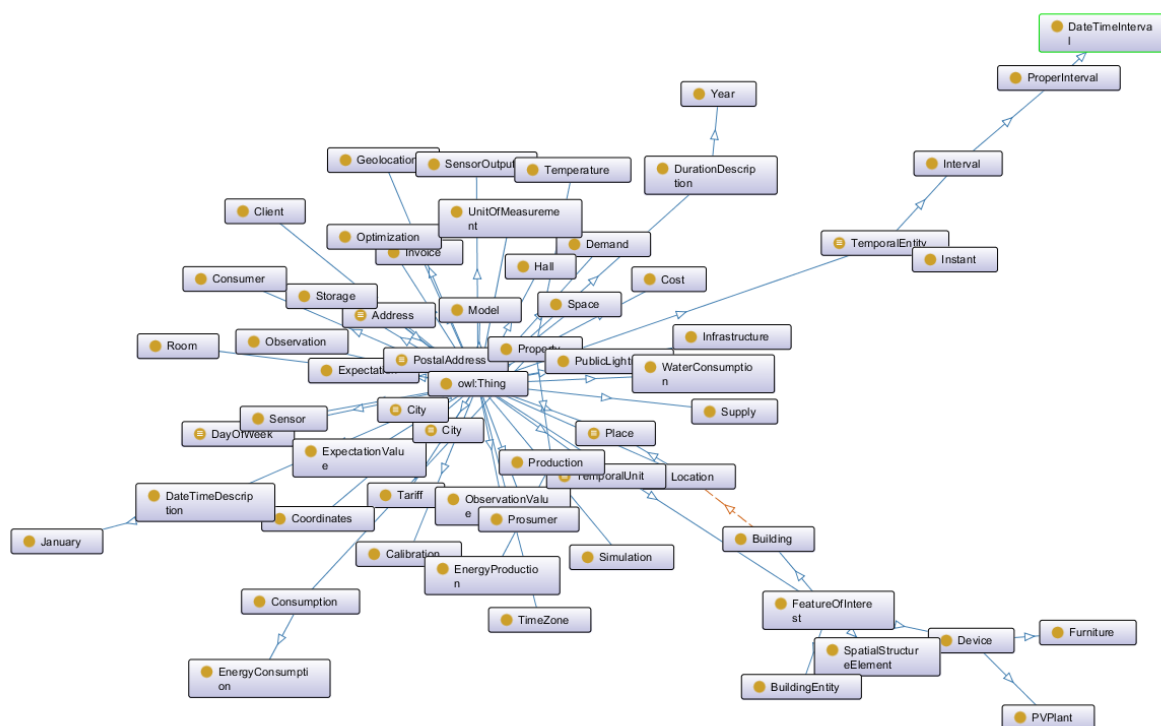

Figure 4. Energy measurement in municipalities vocabulary – class hierarchy

4.2 Use case development for European municipalities

During talks with Bristol, Leicester and Birmingham representatives, it became clear that real cases of use that promise benefits for citizens and other parties are required by municipalities for them to adopt new approaches which take time and understanding and ultimately require financial investment.

For this reason, as part of work package 4, it was decided to conceptualise a use case that showcases municipal consumption data. To this end, the municipalities of Bristol, Leicester and Birmingham provided consumption data from their public buildings (two libraries in Bristol, a library and two university buildings in Leicester, and a university building in Birmingham). All buildings were evaluated in the project SMARTSPACES, comparing energy consumption before applying an innovative energy management and decision support solution (before intervention), and after. As part of the use case, the data was made available as queryable Linked Open Data (<http://smarcity.linkeddata.es/spaces/sparql/>).

The use case is described in detail and can be found in 'D4.3 Requirements and guidelines for energy data exploitation'. Its goal is to enable users to compare consumption data of public buildings. The results can be used to identify especially energy efficient buildings or buildings performing poorly, and compare them (e.g. building type, intervention) with other municipalities. Further research may point to ways of improving the underperformers based on best practices in the champion buildings.

Though the use case is conceptual rather than an implemented product, it is provided to the municipalities along with all available project materials, encouraging them to implement and test a real-life example of linked municipal data.

Part B: Ontologies and Datasets for Energy Management Systems Interoperability v2

5 Collection of ontologies and datasets

During the second year of the project, the partners involved in the ontologies and dataset collection have followed the approach set in the first year. Therefore, we refer the reader to D2.2 for further details about the project partner involvement. D2.2 also contains detailed information about the different ways used by partners to collect ontologies and datasets, while in the following only updates are included.

- Stakeholder involvement
- Review literature for ontology seeking
- Analysis of Standardization and Institutional Bodies
- Lookup Resource Catalogues

During this second year the ontology catalogue has been presented in the “Building Knowledge Workshop” (Graz, 16th September 2014) and the “5th Workshop on EeB Data Models” (Vienna, 18th September 2014). In both events, a second version of the catalogue was presented including webpages for each ontology or dataset containing details for it and evaluation features for the ontologies. This feature together with other improvement is presented in next section.

5.1 Stakeholder involvement

An **online survey** was set up and launched in March 2014 to enable capturing contributions by the stakeholder community. The idea of the survey is to provide an easy way for stakeholders to take part in the project activities, while also offering the possibility for more experienced stakeholders to provide detailed information. This has been realised by creating two versions of the survey. The first asks stakeholders to only provide the location (URL) of the resource they are aware of, and the follow up research of the resource is done by the project partners. A second survey provides an interface with all information necessary to record an ontology or dataset. If filled by a stakeholder, this information is saved in the database and only needs to be checked by the curator of this database (for the ontology catalogue, this is UPM, Empirica is the curator for the gathered datasets). The survey links will remain active throughout the project lifetime in order to provide a way for new ontologies and datasets to be included. The following links are used for this purpose:

- <http://survey.ready4smartcities.eu/index.php/638667/> - short ontology survey
- <https://docs.google.com/forms/d/1kTrNUKRnAIN5bBnOwTzQjWwQLinKFQcW4EqXDOYbFsQ/viewform> - long ontology survey
- <http://survey.ready4smartcities.eu/index.php/162877/> - short dataset survey
- https://docs.google.com/forms/d/1EUJSLPLpVHmBaUy2qI76LjE_UPkqPaSW9J1nDruKS0U/viewform - long dataset survey

The target audience for the online survey consisted primarily of stakeholders having access or connected somehow to energy-related data. Such stakeholders were reached through various channels as listed below:

- Mailing list of relevant partners/projects – each partner from the READY4SmartCities consortium shared a number of their partners from other projects based on their background and their relevance to the survey. The mailing list created counted more than 1000 people and was used to introduce the R4SC project and to invite interested people to fill in the survey.

- eeSemantics wiki – CERTH partner is responsible for the maintenance of the eeSemantics wiki, forum and document library on Semantic Interoperability of Energy Efficiency ICT Tools for eeBuildings and beyond and therefore has access to the whole member list of relevant stakeholders (counting more than 500 members). An introduction to the R4SC project and concept was sent, followed by an invitation to participate in the survey, by both a post in the Forum and an email sent to the mailing list.
- READY4SmartCities Portal – the survey was made available and promoted on the R4SC website <http://www.ready4smartcities.eu/> and was posted on the website's newsletter.
- Social Networks – the questionnaire invitation was published through the R4SC project's social networks, namely LinkedIn and Twitter, early established in the project.
- VoCamp Participants – during the VoCamps in Germany and Finland, participants with high relevance to energy-related data were approached and were requested to dedicate some time to answer the survey.

5.2 Review literature for ontology seeking

Some of the ontologies included in the READY4SmartCities catalogue¹⁵ have been gathered through the revision of related literature. It is important to mention that the search has been focused on ontologies or vocabularies already implemented in an ontology language, such as RDF and OWL. Thus, when the ontology was only a non-implemented model, such ontology was not taken into account.

The general ontology collection process was:

- UPM read each corresponding document and search for references to ontologies
- When a reference to a relevant ontology is found in the text, two different situations can occur:
 - Such a reference directly leads to a link in which the ontology (implemented in an ontology language) is available. In this case, UPM downloaded the ontology and reviewed the ontology code. After that, UPM acted as catalogue populator by means of providing ontology metadata through the online form.
 - Such a reference is just a textual reference (normally the ontology name). In this case, UPM performed a broad search in the Internet looking for documents about such ontology. When documents were found, UPM started again the general process. On the contrary, UPM had to contact people involved in the ontology development and/or related with such an ontology. UPM directly contacted paper authors, deliverable contributors and/or project coordinators in order to ask for (a) other relevant papers and/or documents in which the ontology is described, (b) information about the ontology files (e.g., if exists, the site in which the ontology is available for downloading), and (c) any other relevant data. However, UPM discovered cases in which it were not possible to contact people (document authors, project coordinators, etc.) involved in the ontology development or related to the ontology building.

As a result of the contacts conducted, the possible responses obtained were:

- Confirmation that the ontology is not available on-line, but the ontology file was sent via email
- Confirmation that there is no ontology implemented
- Confirmation that the ontology is not public
- Information about the current status of the ontology development (e.g., the ontology implementation is in progress, our plans includes the development of an ontology).
- No reply was obtained at the moment of writing this document

The revision of related literature included the following sources:

- *eeSemantics wiki*¹⁶. UPM has reviewed pages in the wiki looking for ontologies related to the energy efficiency domain. In particular, pages on the 'Examples and Implementations' and 'eeBuilding Data Models'

¹⁵ <http://smartcity.linkeddata.es/>

¹⁶ <https://webgate.ec.europa.eu/fpfis/wikis/display/eeSemantics/Home>

sections were inspected. In some cases, it was also needed to search for related papers and/or documents. As a result of reviewing this source, five ontologies were included in the catalogue.

- *eeBuilding Data Models workshop proceedings*. Proceedings of this series of workshops were reviewed in order to find related ontologies. The ontologies found in such proceedings were already included in the catalogue while checking other sources.
- *ETSI Smart Appliances workshop report*. The document, D-S1 Interim Study Report, presents a list of existing semantic assets and use case assets, describes their semantic coverage, and proposes an initial semantic mapping. In some cases, it was also needed to search for related papers and/or documents. As a result of the revision of this report one ontology has been included in the catalogue.
- *European project production*. Documents produced within 70 energy-related projects (such as STREAMER, SESAME-S, S4EEB, HYDRA, and SEEMPUBS) have been reviewed. As an outcome of this literature checking, five ontologies were included in the catalogue by UPM acting as a catalogue populator.
- *Other related research literature*. Papers in the area of energy efficiency have been reviewed. UPM included in the catalogue eight ontologies (e.g., DogOnt, ontologies developed in the context of ThinkHome project) found during the inspection of this source.

Finally, it is also important to mention that UPM has checked READY4SmartCities Deliverable D4.1 in order to include in the catalogue those ontologies mentioned in the described guidelines. In addition, UPM considered useful to have ontologies in the geographical domain, thus literature in such an area was reviewed. The effect of this revision was the inclusion of two ontologies (OGC GeoSPARQL and WGS84 Geo Positioning).

5.3 Review literature for datasets

The datasets included in the READY4SmartCities catalogue have been gathered mainly through desk research, which, however, relates also to surveying related literature sources. It is important to mention that the search has been focused on datasets that are linked and open, i.e. the data should be in RDF. This meant that other datasets which weren't linked or open were not added to the catalogue, they were, however, taken into account specifically for the gap analysis (see section 9.1).

Relevant sources for the datasets came from the expertise of the involved project partners, the survey entries, and suggestions from experts and stakeholders contacted by the consortium as part of WP1 activities. Some of the portals that were pointed as possible sources of information include:

- **Reegle**¹⁷: the gateway has already established itself as a popular information portal in the fields of renewable energy and energy efficiency. It offers all of its data under W3C standards, i.e. it is open and Linked Data in a non-proprietary format (RDF).
- **OpenEI**: a collaborative knowledge-sharing platform with free and open access to energy-related data, models, tools, and information. OpenEI features over 55,000 content pages, more than 600 downloadable data sets, regional gateways on a variety of energy-related topics, and numerous online tools.
- **Datahub**: this powerful data management platform covering a wide range of topics. It offers data collections, some of which are linked and open.

The dataset collection process is similar to the one used to collect ontologies. An identified dataset that meets the requirements of Linked Open Data is added to the catalogue by the dataset curator EMP (only metadata) through the corresponding online form.

¹⁷ <http://www.reegle.info/>

5.4 Analysis of Standardization and Institutional Bodies

In general, standardization and institutional bodies are a valuable source of information when it comes to identify agreements for information exchange and reuse of data. Seamless exchange of digital data has been an issue from the very beginning of computer based work and a lot of efforts have already been made to reach consensus between different parties about how to organize and structure shared data. The Open Linked Data Approach based on general web standards like URI, XML, RDF, OWL and SPARQL is a relatively new approach compared to other technologies like SQL, IDEF or STEP-EXPRESS. The main use case of (Open) Linked Data is to publish and interlink pieces of information and thus differs from current exchange and integration approaches. Meanwhile, after several years of research, standardization bodies took notice of this new technology and its potential benefits. While there are still ongoing discussions about use cases and how to position OLD to existing developments, it became clear that both approaches can benefit from each other. On one side there are rich vocabularies, model schemata and business logic developed in many years of standardization work and on the other side there is a new technology to support the web of data with all promised advantages. While our search for ontologies and open datasets published by standardization bodies was not really successful we realized that there are ongoing discussions and preparation work for further standardisation. A short summary of the current situation as well as activities of R4SC towards support actions is given below.

W3C

W3C is seen as the most relevant standardization body for OWL-based ontologies. The partner UPM is active in working groups related to the standardization of different technologies in the W3C. Different ontologies and vocabularies developed in the W3C and widely used were included in the catalogue for representing generic concepts (e.g., time, organizations) and some specific ones (e.g., sensor networks, statistical data). More domain specific W3C standards are currently developed or discussed for instance with support from OGC (Spatial Data on the Web Working Group)¹⁸ or AEC researches (Linked Building Data Community Group)¹⁹.

ETSI

From summer 2013, the European Commission has the intention to launch a standardization exercise at ETSI to propose a high-level model (an ontology) for smart appliances, as an ETSI standard. The first step consists in a pre-normative study that will be done by the Dutch TNO. This project is called "Study on Semantic Assets for Smart Appliances Interoperability" and consists in defining/ identifying a common vocabulary for appliances product information, commands, signals and in a second step agrees on an abstract architecture compatible with the current machine-to-machine (M2M) standards. The outcomes of this study is highly relevant for our project and already ontologies coming from 17 relevant initiatives or project have been translated into Turtle language and are available for download (<https://sites.google.com/site/smartappliancesproject/ontologies>).

UPM and other project partners participated in the DG CONNECT & ETSI Workshop on Smart M2M Appliances, held in Brussels on 27-28 May 2014. In that workshop, a study on available semantics assets for the interoperability of smart appliances was presented. The document, D-S1 Interim Study Report, presents a list of existing semantic assets and use case assets, describes their semantic coverage, and proposes an initial semantic mapping. We took into account the ontologies described in that document and, in some cases, we also needed to search for related papers and/or documents

AENOR

¹⁸ <http://www.w3.org/2014/05/geo-charter>

¹⁹ <http://www.w3.org/community/lbd/>

UPM is member of the AENOR (the Spanish standardization body) Technical Committee for Smart Cities (CTN 178). For this version of the catalogue a current working draft of a standard on open data for smart cities was analysed in order to search for relevant ontologies.

buildingSMART

buildingSMART is an international non-profit organization that develops open standards for the AEC and FM industry. Since nearly 20 years buildingSMART is pushing the BIM technology. Meanwhile its open IFC standard is supported by all major CAD software tools. AEC3 is very active in this organization and started to facilitate discussions about an ifcOWL standard²⁰ as a baseline for further developments. The Joint workshop on Linked Data in Architecture and Construction (2nd LDAC Workshop & 6th eeSemantics VoCamp, Espoo/Finland, 26-27 May 2014), co-organised and supported by the Ready4SmartCities project, brought together ontology and AEC experts and was used to discuss two main topics: (1) use case scenarios for linked building data and (2) requirements for a unified ifcOWL representation. Also, it was decided to give feedback to the buildingSMART organization and to facilitate a buildingSMART working group that puts this topic on its agenda.

ISO

ISO is a well-known international standardization body for a broad spectrum of engineering applications. The partner AEC3 is involved in standardization work in the building and construction sector, in particular in publishing the IFC model as an ISO standard (ISO 16739). OWL ontologies are not yet a topic, but there are similarities to XML schema-based definitions. Within the STEP family of standards (ISO 10303) the EXPRESS language as used for the IFC specification is defined. For support of XML schema a mapping approach is used that includes a standard mapping configuration that can also be adapted to specific purposes. This approach fits to proposals that have been made by several researchers to transfer the EXPRESS-based IFC model to an OWL representation. These proposals could be a baseline for a general mapping approach that then would allow to map other EXPRESS-based standards to a W3C conformant representation.

Other Standardisation and Institutional Bodies

There are a couple of efforts towards the aim of Ready 4 Smart Cities, e.g. the Energy Performance Buildings Directive from CEN or the draft about a Facility Smart Grid Information Model from ASHRAE. Also, there are a couple of data exchange standards that are relevant in context of smart cities use cases. However, they typically do not make use of the Open Linked Data approach or underlying technologies so that we decided to ignore such efforts for our catalogue or further discussions.

5.5 Lookup Resource Catalogues

There are several ontology search engines that UPM has analysed for identifying ontologies that are relevant to READY4SmartCities: Watson²¹, Swoogle²², and Linked Open Vocabularies (LOV)²³.

The main resource used during the ontology catalogue has been LOV as it includes information about creators, maintainers and publishers that are not always included in the ontology encoding nor the documentation

²⁰ As buildingSMART already publishes a mature, object-oriented data model the strategy from researchers has been to work on mapping proposals from the EXPRESS language to a proper OWL representation of IFC. Depending on use case scenarios and used ontology toolsets there are different flavours for such mapping definitions. Thus, while all available ifcOWL representations are derived from the original IFC specification there is not yet a common agreement within this community which of those should be preferred or the “standard” representation.

²¹ <http://watson.kmi.open.ac.uk/>

²² <http://swoogle.umbc.edu/>

²³ <http://lov.okfn.org/dataset/lov/>



associated, if any. As LOV does not cover all the ontologies gathered during this collection process this approach does not ensure to find such metadata for all possible cases.

Another catalogue that UPM analysed was the Collaborative platform Joinup²⁴. This platform offers several services that aim to help e-Government professionals share their experience regarding interoperability solutions with each other. Although the vocabularies are not directly related to the energy efficiency or the smart cities domain, UPM considered useful to review ontologies and vocabularies recommended in such a platform. The effect of this inspection was the inclusion of the Registered Organization Vocabulary in the ontology catalogue.

²⁴ <https://joinup.ec.europa.eu/>

6 Recording of ontologies and datasets

The following section present improvement in the ontology catalogue and dataset catalogue respectively in comparison to the version presented in the previous version of this deliverable. Beside such improvement, there are also common features affecting both the ontology and dataset catalogues, namely:

- A SPARQL endpoint containing data in RDF for both catalogues has been made available at <http://smartcity.linkeddata.es/sparql>.
- A dcat (data catalogue vocabulary)²⁵ description containing metadata information about both catalogue has been produced and made available at <http://smartcity.linkeddata.es/metadata/dcatSmartcities.ttl>
- Filtering by domain feature has been added to the index pages for both catalogues.
- Description pages for ontologies and datasets

6.1 Ontology catalogue

This section shows the updates on the ontology catalogue implementation. For the overview and catalogue generation we refer the reader to the previous version of this deliverable. The catalogue of ontologies about smart cities, energy and other related fields can be accessed through a web application available at <http://smartcity.linkeddata.es/ontologies/>.

As in the previous version and as it is shown in Figure 5, the index catalogue allows visualizing metadata about the listed ontologies. For each ontology, the metadata are shown in the columns: “Syntax”, “Domain”, and “Natural Language”. The values shown in each cell of the table contain different information both represented by text and by colour; for ontology metadata, colours have the following meaning: “plain information” for blue and “unknown” for grey. Furthermore, in addition to the colour, each cell contains detailed information when available.

Apart from ontology metadata, the catalogue presents in the first three columns the quality indicators for the ontologies defined in [Garcia-Castro et al, 2014]: “Online Availability”, “Open License”, and “Ontology Language”. For the quality indicators, colours have the following meaning: “success” for green, “warning” for orange, “danger” for red, and “unknown” for grey.

As in the first version of the catalogue, the values of the “Open License” and “Ontology Language” indicators are taken from the ontology metadata and the evaluation results are stated using colour. For example, in the column “Open License” we can see that the ontologies “Units of Measure (OM)” and “The W3C Organization Ontology” are both published under an open license as the colour of the cell is green, while detailed information about the licenses is also provided. More precisely, these licenses are “CC-BY 3.0” (Creative Commons Attribution 3.0 Unported) and “W3C” (W3C Software Notice and License) respectively.

The “Online Availability” indicator represents whether the ontology is available in the Web in RDF and in HTML format. The evaluation of this indicator is performed on execution time when the catalogue is generated, that is, it is updated every time the catalogue is rebuilt.

²⁵ <http://www.w3.org/TR/vocab-dcat/>

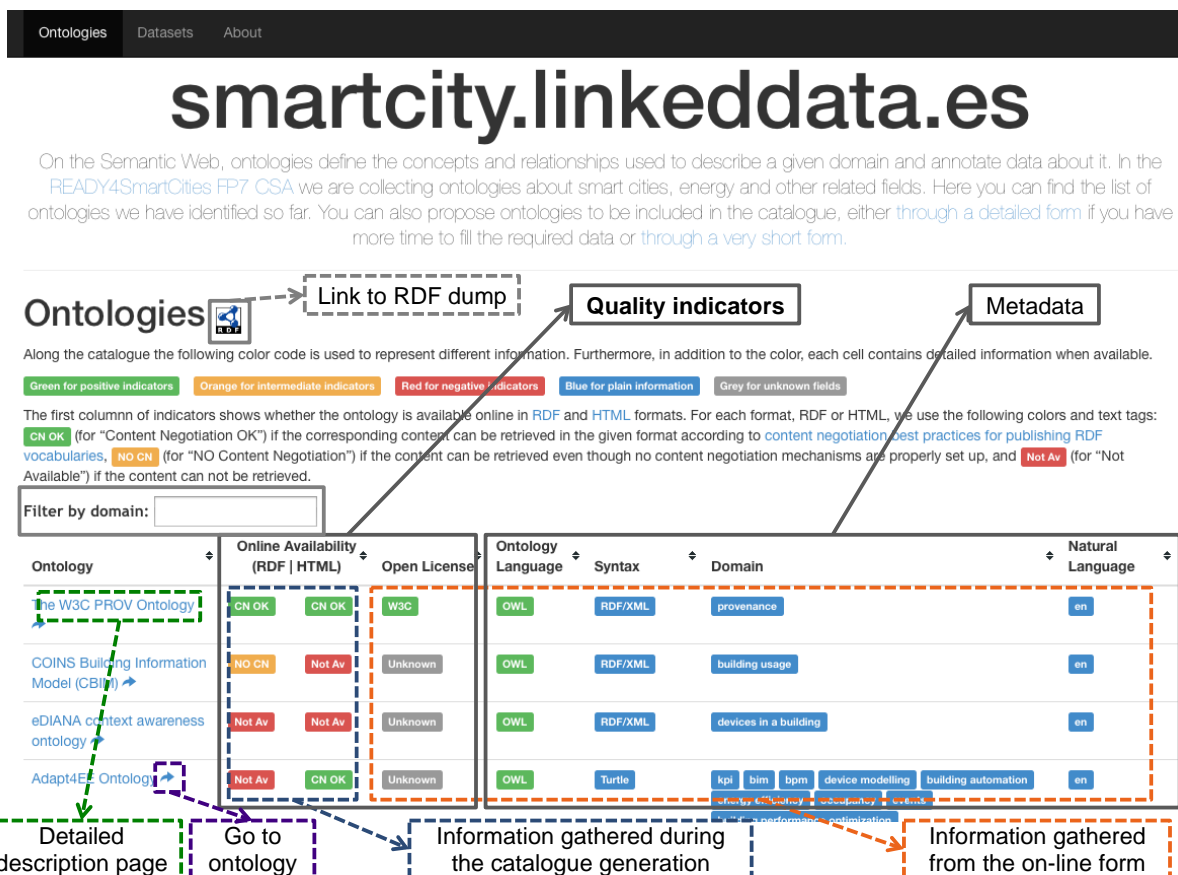

Figure 5. Screenshot of the ontology catalogue home page

In this second year some improvements have been implemented in the catalogue. As Figure 5 shows, the ontology column has been extended so that the link in the ontology title goes to a webpage describing each ontology, while the link arrow near to the name redirects to the ontology itself.

Figure 6 shows an example of a webpage describing a particular ontology. These pages show detailed information about the ontology gathered in the submission form like title, URI, description, languages, ontology languages and formats, issued and modified date, version and license. When the ontology is available and accessible via its URI it is analysed by OOPS! (Ontology Pitfall Scanner!²⁶, [Poveda-Villalón et al., 2012]) and the evaluation results are provided in the same webpage as shown in Figure 6. Such evaluation results consist on a list of detected pitfalls (situations that represent an error in ontologies or might lead to errors). For each detected pitfall it shows its title, how many times it appears, how important is the pitfall (minor, important or critical), a description of what the pitfall consists on and the list of elements affected.

²⁶ <http://oops.linkeddata.es>

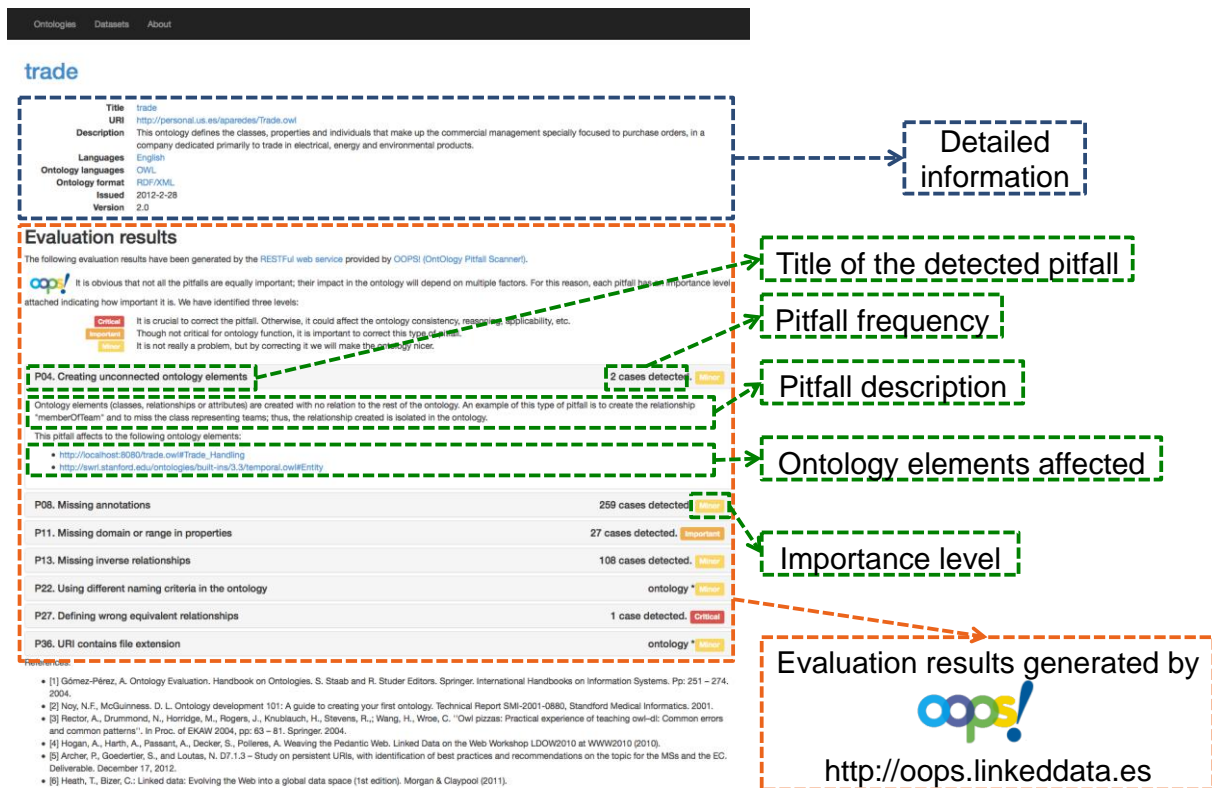

Figure 6. Screenshot of ontology description page example

6.2 Dataset catalogue

This section shows the updates on the dataset catalogue implementation. For the overview and catalogue generation we refer the reader to the previous version of this deliverable. The catalogue of datasets about smart cities, energy and other related fields can be accessed through a web application available at <http://smartcity.linkeddata.es/datasets/>.

As in the previous version and as it is shown in Figure 7, the catalogue allows visualizing metadata about the listed datasets. For each dataset, the metadata are shown in the columns. More precisely the columns “Digital form”, “Publicly available”, “Free of charge”, “Available online”, “Machine readable”, “Available in bulk”, “Open License” and “Up to date”, represent the considered quality indicators as defined in [Garcia-Castro et al, 2014] while the columns “Domain” and “Natural language” provide general information about the dataset. The values shown in each cell of the table contain different information both represented by text and by colour; for ontology metadata, colours have the following meaning: “plain information” for blue and “unknown” for grey. Furthermore, in addition to the colour, each cell contains detailed information when available.

In this second year some improvements have been implemented in the catalogue. As Figure 7 shows, the dataset column has been extended so that the link in the dataset title goes to a webpage describing each dataset, while the link arrow near to the name redirects to the dataset itself.

Figure 6 shows an example of a webpage describing a particular dataset. These pages show detailed information about the dataset gathered in the submission form like its title, description, the domains addressed in the dataset, versioning information, Creation date and last update, contact person, publisher, license, format, language, update frequency, whether it is available online, publicly available, free of charge, available in a machine readable format and available via bulk. Finally, at the bottom of the page, the ontologies used by the dataset are listed. In

case the ontology is already included in the catalogue, a link to its specific page is provided following the ontology name with the label “see in the catalogue”.

smartcity.linkeddata.es

In the [READY4SmartCities FP7 CSA](#) we are collecting datasets about smart cities and energy efficiency. Here you can find the list of datasets we have identified so far. You can also propose datasets to be included in the catalogue, either [through a detailed form](#) if you have more time to fill the required data or [through a very short form](#).

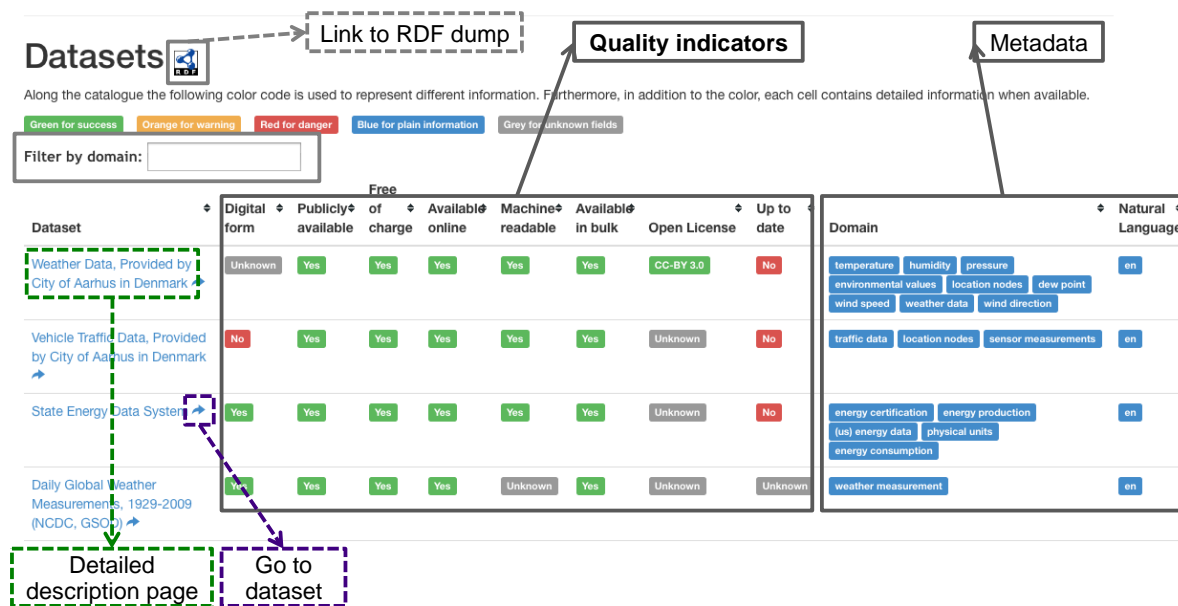

Annotations:

- Link to RDF dump:** Points to the 'Link to RDF dump' icon in the 'Weather Data, Provided by City of Aarhus in Denmark' row.
- Quality indicators:** Points to the 'Quality indicators' box above the table.
- Metadata:** Points to the 'Domain' section on the right side of the page.
- Detailed description page:** Points to the 'Detailed description page' button below the 'Weather Data' row.
- Go to dataset:** Points to the 'Go to dataset' button below the 'State Energy Data System' row.

Dataset	Digital form	Publicly available	of charge	Available online	Machines readable	Availabi in bulk	Open License	Up to date	Domain	Natural Language
Weather Data, Provided by City of Aarhus in Denmark	Unknown	Yes	Yes	Yes	Yes	Yes	CC-BY 3.0	No	temperature, humidity, pressure, environmental values, location nodes, dew point, wind speed, weather data, wind direction	en
Vehicle Traffic Data, Provided by City of Aarhus in Denmark	No	Yes	Yes	Yes	Yes	Yes	Unknown	No	traffic data, location nodes, sensor measurements	en
State Energy Data System	Yes	Yes	Yes	Yes	Yes	Yes	Unknown	No	energy certification, energy production, (us) energy data, physical units, energy consumption	en
Daily Global Weather Measurements, 1929-2009 (NCDC, GSO)	Yes	Yes	Yes	Yes	Unknown	Yes	Unknown	Unknown	weather measurement	en

Figure 7. Screenshot of the dataset catalogue home page

Weather Data, Provided by City of Aarhus in Denmark

Title	Weather Data, Provided by City of Aarhus in Denmark
Description	A collection of datasets of weather observations from the city of Aarhus. Collected measurements from February 2014 - June 2014 and August 2014 - September 2014. Weather data values: Dew point in degrees Celsius, Humidity (percentage), Pressure in mBar, Temperature in degrees Celsius, Wind direction in degrees, Wind speed in kilometers per hour (kph)
Domain	weather data , environmental values , Dew point , Humidity , Pressure , Temperature , Wind direction , Wind speed , location nodes
Version	1.0
Creation date	30/09/2014
Last update	30/09/2014
Contact person	Daniel Puschmann Centre for Communication Systems Research (CCSR) University of Surrey , UK email: d.puschmann@surrey.ac.uk,
Publisher	CityPulse EU FP7 Project
License	CC-BY Creative Commons Attribution Unported (Open) http://creativecommons.org/licenses/by/4.0/
Format	Turtle
Language	en
Update frequency	Historical values
Available online	Yes
Publicly available	Yes
Free of charge	Yes
Machine readable for...	Yes
Bulk available	Yes
Ontologies used	http://www.insight-centre.org/citytraffic# , http://purl.oclc.org/NET/ssnx/ssn# (see in the catalogue) , http://purl.org/NET/provenance.owl# , http://www.w3.org/1999/02/22-rdf-syntax-ns# , http://www.w3.org/2000/01/rdf-schema# , http://iot.ee.surrey.ac.uk/citypulse/resources/ontologies/sao.ttl , http://purl.org/NET/c4dm/timeline.owl# (see in the catalogue) , http://www.w3.org/XML/1998/namespace , http://www.w3.org/2001/XMLSchema# , http://purl.oclc.org/NET/muo/ucum/ , http://purl.oclc.org/NET/muo/citypulse/unit/velocity

Detailed information

Links to ontologies

Figure 8 Screenshot of dataset description page example

6.3 Alignments catalogue

The alignment catalogue is implemented as an alignment server sharing alignments on the web. Below, we describe briefly the architecture of the alignment server and the methodology used for generating the alignments it contains

6.3.1 Overview of the Alignment server

The Alignment server can supply alignments for people to inspect and for systems to reuse. More than a simple catalogue, it offers the opportunity to generate, organise and manipulate alignments online.

The goal of the Alignment server is that different actors can share available alignments and methods for finding alignments. Such a server enables to match ontologies, store the resulting alignment, store manually provided alignments, extract merger, transformer, mediators from those alignments.

The Alignment server is built around the Alignment API. It thus provides access to all the features of this API. The server architecture is made of three layers:

- **A storage system** providing persistent storage and retrieval of alignments. It implements only basic storage and runtime memory caching functions. The storage is made through a DBMS interface and can be replaced by any database management system as soon as it is supported by jdbc.
- **A protocol manager** which handles the server protocol. It accepts the queries from plug-in interfaces and uses the server resources for answering them. It uses the storage system for caching results.

- **Protocol plugs-in** which accept incoming queries in a particular communication system and invoke the protocol manager in order to satisfy them. These plugs-in are ideally stateless and only translator for the external queries.

This infrastructure is able to store and retrieve alignments as well as providing them on the fly. We call it an infrastructure because it will be shared by the applications using ontologies on the semantic web. However, it may be seen as a directory or a service by web services, as an agent by agents, as a library in ambient computing applications, etc.

Services that are provided by the Alignment server are:

- storing alignments, whether they are provided by automatic means or by hand;
- storing annotations in order for the clients to evaluate alignments and to decide to use one of them or to start from it (this starts with the information about the matching algorithms, the justifications for correspondences that can be used in agent argumentation, as well as properties of the alignment);
- producing alignments on the fly through various algorithms that can be extended and parametrised;
- manipulating alignments by inverting them, applying thresholds;
- generating knowledge processors such as mediators, transformations, translators, rules as well as to process these processors if necessary;
- finding similar ontologies and contacting other such services in order to ask them for operations that the current service cannot provide by itself.

Alignment server commands

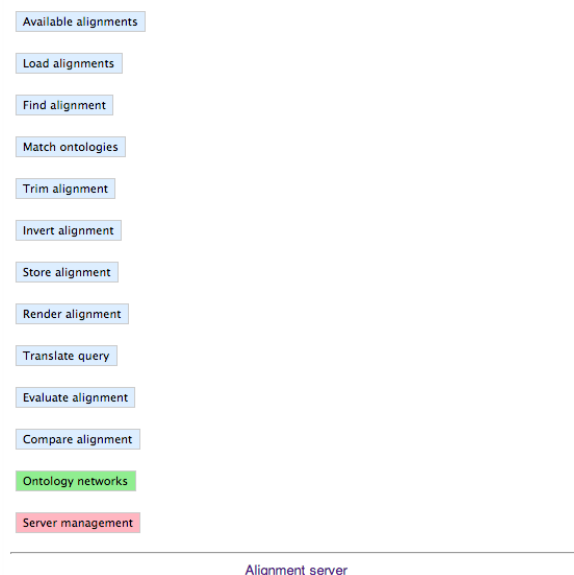

Figure 9. Menu of the services provided through the Alignment server

The menu of these services through the HTML plug-in is seen on Figure 9. For Ready4SmartCities, we introduced in the server the notion of ontology network which group together a set of ontologies and a set of alignments for better visibility.

The server is accessible from the ontology catalogue (but currently not the other way around because the ontologies refer only to their actual URI).

This section serves as a documentation for the connection between the ontology catalogue and the Alignment server. The main point would be that it is possible to link these. This has to be performed through web services call invocation. We describe here the REST interface, however a SOAP interface is also available.

There are two main ways which can be used to connect the Ontology catalogue to the Alignment server.

The ontology catalogue provides for each ontology access to the alignments mentioning it in the Alignment server. This is achieved by generating a URL such as:

<http://al4sc.inrialpes.fr/html/listalignments?uri1=http%3A%2F%2Fwww.geonames.org%2Fontology&uri2=all>

This redirects to the list of all alignments involving the geoname ontology as shown in the following figure:

Available alignments

Onto1:

Onto2:

- <http://al4sc.inrialpes.fr/alid/1401809057321/6445>
- <http://al4sc.inrialpes.fr/alid/1401809057318/9838>
- <http://al4sc.inrialpes.fr/alid/1401809057317/146>
- <http://al4sc.inrialpes.fr/alid/1401809057313/4148>
- <http://al4sc.inrialpes.fr/alid/1401809057316/1045>
- <http://al4sc.inrialpes.fr/alid/1401809057319/513>
- <http://al4sc.inrialpes.fr/alid/1401809057320/2329>
- <http://al4sc.inrialpes.fr/alid/1401809057311/3806>
- <http://al4sc.inrialpes.fr/alid/1401809057314/7657>
- <http://al4sc.inrialpes.fr/alid/1401809057317/2124>
- <http://al4sc.inrialpes.fr/alid/1401809057313/4392>
- <http://al4sc.inrialpes.fr/alid/1401809057318/3472>
- <http://al4sc.inrialpes.fr/alid/1401809057318/2473>
- <http://al4sc.inrialpes.fr/alid/1401809057320/6662>
- <http://al4sc.inrialpes.fr/alid/1401809057317/4944>
- <http://al4sc.inrialpes.fr/alid/1401809057313/5697>

[Alignment server](#)

Figure 10. List of alignments involving the geoname ontology

In counterpart, each alignment description features two annotations (cat1 and cat2) which refer to the URLs of each ontology in the catalogue.

6.3.2 Methodology of alignment generation

The generation of the network of alignments for the Alignment server has been spread on the two years of the project. In 2014, a network with a core of 10 ontologies has been generated. In 2015, a network involving 42 ontologies has been generated filling largely the gap of missing alignments.

Figure 11 describes the adopted methodology spanning the two years.

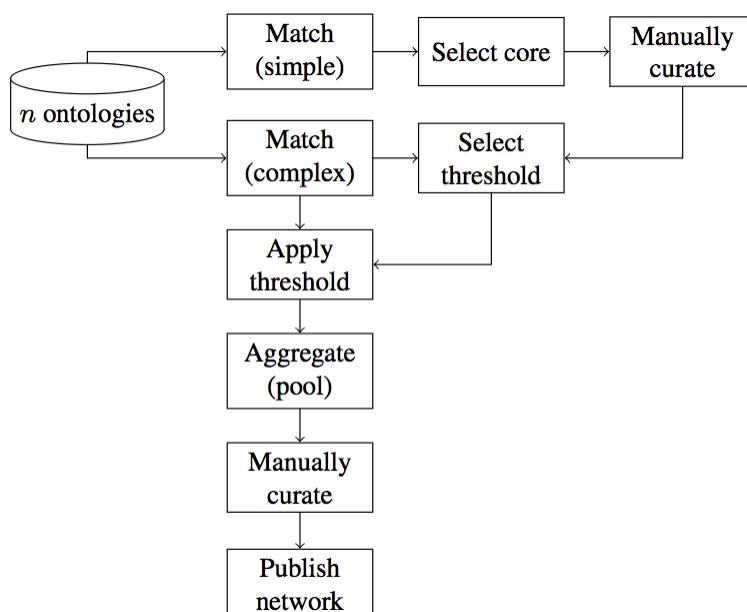

Figure 11. Workflow of the alignment generation and curation process

The methodology has taken the following steps:

- match all (simple): The ontology are matched on the basis of string equivalence.
- select core: A subset of ontologies is selected by taking the most connected ontologies.
- match core (average): The core ontologies are matched with basic string-based matchers (SMOA and EDNA).
- select threshold: A threshold on the alignments so generated is chosen so they generate only 33% additional correspondences in addition to the simple matchers.
- apply threshold: The selected threshold is applied to the alignments and they are merged.
- manually curate: The resulting alignments are manually curated (this was performed in 2014).
- match (complex): The ontologies are matched with a larger panel of matching system, including Aroma and LogMap.
- aggregate: For each pair of ontologies, all the alignments between this pair are aggregated in a single alignment containing all their correspondences with a confidence corresponding to the proportion of matchers which have found it.
- manually curate: The whole network is manually curated by using systematic confidence levels
- publish network: The network is published on the Alignment server. This results in alignments generated by the process of Figure 12.

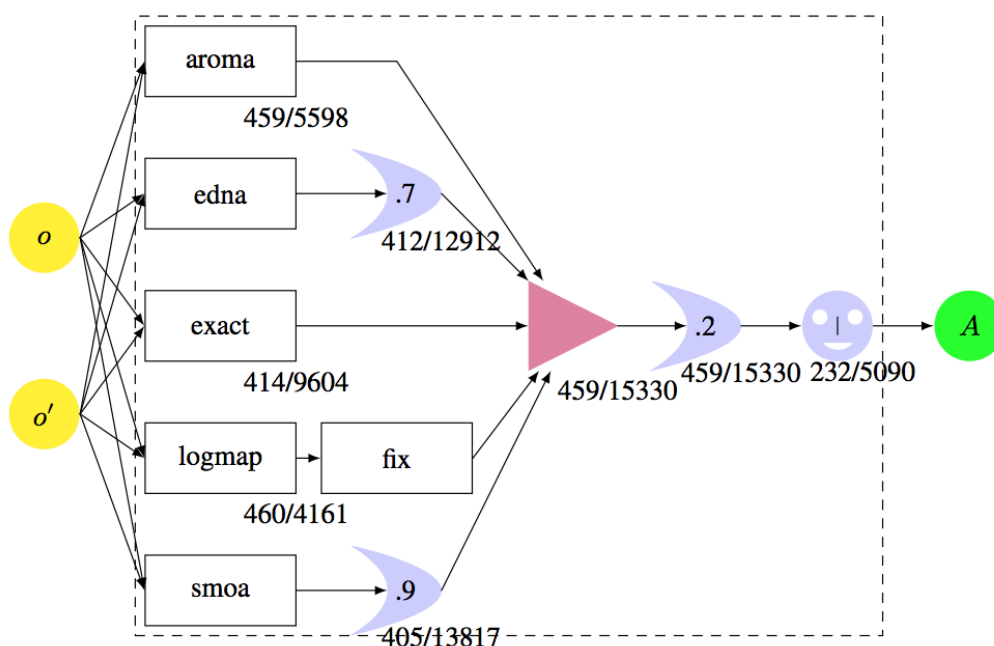

Figure 12. Process which actually led to the ontologies between alignments in the style of [Euzenat and Shvaiko, 2013].

The curation process has been rationalised by standardising the confidence measures associated with the correspondence. We reproduce below the table, provided to the curator, giving the semantics of confidence measures:

confidence	explanation
1.	Most certainly correct correspondence
.8	Certainly correct correspondence, but there may be some subtle difference
.7	Likely correct correspondence
.6	To check, with some chance to be correct
.5	To check
.4	To check, but not surprised if incorrect
.2	Unlikely correspondence, but who knows
.0	Most certainly incorrect correspondence (such correspondences are discarded) .

6.4 Overview of ontologies and datasets gathered during the first and second project years

6.4.1 Ontologies, vocabularies and standards

General overview of the Ontology Catalogue

- At the moment of writing this deliverable, the Ready4SmartCities Ontology Catalogue contained **70 ontologies**.
- UPM analysed these ontologies in order to provide a general overview of the ontology languages and format used, the natural languages in which ontologies are expressed, and the licenses attached to these ontologies.
- INRIA performed a content analysis covering other relevant aspects

The most common ontology language in the Ready4SmartCities Catalogue is **OWL**, followed by RDF-S. 65 ontologies are implemented in OWL, while only 3 ontologies are also coded in RDF-S, finally 1 ontology is coded only in RDF-S and 1 ontology is represented in SKOS. The distribution of ontology languages in the catalogue is shown in Figure 13. It is worth mentioning that five ontologies are in more than one ontology language. These ontologies are Timeline Ontology, Data Cube and Stream Annotation Ontology.

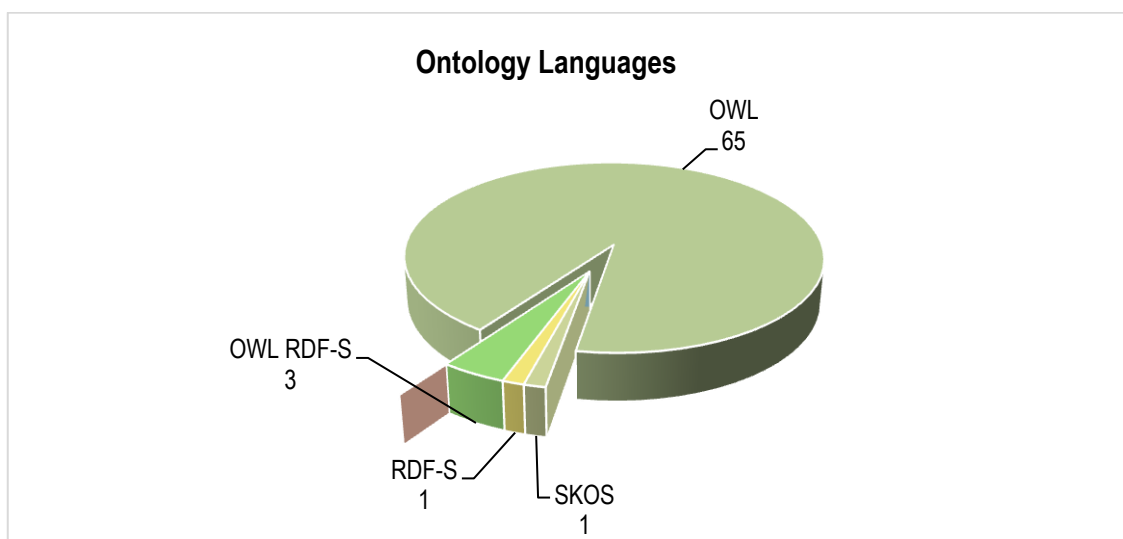

Figure 13. Ontology languages distribution

Regarding the ontology syntaxes, **RDF/XML** is the most usual one followed by Turtle. 51 ontologies are written using the RDF/XML syntax among other formats, while 20 are using the Turtle syntax within their serializations. As in the case of ontology languages, there are 8 ontologies in the catalogue provided with more than one format. These ontologies are Km4city, Units of Measure (OM), Measurement Ontology, The W3C Organization Ontology, IFC2X3 - University of Ghent, Places Ontology, Registered Organization Vocabulary, Stream Annotation Ontology - SAO. It is important to mention that for 3 ontologies the ontology syntax is not known. The distribution of ontology formats in the catalogue is shown in Figure 14.

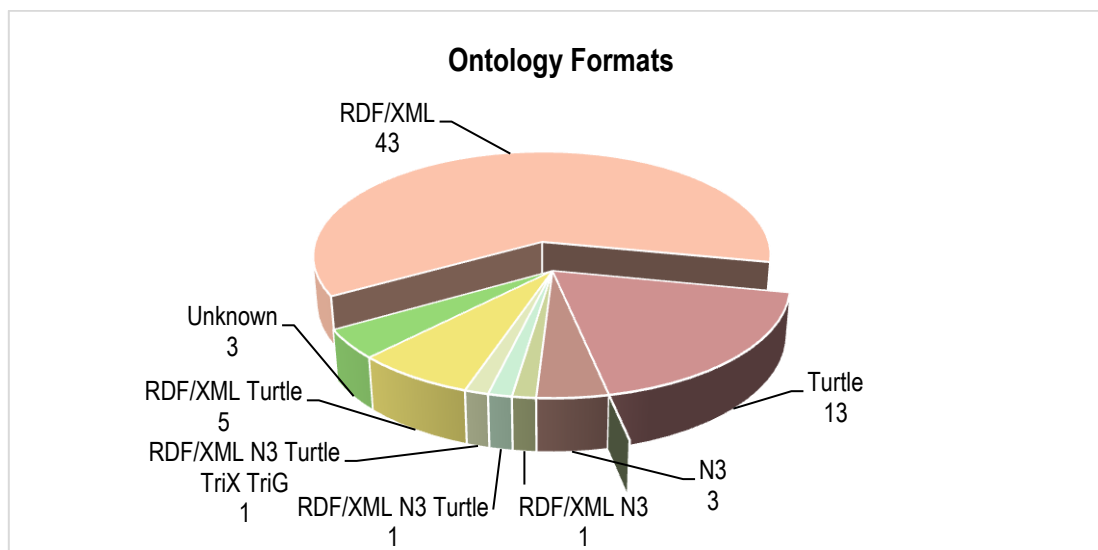

Figure 14. Ontology formats distribution

With respect to the natural language used for naming ontology elements, the most common one is **English** (67 ontologies are written at least in such a language). There are 3 ontologies which natural language is ‘Unknown’²⁷. Apart from English, that might be consider the base language, there appear other languages for the multilingual ontologies, namely: Bulgarian-bg, Czech-cs, German-de (2 ontologies), Spanish-es (2 ontologies), French-fr (2 ontologies), Hungarian-hu, Italian-it (3 ontologies), Dutch-nl, Norwegian-no, Polish-pl, Romanian-ro, Russian-ru, Slovak-sk and Swedish-sv. There are seven ontologies in the catalogue that are written in more than one natural language. These ontologies are Geonames, Units of Measure (OM), The W3C Organization Ontology, DUL (DOLCE+DnS Ultralite), URBAMET Ontology, Eurobau Utility Ontology, and FreeClassOWL Ontology. The distribution of natural languages used in the catalogue is shown in Figure 15.

²⁷ This situation occurs because the ontology documentation does not provide information about the natural language used. In addition, the code for those ontologies was not available, so it was not possible to discovery the language used for naming ontology elements.

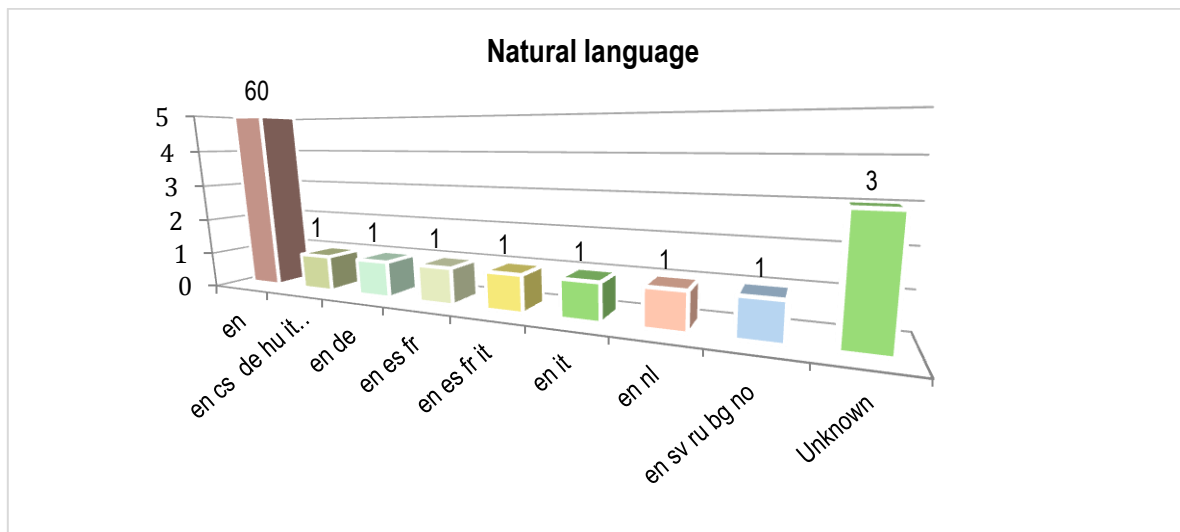

Figure 15. Distribution of natural languages in ontologies

Most of the ontologies (45 out of 70) in the catalogue have no information about licenses (ontology license is **Unknown**). In those cases in which authors provide license information, the most usual licenses are the CC-BY 3.0 Creative Commons Attribution Unported (8 ontologies have this type of license) and W3C software license (another 6 ontologies have this kind of license). The distribution of ontology licenses in the catalogue is shown in Figure 16. Such figure also shows that most of the licenses when available are open, more precisely among the 25 specified licenses, there is 1 ad-hoc license, 3 no open licenses set as “all rights reserved”, and 21 open licenses of different types.

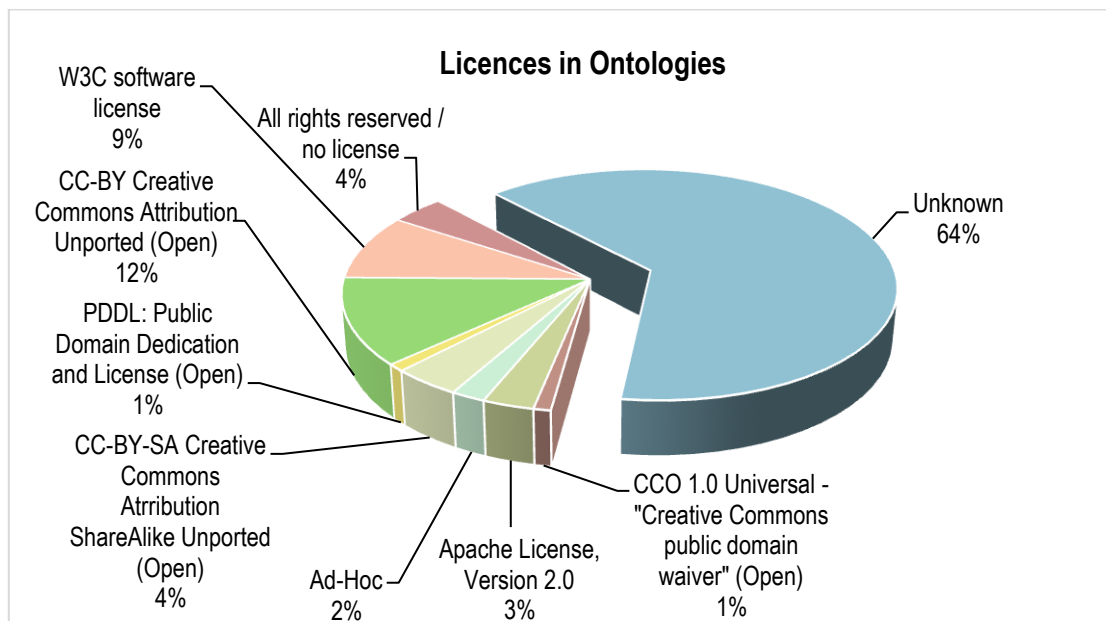

Figure 16. Ontology licenses distribution

UPM also analyzed the 70 ontologies in the catalogue with respect to the following quality indicators: online availability of ontologies and open license attached to the ontologies.

Regarding the online availability of ontologies, UPM performed two analyses: the first one refers to the availability of ontology code (RDF) and the second one refers to the availability of ontology documentation (HTML). In both cases²⁸ the study refers to:

- whether the corresponding content (RDF or HTML) can be retrieved in the given format according to content negotiation best practices for publishing RDF vocabularies (“Content Negotiation”)
- whether the content can be retrieved even though no content negotiation mechanisms are properly set up (“No Content Negotiation”)
- whether the content can not be retrieved (“Not Available”)
- other situations²⁹ (“Unknown”)

In the first case, **32 out of 70 ontologies can be retrieved in RDF**. However, 22 out of these 32 are retrieved although content negotiation mechanisms have not been properly set up. In addition, 4 ontologies cannot be retrieved in RDF and 6 probably are not available or are published in a wrong way. The distribution of RDF availability in the catalogue is shown in Figure 17.

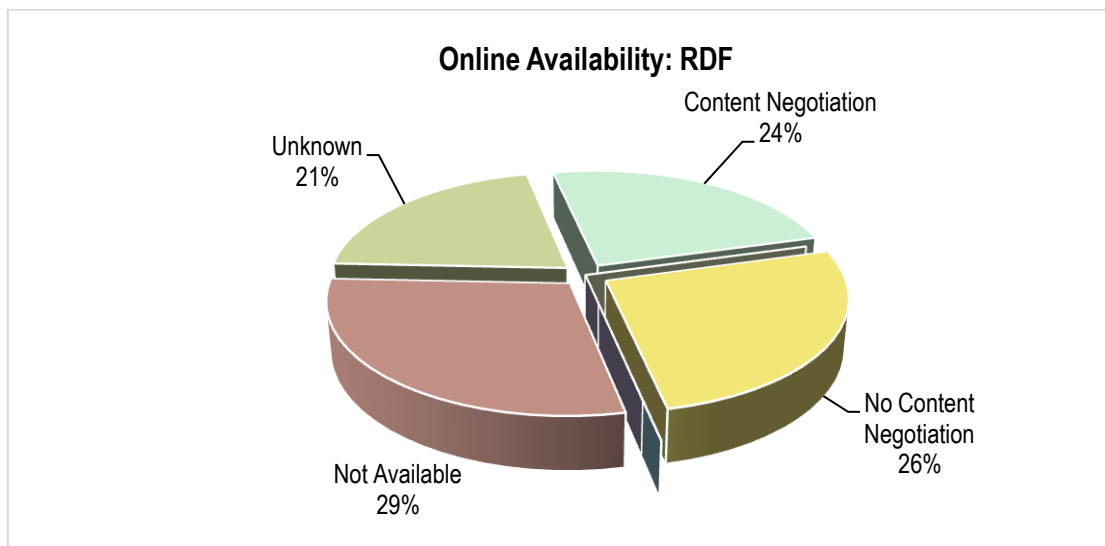

Figure 17. Distribution of RDF availability

In the second case, **26 out of 70 ontologies can be retrieved in HTML**; 15 of them have property content negotiation mechanism implemented. 34 ontologies cannot be retrieved in HTML and 10 probably are not available or are published in a wrong way. The distribution of HTML availability in the catalogue is shown in Figure 18.

²⁸ In order to check content negotiation mechanisms for RDF and HTML formats, the linked data validator Vapour (<http://validator.linkeddata.org/vapour>) is used while the RDF content of the available ontologies are loaded in a JENA (<http://jena.apache.org/>) model.

²⁹ This means that Vapour provides an exception.

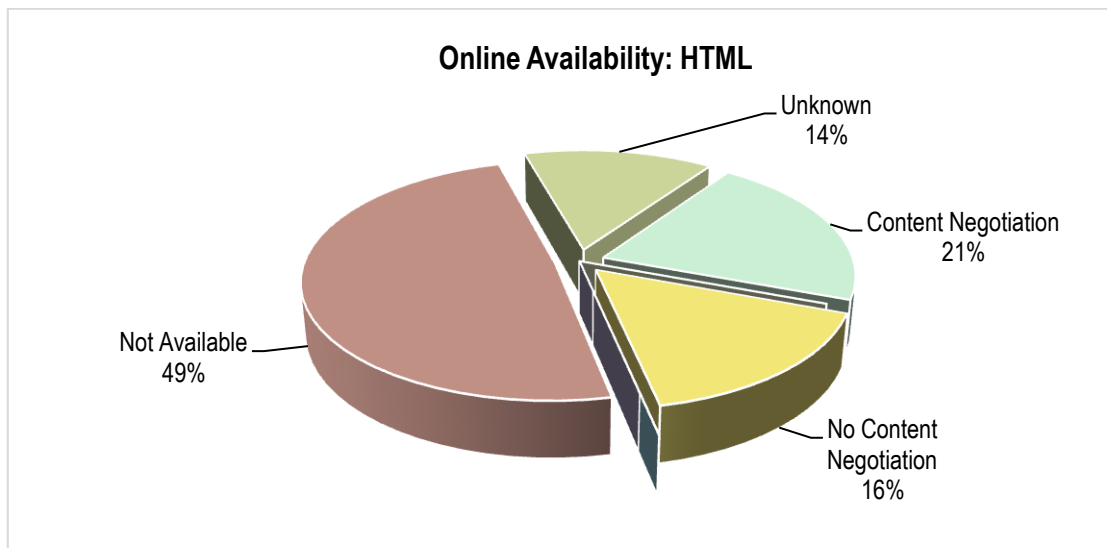

Figure 18. Distribution of HTML availability

Domain coverage analysis

Regarding the specific domains identified in Deliverable D3.1, at first the set of ontologies in the catalogue covers

- the **five domains identified for Level 1**, that is, Temporal, Organisational, Statistical, Spatial/Geographical, and Measurement
- **3 out of 7 domains identified for Level 2**. These domains are Energy, Weather, and Building. Thus, Climate Zone, Environmental, Occupancy, and User Behaviour do not seem to be covered.

Total figures of ontologies related with Level 1 domains and with Level 2 domains are shown respectively in Figure 19 and Figure 20.

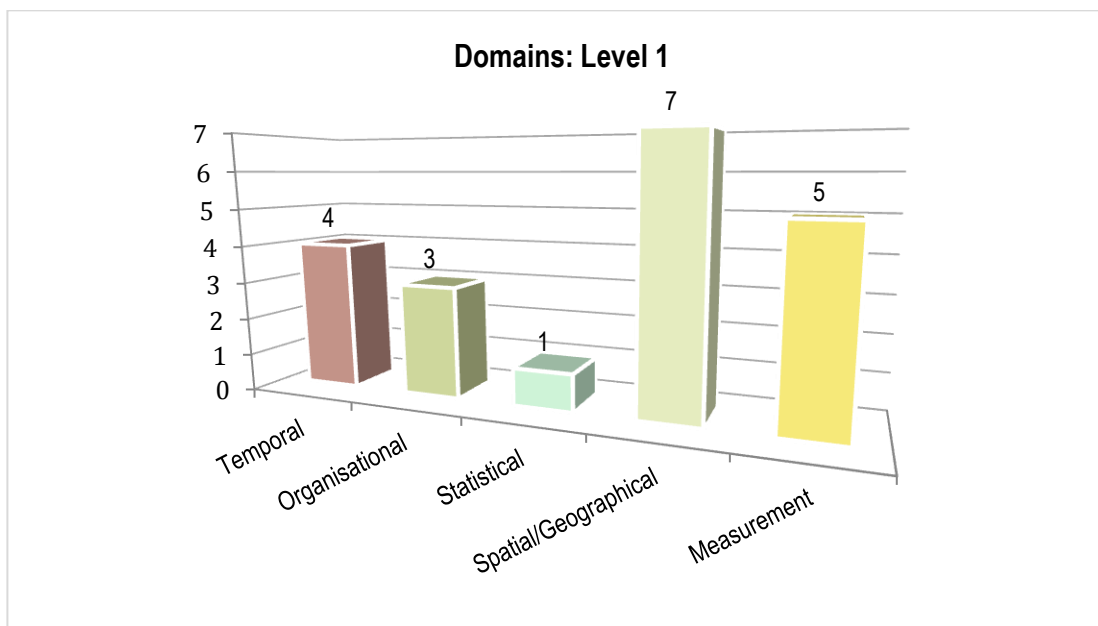

Figure 19. Number of ontologies in Level 1 domains

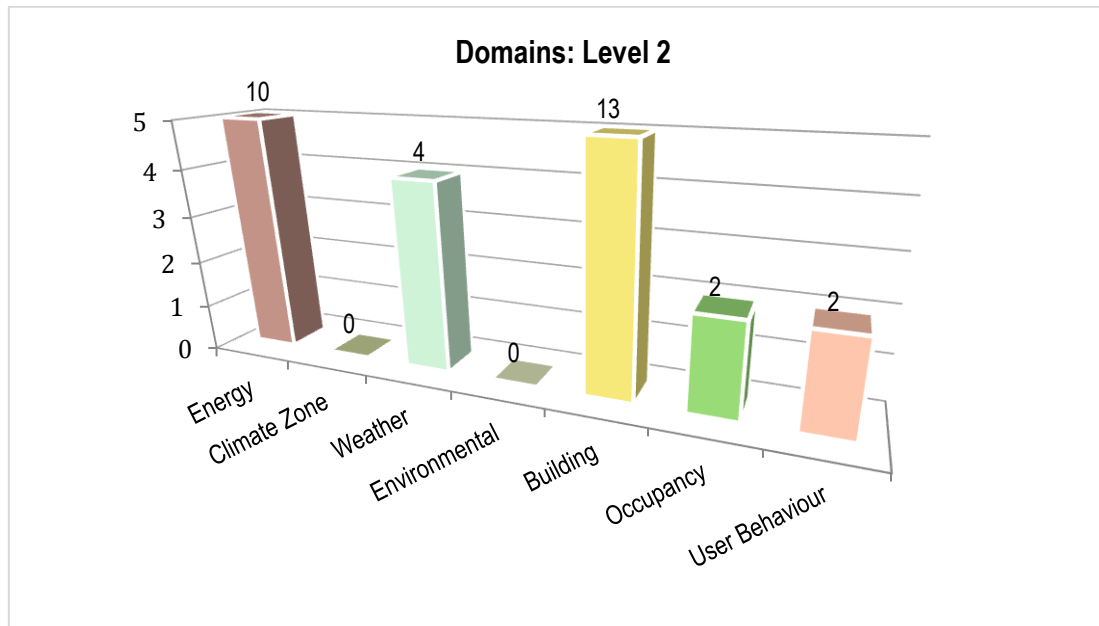

Figure 20. Number of ontologies in Level 2 domains

UPM also analyzed the list of domains attached to the ontologies by catalogue populators. As a result of this analysis, 16 new domains were identified. The full list of domains found and the number of ontologies in which they appear are shown in Table 4.

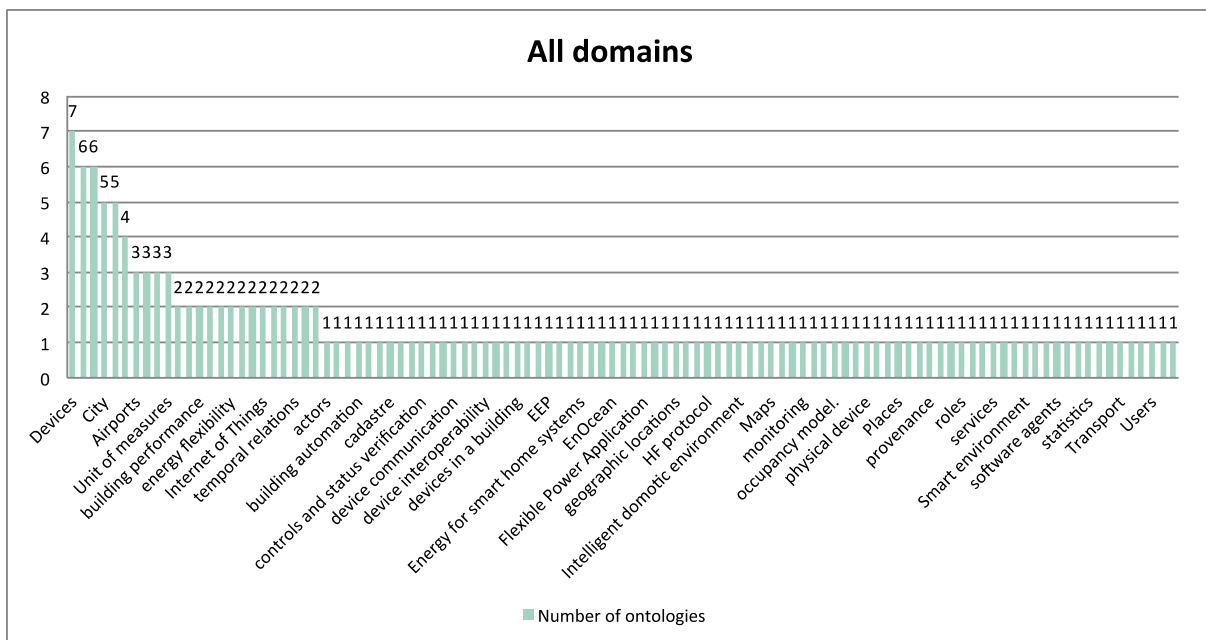

Figure 21. Number of ontologies in new domains

6.4.2 Datasets

At the moment of writing this deliverable, the Ready4SmartCities Dataset Catalogue contained twenty datasets. In the following, a summary of the main characteristics of the datasets is presented.

The datasets cover the domains *building design and measurement, building operation, outcome metrics, and weather and climate data, energy, housing market, location, traffic, parking and pollution,*

For six datasets no license has been given (unknown); the datasets with a license include *CC-BY-SA Creative Commons Attribution-ShareAlike Unported (Open)*, *CC-BY Creative Commons Attribution unported (Open)*, *UK Open Government Licence (OGL)* and *PDD* as shown in Figure 22

The format of the datasets is usually N triples and RDF as Figure 23 depicts. Out of the twenty datasets in the catalogue, seven have been recorded as originating from a European project. Two of the datasets are not available in bulk.

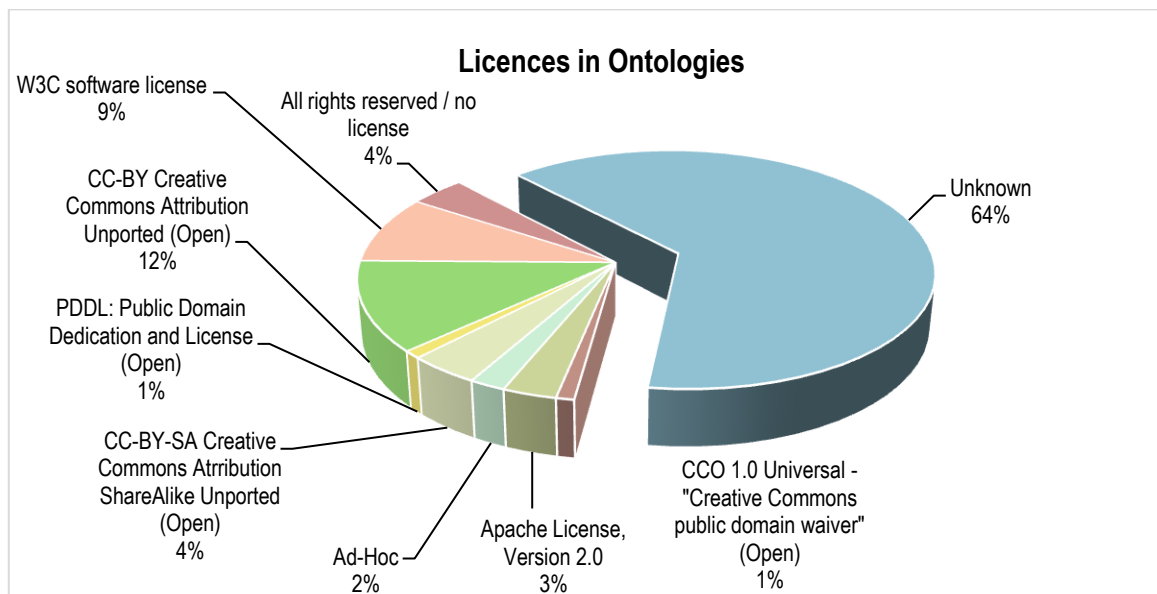

Figure 22. Dataset licenses distribution

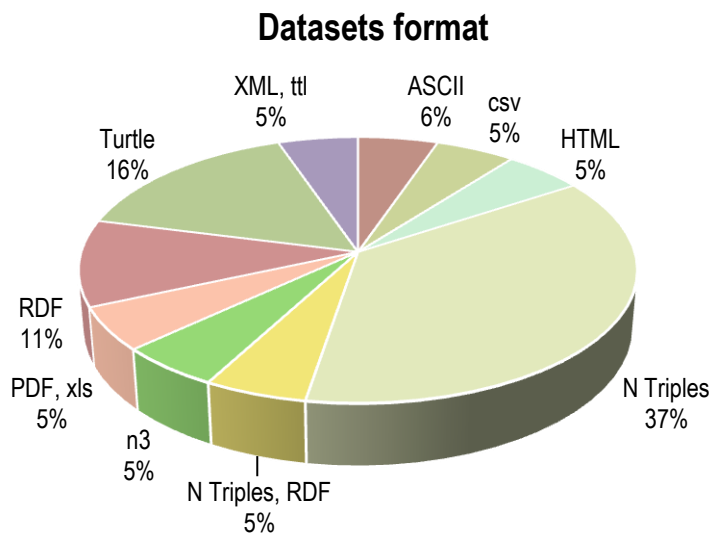

Figure 23. Datasets formats provided

6.4.3 Ontology alignments

As expected at the beginning of the project, there are not many alignments available. Some stakeholders told us that such alignments were part of their proprietary ontologies. Isolating and sharing alignments, however, has the benefit that it can be adopted and improved by others.

So, we take the active step of trying to obtain alignments from the ontologies themselves as described in Section 6.3. We review here the result of this process as available in the Alignment server.

The following table provides the list and statistics about the ontologies which are matched in the Alignment server. These ontologies come from the R4SC ontology catalog. We simply selected those which were available at the moment we started. But we discovered that some of these ontologies were importing or referring to other relevant ontologies, so we included these as well. Finally, during the process three ontologies were considered as worthwhile additions, so they have been included as well. Hence, the following table is organised in four parts:

- the 10 core ontologies identified in 2014,
- the available ontologies end of 2014,
- the additional ontologies, and
- the referred ontologies.

	Nickname	#Class	#Properties	#Instances	#C+P+I (glob)	#Triples	Imports
2014 core	bfo	39	0	0	48	429	
	bonsai	54	72	1	216	845	CoDAMoS, services
	cose	138	58	34	235	690	
	dog	763	79	0	848	10625	
	dolce	37	70	0	107	752	
	dul	75	109	0	188	1807	
	energyresource	523	110	16	723	9331	time
	ifc2x3	952	948	0	1901	14807	
	semanco	978	851	21	10280	55961	sumo
um	933	56	1700	2689	28000		
2014 catalog	actor	36	20	6	132	837	time
	building	31	5	0	36	227	
	cmo	2	4	0	8	21	qudt
	cube	15	21	1	37	266	
	geonames	7	29	699	735	6846	
	measurement	6	8	2	16	95	
	muo	10	17	0	27	127	
	org	9	35	1	45	748	
	places	47	4	0	51	566	
	process	156	38	6	268	2985	time
	rov	1	6	0	7	86	
	ssn	41	39	0	278	2370	dul
	time	11	41	14	67	297	
	timeline	22	43	1	211	1262	time, time-entry
	trade	141	106	34	302	1645	temporal
	weather	106	33	11	223	3124	time
wgs84	0	5	0	5	33		
new	ifc4	1221	1576	1624	4421	38178	
	lgdo	1200	222	0	1422	24530	
	saref	110	42	73	310	1382	wgs, time
Extra	codamos	40	37	0	77	217	
	dbpedia	*					
	foaf	15	68	13	96	631	
	geography	2	18	0	20	80	
	geovocab	1	16	0	17	138	
	goodrelations	37	112	47	196	1834	
	qudt	199	72	0	271	1992	
	schema	295	184	0	479	3495	
	scovo	3	5	0	8	84	
	sumo	4525	802	85644	90971	587998	
	temporal	7	5	7	19	82	
time-entry	17	48	7	72	312		

From these ontologies the following table provides the total number of alignments, non empty alignments and

	whole network			core network (raw)		
	#al	#ne-al	#corresp	#al	#ne-al	#corresp
aroma	429	204	4048	45	41	1267
edna .7	411	233	8021	45	40	1105
exact	410	161	6307	45	33	606
logmap	427	263	3377	46	38	634
smoa .9	403	239	5862	45	40	1268
Total	2080	1100	27615	226	192	4480
Aggregated	457	348	10342	45	45	2497

correspondences provided by each method on the whole network or the core ontologies.

Once aggregated, these alignments have generated 10342 correspondences distributed in 348 alignments. The 10342 correspondences of these alignments were curated by hand, as described in Section 6.3. The final result of this process is a network of alignments containing 5786 correspondences in 317 alignments.

	#al	#corresp
Initially	348	10342
Global	317	5786
IFC4-ifc2x3	1	2283
without IFC4-ifc2x3	316	3503

As explained in part A of this deliverable, one alignment between the two versions of IFC, contains 2283 correspondences. The list of the 21 largest alignments in the network given below shows a quick decrease of the size of alignments.

#corresp	alignment
2283	IFC4-ifc2.rdf
473	dog-energyresource.rdf
179	IFC4-um.rdf
125	ifc2-um.rdf
76	saref-energyresource.rdf
73	saref-dog.rdf
71	IFC4-saref.rdf
70	IFC4-semanco.rdf
70	dul-ssn.rdf
67	IFC4-dog.rdf
66	IFC4-energyresource.rdf
57	lgdo-ifc2
55	IFC4-cose.rdf
54	energyresource-semanco.rdf
51	lgdo-IFC4
46	IFC4-dul.rdf
42	saref-ifc2.rdf
42	semanco-um.rdf
41	cose-dog.rdf
36	ifc2-semanco.rdf

This is further confirmed by Figure 25 (in which the IFC4-ifc2x3 alignment is not taken into account) which shows the long tail shape of the distribution of alignments along their size.

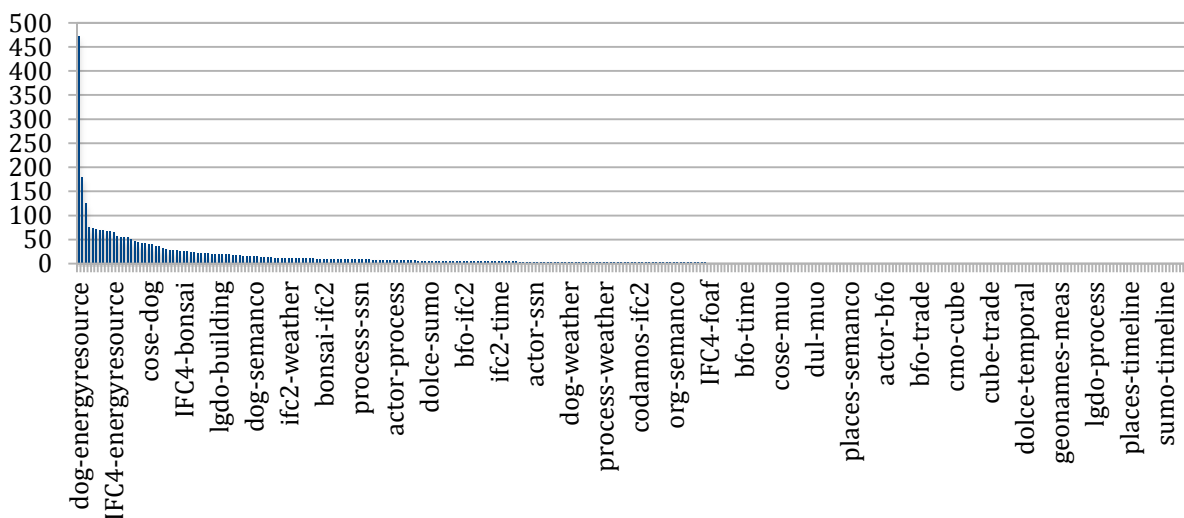

Figure 24. The long tail distribution of the alignments according to their size

In order to have an idea of the quality of the resulting alignments, we compared the raw alignments after aggregation and the final curated alignments with those obtained last year on the core ontologies. The results are reported in the following table. The measures used for comparing them (unlabelled) are precision, recall and F-measure, usually used in information retrieval and for evaluating alignments. We also report the respective size of R, the alignment obtained in 2014 and A the first and final alignments.

As expected, the first step does preserve all the 888 correspondences obtained last year and produces 1609 new correspondences. Hence, the recall attains 100% while the precision is low at 36%. After curation, the balance is reinstated with a 67% precision which gives a 75% F-measure. After curation, 144 correspondences are missing and 732 new correspondences have been added to the alignments. On the missing correspondences, 98 come from the alignment between dog and energy resources and this calls for more inspection.

These figures, however, should not be taken too seriously as the alignments of 2014 are not a paramount reference. They simply shows that the two processes have provided results which are largely commensurate.

It is necessary to have more scrutiny by experts of the domain.

For a more qualitative insight, we reproduce below the table produced in previous deliverable for the ifc2x3-bonsai alignment:

IFC2x3	Bonsai	SMOA .9	EDNA .7	Observation
parameter	parameter	1.0	1.0	
ifcBuilding	Building	1.0	1.0	
frequency	frequency	1.0	1.0	
ifcPoint	Point	1.0	1.0	
values	value	.97	.83	?
mode	Model	.97	.8	#
ifcActuatorType	Actuator	.94		hasType
inputPhase	hasInput	.94		?
ifcCondition	AirCondition	.93	.75	>
ParameterList0	parameter	.93		?
ifcParameterValue	parameter	.93		hasValue
ifcServiceLife	Service	.93		?
ifcSensorType	Sensor	.92		hasType
ifcBuildingStorey	Building	.92		< ?
ifcPressureMeasure	Pressure	.91		
pointParameter	parameter	.91		< ?
ifcBuildingElement	Building	.91		isPartOf
rateDateTime	dateTime	.9		< ?
ifcActuatorTypeEnum	Actuator	.9		

Clearly, the four first correspondences seem to be correct, then half of the supplementary correspondences. EDNA thresholded at .7 finds fewer correspondences (13) which are, in general, less meaningful.

This can be compared with the final result for the same two ontologies in the full network of ontologies.

IFC2x3	Bonsai	Relation	Confidence	Observation
parameter	parameter	=	1.0	
frequency	frequency	=	1.0	
ifcPoint	Point	=	0.8	They are penalised because of the ifc prefix
ifcBuilding	Building	=	0.8	
parameter	hasParameter	=	0.8	
values	value	=	0.8	



lfcPressureMeasure	Pressure	=	0.7	
lfcCondition	AirCondition	>	0.5	
inputPhase	hasInput	<	0.2	
panelOperation	hasOperation	<	0.2	

The four first correspondences are still there and have been consolidated. The policy penalises the matches with lfc prefix because it is impossible to know if they are here for a good reason or not (maybe lfcBuilding is a particular type of building). Only two correspondences are new and many hasardous correspondences have been discarded in the final alignment.

7 The Interoperability Areas: Energy Management Systems and Energy Measurement and Validation

The domains covered in work packages two and three come from two main application areas which have common aspects that not only allow to follow the same methodology within both work packages but also to share a lot of resources in terms of ontologies, datasets and alignments. There is no clear borderline as one may expect, which finally led to the decision to have a single point of information for the catalogues. Nevertheless, there are important differences between the two application areas that are described below. However, using linked data we expect that both application areas will more and more converge in the future, which will lead to more robust and flexible solutions for both application areas. In order to pinpoint the common areas, the two tables below should provide the scope of work in both packages. The first table tries to characterise and compare both application areas, whereas the second table shows typical domains covered by work package 3.

WP2 is reviewing the linked data situation for Energy Management Systems (EMS). In general, EMS has a very broad scope and includes a lot of domains and stakeholders that depend on each other and must interact in order to be able to control and monitor energy production and consumption of electro-mechanical facilities. For several reasons it was decided in WP2 to first focus on the construction sector, which not only is a major energy consumer with high potentials for energy savings and peak energy balancing but it is also an energy producer and even a way for energy storage. There are a lot of use cases for smart cities that directly or indirectly relate to buildings, e.g. prediction of energy demands (based on the heating, cooling and lighting demands of buildings that is also linked to user behaviours) or traffic management (for e.g. travelling between office and residential areas). Also, the construction industry is an interesting environment for testing and promoting the linked data approach as there are many different stakeholders that must collaborate and share information.

WP3 addresses the need to validate the results of energy-efficiency actions by analysing their measured impact. Measuring consumption in smart cities provides the source of data to be validated (including measurement methods, predictive models and algorithms), but other factors also play a role in the analysis, such as weather and climate data, building characteristics, user behaviour, etc. Measurement and validation requires complete terminology for experimentation and piloting including experimental group, control group, statistical significance, outcome metrics (key performance indicators, KPIs), modelling parameters (e.g. occupancy, comfort levels, meteorology, etc.).

The ontologies and datasets described in the next sections have been selected because they address one or more of the topics work packages 2 or 3 focus on. Concerning alignments, their generation in a nearly blind way already allows for clustering ontologies and identifying clusters of ontologies related to these topics.

Table 1. Application areas of the domains in work packages 2 and 3

	Energy Management System (WP2)	Energy Measurement and Validation (WP3)
Main application area	Controlling a “single” electro-mechanical system either for energy production or energy consumption, automation of systems (machine-to-machine communication)	Measure and validate energy consumption and/or production to provide key figures for strategic and operative decisions, decision support and awareness services
Characteristics of used data		
degree of standardization	Medium	Low
degree of structured data	Very high	Medium
degree of complexity	High	Medium
degree of openness	Very low (outside of the “system” environment) Medium (within the “system”, if different players must work together)	Medium to High
fault tolerance	Low to very low	Medium
security requirements	Very high	Low to medium
amount of data	Medium to high	Very high
real-time requirements	Medium to very high	Low to medium

In total 70 ontologies and 18 datasets have been identified and catalogued. An overview can be seen in Table 2 and Table 3. For more results, see the gap analysis and the list of ontologies and datasets.

Table 2. Overview of ontologies identified in the project categorised in domains

	Provenance	Devices/Sensors	Time	Measurement	Upper Ontologies	Environmental data	Weather and climate data	Energy data	Organisation	Piloting	Modelling parameters	Outcome metrics (KPIs)	Statistics	Groups (experimental, control)	Systems: BACS, BEMS	GIS	Building operation	Optimizing performance	Controlling	Monitoring	Building design and refurbishment	User behaviour	Predictive models / Energy analysis	Methods of measurement	Metrics and indicators
Architecture and Building Physics Information																									
The W3C Organization Ontology																									
IFC2X3 - University of Ghent																									
IFC2X3 - NIST OntoSTEP Converter																									
The W3C Time Ontology																									
BFO (Basic Formal Ontology)																									
Weather and Exterior Influence Information																									
Units of Measure (OM)																									
Measurement Ontology																									
Users and Preference Information																									



Energy and Resource Information
MUO - Measurement Units Ontology
Casas Ontology for Smart Environments (COSE)
DOLCE (Descriptive Ontology for Linguistic and Cognitive Engineering)
DUL (DOLCE+DnS Ultralite)
Timeline Ontology
SESAME-S Smart Building Ontology
Simulation Information Model (SIM) Ontology
Performance Information Model (PIM) Ontology
The W3C SemanticThe W3C Sensor Network Ontology
Building Information Model (BIM) Ontology
Global City Indicator Foundation Ontology
User Behavior and Building Process Information
Cadastre and Land Administration Thesaurus (CaLThe)
CASCADE airport ontology
Nikola Tesla Airport (NTA) Ontology





trade
Geonames
Data Cube
The W3C PROV Ontology
DogOnt
SUMO (Suggested Upper Merged Ontology)
BOnSAI
OGC GeoSPARQL
WGS84 Geo Positioning
Open Street Map (OSM) ontology
Places Ontology
eDIANA context awareness ontology
Urban Energy Ontology
Concept Modelling Ontology (CMO)
Registered Organization Vocabulary





The Event Ontology
km4city
Internet of Things (IoT) Ontology
OpenIoT Ontology
SPITFIRE Ontology
Eurobau Utility Ontology
FreeClassOWL Ontology
CERISE CIM Profile for Smart Grids
COINS Building Information Model (CBIM)
CASCADE Fiumicino Airport ontology
CASCADE Malpensa Airport ontology
Energy in Buildings Ontology
INERTIA Ontology
INSPIRE Data Specification on Transport Networks
CityGML Ontology



URBAMET Ontology	■	■	■	■	■	■	■
SAREF: The Smart Appliances REFerence ontology							■
DECT ULE ontology		■	■	■	■		
Echonet ontology							■
EnOcean ontology							■
FAN FPAI ontology				■			■
FIEMSER ontology			■	■	■	■	■
FIPA Device Ontology							■
Hydra Basic Device Information ontology							■
SmartCoDE ontology	■						■
Mirabel ontology		■				■	■
Stream Annotation Ontology - SAO						■	■
Adapt4EE Ontology		■	■	■	■		■
ROUTE - Ontology of Urban Transportation Entities					■		■

Table 3. Overview of datasets identified in the project categorised in domains

	Provenance	Devices/Sensors	Time	Measurement	Upper Ontologies	Environmental data	Weather and climate data	Energy data	Organisation	Piloting	Modelling parameters	Outcome metrics (KPIs)	Statistics	Groups (experimental, control)	Systems: BACS, BEMS	GIS	Building operation	Optimizing performance	Controlling	Monitoring	Building design and refurbishment	User behaviour	Predictive models / Energy analysis	Methods of measurement	Metrics and indicators
Eurobau database																									
Daily Global Weather Measurements, 1929-2009 (NCDC, GSOD)																									
Repener building energy																									
Enipedia Energy Industry Data																									
Linked Clean Energy Data																									
State Energy Data System																									
Energy efficiency assessments and improvements																									
Residential Energy Consumption Survey																									



Housing Market Indicators	■								
INERTIA Ontology dataset instance	■	■	■	■	■				
Number of dwellings by tenure and district in the UK	■								
Impact indicator: energy efficiency of new build housing in the UK			■				■		
Vehicle Traffic Data, Provided by City of Aarhus in Denmark						■			
Parking Data Stream, Provided by City of Aarhus in Denmark						■			
Pollution Data, Provided by City of Aarhus in Denmark								■	
Weather Data, Provided by City of Aarhus in Denmark								■	
Energy time-series mapping from University of Southampton							■		
Linked geodata dataset									■

8 Collected ontologies

8.1 Gap analysis

The version of the Ready4SmartCities Ontology Catalogue current at the time of writing contained **70 ontologies**. According to relevant domains, the current set of ontologies in the Ready4SmartCities catalogue covers the 5 domains identified for Level 1 (Temporal, Organisational, Statistical, Spatial/Geographical, and Measurement) and 4 out of 7 domains identified for Level 2 (Energy, Weather, Building, and User Behaviour). Thus, there are three domains for which there are no ontologies in the catalogue, namely, Climate Zone, Environmental, and Occupancy. It is worth mentioning that 16 additional domains are also covered.

Regarding the ontology language, 74% of the ontologies in the catalogue are implemented in OWL, one of the most common languages for developing ontologies. Only three ontologies are implemented using more than one ontology language; these are Timeline Ontology, Stream Annotation Ontology - SAO and Data Cube, which are implemented in OWL and RDF-S. In order to benefit the interoperability and the usability of ontologies in different contexts, it could be beneficial to have more ontologies both in OWL and in RDF-S.

With respect to the syntaxes or formats for ontologies, 71.43% of them are provided in RDF/XML and 28.5% of these ontologies are in Turtle (it is worth noting that some ontologies are given in RDF/SML and also turtle). There are eight ontologies provided in more than one format

67 ontologies in the catalogue are written in English, which is the most common natural language in research tasks. Currently, there are seven ontologies specially written in more than one natural language; namely Geonames, Units of Measure (OM), The W3C Organization Ontology, DUL (DOLCE+DnS Ultralite), URBAMET Ontology, Eurobau Utility Ontology, and FreeClassOWL Ontology. The natural languages used in such ontologies are Bulgarian, Czech, German, Spanish, French, Hungarian, Italian, Dutch, Norwegian-, Polish, Romanian, Russian, Slovak and Swedish. Since multilingualism is a key issue, the catalogue should include more ontologies written in different languages.

A not really good point in the catalogue is that only open licenses are attached to those ontologies with license information. Regarding ontologies 64% of them provide no information about licensing.

With respect to the online availability of the ontologies in the catalogue, half of the ontologies can be retrieved in RDF. However, 26% of the ontologies do not have content negotiation mechanisms properly set up for this format and 29% cannot be retrieved in RDF. This situation should be corrected. Regarding HTML availability, 37% of the ontologies can be retrieved in such a format. However, 49% of the ontologies cannot be retrieved in HTML, which normally provides ontology documentation. Thus, in order to benefit the understanding and reuse of the ontologies, this situation should be also improved.

In addition, it is worth mentioning that in some cases the negotiation mechanisms seem to be good established, however the retrieved content does not correspond with the expected ones. This occurs when the ontology URI follows the pattern "www.owl-ontologies.com/" or contains only names (e.g., "CityEnergyInvestmentStudy"). This situation should also be corrected.

8.2 List of ontologies

Architecture and Building Physics Information

Name	Architecture and Building Physics Information
Author and License	Institute of Computer Aided Automation, Vienna University, Austria unknown license
URL	https://www.auto.tuwien.ac.at/downloads/thinkhome/ontology/BuildingOntologySharedVocabulary.owl
Description	An ontology representing building information (e.g. structure, material, architecture) for Smart Home Systems. Classes, axioms and customized datatypes have been retrieved from gbXML (www.gbxml.org). (for further information see: https://www.auto.tuwien.ac.at/projectsites/thinkhome/building-information.html). The mapping from gbXML is done through an XSLT script, which is also available on the website.
Scope (Domain)	Buildings, Energy Analysis
Use cases (Motivation, Relevance)	There are many use cases for smart cities where building data is of relevance. gbXML data is typically used for energy analysis, which is done in the design phase of a building.
Data sets	gbXML datasets can be generated and imported by many CAD and energy analysis tools. However, these tools export a XML file according to the gbXML schema definition and thus has to be mapped to an RDF representation according to this ontology. Sample gbXML files are available at www.gbxml.org . However, building data is typically not published as it is mainly shared within the design team only or are handed over to contractual partners.
Open issues/ Challenges	There is an agreed schema developed by the gbXML initiative. This is the baseline definition from which this ontology was derived based on an XSLT script.
Tool support	Population of the ontology through mapping approaches from traditional CAD tools.

The W3C Organization Ontology

Name	The W3C Organization Ontology
Author and License	Dave Reynolds, Epimorphics Ltd. W3C license
URL	www.w3.org/ns/org#

Description	Vocabulary for describing organizational structures, specializable to a broad variety of types of organization.
Scope (Domain)	Organization, Piloting
Use cases (Motivation, Relevance)	<p>The motivation for creating the ontology was seen in the need to publish information relating to government organizational structure as part of the data.gov.uk initiative. The approach chosen was to develop a small, generic, reusable core ontology for organizational information and then let developers extend and specialize it to particular domains.</p> <p>In the energy domain, the ontology can be used and extended to describe organisations and sites that partake in energy-related projects, e.g. piloting innovative solutions that save energy, developing and testing new technologies like smart metres, etc.</p>
Data sets	Based on the listed implementation of the ontology, it has been used in domains such as healthcare and public organisations (universities, libraries, museums), but not in the energy domain. No datasets could be found thus far that use the ontology.
Open issues/ Challenges	
Tool support	

IFC Ontology

Name	IFC2X3 - University of Ghent
Author and License	Davy Van Deursen, Pieter Pauwels (mapping configuration from IFC2x3 Express specification from buildingSMART), unknown license
URL	http://multimedialab.elis.ugent.be/organon/ontologies/IFC2X3#
Description	OWL representation of the buildingSMART data model. The IFC data model is written in an EXPRESS schema (IFC2x3). This ontology is the result of an automated transformation of this EXPRESS schema into an OWL ontology. In this transformation process, every EXPRESS element that has a direct equivalent in OWL is mapped onto this equivalent. More specifically, for each ENTITY element in EXPRESS a corresponding OWL class is generated, EXPRESS attributes are converted into the appropriate OWL properties, etc.
Scope (Domain)	Buildings, AEC industry, BIM
Use cases (Motivation, Relevance)	The IFC data model supports data sharing of BIM data. It supports coordination of design activities and hand-over of design and maintenance data. There are many use cases for smart cities where building data is of relevance, either to be referenced (in particular for

	EMV use cases) or actively used by building simulation and maintenance (EMS use cases).
Data sets	<p>IFC datasets can be generated by all major CAD tools. However, these tools export IFC data in the original SPF format only and thus has to be mapped to an RDF representation according to this ontology.</p> <p>Public IFC files are available from pilot and research projects mainly. However, building data is typically not published as it is mainly shared within the design team only or are handed over to contractual partners.</p>
Open issues/ Challenges	<p>There is an agreed standard developed by the buildingSMART organisation. This is the baseline definition from which an ifcOWL representation can be derived and enriched. So far, there are several mapping approaches, all of them dealing with slightly different requirements and boundaries. All mapping approaches will lose some sort of information as OWL is not able to deal with all constraints specified in the original IFC EXPRESS definition. Also, none of available mapping approaches is enriching the original definition.</p>
Tool support	

NIST OntoSTEP Converter plugin for Protégé

Name	IFC2x3 NIST OntoSTEP Converter
Author and License	Rachuri Sudarsan, Raphael Barbau, Sylvere Krifa; (developer of this tool) (mapping configuration from IFC2x3 Express specification from buildingSMART -> OWL-DL representation), unknown license
URL	http://www.nist.gov/OntoSTEP/ifc2x3 (download of the tool)
Description	See IFC Ontology
Scope (Domain)	Buildings, AEC industry, BIM
Use cases (Motivation, Relevance)	See IFC Ontology
Data sets	See IFC Ontology
Open issues/ Challenges	See IFC Ontology
Tool support	Plugin for Protégé that enables to convert EXPRESS schemata and SPF datasets.

The W3C Time Ontology

Name	The W3C Time Ontology
Author and License	Jerry R. Hobbs, Feng Pan W3C license
URL	http://www.w3.org/2006/time
Description	This ontology of temporal concepts provides a vocabulary for expressing facts about topological relations among instants and intervals, together with information about durations and about date time information.
Scope (Domain)	Metrics and indicators, Methods of measurement (scales, units, classifications), Time
Use cases (Motivation, Relevance)	The specification of temporal information is necessarily required for bringing the Semantic Web into reality. In ubiquitous and pervasive computing, a time ontology is crucial for modelling and reasoning about the time dimension of the context. When it comes to measuring energy consumption, the temporal aspect is clearly of relevance (e.g. When/How often is energy usage measured? – date, time, interval).
Data sets	
Open issues/ Challenges	The OWL Time ontology is in the state of a "first public working draft" (FPWD), which has been created by the Semantic Web Best Practices and Deployment Working Group (SWBPD). The SWBPD has finished in 2006 and so work on the Time ontology has been discontinued.
Tool support	

BFO (Basic Formal Ontology)

Name	BFO (Basic Formal Ontology)
Author and License	Pierre Grenon. License: CC-BY Creative Commons Attribution Unported (Open) http://creativecommons.org/licenses/by/3.0/
URL	http://www.ifomis.org/bfo/1.1
Description	BFO is an upper level ontology that is designed for use in supporting information retrieval, analysis and integration in scientific and other domains. However, it does not contain physical, chemical, biological or other terms which would properly fall within the coverage domains of the special sciences.

Scope (Domain)	Top level ontology
Use cases (Motivation, Relevance)	Upper level ontologies could be used for data integration across datasets
Data sets	Upper level ontologies could be used in a high number of datasets as they represent top concepts
Open issues/ Challenges	Unknown
Tool support	Unknown

Weather and Exterior Influence Information

Name	Weather and Exterior Influence Information
Author and License	Automation Systems Group, Institute of Computer Aided Automation, Vienna University of Technology unknown license
URL	https://www.auto.tuwien.ac.at/downloads/thinkhome/ontology/WeatherOntology.owl
Description	This smart home ontology for weather phenomena and exterior conditions was issued in 2011 as part of the ThinkHome project, which aimed to create an adaptive regulation for maximising energy efficiency in buildings. Shortly HOMEWEATHER, the ontology imports and extends W3C's Time ontology.
Scope (Domain)	Weather and climatic data, environmental data (e.g. pollution), Time, Modelling parameters, Controlling
Use cases (Motivation, Relevance)	The ontology covers a wide range of weather and climate data, such as atmospheric pressure, humidity, precipitation, temperature, wind, etc. In a smart home context, these data can be used to infer the proper action and perform tasks most energy-efficiently.
Data sets	
Open issues/ Challenges	
Tool support	

Units of Measure (OM)

Name	Units of Measure (OM)
Author and License	Hajo Rijgersberg, Mark van Assem, Don Willems, Mari Wigham, Jeen Broekstra, Jan Top CC-BY 3.0 license
URL	http://www.wurvoc.org/vocabularies/om-1.8/
Description	The Ontology of units of Measure and related concepts (OM) models concepts and relations important to scientific research. It has a strong focus on units and quantities, measurements, and dimensions.
Scope (Domain)	Measurement, Time, Metrics and indicators
Use cases (Motivation, Relevance)	Some classes relevant to the energy domain include electricity and magnetism (e.g. electric charge, electric conductivity, current, etc.) and space and time (e.g. area, height, length, period, time, etc.).
Data sets	
Open issues/ Challenges	
Tool support	

Measurement Ontology

Name	Measurement Ontology
Author and License	Ian Jacobi, Computer Science and Artificial Intelligence Laboratory, Massachusetts Institute of Technology unknown license
URL	http://www.telegraphis.net/ontology/measurement/measurement#
Description	The Measurement Ontology is an ontology in which measurements may be rendered. A measurement is a statistic that measures a quantity that may or may not have units. Relevant classes include measurement, quantity, unit, etc.
Scope (Domain)	Measurement, Methods of measurement (e.g. scales, units, classifications)
Use cases (Motivation,	SmartHome Weather references it

Relevance)	
Data sets	
Open issues/ Challenges	
Tool support	

Users and Preference Information

Name	Users and Preference Information
Author and License	Institute of Computer Aided Automation, Vienna University, Austria unknown license
URL	https://www.auto.tuwien.ac.at/downloads/thinkhome/ontology/ActorOntology.owl
Description	<p>An ontology describing user information and preferences for Smart Home Systems.</p> <p>User profiling knowledge includes information about human characteristics (e.g age and gender) and preferences (e.g. visual and thermal habits) allowing the formulation of different habit patterns.</p> <p>This ontology came as a result of ThinkHome project, which utilizes artificial intelligence to improve control of home automation functions provided by dedicated automation systems.</p> <p>(for further information see https://www.auto.tuwien.ac.at/projectsites/thinkhome/user-information.html)</p>
Scope (Domain)	User Preferences, User Profiling, User Scheduling, Energy Management
Use cases (Motivation, Relevance)	<p>There are many use cases for smart cities where smart home occupancy data is of relevance. In particular, these data offer valuable information about :</p> <ul style="list-style-type: none"> • thermal and visual preferences • configured schedules for energy profiling <p>Advanced control automations related to this data can significantly improve energy-efficiency and energy-saving, yet preserving used comfort and preferences.</p>
Data sets	As reported in ThinkHome project, all data collected will be publicly available through a dedicated web-site. There is no other evidence that this ontology has already been used by other projects/applications, in order to seek for more available data-sets.
Open issues/ Challenges	

Tool support	
--------------	--

Energy and Resource Information

Name	Energy and Resource Information
Author and License	TU Vienna
URL	https://www.auto.tuwien.ac.at/projectsites/thinkhome/facilities-and-energy-information.html https://www.auto.tuwien.ac.at/downloads/thinkhome/ontology/energy/changelog/EnergyResource_Revision_1.03.txt
Description	An ontology representing energy information for Smart Home Systems.
Scope (Domain)	Home Automation
Use cases (Motivation, Relevance)	
Data sets	https://www.auto.tuwien.ac.at/downloads/thinkhome/ontology/EnergyResourceOntology.owl https://www.auto.tuwien.ac.at/downloads/thinkhome/ontology/EnergyResourceOntologyExample.owl
Open issues/ Challenges	
Tool support	

Measurement Units Ontology

Name	MUO Measurement Units Ontology
Author and License	Luis Polo, Diego Berrueta, Fundación CTIC License not specified
URL	http://mymobileweb.morfeo-project.org/specs/name (Not available)
Description	Ontology representing measurements units, in terms of base, complex, derived units.
Scope (Domain)	All measured entities

Use cases (Motivation, Relevance)	It is relevant due to the necessity to compare same type entities specified in different measure units, such as energy expressed in cal rather than J or Wh.
Data sets	
Open issues/ Challenges	
Tool support	

Casas Ontology for Smart Environments (COSE)

Name	Casas Ontology for Smart Environments (COSE)
Author and License	School of Electrical Engineering and Computer Science, Washington State University, Box 642752, Pullman, WA, 99164-275
URL	-
Description	The number of smart appliances and devices in the home and office has grown dramatically in recent years. Unfortunately, these devices rarely interact with each other or the environment. In order to move from environments filled with smart devices to smart environments, there must be a framework for devices to communicate with each other and with the environment. This enables reasoners and automated decision makers to understand the environment and the data collected from it. Semantic web technologies provide this framework in a well-documented and flexible package. In this paper we present the Casas Ontology for Smart Environments (COSE) and accompanying data from a test smart environment and discuss the current and future challenges associated with a Smart Environment on the Semantic Web.
Scope (Domain)	Smart Environments, Ambient Assisted Living
Use cases (Motivation, Relevance)	
Data sets	
Open issues/ Challenges	
Tool support	

DOLCE

Name	DOLCE (Descriptive Ontology for Linguistic and Cognitive Engineering)
Author and License	Claudio Masolo License unknown.
URL	http://www.loa-cnr.it/ontologies/DOLCE-Lite.owl#
Description	DOLCE is the first module of the WonderWeb Foundational Ontologies Library (WFOL). DOLCE has a clear cognitive bias, in the sense that it aims at capturing the ontological categories underlying natural language and human common-sense. its authors believe that such bias is very important for the Semantic Web. DOLCE is an ontology of particulars, in the sense that its domain of discourse is restricted to them. A basic choice we make in DOLCE is the so-called multiplicative approach: different entities can be co-located in the same space-time (e.g. the vase and the amount of clay).
Scope (Domain)	Top level ontology
Use cases (Motivation, Relevance)	Upper level ontologies could be used for data integration across datasets
Data sets	Upper level ontologies could be used in a high number of datasets as they represent top concepts
Open issues/ Challenges	
Tool support	

DUL Ontology

Name	DUL (DOLCE+DnS Ultralite)
Author and License	Aldo Gangemi. License unknown.
URL	http://www.ontologydesignpatterns.org/ont/dul/DUL.owl
Description	It is a simplification and an improvement of some parts of DOLCE Lite-Plus library (cf. http://dolce.semanticweb.org), and Descriptions and Situations ontology (cf. http://www.ontologydesignpatterns.org/wiki/Ontology:DnS) Its purpose is to provide a set of

	upper level concepts that can be the basis for easier interoperability among many middle and lower level ontologies.
Scope (Domain)	Top level ontology
Use cases (Motivation, Relevance)	Upper level ontologies could be used for data integration across datasets
Data sets	Upper level ontologies could be used in a high number of datasets as they represent top concepts
Open issues/ Challenges	Unknown
Tool support	Unknown

The Timeline Ontology

Name	The Timeline Ontology
Author and License	Yves Raimond, Samer Abdallah. Centre for Digital Music in Queen Mary, University of London. Licensed under a Creative Commons Attribution License.
URL	http://motools.sf.net/timeline/timeline.n3
Description	This ontology defines the TimeLine concept, representing a coherent backbone for addressing temporal information. Each temporal object (signal, video, performance, work, etc.) can be associated to such a timeline. Then, a number of Interval and Instant can be defined on this timeline.
Scope (Domain)	Time managing. It useful for anything related to time or time depending.
Use cases (Motivation, Relevance)	The principal applications interests are any non-static process that need to gather information using a precise and synchronous time reference.
Data sets	
Open issues/ Challenges	The primary scope of this ontology (music and videos) could make the Timeline Ontology and its related tools more difficult to use in the Smart Cities contest.
Tool support	A tool created to manipulate data in this ontology: http://sourceforge.net/projects/motools/

SESAME-S Smart Building Ontology

Name	SESAME-S Smart Building Ontology
Author and License	Research Centre for Telecommunication (FTW, http://www.ftw.at/), Austria unknown license
URL	http://datahub.io/dataset/smartbuilding-sesames https://commondatastorage.googleapis.com/ckannet-storage/2012-08-20T165445/SmartBuildingv3.owl
Description	<p>SESAME-S = Semantic Smart Metering Services for Energy Efficient Houses</p> <p>This ontology is a typical example of a purpose-built ontology. It was developed within the SESAME project, which is already finished. The ontology is not maintained anymore and no further documentation is available. It contains about 20 class and 30 property definitions, thus being a rather small ontology in terms of size and scope. It is focused on the data that has been managed in the two real-world examples, e.g. measurements of temperature, humidity, light and presence of persons.</p>
Scope (Domain)	Smart Sensors, Devices
Use cases (Motivation, Relevance)	<p>The ontology was developed to show the “next generation of energy efficient buildings”. It is part of a prototype development to proof the concept of semantic smart metering and providing services for energy efficiency. One of the goals was to raise awareness for taking care of reducing energy consumption within a building by providing measured data to people who are using the facilities. More information about the project is available on their website (http://sesame-s.ftw.at/) and in a number of research publications, e.g. in: Girtelschmid, S., Steinbauer, M., Kumar, V., Fensel, A., Kotsis, G. "On the Application of Big Data in Future Large Scale Intelligent Smart City Installations", International Journal of Pervasive Computing and Communications, Emerald Group Publishing, Vol. 10 Iss: 2 (2014).</p>
Data sets	Data from two real-world examples have been managed with this ontology. One example from Austria, the Kirchdorf school example, and another one from Russia, the Chernogolovka factory example. The datasets are not public available as there are strong concern regarding security and privacy issues (actual energy consumption, usage patterns of the building).
Open issues/ Challenges	There is no maintenance and no further documentation of this ontology. It is used by the authors as a baseline for follow-up projects.
Tool support	Prototypes/tools developed in SESAME-S project.

Simulation Information Model (SIM) Ontology

Name	Simulation Information Model (SIM) Ontology
Author and License	unknown license
URL	http://www.modelservers.org/public/ontologies
Description	Developed and used in the IntUBE project (Intelligent Use of Building’s Energy Information), which was carried out from 2007 to 2010.
Scope (Domain)	Building usage, Building performance
Use cases (Motivation, Relevance)	Simulated data generated by energy simulation tools (including their input parameters)
Data sets	Examples from the IntUBE project available (see URL).
Open issues/ Challenges	The status of the ontology is unclear. Website (and domain) is not available
Tool support	Data managed in the “Energy-information integration platform”

Performance Information Model (PIM) Ontology

Name	Performance Information Model (PIM) Ontology
Author and License	unknown license
URL	http://www.modelservers.org/public/ontologies
Description	IntUBE project (Intelligent Use of Building’s Energy Information) – finished 2011 (project website no more available)
Scope (Domain)	Building usage, Building performance
Use cases (Motivation, Relevance)	dynamic data obtained from monitoring systems, including climate, building use and energy performance

Data sets	
Open issues/ Challenges	see Simulation Information Model (SIM) Ontology
Tool support	

The W3C Sensor Network Ontology

Name	The W3C Sensor Network Ontology
Author and License	W3C Semantic Sensor Network Incubator Group W3C Software Notice and License
URL	http://purl.oclc.org/NET/ssnx/ssn
Description	This ontology describes sensors and observations, and related concepts. It does not describe domain concepts, time, locations, etc. these are intended to be included from other ontologies via OWL imports. (For further information see : http://www.w3.org/2005/Incubator/ssn/wiki/Report_Work_on_the_SSN_ontology)
Scope (Domain)	Sensors, Sensors Measuring, Monitoring, Devices
Use cases (Motivation, Relevance)	Measuring and Monitoring support the basis of the intelligent operation. Valuable information about <ul style="list-style-type: none"> • Sensors as a device () • Measuring operations and measuring capability. • Device http://purl.oclc.org/NET/ssnx/ssn#Device <p>Five working examples are already included in the reference wiki page, illustrating the application of different parts of this ontology, such as: University deployment, Smart product, Wind sensor, Agriculture Meteorology and Linked Sensor Data.</p>
Data sets	The W3C Semantic Sensor Network Incubator Group maintains hosts a wiki reference page since 2005, providing the respective ontologies for public uses and allowing interaction with public via open data and communication methods via a W3C list (public-xg-ssn@w3.org) It is expected that Data-sets based on this ontology may already exist from other projects.
Open issues/ Challenges	
Tool support	

Building Information Model (BIM) Ontology

Name	Building Information Model (BIM) Ontology
Author and License	unknown license
URL	http://www.modelservers.org/public/ontologies
Description	IntUBE project (Intelligent Use of Building's Energy Information) – finished 2011 (project website no more available)
Scope (Domain)	Building
Use cases (Motivation, Relevance)	Static data about the building in general, such as building location, process stage, spaces, envelopes and building services
Data sets	
Open issues/ Challenges	see Simulation Information Model (SIM) Ontology
Tool support	

Global City Indicator Foundation Ontology

Name	Global City Indicator Foundation Ontology
Author and License	"Global City Indicators©" is a term created by the Global City Indicators Facility in 2010 at the University of Toronto. All rights apply. GCI refers to the indicators created by the GCIF to establish a global standard of over 100 city indicators with a standardized definition and methodology, tested with over 250 cities globally since 2010. The GCIs are now in a draft international standard currently being voted upon by member countries with a view to publishing the GCIs in 2013
URL	
Description	Cities are moving towards policy-making based on data. But as Hoornweg et al. ³⁰ state: "Today there are thousands of different sets of city (or urban) indicators and hundreds of agencies compiling and reviewing them. Most cities already have some degree of

³⁰ Hoornweg, D., Nunez, F., Freire, M., Palugyai, N., Herrera, E.W., and Villaveces, M., (2007), "City Indicators: Now to Nanjing", World Bank Policy Research Working Paper 4114.

	performance measurement in place. However, these indicators are usually not standardized, consistent or comparable (over time or across cities), nor do they have sufficient endorsement to be used as ongoing benchmarks.” In response to this challenge, the Global City Indicator (GCI) Facility was created by the World Bank to define a set of city indicators that can be consistently applied globally.
Scope (Domain)	city performance measurement
Use cases (Motivation, Relevance)	www.cityindicators.org
Data sets	
Open issues/ Challenges	
Tool support	

User Behavior and Building Process Information

Name	User Behavior and Building Process Information
Author and License	TU Vienna, unkown license
URL	https://www.auto.tuwien.ac.at/downloads/thinkhome/ontology/ProcessOntology.owl
Description	An ontology representing processes in Smart Home Systems.
Scope (Domain)	Occupancy, building domain
Use cases (Motivation, Relevance)	
Data sets	
Open issues/ Challenges	
Tool support	

Cadastre and Land Administration Thesaurus (CaLAtHe)

Name	Cadastre and Land Administration Thesaurus (CaLAtHe)
Author and License	Professor Erik Stubkjær, Department of Planning, Aalborg University, Denmark, Dr. Volkan Cagdas, Department of Surveying Engineering, Yildiz Technical University, Turkey. licensed under a Creative Commons Attribution-ShareAlike 3.0 Unported License
URL	http://www.cadastralvocabulary.org (available on request)
Description	This ontology provides a controlled vocabulary, which is derived mainly from the ISO/DIS 19152 Land Administration Domain Model and related to existing thesauri, primarily the GEMET thesaurus, the AGROVOC thesaurus, and the STW Thesaurus for Economics.
Scope (Domain)	Buildings, cadastre, geography
Use cases (Motivation, Relevance)	In smart cities application, it could be useful where certain buildings data are needed; e.g. geographical positioning, internal divisions (apartments), spatial representation.
Data sets	
Open issues/ Challenges	CaLAtHe is encoded as a Simple Knowledge Organization System (SKOS), according to specifications developed by the World Wide Web Consortium (W3C).
Tool support	

CASCADE airport ontology

Name	CASCADE airport ontology
Author and License	Institute Mihajlo Pupin, Sanja Vranes, Nikola Tomasevic, Marko Batic, CASCADE ICT for Energy Efficient Airports Unknown license
URL	https://webgate.ec.europa.eu/fpfis/wikis/display/eeSemantics/CASCADE+Modelling+Ontology https://webgate.ec.europa.eu/fpfis/wikis/download/attachments/44483343/CASCADE%20Core%20Airport%20Ontology%20%28class%29.owl?version=1&modificationDate=1399554858401&api=v2
Description	The CASCADE Core airport ontology provides a generic model of the airport facility as a set of concepts and corresponding relationships among them. The purpose of the Core airport ontology is to provide the modelling guidelines and to describe the technical

	characteristics/relations of related systems installed at the site, their topological profile, as well as to facilitate the interpretation of signals.
Scope (Domain)	Airports, automated buildings
Use cases (Motivation, Relevance)	Even if this ontology is oriented to create a model of airport facility, it can be used also in generic buildings modelling, particularly public buildings or complexes, due to the commonality with airport sub-functions.
Data sets	
Open issues/ Challenges	The CASCADE deontology is characterized by a partial superposition with other ontologies taken into account (regarding geography or buildings). It would be expectable to reach a
Tool support	

Nikola Tesla Airport (NTA) Ontology

Name	Nikola Tesla Airport (NTA) Ontology
Author and License	Possibly: University of Belgrade, Institute Mihajlo Pupin
URL	
Description	The ontology facilitates the interpretation and semantic enrichment of SCADA signals using the underlying spatial and topological model of the airport infrastructure as well as vendor data regarding the equipment characteristics, protocols and standards used. http://www.e-drustvo.org/icist/2012/html/pdf/495.pdf
Scope (Domain)	airport management, emergency management, facility management
Use cases (Motivation, Relevance)	“Nikola Tesla” airport Belgrade “For improving and providing more intelligent , holistic, airport facility management systems that rely on contemporary management platforms such as Supervisory Control and Data Acquisition (SCADA) systems, classification and description of various information/data within the airport infrastructure” ³¹
Data sets	

³¹ <http://www.e-drustvo.org/icist/2012/html/pdf/495.pdf>

Open issues/ Challenges	
Tool support	

Trade

Name	Trade
Author and License	Antonio Paredes-Moreno. No license information.
URI	http://personal.us.es/aparedes/Trade.owl
Description	This ontology defines the classes, properties and individuals that make up the commercial management specially focused to purchase orders, in a company dedicated primarily to trade in electrical, energy and environmental products.
Scope (Domain)	Energy trade
Use cases (Motivation, Relevance)	
Data sets	
Open issues/ Challenges	
Tool support	

Geonames Ontology

Name	GeoNames Ontology
Author and License	Bernard Vatant, GeoNames. Creative Commons CC BY 3.0
URL	http://www.geonames.org/ontology/ontology_v3.1.rdf
Description	The GeoNames Ontology makes it possible to add geospatial semantic information to the World Wide Web. All over 8.3 million geonames toponyms now have a unique URL with a

	corresponding RDF web service. Other services describe the relation between toponyms.
Scope (Domain)	Geography
Use cases (Motivation, Relevance)	Relevant to guarantee unique reference to toponyms and easy information access through the GeoNames database (http://sws.geonames.org), especially geographic position.
Data sets	At http://www.geonames.org/advanced-search.html all of the rdf produced by GeoNames are available.
Open issues/ Challenges	
Tool support	

Data Cube

Name	Vocabulary for multi-dimensional (e.g. statistical) data publishing
Author and License	Contributors: Arofan Gregory, Dave Reynolds, Ian Dickinson, Jeni Tennison, Richard Cyganiak W3C license
URL	http://www.w3.org/TR/vocab-data-cube/
Description	This vocabulary allows multi-dimensional data, such as statistics, to be published in RDF. It is based on the core information model from SDMX (Statistical Data and Metadata Exchange).
Scope (Domain)	Statistics
Use cases (Motivation, Relevance)	This vocabulary was originally developed and published outside of W3C, but has been extended and further developed within the Government Linked Data Working Group. It is aimed at people wishing to publish statistical or other multi-dimension data in RDF. The cube model is very general and so the Data Cube vocabulary can be used for various data sets such as survey data, spreadsheets and OLAP data cubes. Energy-related datasets can therefore also be used.
Data sets	Datasets are at the core of the vocabulary structure. The vocabulary defines them any collection of statistical data that corresponds to a defined structure. Different views of the data can be achieved through slicing.

Open issues/ Challenges	
Tool support	

The PROV Ontology

Name	PROV-O: The PROV Ontology
Author and License	Timothy Lebo, Satya Sahoo, Deborah McGuinness. Copyright © 2013 W3C® (MIT, ERCIM, Keio, Beihang), All Rights Reserved
URL	http://www.w3.org/ns/prov-o
Description	The PROV Ontology (PROV-O) expresses the PROV Data Model [PROV-DM] using the OWL2 Web Ontology Language (OWL2) [OWL2-OVERVIEW]. It provides a set of classes, properties, and restrictions that can be used to represent and interchange provenance information generated in different systems and under different contexts. It can also be specialized to create new classes and properties to model provenance information for different applications and domains.
Scope (Domain)	General, provenance
Use cases (Motivation, Relevance)	In smart cities case, it could be useful to classify pieces of information in terms of trust and reliability, due to the high level of integration of information by different sources
Data sets	
Open issues/ Challenges	
Tool support	

DogOnt

Name	DOGONT - Ontology Modeling for Intelligent Domotic Environments
Author and License	Dario Bonino
URL	http://www.cad.polito.it/pap/exact/iswc08.html
Description	The DogOnt ontology supports device/network independent description of houses, including both controllable and architectural elements
Scope (Domain)	Architecture
Use cases (Motivation, Relevance)	
Data sets	http://elite.polito.it/ontologies/dogont.owl
Open issues/ Challenges	
Tool support	

SUMO (Suggested Upper Merged Ontology)

Name	SUMO (Suggested Upper Merged Ontology)
Author and License	Adam Pease. License unknown.
URL	http://www.ontologyportal.org/
Description	The Standard Upper Ontology is the result of a joint effort to create a large, general-purpose, formal ontology. It is promoted by the IEEE Standard Upper Ontology working group, and its development began in May 2000. The participants were representatives of government, academia, and industry from several countries. The effort was officially approved as an IEEE standard project in December 2000.
Scope (Domain)	Top level ontology
Use cases (Motivation,	Upper level ontologies could be used for data integration across datasets

Relevance)	
Data sets	Upper level ontologies could be used in a high number of datasets as they represent top concepts
Open issues/ Challenges	Unknown
Tool support	Unknown

BOnSAI

Name	Bonsai - Smart Building Ontology for Ambient Intelligence
Author and License	Thanos G. Stavropoulos Dimitris Vrakas Danai Vlachava Nick Bassiliades No license information.
URI	http://pis.csd.auth.gr/ontologies/bonsai/BOnSAI.owl
Description	The ontology extends and benefits from existing ontologies in the field, but also adds classes needed to sufficiently model every aspect of a service-oriented smart building system. Namely, it includes concepts modeling all functionality (i.e. services, operations, inputs, outputs, logic, parameters and environmental conditions), QoS (resources, QoS parameters), hardware (smart devices, sensors and actuators, appliances, servers) users and context (user profiles, moods, location, rooms etc.). (Literally taken from https://www.researchgate.net/publication/254006761_BOnSAI_a_smart_building_ontology_for_ambient_intelligence)
Scope (Domain)	Smart buildings
Use cases (Motivation, Relevance)	The ontology is designed for the Smart IHU ambient setting whose goal is to provide automation and energy savings at the International Hellenic University (IHU) premises. This environment is equipped with sensors and actuators (so-called smart devices) in large scale, which interact with the rest of the system using the web service interface (Literally taken from https://www.researchgate.net/publication/254006761_BOnSAI_a_smart_building_ontology_for_ambient_intelligence).
Data sets	

Open issues/ Challenges	
Tool support	Smart IHU Smart Building environment

OGC GeoSPARQL

Name	OGC GeoSPARQL
Author and License	Open Geospatial Consortium No license information.
URI	http://www.opengis.net/ont/geosparql
Description	An RDF/OWL vocabulary for representing spatial information. This vocabulary is based on the effort of OGC to provide 'standard' terms in RDF for describing geographic data on the Web.
Scope (Domain)	Spatial information, Geographic information
Use cases (Motivation, Relevance)	
Data sets	
Open issues/ Challenges	
Tool support	

WGS84 Geo Positioning

Name	WGS84 Geo Positioning
Author and License	Dan Brickley, Tim Berners-Lee, Unknown
URI	http://www.w3.org/2003/01/geo/wgs84_pos
Description	A vocabulary for representing latitude, longitude and altitude information in the WGS84 geodetic reference datum.

Scope (Domain)	Geographic information
Use cases (Motivation, Relevance)	A <i>basic</i> RDF vocabulary that provides the Semantic Web community with a namespace for representing lat (itude), long (itude) and other information about spatially-located things, using WGS84 as a reference datum.
Data sets	
Open issues/ Challenges	
Tool support	

Open Street Map (OSM) ontology

Name	Open Street Map (OSM) ontology
Author and License	Unknown
URI	http://mapserv.kt.agh.edu.pl/ontologies/osm.owl
Description	The ontology defines classes of objects appearing on maps: roads, railways, water ways, amenities, emergency infrastructure, public transport, shops, tourist attractions, etc. This large ontology contains about 660 classes, which were identified based on the published set of OSM tags and their values.
Scope (Domain)	Physical features on the ground, Maps
Use cases (Motivation, Relevance)	
Data sets	
Open issues/ Challenges	Non accessible web page.
Tool support	

Places Ontology

Name	Place ontology
Author and License	Michael Smethurst Rob Styles Tom Scott Licence: CC0 Universal (http://creativecommons.org/publicdomain/zero/1.0/)
URI	http://purl.org/ontology/places
Description	The Places Ontology is a simple lightweight ontology for describing places of geographic interest.
Scope (Domain)	Places of geographic interest.
Use cases (Motivation, Relevance)	
Data sets	
Open issues/ Challenges	
Tool support	

eDIANA context awareness ontology

Name	eDIANA context awareness ontology
Author and License	Unknown
URI	http://www.owl-ontologies.com/ContextAwareness_eDIANA.owl (N.B: wrong URI in OWL file! URL:: https://sites.google.com/site/smartappliancesproject/ontologies/ediana.owl)
Description	The main objective of this ontology is to define the universe of concepts and their relations in the domain of eDIANA Platform Architecture, related to device awareness. The eDIANA Platform Architecture provides a wide and heterogeneous list of devices in hierarchical levels: MacroCell and Cell.
Scope (Domain)	Devices

Use cases (Motivation, Relevance)	
Data sets	
Open issues/ Challenges	
Tool support	

Urban Energy Ontology

Name	Urban Energy Ontology
Author and License	Apache License Version 2.0 (www.apache.org/licenses/)
URI	http://www.semanco-tools.eu/urban-energy-ontology
Description	This ontology describes the domain of urban planning based on the OWL-based translation of the Suggested Upper Merged Ontology (SUMO), available at: http://www.ontologyportal.org/ .
Scope (Domain)	Urban Planning
Use cases (Motivation, Relevance)	The SEMANCO Energy Model is a formal ontology – specified using Web Ontology Language 2 (OWL 2) – comprising concepts captured from diverse sources including standards, use cases and activity descriptions and data sources related to the domains of urban planning and energy management. In particular it contains the terms and attributes that describe regions, cities, neighbourhoods and buildings; energy consumption and CO2 emission indicators, as well as climate and socio- economic factors that influence energy consumption.
Data sets	
Open issues/ Challenges	
Tool support	

Concept Modelling Ontology (CMO)

Name	Concept Modelling Ontology (CMO)
Author and License	Michel Böhms, Peter Bonsma, Bruno Fies Unknown license
URI	http://www.modelservers.org/public/ontologies/cmo/cmo.ttl
Description	CMO is a reusable, generic ontology (also referred to as an 'upper ontology') that enables full-power, pure semantic, concept modelling
Scope (Domain)	Generic Ontology, Top level ontology
Use cases (Motivation, Relevance)	The modelling & monitoring of energy nodes in urban areas for holistic and optimized energy management within the Odysseus project. http://www.odysseus-project.eu/ The modelling & configuration of residential districts/homes for supporting Self-organized Collective Housing (CSO) in the FP7-NMP Proficient project http://www.proficient-project.eu/
Data sets	
Open issues/ Challenges	
Tool support	lfc2cmo http://www.resilient-project.eu/documents/35984/54543/2_ODYSSEUS.pdf

Registered Organization Vocabulary

Name	Registered Organization Vocabulary
Author and License	Unknown
URI	http://www.w3.org/ns/regorg
Description	This is a vocabulary for describing organizations that have gained legal entity status through a formal registration process, typically in a national or regional register. It focuses solely on such organizations and excludes natural persons, virtual organizations and other types of legal entity or 'agent' that are able to act. It is a profile of the more flexible and comprehensive Organization Ontology [ORG].
Scope (Domain)	Organization

Use cases (Motivation, Relevance)	
Data sets	
Open issues/ Challenges	
Tool support	

The Event Ontology

Name	The Event Ontology
Author and License	Yves Raimond (yves@dbtune.org), Samer Abdallah (samer.abdallah@elec.qmul.ac.uk), CC-BY Creative Commons Attribution Unported (Open) http://creativecommons.org/licenses/by/3.0/
URI	http://purl.org/NET/c4dm/event.owl
Description	The event ontology deals with the notion of reified events. It defines one main Event concept. An event may have a location, a time, active agents, factors and products, as depicted below.
Scope (Domain)	Event, time
Use cases (Motivation, Relevance)	
Data sets	Use of the ontology in other domains: <ul style="list-style-type: none"> • glastonbury-2011 • linked-open-data-of-ecology • rdfize-lastfm • rkb-explorerer-webscience
Open issues/ Challenges	
Tool support	

km4city

Name	km4city
Author and License	paolo nesi (paolo.nesi@unifi.it) http://www.disit.dinfo.unifi.it , CC-BY-SA Creative Commons Attribution-ShareAlike Unported (Open) http://creativecommons.org/licenses/by-sa/3.0/
URI	http://www.disit.org/km4city/schema
Description	To interconnect the data provided by the Tuscany Region, the Open Data of the City of Florence, and the other Static and Real Time dataset, we started to develop a Knowledge Model, that allows to collect all the data coming from the city, related to mobility, statistics, street graph, sensors, cultural heritage, parkings, weather, services, energy, events.
Scope (Domain)	geographic locations, transportation, city, sensors, cultural heritage, services, parkings, weather, events, public structures
Use cases (Motivation, Relevance)	No use case defined, but demo mapping applications.
Data sets	This project published the transportation data for the city of Florence and geographic data for the Tuscani region (Italy) : http://log.disit.org/
Open issues/ Challenges	The information is difficult to find in a web site consisting of one page with criptic URIs.
Tool support	Tools and slides: http://www.disit.org/6056 documentation ENG: http://www.disit.org/5606 related to version 1.1 of the ontology documentation ITA: http://www.disit.org/6461 of version 1.4 of the ontology image: http://www.disit.org/6507 of version 1.4 of the ontology ontology .. the OWL and triple version http://www.disit.org/6506 mobile demonstrator. http://LOG.disit.org graph can be used to browse the knowledge model of Smart City, just an example of a Florence segment. http://log.disit.org/service/?graph=71de8caef449ed56143aa95c8c8266ab From that, you can see the whole DISIT knowledge knowledge model for Florence, based on Km4City ontology. Link at Service Map tool: http://servicemap.disit.org API of Servicemap http://www.disit.org/6597 open source mobile tool: http://www.disit.org/659 Service Map tool: http://servicemap.disit.org a tool for developers to pose geographic queries (learn and generate code queries in an esy manner) and see the knowledge base produced by the harvesting process

Internet of Things (IoT) Ontology

Name	Internet of Things (IoT) Ontology
Author and License	Konstantinos Kotis, Unknown

URI	http://purl.org/loT/iot
Description	Internet of Things (IoT) Ontology is a reference ontology for data integration and semantic coordination of smart entities. The aim of the ontology is to provide a clear understanding of the new research domain of IoT in respect to the need for 'true' (i.e. semantic) interoperability of smart entities and other kind of entities (control, physical) that may be plugged in it anytime, by anyone and from anyplace. The objective is not to focus in sensor and observation data descriptions as in SSN ontology, but instead to emphasize the notion of interconnected, clustered and aligned smart entities towards supporting their semantic registration, coordination and retrieval in a Web of Things.
Scope (Domain)	Internet of Things, Web of Things
Use cases (Motivation, Relevance)	
Data sets	
Open issues/ Challenges	
Tool support	

OpenIoT Ontology

Name	OpenIoT Ontology
Author and License	http://myr.altevista.org/foaf.rdf#me , W3C software license (Open) http://www.w3.org/Consortium/Legal/2002/copyright-software-20021231
URI	http://openiot.eu/ontology/ns/
Description	This ontology describes abstraction of sensors and their integration with cloud computing concepts. This ontology is developed by DERI (http://www.deri.ie) for the OpenIoT project (http://openiot.eu). It is based on the alignment among the W3C Semantic Sensor Networks Incubator Group (SSN-XG) ontology, the SPITFIRE ontology and the LSM vocabulary.
Scope (Domain)	Sensors, Cloud Computing
Use cases (Motivation, Relevance)	

Data sets	
Open issues/ Challenges	
Tool support	

SPITFIRE Ontology

Name	SPITFIRE Ontology
Author and License	http://myr.altervista.org/foaf.rdf#me , Alexandre Passant, W3C software license (Open) http://www.w3.org/Consortium/Legal/2002/copyright-software-20021231
URI	http://spitfire-project.eu/ontology/ns/
Description	This ontology describes sensors, observations, and related concepts. It also describes events and their correlations. The final aim is to support a better description of sensor context. This ontology is developed by DERI (http://www.deri.ie) for the SPITFIRE project (http://spitfire-project.eu). It is based on the alignment among the W3C Semantic Sensor Networks Incubator Group (SSN-XG) ontology, the Dolce-DnS Ultralite ontology and the Event Model F ontology.
Scope (Domain)	Sensors
Use cases (Motivation, Relevance)	https://www.itm.uni-luebeck.de/files/1213/6973/3906/IEEEComMag.pdf
Data sets	
Open issues/ Challenges	<p>“As it was difficult to foresee the wealth of current Web applications back when the Web was created, we have to wait and see how people will use the Semantic Web of Things. It is also hard to predict if a Semantic Web of Things will be as broadly adopted as the Web is today.</p> <p>One indicator is that LOD has already achieved significant uptake by governments (including UK, USA), the media sector (BBC), life sciences, geo information systems, and Web companies (Freebase). Making sensor data part of this data pool is clearly beneficial as then integration with knowledge from arbitrary sources is possible. For example, sensors and their data can be linked to geographic data (correlated natural phenomena), user-generated data (social feedback), government data (census information), life-science data (causes and effects of diseases), etc.”</p> <p>Source: https://www.itm.uni-luebeck.de/files/1213/6973/3906/IEEEComMag.pdf, 2015</p>

Tool support	
--------------	--

Eurobau Utility Ontology

Name	Eurobau Utility Ontology
Author and License	CC-BY Creative Commons Attribution Unported (Open) http://creativecommons.org/licenses/by/3.0/
URI	http://semantic.eurobau.com/eurobau-utility.owl
Description	The Eurobau Utility Ontology provides utility elements for describing building materials and respective offerings from the Eurobau semantic dataspace. This ontology defines a few extensions to GoodRelations.
Scope (Domain)	Building Materials
Use cases (Motivation, Relevance)	BauDataWeb is one of the largest and richest public datasets for a well-defined vertical sector that is available on the Semantic Web. It covers a major share of the European market. It covers a major share of the European market.
Data sets	81 Manufacturers / Brands 19 Reseller 183 Warehouse locations 56.360 Product Models (including variants) 56.360 Product Models (including variants) 1.783.798 Offerings 95 % of the product models include rich FreeClassOWL descriptions
Open issues/ Challenges	Unkown
Tool support	Any SPARQL endpoint SPARQL queries via the OpenLink Software Virtuoso repositories at http://lod.openlinksw.com/sparql and http://linkeddata.uriburner.com/sparql

FreeClassOWL Ontology

Name	FreeClassOWL Ontology
Author and License	CC-BY Creative Commons Attribution Unported (Open) http://creativecommons.org/licenses/by/3.0/
URI	http://www.freeclass.eu/freeclass_v1.owl
Description	The FreeClass Ontology for construction and building materials and services provides classes and properties for describing products and services from the building and construction industry. It is derived from the free classification standard freeClass. For more information, see http://www.freeclass.eu/ . The conversion of this ontology has been funded by the Österreichische Forschungsförderungsgesellschaft GmbH (FFG) and the Bundesministerium für Verkehr, Innovation und Technologie (BMVIT) under the FIT-IT Semantic Systems project 'myOntology' (contract number 812515). For describing the commercial aspects of respective offerings, please use the GoodRelations ontology. The FreeClassOWL Ontology is a GoodRelations-compliant ontology for describing construction and building materials and services.
Scope (Domain)	Building Materials
Use cases (Motivation, Relevance)	
Data sets	N/A
Open issues/ Challenges	
Tool support	FreeClass Semantic Search for Construction Materials: Online tool for demonstrating how the usage of Semantic Web technologies can improve a search for building and construction materials

CERISE CIM Profile for Smart Grids

Name	CERISE CIM Profile for Smart Grids
Author and License	TNO: Maarten Steen Unknown license
URI	http://ns.cerise-project.nl/energy/def/cim-smartgrid
Description	A Profile of the IEC Common Information Model (CIM) for Smart Grids, developed by the Cerise-SG project

Scope (Domain)	Smart Grids
Use cases (Motivation, Relevance)	<p>Interoperability with a special interest in the information exchanges between smart grids and their surroundings. Creation of future proof and efficient information exchange between the energy sector, eGovernment and geo-world. It is not realistic to assume that these worlds can be easily adjusted given the mass behind it. Our approach covers two levels: technical (web services, exchange formats, protocols) and content (semantics, information models). In case of model mismatches between the different worlds, semantic model transformation services are developed.</p> <p>More specifically the following use cases have been analysed:</p> <ul style="list-style-type: none"> - Information is exchanged within a crisis management scenario dealing with the effects of a flood on the power grid. Due to sector-interdependent effects during this disaster data sharing is essential for successful crisis management; - Energy Balancing Information Facility for facilitating the administrative balancing in a smart grid
Data sets	
Open issues/ Challenges	<p>Laura Daniele [17-07-2015]: This is a draft version for internal use in the CERISE project. We encountered some issues with the generation this OWL profile with the CIMTool that still need to be solved. One issue is that the mapping of cardinalities in the transformation from UML to OWL is not always correct. For example: • the UML association Meter [0..1] was mapped by the CIMTool into the OWL property MeterReading.Meter exactly 1, while we would expect it to be mapped to MeterReading.Meter max 1 • the UML association Readings [0..*] was mapped by the CIMTool into the OWL property MeterReading.Readings min 1, while while we would expect it to be mapped to MeterReading.Readings min 0 To overcome the issue we are changing manually the incorrect cardinalities in the generated OWL profile, but there are many properties and this requires quite some time and effort, so some cardinalities can still be not compliant with the original UML model. Roel Stap[12-06-2015]: For gas metering the class SimpleEndDeviceFunction is defined, specialisation of EndDeviceFunction. Within this class there is a mandatory attribute defined "kind" of type EndDeviceFunctionKind. This last class is an enumeration of different type of metering. This class can be used can be used to distinguish between different tupe of metering, for example electric and gas metering. This means this class is mandatory, for each type of metering the type shall be defined.</p>
Tool support	Created with TopBraid Composer

COINS Building Information Model (CBIM)

Name	COINS Building Information Model (CBIM)
Author and License	The COINS system is a publication of the COINS programme, represented by CUR Bouw & Infra, Gouda.

	The COINS system is an open standard. The contents of the standard are freely available. Reuse of the standard is not subject to any restrictions.
URI	http://www.coinsweb.nl/c-bim.owl
Description	<p>COINS is an open BIM standard. It is complementary to standards issued by buildingSMART such as IFC, IFD Library and IDM. COINS supports the exchange of Systems Engineering information and ensures that an object tree, GIS data, 2D drawings, 3D models, IFC models and object type library can be stored in association in a database. It also provides a BIM-container interchange format. It is used by partners in building construction projects for the purpose of exchanging building information and managing building information.</p> <p>The first edition was published in 2010 as COINS 1.0. A first update was released as COINS 1.1 in December 2014.</p>
Scope (Domain)	Buildings / Exchange of building information and management of building information
Use cases (Motivation, Relevance)	<p>COINS is not describing use case but what they called “Reference frameworks”. A Reference frameworks intended as industry standards will be made available dealing with the specific issues mentioned below:</p> <ul style="list-style-type: none"> • Functional specification (available) • Preparing a Design Dossier • Transferring building information • Object data management • Preparing the object structure • Testing a functional spatial schedule of requirements • Making quantity estimates (available) • Applying a library • Using construction sector libraries • Managing a building configuration
Data sets	N/A
Open issues/ Challenges	For the moment, only 2 reference frameworks are under development.
Tool support	<p>The COINS Navigator is a reference implementation to demonstrate the principles that lie at the bottom of the COINS standardization development. The application has the following features:</p> <ul style="list-style-type: none"> • creating a C-BIM model • editing all aspects of a C-BIM model • loading/saving a C-BIM model • importing/exporting a COINS Container • simulate a COINS Building Information System (CBIS) • demonstrate the COINS version management system • merging C-BIM models

	<ul style="list-style-type: none"> • report generation in Excel or HTML format • switch between layer view and object tree view • build and link to COINS object libraries • link to external object libraries (CROW Cheobs, BuildingSMART IFD Library, ETIM) • specify and checking a Window of Authorization • link and visualize IFC models and/or PMO models • import planning data from Primavera of MSPProject • link with the VISI building management data standard (under development) <p>The COINS Navigator can freely be downloaded, used and further distributed.</p>
--	--

CASCADE Fiumicino Airport ontology

Name	CASCADE Fiumicino Airport ontology
Author and License	Institute Mihajlo Pupin: Sanja Vranes, Nikola Tomasevic, Marko Batic Unknown license
URI	http://jpo.imp.bg.ac.rs/cascade/airport-ontology/FCO/airportOntologyFCO_TBox.owl
Description	A full-blown ontology model of Fiumicino airport (Rome, Italy) which models a specific airport infrastructure by classifying installed technical systems relevant to the energy management aspect. It was developed by extension and population of the CASCADE Generic Facility ontology. Fiumicino airport (Rome, Italy) model (TBox) developed within EU FP7 CASCADE project
Scope (Domain)	facility management, operation, monitoring and controlling, devices/sensors
Use cases (Motivation, Relevance)	Ontologies used as part of a framework to reduce energy in airports is of particular interest because of the potential these types of buildings have. Airports consume as much energy as small cities. With successful demonstration at Fiumicino airport in Rome, the solution can be replicated in other airports around Europe, leading to potentially enormous energy savings and CO ₂ emissions reduction.
Data sets	Apart from airport-internal private datasets from the Fiumicino airport, there are no other datasets that currently make use of the ontology.
Open issues/ Challenges	
Tool support	Created with TopBraid Composer

CASCADE Malpensa Airport ontology

Name	CASCADE Malpensa Airport ontology
Author and License	Institute Mihajlo Pupin: Sanja Vranes, Nikola Tomasevic, Marko Batic Unknown license
URI	http://jpo.imp.bg.ac.rs/cascade/airport-ontology/MXP/airportOntologyMXP_TBox.owl
Description	A full-blown ontology model of Malpensa airport (Milan, Italy) which models a specific airport infrastructure by classifying installed technical systems relevant to the energy management aspect. It was developed by extension and population of the CASCADE Generic Facility ontology. Malpensa airport (Milan, Italy) model (TBox) developed within EU FP7 CASCADE project.
Scope (Domain)	Airports
Use cases (Motivation, Relevance)	Even if this ontology is oriented to create a model of airport facility, it can be used also in generic buildings modelling, particularly public buildings or complexes, due to the commonality with airport sub-functions.
Data sets	
Open issues/ Challenges	The CASCADE deontology is characterized by a partial superposition with other ontologies taken into account (regarding geography or buildings).
Tool support	Created with TopBraid Composer

Energy in Buildings Ontology

Name	Energy in Buildings Ontology (EiBO)
Author and License	info@planergy.it , Unknown
URI	http://www.planergy.it/file/EiBO_v1.owl
Description	<p>The ontology developed in Planergy allow the semantic description of the phenomena inherent energy flows incoming and outgoing from a set of buildings immersed in their environment, by formally allowing the description of :</p> <ul style="list-style-type: none"> - the physical spaces (buildings and other sub objects) - the properties belonging to these physical spaces - the functionalities needed to support monitoring and measurement activities - the description of processes (administrative and economic) - the human presence in the spaces and their allocation

	- the terms used in different region to describe these spaces
Scope (Domain)	physical space, monitoring, measurement, roles, regions
Use cases (Motivation, Relevance)	It has been developed to support the administration in publishing open data related to energy performances of public buildings in Italy. It should foster the development of PPP with ESCOs
Data sets	
Open issues/ Challenges	
Tool support	The ontology is available in plain OWL

INERTIA Ontology

Name	INERTIA Ontology
Author and License	Peter Kostelnik, peter.kostelnik@gmail.com, All rights reserved / no license (No Open)
URI	http://www.inertia-project.eu/inertia/files/document/ontologies/inertia-schema.n3
Description	Ontology contains information describing the whole domain required for INERTIA pilot applications. Ontology serves as the common vocabulary used across all software components, but also serves as flexible support of describing and accessing all information and static data used in required by application logic of INERTIA pilots. Ontology describes whole location context, taxonomy of devices (Distributed Energy Resources, sensors, actuators) and occupancy model
Scope (Domain)	Location context, models of devices, occupancy model.
Use cases (Motivation, Relevance)	<p>Based on semantic middleware prototype requirements, the design and development of INERTIA ontologies focuses mostly on the semantic model of BIM, IoTDevices and DER modelling.</p> <p>The Middleware is required to have access and control over different subsystems within the Local Hub. The main roles of the Semantic Based Middleware are to provide:</p> <ul style="list-style-type: none"> • real-time information regarding a building's (or cluster of buildings') infrastructure and equipment • dynamic control over specific DERs <p>Most use cases involve access to real-time information and/or dynamic control, either directly or indirectly through usage of historical databases of past events.</p> <p>Regarding explicit use of real-time data, the Inertia's Middleware is involved as a major</p>

	<p>component supporting UC 1 – Monitoring of Local Hub’s Energy Data, UC 4 – Monitoring of personalized energy data and UC 2 – Automated real time control planning of the facility infrastructure based on contextual information , providing a continues stream of data about energy usage and contextual information from sensors and DERs in combination with descriptive data stemming from INERTIA ontologies.</p> <p>The Middleware will also allow the INERTIA system to use real time building occupancy detection from motion sensors and other contextual information that can be used as part of the background data for the spatio temporal occupancy flow models required for UC 3 – Automated real time control on building’s DERs based on occupancy and scheduling information .</p> <p>The ability to control DERs such as HVAC and lighting from the Aggregator level is an integral part of in particular UC 10 – End user control of local Hub Portfolio .</p> <p>http://www.inertia-project.eu/inertia/files/document/deliverables/INERTIA_Deliverable_D3.1.pdf</p>
Data sets	Example Dataset: http://www.inertia-project.eu/inertia/files/document/ontologies/event-dump.n3
Open issues/ Challenges	Unkown
Tool support	Via N3/RDF

INSPIRE Data Specification on Transport Networks

Name	INSPIRE Data Specification on Transport Networks
Author and License	Unknown
URI	http://cui.unige.ch/isi/onto/inspire-TN
Description	INSPIRE Data Specification on Transport Networks in OWL
Scope (Domain)	Transport
Use cases (Motivation, Relevance)	<p><i>Transport Networks</i> is defined within the INSPIRE Feature Concept Dictionary as:</p> <p>“The transport component should comprise an integrated transport network, and related features, that are seamless within each national border. In accordance with article 10.2 of the Directive, national transport networks may also be seamless at European level, i.e. connected at national borders. Transportation data includes topographic features related to transport by road, rail, water, and air. It is important that the features form net works where appropriate, and t hat links between different networks are established, i.e. multi-modal nodes, especially at the local level, in order to satisfy the requirements for intelligent transport systems such as location based services (LBS) and telematics. The transport</p>

	<p>network should also support the referencing of transport flow to enable our navigation services.”</p> <p>[INSPIRE Feature Concept Dictionary]</p> <p>http://inspire.ec.europa.eu/documents/Data_Specifications/INSPIRE_DataSpecification_TN_v3.0.pdf</p>
Data sets	
Open issues/ Challenges	
Tool support	

CityGML Ontology

Name	CityGML Ontology
Author and License	Unknown
URI	http://cui.unige.ch/citygml/2.0/
Description	This OWL version of the CityGML standard has been created by (a) generating classes, properties and axioms from the CityGML 2 XML Schemas, (b) manually fixing some generation problems, (c) manually replacing every reference to gml:xxxPropertyType by references to xxx, and (d) manually adding missing gml: classes, properties, and axioms for the geometry profile of CityGML
Scope (Domain)	City
Use cases (Motivation, Relevance)	
Data sets	
Open issues/ Challenges	
Tool support	

URBAMET Thesaurus

Name	URBAMET Thesaurus
Author and License	The urbamet association. No license, the Thesaurus is not available as OWL file.
URI	http://notx.documentation.developpement-durable.gouv.fr/Urbanisme/thesaurus/navigation.xhtml
Description	<p>The URBANDATA Association is a consortium of urban information providers in European countries. It aims to improve the international exchange and dissemination of information about urban issues and to develop new products and services which will aid those processes.</p> <p>URBANDATA publishes the database website URBADOC which contains over 700,000 records of the literature on urban and social research, policy and practice in the countries of its five members and elsewhere.</p> <p>The French chapter of URBANDATA (the French association “urbamet”) has produced a Thesaurus which can be consulted on-line.</p>
Scope (Domain)	<p>The main subjects covered are:</p> <ul style="list-style-type: none"> • Land management • Urban management • Architecture • Local government • Environment • Community facilities and amenities • Local finance • Urban infrastructure services • Housing • Pollution and conservation • Urban transportation
Use cases (Motivation, Relevance)	URBAMET is primarily intended for town planners, local elected representatives, architects and urban development professionals, as well as researchers and students, librarians and documentalists, etc
Data sets	The last two years of the databank are available with free access on this site. URBAMET can also be consulted on the Urbadoc web site, alongside the 6 other European databanks addressing these issues.
Open issues/ Challenges	Still to be converted into OWL...

Tool support	N/A
--------------	-----

SAREF: the Smart Appliances REFerence ontology

Name	SAREF: the Smart Appliances REFerence ontology
Author and License	Laura Daniele (laura.daniele@tno.nl), Unknown
URI	http://ontology.tno.nl/saref
Description	<p>The Smart Appliances REFerence (SAREF) ontology is a shared model of consensus that facilitates the matching of existing assets (standards/protocols/datamodels/etc.) in the smart appliances domain. The SAREF ontology provides building blocks that allow separation and recombination of different parts of the ontology depending on specific needs. The starting point of SAREF is the concept of device (e.g., a switch). Devices are tangible objects designed to accomplish a particular task in households, common public buildings or offices. In order to accomplish this task, the device performs one or more functions. For example, a washing machine is designed to wash (task) and to accomplish this task it performs the start and stop function. The SAREF ontology offers a list of basic functions that can be eventually combined in order to have more complex functions in a single device. For example, a switch offers an actuating function of type 'switching on/off'. Each function has some associated commands, which can also be picked up as building blocks from a list. For example, the 'switching on/of' is associated with the commands 'switch on', 'switch off' and 'toggle'. Depending on the function(s) it accomplishes, a device can be found in some corresponding states that are also listed as building blocks. When connected to a network, a device offers a service, which is a representation of a function to a network that makes the function discoverable, registerable and remotely controllable by other devices in the network. A service can represent one or more functions. A service is offered by a device that wants (a certain set of) its function(s) to be discoverable, registerable, remotely controllable by other devices in the network. A service must specify the device that is offering the service, the function(s) to be represented, and the (input and output) parameters necessary to operate the service. A device in the SAREF ontology is also characterized by an energy/power profile that can be used to optimize the energy efficiency in a home or office that are part of a building.</p>
Scope (Domain)	Smart Appliances, Devices, Sensors, Actuators, Device functions, Services attached with devices
Use cases (Motivation, Relevance)	<p>The Smart Appliances REFerence (SAREF) ontology is conceived as a shared model of consensus that facilitates the matching of existing assets in the smart appliances domain, reducing the effort of translating from one asset to another, since the SAREF ontology requires one set of mappings to each asset, instead of a dedicated set of mappings for each pair of assets. Using the SAREF ontology, different assets can keep using their own terminology and data models, but still can relate to each other through their common semantics. In other words, the SAREF ontology enables semantic interoperability in the smart appliances domain.</p>

	<p>The ontology is based on the fundamental principles of reuse and alignment of concepts and relationships that are defined in existing assets, modularity to allow separation and recombination of different parts of the ontology depending on specific needs, extensibility to allow further growth of the ontology, and maintainability to facilitate the process of identifying and correcting defects, accommodate new requirements, and cope with changes in (parts of) the SAREF ontology.</p> <p>The ontology mainly addresses the consumer (mass) market of the home, private dwellings, but also common public buildings and offices, and the standard appliances used in that environment.</p> <p>The appliances covered by SAREF ontology are:</p> <ul style="list-style-type: none"> • Home and buildings sensors (temperature, humidity, energy meters, environmental sensors etc.) and actuators (windows, doors,). Sensors belonging to appliances are treated individually. • White goods, namely, rinsing and cleaning, cooking and baking, refrigerating and freezing, vacuum cleaning, washing and drying as well. • HVAC; heating, ventilation, air conditioning • Lighting
Data sets	<p>The Smart Appliances reference (SAREF) ontology can be used to match the data from different organizations.</p> <p>Example of instances: saref_sampledata.ttl</p> <p>available at http://ontology.tno.nl/saref_sampledata (click on “Individuals” in the Navigation tab on the top right corner to visualize the sample data)</p> <p>download at http://ontology.tno.nl/saref_sampledata.ttl</p>
Open issues/ Challenges	<p>The SAREF ontology has been mapped on the ETSI M2M Architecture³², and found that there is a good correlation between the ETSI M2M Architecture and SAREF’s function-related device categories. The mapping with energy-related and building-related device categories is still minimal. For further implementation of SAREF into ETSI M2M, the SAREF ontology needs to be extended with ETSI M2M specific functionality, such as M2M Gateway, and Remote Management functionality.</p>
Tool support	<p>The SAREF ontology is expressed in RDF/OWL and serialized in Turtle (therefore, the file extension .ttl), which is a compact syntax alternative to RDF/XML. Thus, the ontology can be opened with any ontology editor, such as TopBraid Composer, Protégé and NeOn.</p>

³² <http://www.etsi.org/technologies-clusters/technologies/m2m>

DECT ULE ontology

Name	DECT ULE ontology
Author and License	TNO: Jasper Roes, Frank den Hartog, Laura Daniele, Jack Verhoosel Unknown license
URI	https://sites.google.com/site/smartappliancesproject/ontologies/dect_ule-ontology
Description	<p>The DECT ULE ontology describes the DECT ULE HF standard, which is based on a star network topology of network entities. A HFNetworkEntity can be a HFConcentrator, which is the network's master device, or a HFDevice. There are up to thousands of devices supported by the concentrator and connected to it. The HF protocol supports several types of HF messages exchanged between network entities (i.e., commands, requests, responses), and each of these messages has a message type code. A HFMessage is structured in 3 fields (i.e., network, transport and application layers).</p> <p>It considers home, private dwellings, but also common public buildings and offices, and the standard appliances used in that environment. Elevators and other special equipment are not covered.</p>
Scope (Domain)	DECT ULE HF standard; Star network topology; HF protocol;
Use cases (Motivation, Relevance)	<p>The study covers the following interoperability use cases for Smart Appliances:</p> <ul style="list-style-type: none"> - Interoperability with construction design tools (product information, product performance and product behaviour) - Interoperability with Facility Management and Energy Management Systems - Interoperability with Building Control systems - ESCO (Energy Services) systems - Interoperability with the Smart Grid
Data sets	
Open issues/ Challenges	<p>Challenges:</p> <ul style="list-style-type: none"> - Proposal for a unified ontology to be contributed to ETSI for consideration as a future standard. - Documentation of the proposed the ontology into the ETSI M2M architecture.
Tool support	

Echonet ontology

Name	Echonet ontology
Author and License	TNO (adaptation from the ECHONET consortium specification) in the frame of the Smart Appliances Study (2013/0077), License of the specification is “open to the public” only for versions 1.0 and 1.01
URI	https://sites.google.com/site/smartappliancesproject/ontologies/echonet-ontology
Description	The Echonet ontology represents Echonet device objects and their properties (Echonet: Energy Conservation and HOMecare NETwork (ECHONET) for Device Objects). A Device defines one or more DeviceObject. Device objects represent mechanical functions of a device and aim at facilitating controls and status verification through communications between devices. There are general properties applicable to any device object, such as hasOperationStatus. These general properties are defined as sub properties of the hasDeviceObjectProperty property.
Scope (Domain)	Echonet device objects, Echonet device properties, device mechanical functions, controls and status verification, device communication
Use cases (Motivation, Relevance)	Energy Conservation and homecare network for Device Objects.
Data sets	
Open issues/ Challenges	
Tool support	

EnOcean ontology

Name	EnOcean: EnOcean Alliance Equipment Profile (EEP)
Author and License	Laura Daniele (laura.daniele@tno.nl), Unknown
URI	https://sites.google.com/site/smartappliancesproject/ontologies/enoccean-ontology
Description	EnOcean ³³ is a company that develops energy harvesting wireless sensors which are claimed to be maintenance free and flexible allowing cost reduction in buildings and industrial facilities. In 2012 this technology has subsequently been standardized as

³³ www.enoccean.com

	<p>ISO/IEC 14543-3-10. Full interoperability is guaranteed together with the EnOcean Equipment Profiles (EEPs) drawn up by the EnOcean Alliance³⁴.</p> <p>The EnOcean Equipment Profile (EEP) contains information about devices “enabled by EnOcean”, including RORG (identifies the EnOcean Radio Protocol (ERP) radio telegram type), FUNC (identifies the basic functionality of the data content), and TYPE (identifies the type of device in its individual characteristics).</p> <p>The EnOcean ontology specifies the user data embedded in the structure of a radio telegram as defined by the EnOcean Equipment Profile (EEP). Therefore, the ontology defines an EEP_profile class. Through the hasElement property, the EEP_profile class is characterized by 3 elements:</p> <p>the RORG class, which represents the ERP radio telegram type using a code, for example, the value F6 represents an RPS telegram type;</p> <p>the FUNC class, which represents the basic functionality of the data contained in a radio telegram, for example, TemperatureSensor, AutomatedMeterReading, Detector, and HVAC_component;</p> <p>and the TYPE class, which represents the specific characteristics of a device type, for example, a temperature sensor with range between -10°C and 30°C (TemperatureSensor_range10Cto30C class)</p> <p>The ontology defines 4 types of telegrams according to the EEP profile, namely RPS, 1BS, 4BS and VLD, which are represented by the corresponding classes TelegramRPS, Telegram1BS, Telegram4BS, and TelegramVLD, respectively. Each telegram has a RORG (hasRORG property), and can have several device functions (hasFUNC property) and types (hasTYPE property). Each RORG class, FUNC class and TYPE class has a code (hasRorgCode property, hasFuncCode property and hasTypeCode property, respectively). These codes are used to assemble the 3 field code that characterizes a specific telegram.</p>
Scope (Domain)	EnOcean, Equipment Profile, EEP, Device Types, Device Function, Sensors Function
Use cases (Motivation, Relevance)	The ontology could be utilized to model any EnOcean device/sensor/actuator under a common framework.
Data sets	-
Open issues/ Challenges	<p>The TYPES are defined completely for the TelegramRPS and Telegram1BS classes. For the Telegram4BS class the TYPES are defined until and including the A5_10 subclass. For the TelegramVLD class the TYPES are not defined at all. For completeness, it is advised to add the remaining TYPES in the future.</p> <p>The EEP document³⁵, which was used as a reference for the ontology, defines enumerations that are used to further characterize the specific TYPE of telegrams. These</p>

³⁴ www.enocean-alliance.org

	<p>enumerations are too many and too detailed to be included in the current version of the ontology. However, the ontology could be extended in the future to cover also this aspect of the EnOcean Equipment Profile.</p> <p>The source used to create the ontology is a secured pdf from which the information could not be automatically copied. As a consequence, comments that could better explain the telegrams are missing in the ontology.</p>
Tool support	The EnOcean ontology is expressed in RDF/OWL and serialized in Turtle (therefore, the file extension .ttl), which is a compact syntax alternative to RDF/XML. Thus, the ontology can be opened with any ontology editor, such as TopBraid Composer, Protégé and NeOn.

FAN FPAI ontology

Name	FAN FPAI ontology
Author and License	Unknown
URI	https://sites.google.com/site/smartappliancesproject/ontologies/fan-ontology
Description	The Fanpai ontology describes the resources (appliances) used in the Flexible Power Application Infrastructure (FPAI) . These resources are defined in the Resource Abstraction Interface (RAI class), which is used to express the energetic flexibility that appliances can offer and how this flexibility should be exploited. The RAI is an interface layer between: the Resource Abstraction Layer (RAL class) that monitors and controls the appliances and knows how much flexibility they can offer. The RAL consists of two main components: the resource manager (ResourceManager class) and the resource driver (not considered in this ontology); the energy apps (EnergyApp class) that are typically provided by a third party and exploit the flexibility that appliances have to offer. An energy app is only interested in exploiting energetic flexibility and not in the details of a specific appliance, such as a washing machine, for instance.
Scope (Domain)	appliances, household appliances, Flexible Power Application Infrastructure, FPAI
Use cases (Motivation, Relevance)	
Data sets	

³⁵ <http://www.enocean-alliance.org/eep/>

Open issues/ Challenges	
Tool support	

FIEMSER ontology

Name	Friendly Intelligent Energy Management Systems in Residential Buildings Data Model
Author and License	Laura Daniele (laura.daniele@tno.nl), Juan Pérez Project Coordinator (juan.perez@tecnalia.com), Unknown
URI	https://sites.google.com/site/smartappliancesproject/ontologies/fiemser-ontology
Description	<p>The Fiemser ontology describes the main classes of the Energy-focused BIM model and WSN-related data that are part of the FIEMSER data model. The ontology describes the building space organization in terms of the Building, BuildingPartition, BuildingSpace and BuildingZone classes. A building partition defines a part of a building managed by either a dweller (e.g., a flat) or a facility manager (e.g., a common building area). A building space defines the physical spaces of the building. A building zone defines a functional area in the building that will be controlled as a unique zone. A building consistsOf some building partitions, a building partition consistsOf some building spaces, a building zone consistsOf some building spaces. The Fiemser ontology also describes the devices (Device class) used in the building in terms of HomeEquipment and ControlledDevice.</p> <p>A HomeEquipment is any home appliance or mechanism to increase building energy efficiency, such as Generator, Load, Mechanism and Storage. Generators represent devices that provide part of the energy required by the building, for example, PV (of type ElectricalGenerator) and Boiler (of type ThermalGenerator). Loads represent devices that consume energy and offer a service to the user, for example, TV (of type ElectricalLoad) and Radiator (of type ThermalLoad). Mechanisms represent devices that are installed in the home to increase its energy efficiency, but don not generate or consume energy by themselves, for example, a Blinder. Storage devices represent devices that store energy and can be used to provide convenient energy management strategy, for example, Battery (of type ElectricalStorage) and Tank (of type ThermalStorage).</p> <p>A ControlDevice represents a device directly connected to the FIEMSER control infrastructure and used to monitor and/or control the environment and its appliances. A control device consistsOf some ControlComponent that can be a hardware component (Sensor or Actuator or CommDevice) and a software component. An Actuator is any actuating hardware installed in a control device, such as a Dimmer, Switch and Controller. A Sensor can be a MeasurementSensor (e.g., thermostat) or StateSensor (e.g., presence). A communication device (CommComponent) identifies the communication devices used for data exchange and uses a specific Network protocol (NetProtocol class).</p>
Scope (Domain)	BIM, WSN, Building space description, Climate, Location, Devices, Devices in a building, Energy Consumption, Home Usage Profile, Price, Device Schedule

<p>Use cases (Motivation, Relevance)</p>	<p>FIEMSER FP7 European R&D project's³⁶ objective was the development of an innovative energy management system for existing and new residential buildings, which pursues the increase of the efficiency of the energy used and the reduction of the global energy demand of the building, but without penalizing the comfort levels of the users.</p> <p>The core motivation is the minimization of the energy demand from external resources and the management of local energy consumption/production/storage.</p> <p>Since special emphasis was given on the interoperability with architectural CAD tools and building energy simulation tools, the gbXML data model was selected as reference data model for the FIEMSER development.</p>
<p>Data sets</p>	<p>The specific sub-models used to create the FIEMSER data model belong to the following corresponding categories of data: Environmental and Contextual data (ENV), Energy-focused Building Information Model (BIM), Data from sensors (WSN), User Preferences (USR), Resources scheduling data (SCH), Advices (ADV), Energy Performance Indicators (EPI), and User access right (RGH).</p>
<p>Open issues/ Challenges</p>	<p>The Fiemser ontology describes the main classes of the Energy-focused BIM model and WSN-related data that are part of the FIEMSER data model. Although also the other 6 models of the FIEMSER data model contain relevant information, it was not possible to include them in the current version of the ontology. It is therefore advised to do so as part of future work.</p> <p>The source used to create the ontology is a secured pdf from which the information could not be automatically copied. As a consequence, comments that could better explain the ontology may be missing.</p>
<p>Tool support</p>	<p>The FIEMSER ontology is expressed in RDF/OWL and serialized in Turtle (therefore, the file extension .ttl), which is a compact syntax alternative to RDF/XML. Thus, the ontology can be opened with any ontology editor, such as TopBraid Composer, Protégé and NeOn.</p>

FIPA Device Ontology

<p>Name</p>	<p>FIPA Device Ontology: Foundation for Intelligent Physical Agents BDevice Ontology Specification</p>
<p>Author and License</p>	<p>Laura Daniele (laura.daniele@tno.nl), gateways@fipa.org, All rights reserved / no license (No Open)</p>
<p>URI</p>	<p>https://sites.google.com/site/smartappliancesproject/ontologies/fipa.ttl</p>
<p>Description</p>	<p>In 2002, the then existing FIPA Gateways TC published an ontology for describing devices and their properties.</p> <p>The FIPA ontology describes a device ontology that aims at enabling interoperability</p>

³⁶ www.fiemser.eu

	<p>between software agents, as defined by the FIPA Device Ontology Specification. This ontology can be used by agents when communicating about devices: when agents pass profiles of devices to each other, these profiles can be validated using the information contained in this ontology.</p> <p>The main class of the ontology is the Device class, which defines a device and its general properties. A device has some InfoDescription, such as the name, vendor and version of the product under consideration, and has some hardware and software properties. Software properties include the details of the device’s operating system (hasOperatingSystem), such as its name, vendor and version. Hardware properties are the type of connection that the device uses (hasConnection), the amount of memory that it requires (hasMemory), the user interfaces offered by the device (hasUserInterface), and the type of central processing unit (hasCPU). The connection type is expressed in terms of name, vendor and version of the connection provider (hasConnectionInfo). The MemoryTypeDescription class defines the unit of measure of the memory (hasMemoryUnit), and its usage type, namely application, storage, or both application and storage (hasMemoryUsageType). The UIDescription class defines the information that characterize the screen of the device (hasScreen), such as its width (hasWidth), height (hasHeight), resolution (hasResolution), and the measurement units (hasWidthHeightUnit). The ontology also defines the RequestDeviceInfo function that can be used in the FIPA framework by an agent to make a query to request the device information contained in the ontology.</p>
Scope (Domain)	Device, Device interoperability, Device description, Profile, Software agents,
Use cases (Motivation, Relevance)	The FIPA ontology can be used by agents when communicating about devices. Agents pass profiles of devices to each other and validate them against the FIPA ontology. The profiles come in handy for example in a situation where memory- or processing-intensive actions take place; agent A1 can ask agent A2 whether device D has enough capabilities to handle some task A1 has in mind.
Data sets	-
Open issues/ Challenges	The OWL version of the FIPA ontology has been created according to the FIPA device ontology specification ³⁷ . This specification refers to some classes defined in other FIPA ontologies, namely the FIPA-Nomadic-Application and FIPA-Agent-Management ontologies. These ontologies have not been translated to OWL. However, the Fipa ontology can be extended to consider the FIPA-Nomadic-Application by using the AgentPlatform class, and the FIPA-Agent-Management ontologies by using the QoS class.
Tool support	The FIPA ontology is expressed in RDF/OWL and serialized in Turtle (therefore, the file extension .ttl), which is a compact syntax alternative to RDF/XML. Thus, the ontology can be opened with any ontology editor, such as TopBraid Composer, Protégé and NeOn.

³⁷ <http://www.fipa.org/specs/fipa00091/SI00091E.html>

Hydra Basic Device Information ontology

Name	HYDRA ontology: Heterogeneous physical devices in a distributed architecture ontology
Author and License	Dr. Markus Eisenhauer Project Coordinator (markus.eisenhauer@fit.fraunhofer.de), Unknown
URI	https://sites.google.com/site/smartappliancesproject/ontologies/hydra-ontology
Description	<p>Although there are several ontologies developed in the Hydra project, the Hydra Basic Device Information ontology has been included consisting of the following modules: i) Basic Device Information, ii) Device Services, iii) Device Events, iv) Device Malfunctions, v) Device Capabilities and vi) State Machine.</p> <p>The Basic Device Information module represents general device information. The HydraDevice is the main ontology class, which is further divided in the PhysicalDevice and the SemanticDevice classes. Physical and semantic devices share common device properties, such as deviceId or inLocation, but have different semantic interpretation and behaviour. The HydraDevice class refers to the InfoDescription class using the info property. The InfoDescription class contains basic information about device friendlyName, manufacturer data, i.e., manufacturerName and manufacturerURL, and device model data, i.e., modelName, modelDescription and modelNumber. An important part of the basic device information is the representation of device type modelled as sub classes of the PhysicalDevice concept, such as SensorDevice, ActuatorDevice, MediaDevice and MobileDevice. Further, the hasEmbeddedDevice property of the SemanticDevice class recursively refers to HydraDevice concept. This property enables the creation of models of composite devices, such as in case of the HeatingSystem device, which can be, for example, composed of Thermometer and Pump devices.</p>
Scope (Domain)	Physical device, Device information, Device Modelling, Device Services, Device Malfunctions
Use cases (Motivation, Relevance)	HYDRA aims to interconnect devices, people, terminals, buildings, etc., not only providing interoperability at a syntactic level, but also at a semantic level. Hydra relies on semantic descriptions/annotations to expose device capabilities (using ontologies) so that applications can understand these capabilities and use them.
Data sets	-
Open issues/ Challenges	<p>The proposed Hydra device services model represents one possible approach to service modelling and may be subject to further investigation and research related to possible existing and future semantic service mark-up standards (such as WSMO) and the system architecture requirements.</p> <p>Ontology changes can be caused from user requirements on changes to structure and classification; in Hydra this would be the developer users' requirements. The changes can also be induced by changes in the underlying domain objects being modelled by the ontology, in Hydra; this would be changes in device capabilities, in security protocols etc.</p>
Tool support	The ontology can be opened with any ontology editor, such as TopBraid Composer,

	Protégé and NeOn.
--	-------------------

SmartCoDE ontology

Name	SmartCoDE ontology
Author and License	, Unknown
URI	https://sites.google.com/site/smartappliancesproject/ontologies/smartcode-ontology
Description	The Smartcode ontology presents a classification of Energy using Products (EuPs) into seven categories, namely variable services (VAR SVC class), thermal services (THM SVC class), schedulable services (SCD SVC class), event-timeout services (ETO SVC class), charge control (CHA CON class), complete control (COM CON class), and custom control (CUS CON class). These products have some parameters, such as Configuration, OnlineInput and SensorInput. Each product is characterized by an energy management strategy (hasEnergyManagementStrategy property) and its cost profile can be of interest of not for energy management purposes (isCostProfileInteresting property).
Scope (Domain)	Energy, classification of energy products, energy measurement
Use cases (Motivation, Relevance)	
Data sets	
Open issues/ Challenges	
Tool support	

Mirabel ontology

Name	Mirabel ontology
Author and License	SAP AG's MIRABEL team is led by Dr. Gregor Hackenbroich, whose main research interests concern the management of structured and unstructured data as well as the integration of events into business software, and by Dr. Henrike Berthold, whose main interests lie on Business Intelligence and modern architectures for data management systems. http://www.mirabel-project.eu/ (no other contact info), All rights reserved / no license (No Open)
URI	https://sites.google.com/site/smartappliancesproject/ontologies/mirabel-ontology

Description	The Mirabel ontology defines how actors can express their energy flexibility for a specific device with respect to amount, time and price in user preferences. Each device has an energy profile that describes the amount of energy consumed and/or produced over a time span. A flex offer is issued by an actor and combines the user preferences with the corresponding device energy profile.
Scope (Domain)	actors, energy flexibility, user preferences, energy profile, energy flexibility
Use cases (Motivation, Relevance)	This ontology gives a semantically better view on the flexibility concept and its meaning in relation to the building on the one hand and the smart grid on the other hand. Moreover, this ontology forms the basis for a vocabulary that can be published via the web and used to connect IT systems from various stakeholders in the energy domain that handle supply and demand of energy.
Data sets	
Open issues/ Challenges	EU project result. Still maintained?
Tool support	

Stream Annotation Ontology – SAO

Name	Stream Annotation Ontology - SAO
Author and License	Institute for Communication System, University of Surrey: Sefki Kolozali http://creativecommons.org/licenses/by/3.0/
URI	http://iot.ee.surrey.ac.uk/citypulse/ontologies/sao/sao.rdf
Description	aims to semantically represent the features of a stream data. It allows publishing content-derived data about IoT streams and provides concepts such as StreamData, Segment, StreamAnalysis on top of the TimeLine concepts. Timeline Ontology extends OWL-Time with various timelines (e.g.\ universal or discrete), temporal concepts, such as Instant, and Interval, and interval relationships. The SAO uses the broad definition of the StreamEvent concept in order to express an artificial classification of a time region, corresponding to a particular stream data. It also extends the sensor observations described in SSN Ontology <code>ssn:Observation</code> through a concept, <code>StreamData</code> , that allows to describe <code>Segment</code> or <code>Point</code> linked to time intervals or time instants. Below is the depiction of the workflow of the SAO Ontology.
Scope (Domain)	Internet of Things, stream data
Use cases (Motivation,	Representing IoT data streams is an important requirement in semantic stream data

Relevance)	<p>applications, as well as in knowledge-based environments for Smart Cities.</p> <p>The project had identified 101 smart city scenarios and related use cases (http://www.ict-citypulse.eu/scenarios/) in cooperation with partner cities and city cooperation (City Stakeholder Group) and derived a set of requirements for a smart city framework based on proposed use cases, references in the field and “on site” workshops together with city partners.</p>
Data sets	
Open issues/ Challenges	
Tool support	

Adapt4EE Ontology

Name	Adapt4EE Ontology
Author and License	Dr. Dimitrios Tzovaras Project Coordinator (Dimitrios.Tzovaras@iti.gr), Unknown
URI	http://www.adapt4ee.eu/adapt4ee/results/ontologies.html
Description	<p>The Adapt4EE³⁸ ontology constitutes a formal model for enterprise energy performance measuring, monitoring and optimization. Adapt4EE semantic enterprise model treats, learns and manages the enterprise environment as an intelligent agent, perceives environmental state using multi-type sensors and information modalities. The Adapt4EE Data Model incorporates business processes and occupancy data. I</p> <p>The TTL files of the overall Adapt4EE Ontology have been utilized for the scope of the Adapt4EE project. The files include: Adapt4EE Building Information Model (BIM) Adapt4EE Business Process Model (BPM) Adapt4EE Common Information Model Adapt4EE Device Model Adapt4EE Event Model Adapt4EE KPI Model Adapt4EE Occupancy Model Adapt4EE Units Mode.</p>
Scope (Domain)	BIM, BPM, Device, Events, Occupancy, Building Automation, Building Performance optimization, energy efficiency
Use cases (Motivation, Relevance)	<p>The Adapt4EE Enterprise Models allow for the proactive identification of optimum local adaptations of enterprise utility operations, based on predictions of possible occupancy patterns and respective business operations and energy profiles.</p> <p>The semantic coverage and subsequently the potential usage of the ontology is partially</p>

³⁸ www.adapt4ee.eu

	overlapping with the results from the HYDRA project.
Data sets	The model has been calibrated during the training phase based on sensor data captured during operation and then applied and evaluated in real-life every day enterprise operations
Open issues/ Challenges	-
Tool support	The Adapt4EE ontology is serialized in Turtle (therefore, the file extension .ttl), which is a compact syntax alternative to RDF/XML. Thus, the ontology can be opened with any ontology editor, such as TopBraid Composer, Protégé and NeOn.

ROUTE - Route Ontology of Urban Transportation Entities

Name	ROUTE - Route Ontology of Urban Transportation Entities
Author and License	Diarmuid Ryan (diarmuid.ryan@ucdconnect.ie), Achilleas Psyllidis (A.Psullidis@tudelft.nl), Oudom Kem (oudom.kem@emse.fr), Matthew Horrigan (matthew.horrigan@ucdconnect.ie), CC By 3.0
URL	http://labs.geodata.gov.gr/en/dataset/urban-transportation-routes-athens
Description	This ROUTE ontology describes public urban transportation routes. It also describes concepts pertinent to trip services, pickup and drop-off types, time intervals, frequency, geographical information about stops, among other related concepts.
Scope (Domain)	Athens, services, bus stops, stop times, transportation network
Use cases (Motivation, Relevance)	Athens, services, bus stops, stop times, transportation network
Statistics	None provided
Questions	Available as a zip file

9 Collected datasets

9.1 Gap analysis

The availability of open linked data related to energy in general is scarce. There are some online portals offering relevant data which is largely not open (e.g. data from *Eurostat*), and of which only a small part specifically addresses the energy domain. Such example is www.engagedata.eu which offers some 253 datasets tagged with the keyword 'energy', however, a closer inspection reveals that not all data is in an open format (e.g. *rdf*) or freely available, with some of the provided links leading to data with restricted access. Similarly, www.publicdata.eu has more than a thousand hits relating to energy, the majority of them provided in formats like *xls*, *csv* and *html*.

Popular portals such as www.datahub.io also offer a variety of datasets that are potentially interesting for Ready4SmartCities, but only a few of them are open (a general energy-related search returned ca. 630 results, of which only 12 were *rdf+xml*, and 7 *api/sparql*).

A portal concentrated solely on offering open linked data online and for free is hitherto not available to our knowledge. www.smartcity.linkeddata.es is the first of its kind that offers linked open datasets with immediate overview of their availability, form, license, etc. However, due to the lack of organizations publishing their data as linked and open, the catalogue experiences slow growth in terms of new content being uploaded on the website. Feedback through the online survey used to screen for new datasets is rare, and the involvement of the community identified in WP1 seems to be harder compared to ontologies. Possible ways to increase interest and participation with respect to datasets are discussed in Part C *Conclusions*.

The most relevant data for this project seems to be resulting from different initiatives/projects, such as the *Energy efficiency assessments and improvements* dataset, a comprehensive dataset that demonstrates the power of linked open data by covering assessments from Sweden and the US. Of the identified datasets, *Linked Clean Energy Data* is perhaps the most comprehensive, as it covers domains such as policy and regulatory country profiles, key stakeholders, project outcome documents, thesaurus, renewables, energy efficiency, climate change.

With 18 datasets it is impossible to perform a meaningful analysis due to the low number of datasets. The aim is to identify data that belongs to domains not yet covered in order to achieve certain diversity and make recommendations with regards to datasets for Energy Measurement and Validation.

Specifically for the domain of energy management systems interoperability, there are high demands regarding security and privacy issues. Also, there are rather complex data structures and a huge amount of data so that it seems that there is a natural barrier for publishing data on the web. In that respect, there are still a lot of open questions to be discussed and solved. Additionally, there is still a lack of clear business cases for data owners to open their data and to justify additional efforts to transfer and host the data in the web. All these circumstances might explain why there is only very few open linked data available. In general, found datasets are either results of research projects or somehow driven by public authorities. From industry a natural interest is driven by marketing use cases, i.e. provision of open data to advertise their products. Accordingly, they typically focus on unique selling features instead of providing neutral and comparable product descriptions.

Our preliminary conclusion about availability of open datasets in the area of Energy Management Systems and Energy Measurement and Validation is quite disappointing. The following section summarizes the result of our research and, not claiming to give a complete picture of the current situation, it shows the challenges of providing a critical mass of data to be a sound basis to build new applications or point of information.

9.2 List of datasets

The European Building and Construction Materials Database for the Semantic Web

Name	The European Building and Construction Materials Database for the Semantic Web
Author and License	Andreas Radinger, Martin Hepp, Otto Handle unknown license (data mapped from the Eurobau database available at http://eurobau.com/)
URL	http://semantic.eurobau.com/sitemap.xml (for fetching all data) http://semantic.eurobau.com/eurobau-utility.owl (ontology) http://linkeddata.uriburner.com/sparql (public SPARQL endpoint) http://eurobau.com/ (source)
Description	Major dataset of the European building and construction materials market for the Semantic Web on the basis of the GoodRelations Web Vocabulary for E-Commerce. (see http://semantic.eurobau.com/)
Scope (Domain)	Construction Materials
Use cases (Motivation, Relevance)	Comparison of products? Search for products
Statistics	81 Manufacturers / Brands 19 Resellers 183 Warehouse locations 56.360 Product types (including variants) 1.783.798 Offerings 95 % of the product models include rich FreeClassOWL descriptions
Questions	

Daily Global Weather Measurements, 1929-2009 (NCDC, GSOD)

Name	Daily Global Weather Measurements, 1929-2009 (NCDC, GSOD)
Author and License	National Climate Data Center (NCDC) unknown license
URL	http://aws.amazon.com/datasets/Climate/2759 ;

	http://www7.ncdc.noaa.gov/CDO/cdoselect.cmd?datasetabbv=GSOD&countryabbv=&georegionabbv=
Description	A collection of daily weather measurements (temperature, wind speed, humidity, pressure, &c.) from 9000+ weather stations around the world. Historical data are generally available for 1929 to the present, with data from 1973 to the present being the most complete.
Scope (Domain)	Climate
Use cases (Motivation, Relevance)	The US National Climatic Data Center has been collecting weather data at stations around the globe since 1929. In particular, the Global Summary of the Day contains samples of surface weather data like rainfall, temperature, wind speed, etc.
Statistics	9000+ monitored weather stations ca. 20 field names with types (integer, float, boolean) and description (e.g. measurement – miles, Fahrenheit, milibars, knots, inches)
Questions	The dataset can only be used within the United States. The bulk data is quite large (20GB) and is therefore not quickly obtainable/downloadable. A demo/snippet of the data would be helpful for organisations seeking to explore and make use of it.

Repener building energy

Name	Repener building energy
Author and License	Álvaro Sicilia et.al. Creative Commons Attribution
URL	http://arcdev.housing.salle.url.edu/repener/sparql
Description	Integrated information of the Spanish territory, regarding energy certification, building monitoring, and geographical data
Scope (Domain)	energy efficiency, energy certification
Use cases (Motivation, Relevance)	
Data sets	
Open issues/ Challenges	
Tool support	

Enipedia

Name	Enipedia
Author and License	TU Delft
URL	http://enipedia.tudelft.nl/wiki/Main_Page
Description	Enipedia is an active exploration into the applications of wikis and the semantic web for energy and industry issues. Through this we seek to create a collaborative environment for discussion, while also providing the tools that allow for data from different sources to be connected, queried, and visualized from different perspectives.
Scope (Domain)	energy and industry issues
Use cases (Motivation, Relevance)	
Data sets	http://enipedia.tudelft.nl/wiki/Special:SparqlExtension
Open issues/ Challenges	
Tool support	

Linked Clean Energy Data

Name	Linked Clean Energy Data
Author and License	Florian Bauer, Renewable energy & energy efficiency partnership, http://www.reeep.org/ OGL license (UK Open Government License)
URL	www.reeegle.info/downloads/latest_reeegle_dump.nt
Description	A comprehensive set of linked clean energy data on several domains.
Scope (Domain)	Policy and regulatory country profiles, key stakeholders, project outcome documents, thesaurus, renewables, energy efficiency, climate change
Use cases (Motivation, Relevance)	Apart from helpful documentation like project outcomes and a thesaurus, the data give insight into other domains relevant to the work in Ready4SmartCities, such as stakeholders, as well as climate data. Energy efficient measures that meet the regulations and policies of the respective country also need to be taken into consideration when

	planning any energy efficiency related activities.
Statistics	
Questions	

State Energy Data System (SEDS)

Name	State Energy Data System (SEDS)
Author and License	U.S. Energy Information Administration (EIA) unknown license The data collected by EIA surveys forms (http://www.eia.gov/survey/) are for the most part not proprietary and available. For users eager to dive deeper there are assembled tools to access searchable databases.
URL	Assembled tools are available to customize searches, view specific data sets, study detailed documentation, and access time-series data. <ul style="list-style-type: none"> • http://api.eia.gov/ Application Programming Interface (API) is a machine readable format which can serve all customers for free, though a registration key is needed for access. (For further information see: http://www.eia.gov/developer/) • http://www.eia.gov/beta/api/bulkfiles.cfm The bulk download facility provides the entire contents of each major API data set in a single ZIP file. • http://www.eia.gov/tools/models/datatools.cfm Additional set of data tools for exploiting data from different domains.
Description	The State Energy Data System (SEDS) is the source of the U.S. Energy Information Administration's (EIA) comprehensive state energy statistics. SEDS is aimed to create historical time series of energy production, consumption, prices, and expenditures by state for analysis and forecasting purposes. (For further information see: http://www.eia.gov/state/seds/)
Scope (Domain)	Consumption, Prices and Expenditures, Production
Use cases (Motivation, Relevance)	There are many use cases for smart cities where energy data system is of relevance: <ul style="list-style-type: none"> • Historical time series of energy production / consumption, prices and expenditures • Energy Analysis • Exploitation of data for prediction purposes
Statistics	408,000 electricity series organized into 29,000 categories 30,000 State Energy Data System series organized into 600 categories

	<p>115,052 petroleum series and associated categories</p> <p>11,989 natural gas series and associated categories</p> <p>132,331 coal series and associated categories (released Feb 25, 2014)</p> <p>3,872 Short-Term Energy Outlook series and associated categories (released May 27, 2014)</p> <p>368,466 Annual Energy Outlook series and associated categories (released May 27, 2014)</p>
Questions	
Name	State Energy Data System (SEDS)

Energy efficiency assessments and improvements

Name	Energy efficiency assessments and improvements
Author and License	Department of Energy http://www.eia.gov/consumption unknown license
URL	data-gov.tw.rpi.edu/raw/10/data-10.nt.gz
Description	<p>This is a linked dataset (in RDF) for demonstrating the power of linked data, through linking data about energy efficiency assessments from Sweden and the US. Additionally, the dataset links to other linked data sources in Sweden, such as the SNI-codes and LKF-datasets from Statistics Sweden (SCB).</p> <p>The data itself is constructed by transforming and re-publishing parts of three existing open datasets; results from the PFE and EKC projects at the Swedish Energy Agency, and the IAC assessment and recommendation database.</p>
Scope (Domain)	Energy efficiency assessment, measures for energy efficiency improvements, saved energy, cost
Use cases (Motivation, Relevance)	The dataset contains information primarily about suggested (and/or implemented) measures for energy efficiency improvements, including data about the amount of energy saved, costs involved, the nature of the improvement and measure taken, as well as basic information of the assessed organisation.
Statistics	
Questions	

Residential Energy Consumption Survey

Name	Residential Energy Consumption Survey
Author and License	Department of Energy CC-BY-SA Creative Commons Attribution-ShareAlike Unported (Open)
URL	http://www.eia.gov/consumption/
Description	Survey (RECS), which is conducted every four years, provides national statistical survey data on the use of energy in residential housing units including physical housing unit types, appliances utilized, demographics, fuels, and other energy use information. This dataset (i.e., the full RECS dataset) is very large in size and may require specialized software to open on your computer
Scope (Domain)	Residential energy consumption data , energy consumption , energy use , Household use of energy , data , federal data download , national , housing , appliances , RECS data , energy , federal datasets , energy data , statistics
Use cases (Motivation, Relevance)	
Statistics	
Questions	

Housing market indicators

Name	Housing Market Indicators
Author and License	ODC@communities.gsi.gov.uk, http://www.nationalarchives.gov.uk/doc/open-government-licence/
URL	http://opendatacommunities.org/data.rdf
Description	A dataset of indicators of the state of the UK housing market, including affordability, ownership and supply, Right to Buy, dwelling sock, empty homes, housing waiting lists, net supply and tenure
Scope (Domain)	housing market, indicators,
Use cases (Motivation, Relevance)	Public and open access to local data in UK.

Statistics	<p>20 datasets listed:</p> <ol style="list-style-type: none"> 1. Administrative geography – discontinued: 342730 triples 2. Additional Affordable Dwellings: 222720 triples 3. Domestic Energy Performance Certificates Lodged on Register - By Floor Area: 80370 triples 4. Council Tax Band D Average: 22592 triples 5. Domestic Energy Performance Certificates Lodged on Register - By Energy Efficiency Rating: 500080 triples 6. Domestic Energy Performance Certificates Lodged on Register - By Environmental Impact Rating: 500080 triples 7. Civil Parish Council Tax Level Data: 467334 triples 8. Council Tax Requirement: 234200 triples 9. Council Tax Chargeable Dwellings: 21296 triples 10. Dev - Local Authorities: 79152 triples 11. Dev - Local Authority Buildings: 3520 triples 12. Dev - Local Authority Services: 363435 triples 13. Duty owed, but no accommodation secured: no information about triples 14. Enterprise Zones: 4110 triples 15. Fire Authorities: 444 triples 16. Collection of council tax and non-domestic rates: 198816 triples 17. Average weekly social rent of new PRP general needs lettings, 2012/2013, England, District By Number of Bedrooms: 12728 triples 18. Administrative geography: 3535460 triples 19. Administrative geography data from Ordnance Survey: 53799 triples 20. Council Tax Estimated Collection Rate: 11979 triples
Questions	

INERTIA Ontology dataset instance

Name	INERTIA Ontology dataset instance
Author and License	Peter Kostelnik (peter.kostelnik@gmail.com), Creative Commons Attribution-NonCommercial 2.0 Generic (CC BY-NC 2.0)
URL	http://www.inertia-project.eu/inertia/files/document/ontologies/dataset-iti-building.n3
Description	Complete ontology instance used in 2nd year project review. Dataset describes whole location context for pilot building together with device equipment. More specifically, the data selected to be published comprise of a set of event-based data collected during one representative day from the multi-sensorial infrastructure deployed at the main INERTIA project's pilot site (a tertiary building with offices and a kitchen at CERTH premises in Thessaloniki, Greece).
Scope (Domain)	Location context, models of devices, consumption data, environmental data, occupancy model

Use cases (Motivation, Relevance)	<p>The dataset example which is publicly available can be utilized as a simple instantiation for the INERTIA ontology.³⁹</p> <p>In general, the data produced during the whole pilot implementation in CERTH premises include real-time and event-based information about distributed energy resources (DERs) consumption behaviour, environmental conditions inside and outside the pilot (temperature, humidity etc.), applied and automated control actions in the DERs as well as building occupants, and group-based and individual detection (RFID-Radio Frequency Identification detection system). The event-based data are recorded towards optimal and automated decision making in real-time without compromising users needs and comfort.</p>
Statistics	<p>The event-based dataset selected provides a representative example of events generated during one day: 2014-12-03. The dataset contains 97507 sensor events (environmental sensors, power consumption sensors, device actuators, etc.) available as semantic information.</p>
Questions	-

Number of dwellings by tenure and district in the UK

Name	Number of dwellings by tenure and district in the UK
Author and License	contactus@communities.gsi.gov.uk, Unknown
URL	http://opendatacommunities.org/data/housing-market/dwelling-stock/tenure
Description	<p>This dataset covers the years 2009 to 2013 and shows district level information with a tenure breakdown between local authority, Private Registered Providers (PRPs, formerly known as Housing Associations or Registered Social Landlords), other public sector and private sector. Figures for 2012 and 2013 are provisional. Private Registered Provider stock Information on PRP stock prior to 2012 comes from the Tenant Services Authority (TSA) Regulatory and Statistical Return (RSR). From April 2012, the TSA has become part of the Homes and Communities Agency (HCA) and information on PRP stock is now published in their annual Statistical Data Return (SDR). The SDR (and the RSR in the past) is completed by all PRPs every year in one of two variants; with PRPs owning or managing fewer than 1000 properties completing a shorter, less detailed form than those owning or managing 1000 or more properties. Other public sector dwellings ‘Other’ public sector dwellings follow the Census definition of a dwelling and include dwellings owned by any public sector body other than lower-tier local authorities (district councils, unitary authorities, metropolitan district councils and London boroughs) or Private Registered Providers (housing associations). This category includes dwellings owned by government departments (e.g. Ministry of Defence) and other public sector agencies (e.g. the NHS, the Forestry Commission, the Prison Service or county councils). Please note that it includes dwellings that are vacant even if they are scheduled for demolition at a future date. Private</p>

³⁹ <http://www.inertia-project.eu/inertia/files/document/ontologies/inertia-schema.n3>

	sector stock Private sector stock is split into owner-occupied (OO) and private rental sector (PRS). There is no direct measure of either of these tenures due to the difficulty of collecting this private information and the relatively fluid interchange between these two parts of the private dwelling stock. The current methodology calculates an estimate of the PRS using information from the Labour Force Survey (LFS) and English Housing Survey (EHS). This data was derived from Table 100, available for download as an Excel spreadsheet. For fuller information please see the 'Dwelling Stock Estimates:2013, England' statistical release available in PDF format.
Scope (Domain)	towns, cities, dwellings, government, UK, national
Use cases (Motivation, Relevance)	Public and open access to local data in UK.
Statistics	68538 triples
Questions	

Impact indicator: energy efficiency of new build housing in the UK

Name	Impact indicator: energy efficiency of new build housing in the UK
Author and License	Department for Communities and Local Government http://opendatacommunities.org/data/transparency/impact-indicators/energy-efficiency-new-builds License: OGL http://www.nationalarchives.gov.uk/doc/open-government-licence/version/2/
URL	http://opendatacommunities.org/data.rdf
Description	Average Standard Assessment Procedure energy rating score. How the figure is calculated: The sum of SAP energy rating scores for each new home for which an energy performance certificate has been issued in the reporting period, divided by the number of new homes for which a certificate has been issued. It is the average of the large number of scores calculated for new dwellings during the reporting period. Why is this indicator in the business plan? This is a key housing measure for which DCLG has policy responsibility. It monitors the energy efficiency of new build homes. How often is it updated? Quarterly Where does the data come from? National Energy Performance Certificate Register. Published figures are available here. What area does the headline figure cover? England Are further breakdowns of the data available? Yes, can be split by dwelling type. What does a change in this indicator show? An increase in this indicator would show an average increase in the energy efficiency of new homes. The average SAP rating is expected to gradually rise over the long-term as a growing proportion of new homes are completed to the 2010 Building Regulations standard, which requires more energy efficient new homes. Time Lag. Published within two months of the end of the reporting period. Next available update. To be confirmed. Type of Data. Official Statistics. Robustness and data limitations.

	Average figures are volatile due to a number of factors including the small number of new homes being assessed, the mix of dwelling types, the mix of heating systems used in new developments and the location of those developments. Links to Further Information https://www.gov.uk/government/organisations/department-for-communities-and-local-government/series/code-for-sustainable-homes-statistics#publications Contact Details CorporatePerformance@communities.gsi.gov.uk
Scope (Domain)	energy efficiency, housing, new buildings, impact indicator
Use cases (Motivation, Relevance)	<p>The sum of SAP energy rating scores for each new home for which an energy performance certificate has been issued in the reporting period, divided by the number of new homes for which a certificate has been issued. It is the average of the large number of scores calculated for new dwellings during the reporting period.</p> <p>An increase in this indicator would show an average increase in the energy efficiency of new homes. The average SAP rating is expected to gradually rise over the long-term as a growing proportion of new homes are completed to the 2010 Building Regulations standard, which requires more energy efficient new homes.</p>
Statistics	Data (from England) comes from National Energy Performance Certificate Register.
Questions	

Vehicle Traffic Data, Provided by City of Aarhus in Denmark

Name	Vehicle Traffic Data, Provided by City of Aarhus in Denmark
Author and License	Daniel Puschmann Centre for Communication Systems Research (CCSR) University of Surrey, UK email: d.puschmann@surrey.ac.uk , Unknown
URL	http://iot.ee.surrey.ac.uk:8080/datasets.html#traffic
Description	A collection of datasets of vehicle traffic, observed between two points for a set duration of time over a period of 6 months (449 observation points in total), a CityPulse EU FP7 project initiative.
Scope (Domain)	traffic data, sensor measurements, temperature conditions, location nodes
Use cases (Motivation, Relevance)	Traffic monitoring for the purposes of the CityPulse EU FP7 project.
Statistics	The data is available in raw (CSV) and semantically annotated format (RDF Triple Language Turtle format) and the whole dataset consists of 3 batches depicting the different time periods of traffic data collection, while each one of them can be downloaded separately.

	<p>Batch 1: February 2014 - June 2014 http://iot.ee.surrey.ac.uk:8080/datasets/traffic/traffic_feb_june/index.html</p> <p>Batch 2: August 2014 - September 2014 http://iot.ee.surrey.ac.uk:8080/datasets/traffic/traffic_june_sep/index.html</p> <p>Batch 3: October 2014 - November 2014 http://iot.ee.surrey.ac.uk:8080/datasets/traffic/traffic_oct_nov/index.html</p> <p>Metadata for Observation Points and Cross-observation point data are provided.</p>
Questions	Vehicle Traffic Data, Provided by City of Aarhus in Denmark

Parking Data Stream, Provided by City of Aarhus in Denmark

Name	Parking Data Stream, Provided by City of Aarhus in Denmark
Author and License	Daniel Puschmann Centre for Communication Systems Research (CCSR) University of Surrey, UK email: d.puschmann@surrey.ac.uk,, CC-BY Creative Commons Attribution Unported (Open) http://creativecommons.org/licenses/by/4.0/
URL	http://iot.ee.surrey.ac.uk:8080/datasets.html#parking
Description	A datastream with parking data provided from the city of Aarhus.
Scope (Domain)	parking data, transportation data, parking lots
Use cases (Motivation, Relevance)	Parking monitoring for the purposes of the CityPulse EU FP7 project.
Statistics	There are a total of 8 parking lots providing information over a period of 6 months (55.264 data points in total). Data selected from May 22nd 2014 - November 4th 2014.
Questions	Available as CVS and Turtle

Pollution Data, Provided by City of Aarhus in Denmark

Name	Pollution Data, Provided by City of Aarhus in Denmark
Author and License	Daniel Puschmann Centre for Communication Systems Research (CCSR) University of Surrey, UK (d.puschmann@surrey.ac.uk), CC-BY Creative Commons Attribution Unported (Open) http://creativecommons.org/licenses/by/4.0/

URL	http://iot.ee.surrey.ac.uk:8080/datasets/pollution/index.html
Description	<p>Pollution datastreams from the city of Århus from August to October 2014. This dataset includes simulation data of one sensor for each of the traffic sensor at the exact location of this traffic sensor. Pollution values are provided for carbon_monoxide, nitrogen_dioxide, sulfure_dioxide, particulate_matter and ozone index levels according to http://en.wikipedia.org/wiki/Air_Pollution_Index. For the pollution mockup stream one sensor has been simulated for each of the traffic sensor at the exact location of this traffic sensor. The data is measured using Air Quality Index⁴⁰ metric (449 observation points in total). The data is available in raw (CSV) and semantically annotated format using the citypulse information model.</p> <p>The stream generation works as follows: each sensor measurement (e.g. carbon dioxide) is initially assigned a value between 25 and 100. Every 5 minutes, the values will be updated as follows:</p> <p>if the value was below 20 before, it will now be the last value + random integer between 1 and 10</p> <p>if the value was higher than 210, it will now be the last value - random integer between 1 and 10</p> <p>else the value will be last value + a random integer between -5 and 5</p> <p>This way the measurements do not erratically jump between low and high values and represent a more realistic stream but still won't go out of bounds (unrealistically low or high values)</p>
Scope (Domain)	air pollution data, environmental values, sensor measurements, city pollution, location nodes, citypulse
Use cases (Motivation, Relevance)	The CityPulse webpage ⁴¹ offers a number of semantically annotated datasets collected from partners of the CityPulse EU FP7 project and relevant resources for smart city data. Visitors and potential stakeholders can use the menu on the left to access these resources.
Statistics	August 2014 - October 2014 generated data (not real measurements) 449 observation points in total
Questions	-

Weather Data, Provided by City of Aarhus in Denmark

Name	Weather Data, Provided by City of Aarhus in Denmark
Author and	Daniel Puschmann Centre for Communication Systems Research (CCSR) University of

⁴⁰ http://en.wikipedia.org/wiki/Air_Pollution_Index

⁴¹ <http://iot.ee.surrey.ac.uk:8080/index.html>

License	Surrey, UK (d.puschmann@surrey.ac.uk), CC-BY Creative Commons Attribution Unported (Open) http://creativecommons.org/licenses/by/4.0/
URL	http://iot.ee.surrey.ac.uk:8080/datasets.html#weather
Description	A collection of datasets of weather observations from the city of Aarhus. Collected measurements from February 2014 - June 2014 and August 2014 - September 2014. Weather data values: Dew point in degrees Celsius, Humidity (percentage), Pressure in mBar, Temperature in degrees Celsius, Wind direction in degrees, Wind speed in kilometers per hour (kph)
Scope (Domain)	weather data, environmental values, Dew point, Humidity, Pressure, Temperature, Wind direction, Wind speed, location nodes
Use cases (Motivation, Relevance)	The CityPulse webpage ⁴² offers a number of semantically annotated datasets collected from partners of the CityPulse EU FP7 project and relevant resources for smart city data. Visitors and potential stakeholders can use the menu on the left to access these resources.
Statistics	February 2014 - June 2014 and August 2014 - September 2014
Questions	-

Energy time-series mapping from University of Southampton

Name	Energy time-series mapping from University of Southampton
Author and License	J.Barker@soton.ac.uk, Open Government Licence: http://www.nationalarchives.gov.uk/doc/open-government-licence/version/2/
URL	http://data.southampton.ac.uk/dataset/energy-time-series-map
Description	This dataset maps buildings to their energy use time-series. Some buildings may have multiple time series, some are shared between two buildings. This data is provided by the role of Energy Manager in the BEMS team in buildings and estates.
Scope (Domain)	energy time-series map
Use cases (Motivation, Relevance)	Open data portal development, university of Southampton
Statistics	146 triples

⁴² <http://iot.ee.surrey.ac.uk:8080/index.html>

Questions	
-----------	--

Linked geodata dataset

Name	Linked geodata dataset
Author and License	AKSW research group from Universität Leipzig. Open Database License (ODbL) : http://opendatacommons.org/licenses/odbl/1.0/
URL	http://linkedgeodata.org/ and http://linkedgeodata.org/Datasets
Description	The data set comprises all the Open Street Map data converted in RDF. It uses the Igdo ontology for describing data extracted from Open Street Map. It is accessible through REST, SPARQL end points, dumps and be navigated through a specific map layout. The data is interlinked with DBpedia and Geo Names.
Scope (Domain)	Geographic data covering the whole world
Use cases (Motivation, Relevance)	Linked Geo Data can serve as a crystallisation point for future spatial web data integration, since it provides unique URIs and exposes its content as Linked Data. Mappings to DBpedia were established already and other knowledge bases are likely to be interlinked with LGD in the future.
Statistics	LinkedGeoData consists of more than 3 billion nodes and 300 million ways and the resulting RDF data comprises approximately 20 billion triples. Unfortunately, last version seems from 2014.
Questions	

Conclusions

Work package 3 of the Ready4SmartCities project aims at identifying the knowledge and data that can support interoperability in energy measurement and validation by identifying and assessing relevant ontologies, vocabularies and standards, as well as relevant datasets and alignments.

With the current report this goal has been fully reached. The work has been carried out in cooperation with work package 3 leading to shared efforts in developing the underlying methodology and the provision of a general tool support, namely the ontology and dataset catalogue, the pitfall scanner as well as the alignment tool. Identified resources have been shared between both work packages and collected in the online catalogues. At the end of the project, a total number of 70 ontologies and 18 datasets from relevant domains have been published by following LOD principles, and alignments among them have been explored.

The developed online catalogue of ontologies and datasets is equipped with filtering features and provides a SPARQL endpoint so that users can query the RDF version of the catalogue. In addition, in order to provide a more detailed assessment (e.g., related to good modeling practices), the OWL ontologies available on the Web are evaluated by OOPS! (Ontology Pitfall Scanner!), an on-line application used to identify pitfalls in ontologies.

The Alignment server has filled the need for interoperability by providing an extensive network of 317 curated alignments between 42 ontologies covering the core ontologies of the domain. Such alignments may be used for transforming queries across datasets or importing some data under another ontology.

Links from the dataset catalogue to the ontology catalogue have been created and included in the web portal. In addition the ontology, dataset and alignment catalogues have been connected in the following way:

- Connection from the ontology pages to the alignment server, and vice-versa
- Connection from the dataset pages to the ontologies within the catalogue and outside.

Concerning alignments, the Alignment server will be maintained online and we plan to improve its content. This involves adding new ontologies to be aligned, exploiting other matchers if necessary and, above all, having alignment curation by specialists of the domain. This last activity will contribute to better evaluation of the alignment results. In turn, this may require technical improvements in the alignment server to support curation.

In addition to these activities, greater effort has been directed at stakeholders and users of the project results, to further assist them in making use of the collected knowledge. In particular, European municipalities were engaged in order to better understand their needs with regards to interoperability in Smart Cities, and based on that, to understand how to best approach these stakeholders in order to enable them to effectively make use of the produced tools and guidance towards interoperable data.

The outcome of these engagement efforts was the development of an ontology that can be used by European municipalities to generate and publish Linked Open Data. The ontology was developed in cooperation with European municipalities and reflects their requirements and systems used. It is generic yet freely extendable to accommodate new requirements in a changing environment. Another outcome was the production of an energy consumption based use case that provides a basis for discussion with stakeholders who are at the stage of looking to implement a first example towards interoperable energy data. The use case is documented more extensively in WP4 under the guidelines for energy data exploitation.

The work carried out in work package 3 and in cooperation with work package 2 provides a solid basis for any stakeholder wishing to take advantage of linked data by providing the necessary tools in the form of a comprehensive catalogue with available ontologies and datasets. This technical basis combined with the



comprehensive guidelines produced as part of work package 4 enables stakeholders to produce Linked Data and raises awareness of the opportunities it offers Smart Cities towards becoming interoperable.

References

- [Beetz et al. 2005] Beetz, J., Leeuwen, J.P. van & Vries, B. de (2005). *An Ontology Web Language Notation of the Industry Foundation Classes*. In R.J. Scherer, P. Katranuschkov & S.-E Schapke (Eds.), *Proceedings of the 22nd CIB W78 Conference on Information Technology in Construction*, (pp. 193-198). Dresden: Technical University of Dresden.
- [Beetz et al. 2009] Beetz, J., Leeuwen, J.P. van & Vries, B. de (2009). *IfcOWL: A case of transforming EXPRESS schemas into ontologies*. *Artificial Intelligence for Engineering Design, Analysis and Manufacturing*, 23 (Special Issue 01), 89-101
- [Bizer, Heath, & Berners-Lee 2009] Bizer, C., T. Heath, & T. Berners-Lee (2009). *Linked Data – the story so far*. *International Journal on Semantic Web and Information Systems* 5, 1–22.
- [Brickley, 2004] Brickley, D. (2004). *RDF vocabulary description language 1.0: RDF schema*. <http://www.w3.org/tr/rdf-schema/>.
- [Euzenat and Shvaiko, 2013] J. Euzenat, P. Shvaiko, *Ontology matching*, 2nd ed., Springer, Heidelberg (DE), 2013
- [García-Castro et al, 2014] García-Castro, R., Poveda-Villalón, M., Radulovic, F., Gómez-Pérez, A., Euzenat, J., Priego-Roche L.M., Vogt, G., Robinson, S., Birov, S., Fies, B. (2013). *Deliverable 3.1: Strategy for Energy Management System Interoperability*. READY4SmartCities project.
- [Liebich et al. 2013] Liebich T., Stuhlmacher K., Weise M., Guruz R., Katranuschkov P., Scherer R. J. (2013). *Information Delivery Manual Work within HESMOS -A descriptive approach to defining Information Delivery Manuals-*. Deliverable D+ of the HESMOS project.
- [Poveda-Villalón et al., 2012] M. Poveda-Villalón, M.C. Suárez-Figueroa, A. Gómez-Pérez. *Validating ontologies with OOPS!*. 18th International Conference on Knowledge Engineering and Knowledge Management. Galway, Ireland. 8-12 October 2012.