



**HAL**  
open science

# Loosely Time-Triggered Architectures: Improvements and Comparisons

Guillaume Baudart, Timothy Bourke, Albert Benveniste

► **To cite this version:**

Guillaume Baudart, Timothy Bourke, Albert Benveniste. Loosely Time-Triggered Architectures: Improvements and Comparisons. Proceedings of the 12th International Conference on Embedded Software (EMSOFT '15), Oct 2015, Amsterdam, Netherlands. 10.1109/EMSOFT.2015.7318263 . hal-01243005

**HAL Id: hal-01243005**

**<https://inria.hal.science/hal-01243005v1>**

Submitted on 14 Dec 2015

**HAL** is a multi-disciplinary open access archive for the deposit and dissemination of scientific research documents, whether they are published or not. The documents may come from teaching and research institutions in France or abroad, or from public or private research centers.

L'archive ouverte pluridisciplinaire **HAL**, est destinée au dépôt et à la diffusion de documents scientifiques de niveau recherche, publiés ou non, émanant des établissements d'enseignement et de recherche français ou étrangers, des laboratoires publics ou privés.

# Loosely Time-Triggered Architectures: Improvements and Comparisons

Guillaume Baudart  
DI École normale supérieure  
Inria, Paris - Rocquencourt

Albert Benveniste  
Inria, Rennes

Timothy Bourke  
Inria, Paris - Rocquencourt  
DI École normale supérieure

## ABSTRACT

Loosely Time-Triggered Architectures (LTTAs) are a proposal for constructing distributed embedded control systems. They build on the quasi-periodic architecture, where computing units execute ‘almost periodically’, by adding a thin layer of middleware that facilitates the implementation of synchronous applications.

In this paper, we show how the deployment of a synchronous application on a quasi-periodic architecture can be modeled using a synchronous formalism. Then we detail two protocols, *Back-Pressure* LTTA, reminiscent of elastic circuits, and *Time-Based* LTTA, based on waiting. Compared to previous work, we present controller models that can be compiled for execution and a simplified version of the Time-Based protocol. We also compare the LTTA approach with architectures based on clock synchronization.

## 1. INTRODUCTION

This paper is about implementing programs expressed as stream equations, like those written in Lustre, Signal, or the discrete subset of Simulink, over networks of embedded controllers. Since each controller is activated on its own local clock, some *middleware* is needed to ensure the correct execution of the original program. One possibility is to rely on a clock synchronization protocol as in the Time-Triggered Architecture (TTA) [21]. Another is to use less constraining protocols as in the Loosely Time-Triggered Architecture (LTTA) [2, 3, 5, 11, 26].

The embedded applications that we consider involve both continuous control and discrete logic. Since the continuous layers are naturally robust to sampling artifacts, controllers can simply communicate through shared memory without additional synchronization. But the discrete logic for mode changes and similar functionalities is very sensitive to such artifacts, and requires more careful coordination. The LTTA protocols are intended for this class of embedded systems. They extend communication by sampling with minimal mechanisms that preserve the semantics of the discrete layer. They

are simple to implement and involve little additional network communication. They thus remain an interesting alternative to solutions based on clock synchronization despite their undeniable advantages.

There are two LTTA protocols: *Back-Pressure* and *Time-Based*. The Back-Pressure protocol is based on acknowledging the receipt of messages. While very efficient, it introduces control dependencies. The Time-Based protocol is based on a waiting mechanism. It is less efficient but allows controllers to operate more independently.

### *Contributions.*

In this paper we consolidate previous work on LTTAs [2, 11, 26] in a synchronous formalism that uniformly encompasses both protocols and applications. Indeed, protocol controllers are also synchronous programs: they can be compiled together with application code. Any synchronous language [4] could be used to express the general LTTA framework, its instantiations with specific protocols, and applications themselves. But we choose Zélus [6]<sup>1</sup> because it also supports a continuous model of time, which allows the direct expression of timing constraints from the underlying network architecture, giving a single, coherent, and precise model. These timing constraints arise from the fact that controllers are activated *quasi-periodically*, that is periodically but with jitter, and because transmission delays are bounded. Not only do we clarify the models and reasoning presented in previous papers, but we give a simpler version of the Time-Based protocol and prove it correct. Finally, modern clock synchronization protocols are now cost-effective and precise [13, 21, 22, 25], raising the question: *Is there really any need for the LTTA protocols?* We thus compare, for the first time, the LTTA protocols with approaches based on clock synchronization.

### *Overview.*

In section 2, we formalize quasi-periodic architectures, model their timing constraints in Zélus, and recall the fundamentals of synchronous applications. Then, in section 3, we present a general framework for modeling controller networks and LTTA protocols. This framework is instantiated with the two LTTA protocols in section 4. Finally, in section 5, we compare the protocols to an approach based on clock synchronization.

<sup>1</sup>Appendix A presents an overview of Zélus. Appendix F presents the source code of a complete example.

## 2. WHAT IS AN LTTA?

An LTTA is the combination of a quasi-periodic architecture with a protocol for deploying synchronous applications. We now present the key definitions of quasi-periodic architectures (section 2.1) and synchronous applications (section 2.3).

### 2.1 Quasi-Periodic Architectures

Introduced in [10], the *quasi-synchronous approach* is a set of techniques for building distributed control systems. It is a formalization of practices that Paul Caspi observed while consulting in the 1990s at Airbus, where engineers were deploying synchronous Lustre/SCADE [16, 18] designs onto networks of non-synchronized nodes communicating via shared memories with bounded transmission delays.

The quasi-synchronous approach applies to systems of periodically executed (sample-driven) nodes. In contrast to the Time-Triggered Architecture [21], it does not rely on clock synchronization. Such systems arise naturally as soon as two or more microcontrollers running periodic tasks are interconnected. They are common in aerospace, nuclear power, and rail transportation.

DEFINITION 1 (QUASI-PERIODIC ARCHITECTURE).

A quasi-periodic architecture is a finite set of nodes  $\mathcal{N}$ , where every node  $n \in \mathcal{N}$  executes periodically but the actual time between any two activations  $T \in \mathbb{R}$  may vary between known bounds during an execution:

$$0 < T_{\min} \leq T \leq T_{\max}. \quad (1)$$

Values are transmitted between processes with a delay  $\tau \in \mathbb{R}$ , bounded by  $\tau_{\min}$  and  $\tau_{\max}$ ,

$$0 < \tau_{\min} \leq \tau \leq \tau_{\max}. \quad (2)$$

Each is buffered at receivers until a newer value is received.

Since we consider all possible behaviors, a quasi-periodic system can also be characterized by its nominal period  $T_n$  and maximum jitter  $\varepsilon$ , where  $T_{\min} = T_n - \varepsilon$  and  $T_{\max} = T_n + \varepsilon$  and similarly for the transmission delay. The margins encompass all sources of divergence between nominal and actual values, including relative clock jitter, interrupt latencies, and scheduling delays. We assume that individual processes are synchronous: reactions triggered by a local clock execute in zero time (atomically with respect to the local environment).

In the original quasi-synchronous approach, transmission delays are only constrained to be ‘significantly shorter than the periods of read and write clocks’ [10, § 3.2.1]. We introduce explicit bounds in equation (2) to make the definition more precise and applicable to a wider class of systems. They can be treated naturally in our modeling approach.

Nodes communicate through shared memories which are updated atomically. A given variable is updated by a single node, but may be read by several nodes. The values written to a variable are sent from the producer to all consumers, where they are stored in a specific (one-place) buffer. The buffer is only sampled when the process at a node is activated by the local clock. This model is sometimes termed *Communication by Sampling* (CbS) [3].

Finally, we assume that the network guarantees message delivery and preserves message order. That is, for the latter, if message  $m_1$  is sent before  $m_2$ , then  $m_2$  is never received before  $m_1$ . This is necessarily the case when  $\tau_{\max} < T_{\min} + \tau_{\min}$ , otherwise this assumption only burdens implementations

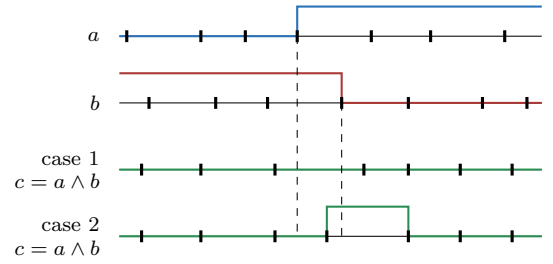

Figure 1: The effect of sampling on signal combinations.

with the technicality of numbering messages and dropping those that arrive out of sequence.

#### Value duplication and loss.

The lack of synchronization in the quasi-periodic architecture means that successive variable values may be duplicated or lost. For instance if a consumer of a variable is activated twice between the arrivals of two successive messages from the producer, it will *oversample* the buffered value. On the other hand, if two messages of the producer are received between two activations of the consumer, the second value *overwrites* the first, which is then never read. These effects occur for any  $\varepsilon > 0$ , regardless of how small.

The timing bounds of definition 1 mean, however, that the maximum numbers of consecutive oversamplings and overwritings are functions of the bounds on node periods and transmission delays (see appendix B for proofs).

PROPERTY 1. Given a pair of nodes executing and communicating according to definition 1, the maximum number of consecutive oversamplings and overwritings is

$$n_{os} = n_{ow} = \left\lceil \frac{T_{\max} + \tau_{\max} - \tau_{\min}}{T_{\min}} \right\rceil - 1. \quad (3)$$

This property implies that data loss can be prevented by activating a consumer much more frequently than the corresponding producer (at the cost of higher oversampling). Quasi-periodic architectures involving producer-consumer pairs are studied in [5].

Quasi-periodic architectures are a natural fit for continuous control applications, where the error due to sampling artifacts can be computed and compensated. In this paper, however, we treat discrete systems, like state machines, which are generally intolerant to data duplication and loss.

#### Signal combinations.

There is another obstacle to implementing discrete applications on a quasi-periodic architecture: naively combining variables can give results that diverge from the reference semantics. Consider, for example, figure 1 [10, §4.2.2][2, 11]. A node  $C$  reads two boolean inputs  $a$  and  $b$ , produced by nodes  $A$  and  $B$ , respectively, and computes the conjunction,  $c = a \wedge b$ . Here,  $a$  is *false* for four activations of  $A$  before becoming *true* and  $b$  is *true* for four activations of  $B$  before becoming *false*. In a synchronous semantics, with simultaneous activations of  $A$ ,  $B$  and  $C$ , node  $C$  should return *false* at each activation. But, as figure 1 shows, the value computed depends on when each of the nodes is activated. This phenomena cannot be avoided by activating nodes less or more frequently.

## 2.2 Modeling Quasi-Periodic Architectures

One of the central ideas of the original quasi-synchronous approach is to replace detailed timing behavior with a discrete abstraction [10, §3.2]. Basically, a system is modeled, in Lustre, for example, as a composition of discrete programs activated by a ‘scheduler’ program that limits interleaving [19]. Now, rather than arising as a consequence of the timing constraints of definition 1, properties like property 1 are enforced directly by the scheduler. This approach allows the application of discrete languages, simulators, and model-checkers, but it does not apply to the present setting where ‘short undetermined transition delays’ [10, §3.2.1] are replaced by equation (2). In fact, Caspi knew that ‘if longer transmission delays are needed, modeling should be more complex’ [10, §3.2.1, footnote 2]. The earliest paper on LTTAs [5] models messages in transmission, but still in a discrete model. Later papers introduce a class of protocols that rely on the timing behavior of the underlying architecture. Their models mix architectural timing constraints with protocol details using automata [11] or ad hoc extensions of timed Petri nets [2]. In contrast, we use Zélus [6], a synchronous language extended with continuous time, where we can clearly separate real-time constraints from discrete control logic, but still combine both in an executable language.

Let us first consider a quasi-periodic clock that triggers the activation of an LTTA node according to equation (1). Such a clock can be simulated in Zélus using a timer, a simple Ordinary Differential Equation (ODE)  $\dot{t} = 1$ , initialized to an arbitrary value between  $-T_{\min}$  and  $-T_{\max}$ , and similarly reinitialized whenever  $t$  reaches 0. As Zélus is oriented towards numerical simulation, we must make two compromises for our program to be executable. First, rather than an arbitrary value, we choose at random:<sup>2</sup>

```
let node arbitrary (l, u) = l +. Random.float (u -. l)
```

This declares a function named `arbitrary` with two inputs and defined by a single expression; the keyword `node` indicates a discrete stream function. Second, the reinitialization condition is encoded as a (*rising*) *zero-crossing expression* which a numeric solver monitors to detect and locate significant instants. These choices made, the model for node clocks is:

```
let hybrid metro (t_min, t_max) = c where
  rec der t = 1.0 init -. arbitrary (t_min, t_max)
  reset up(last t) → -. arbitrary (t_min, t_max)
  and present up(last t) → do emit c = () done
```

```
val metro : float * float  $\xrightarrow{c}$  unit signal
```

The keyword `hybrid` indicates that node inputs and outputs are continuous. The variable `t` is initialized as described above and increases with slope 1.0. The expression `up(last t)` registers a zero-crossing expression on (the left-limit of) `t`. At zero-crossing instants, a signal `c` is emitted and `t` is reset.

Similarly, the constraint on transmission delays from equation (2) is modeled by delaying the discrete signal corresponding to the sender’s clock. A simple Zélus model is:

```
let hybrid delay(c, tau_min, tau_max) = dc where
  rec der t = 1.0 init 0.0
  reset c() → -. arbitrary (tau_min, tau_max)
  and present up(t) → do emit dc = () done
```

```
val delay : unit signal * float * float  $\xrightarrow{c}$  unit signal
```

<sup>2</sup>+, −., \*, /. denote floating-point operations

The function `delay` takes a clock `c` as input. When `c` ticks, the timer is reinitialized to an arbitrary value between  $-\tau_{\min}$  and  $-\tau_{\max}$  corresponding to the transmission delay. Then, when the delay has elapsed, that is, when a zero-crossing is detected, a signal `dc` for the delayed clock is emitted. The presented model is simplified for readability. In particular, it does not allow for simultaneous ongoing transmissions, that is, it mandates  $\tau_{\max} < T_{\min}$ . The full version, given in appendix D, queues ongoing transmissions which complicates the model without providing any new insights.

## 2.3 Synchronous Applications

This paper addresses the deployment of *synchronous applications* onto a quasi-periodic architecture. By synchronous application, we mean a synchronous program that has been compiled into a composition of communicating Mealy machines. The question of generating such a form from a high-level language like Lustre/SCADE, Signal, or Esterel [4] does not concern us here.

In the synchronous model, machines are executed in lock-step. But as our intent is to distribute each machine onto its own network node, we must show that a desynchronized execution yields the same overall input/output relation as the reference semantics. The aim is to precisely describe the activation model and the related requirements on communications, and thereby the form of, and the constraints on program distribution. The desynchronized executions we consider are still idealized—reproducing them on systems satisfying definition 1 is the subject of section 4.

A Mealy machine  $m$  is a tuple  $\langle s_{\text{init}}, I, O, F \rangle$ , where  $s_{\text{init}}$  is an initial state,  $I$  is a set of input variables,  $O$  is a set of output variables, and  $F$  is a transition function mapping a state and input values to the next state and output values:

$$F : \mathcal{S} \times \mathcal{V}^I \rightarrow \mathcal{S} \times \mathcal{V}^O$$

where  $\mathcal{V}$  is the domain of variable values, and  $\mathcal{S}$  is the domain of state values. A Mealy machine  $m = \langle s_{\text{init}}, I, O, F \rangle$  defines a stream function<sup>3</sup>

$$\llbracket m \rrbracket : (\mathcal{V}^I)^\infty \rightarrow (\mathcal{V}^O)^\infty$$

generated by repeated firings of the transition function from the initial state:

$$\begin{aligned} s(0) &= s_{\text{init}} \\ s(n+1), o(n) &= F(s(n), i(n)). \end{aligned}$$

The fact that the outputs of Mealy machines may depend instantaneously on their inputs makes both composition [24] and distribution over a network [12] problematic. An alternative is to only consider a ‘Moore-style’ composition of Mealy machines: outputs may be instantaneous but communications between machines must be delayed. A machine must wait one step before consuming a value sent by another machine. This choice precludes the separation of subprograms that communicate instantaneously, but it increases node independence and permits simpler protocols. For a variable  $x$ , let  $\bullet x$  denote its delayed counterpart ( $\bullet x(n) = x(n-1)$ ). Similarly, let  $\bullet X = \{\bullet x \mid x \in X\}$ . Now, a set of machines  $m_1, m_2, \dots, m_p$  can be composed to form a *system*  $N = m_1 \parallel m_2 \parallel \dots \parallel m_p$ . The corresponding

<sup>3</sup> $\mathcal{X}^\infty = \mathcal{X}^* \cup \mathcal{X}^\omega$  denotes the set of possibly finite streams over elements of the set  $\mathcal{X}$ .

Mealy machine  $N = \langle s_{\text{init}}, I, O, F_N \rangle$  is defined by

$$\begin{aligned} I &= I_1 \cup \dots \cup I_p \setminus \bullet O, \\ O &= O_1 \cup \dots \cup O_p, \\ s_{\text{init}} &= (s_{\text{init}_1}, \dots, s_{\text{init}_p}, \text{nil}, \dots, \text{nil}) \\ F_N((s_1, \dots, s_p, \bullet O), I) &= ((s'_1, \dots, s'_p, O), O) \end{aligned}$$

where  $(s'_i, o_i) = F_i(s_i, i_i)$ . The actual inputs of the global Mealy machine are the inputs of all machines  $m_i$  that are not delayed versions of variables produced by other machines. At each step a delayed version of the output of machines  $m_i$ , initialized with *nil*, is stored into the state of the global Mealy machine. The abuse of notation in  $F_N$  describes the shuffling of input, output, and delayed variables.

The composition is well defined if the following conditions hold: For all  $m_i \neq m_j$ ,

$$I_i \cap O_j = \emptyset, \quad (4)$$

$$O_i \cap O_j = \emptyset, \text{ and} \quad (5)$$

$$I_i \setminus \bullet O \cap I_j \setminus \bullet O = \emptyset, \quad (6)$$

Equation (4) states that no machine ever directly depends on the output of another. Equation (5) imposes that a variable is only defined by one machine. Finally, equation (6) states that an input from the environment is only consumed by a single machine. Additionally, since the delayed outputs are initially undefined, the composition is only well defined when the  $F_i$  do not depend on them at the initial instant.

In the synchronous model, all processes run in lock-step, that is, executing one step of  $N$  executes one step of each  $m_i$  in no particular order. Thus, at each step, all inputs are consumed simultaneously to immediately produce all outputs. The *Kahn semantics* [20] proposes an alternative model where each machine is considered a function from a tuple of input streams to a tuple of output streams (the variables effectively become unbounded queues). Synchronization between distinct components of tuples and between the activations of elements in a composition are no longer required. The semantics of a program is defined by the sequence of values at each variable:

$$\llbracket m \rrbracket^K : (\mathcal{V}^\infty)^I \rightarrow (\mathcal{V}^\infty)^O.$$

**THEOREM 1.** *For Mealy machines, composed as described above, the synchronous semantics and the Kahn semantics are equivalent*

$$\llbracket m \rrbracket \approx \llbracket m \rrbracket^K.$$

The proof of this theorem is given in appendix C.

The overall idea is to take a synchronous application that has been arranged into a Moore-composition of Mealy machines  $N = m_1 \parallel m_2 \parallel \dots \parallel m_p$ , so that each machine  $m_i$  can be placed on a distinct network node. If the transmission and consumption of values respects the Kahn semantics then the network correctly implements the application. Since we do not permit instantaneous dependencies between variables computed at different nodes, a variable  $x$  computed at one node may only be accessed at another node through a *unit delay*, that is, a delay of one logical step. In this way we need not ‘microschedule’ node activations.

### 3. GENERAL FRAMEWORK

We now consider the implementation of a synchronous application  $S$  of  $p$  Mealy machines communicating through unit delays onto a quasi-periodic architecture with  $p$  nodes.

This task is trivial if the underlying nodes and network are *completely synchronous*, that is,  $T_{\min} = T_{\max} \geq \tau_{\max}$  and with all elements initialized simultaneously. One simply compiles each machine and assigns it to a node. At each tick, all the machines compute simultaneously and send values to be buffered at consumers for use at the next tick. The synchronous semantics of an application is preserved directly.

In our setting, however, node activations are not synchronized and we must confront the artifacts described in section 2.1: duplication, loss of data, and potentially unintended signal combinations. We do this by introducing a thin layer of middleware between application and architecture. An LTTA is exactly this combination of a quasi-periodic architecture with a protocol that preserves the semantics of synchronous applications. We denote the implementation of an application  $S$  on a quasi-periodic architecture as  $\text{LTTA}(S)$ . In this section we present the general framework of this implementation based on a discrete synchronous model of the architecture. The details of the two LTTA protocols are presented in section 4.

#### 3.1 From Continuous to Discrete Time

We describe the protocols by adapting a classical approach to architecture modeling using synchronous languages [17]. In doing so, we exploit the ability of the Zélus language [6] to express delays without a priori discretization.

The quasi-periodic architecture is modeled by a set of clocks (see section 2.2). Signals  $c_1, c_2, \dots$  denote the quasi-periodic clocks of the nodes, and  $dc_1, dc_2, \dots$  their delayed versions that model transmission delays. The union of all these signals is a global signal  $g$  which is emitted on each event. In Zélus, we write:

```
present c1() | dc1() | c2() | dc2() | ... → do emit g = () done
```

The signal  $g$  gives a base notion of logical instant or step. It allows us to model the rest of the architecture in a discrete synchronous framework.

Variables are not necessarily always defined. This is expressed in Zélus by valued *signals*. If necessary, a signal value can be maintained in a *memory* which stores the last received value until the next update.

```
let node mem(i, default) = m where
  rec init m = default
  and present i(v) → do m = v done
```



```
val mem : 'a signal * 'a → 'a
```

The keyword **init** initializes a memory  $m$  with a default value **default**. Each time the input signal  $i$  is emitted, the variable  $m$  is updated with the new received value  $v$ .

#### 3.2 Modeling Nodes

An LTTA node is formed by composing a Mealy machine with a controller that determines when to execute the machine and when to send outputs to other nodes. The basic idea comes from the *shell wrappers* of Latency Insensitive Design (LID) [8,9]. The schema is shown in figure 2. A node is activated at each tick of its quasi-periodic clock  $c$ :

```
present c() → do o = ltta_node(i, default) done
```

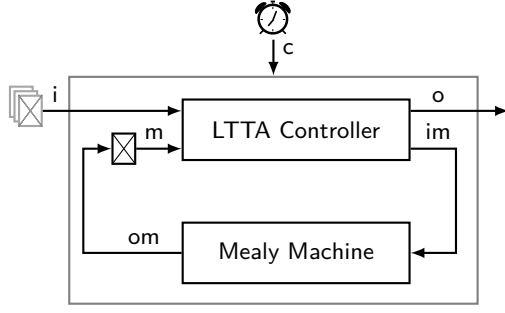

Figure 2: Schema of an LTTA node: a Mealy machine is encapsulated with a protocol controller. The crossed box is implemented by the `mem` function defined in section 3.1.

An LTTA node is modeled in Zélus as:

```
let node ltta_node(i, default) = o where
  rec m = mem(om, default)
  and (o, im) = ltta_controller(i, m)
  and present im(v) → do emit om = machine(v) done
```

```
val ltta_node : 'a list * 'b  $\xrightarrow{D}$  'b signal
```

The controller node is instantiated with one of the controllers described in the following section. At instants determined by the protocol, the controller samples a list of inputs from incoming LTTA links `i` and passes them on `im` to trigger the machine, which produces output `om`. The value of `om` is stored in a memory `m`, and sent on outgoing LTTA links `o` when the protocol allows.

The function of the controller is to preserve the semantics of the global synchronous application by choosing 1) when to execute the machine (emission of signal `im`), and, 2) when to send the resulting outputs (emission of signal `o`). Neither of the two presented protocols computes and sends an output instantaneously. They both thus reintroduce the unit delays required for correct distribution.

### 3.3 Modeling Links

Delayed communications are modeled by an unbounded FIFO queue that is triggered by the input signal and the delayed sender clock that models transmission delays `dc` (see section 2.2). Messages in transmission are stored in the queue and emitted when the transmission delay elapses, that is, if clock `dc` ticks when the queue is not empty.

```
let node channel(dc, i) = o where
  rec init q = empty()
  and trans = not (is_empty (last q))
  and present
    | i(v) & dc() on trans →
      do emit o = front(last q)
      and q = enqueue(dequeue(last q), v) done
    | i(v) → do q = enqueue(last q, v) done
    | dc() on trans →
      do emit o = front(last q)
      and q = dequeue(last q) done
```

```
val channel : unit signal * 'a signal  $\xrightarrow{D}$  'a signal
```

Each new message `v` received on signal `i` is added at the end of the queue: `q = enqueue(last q, v)`. The keyword `last` refers to the last defined value of a variable. Then, when a transmission delay has elapsed, that is, each time clock `dc`

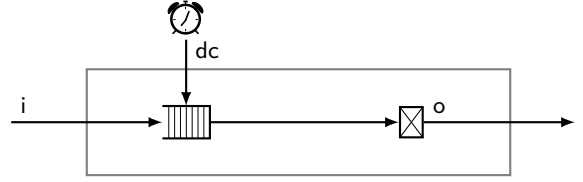

Figure 3: Schema of communication links modeling delayed transmission between nodes. The striped box represents a FIFO queue.

ticks when the queue is not empty (when `trans` is set to `true`), the first pending message is emitted on signal `o` and removed from the queue: `emit o = front(last q)` and `q = dequeue(last q)`.

Finally, a link between two distinct nodes, shown in figure 3, stores the last received value in a memory. Since nodes are not synchronized, the output of a link must be defined at each logical step. All link nodes are thus activated at every emission of `g`.

```
let node link(dc, i, default) = o where
  rec s = channel(dc, i)
  and o = mem(s, default)
```

```
val link : unit signal * 'a signal * 'a  $\xrightarrow{D}$  'a
```

When a message is sent on signal `i`, it goes through the channel and, after the transmission delay, is stored in a memory. New messages overwrite previous memory values. The memory contents are output by the link.

#### Fresh values.

The LTTA controllers must detect when a fresh write is received in an attached shared memory even when the same value is resent. An *alternating bit* protocol suffices for this task since the controllers ensure that no values are missed:

```
type 'a msg = {data : 'a; alt : bool}
let node alternate i = o where
  rec present i(v) → local flag in
    do flag = true → not (pre flag)
    and emit o = {data = v; alt = flag} done
```

```
val alternate : 'a signal  $\xrightarrow{D}$  'a msg signal
```

The value of the boolean variable `flag` is associated to each new value received on signal `i`. This value alternates between `true` and `false` at each emission of signal `i`. This simple protocol logic is readily incorporated into the link model.

```
let node ltta_link(dc, i, default) = o where
  rec s = channel(dc, i)
  and o = mem(alternate(s), default)
```

```
val ltta_link : unit signal * 'a signal * 'a msg  $\xrightarrow{D}$  'a msg
```

An alternating bit is associated to each new value stored in the memory. Within a controller, the freshness of an incoming value can now be detected and signaled:

```
let node fresh(i, r) = o where
  rec init m = false
  and present r(_) → do m = i.alt done
  and o = (i.alt <> last m)
```

```
val fresh : 'a msg * 'b signal  $\xrightarrow{D}$  bool
```

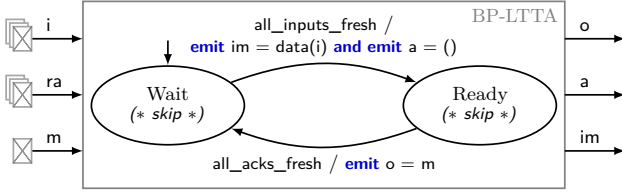

Figure 4: The Back-Pressure LTTA controller. The additional inputs  $ra$  are acknowledgments from consumers. The additional output  $a$  is for acknowledging producers.

Variable  $m$  stores the alternating bit associated to the last read value and is updated at each new read signaled by an emission on  $r$ . A fresh value is detected when the current value of the alternating bit differs from the one stored in  $m$ , that is,  $(i.alt \ll> last\ m)$ .

## 4. THE LTTA PROTOCOLS

We now present two LTTA protocols: one based on back-pressure (section 4.1) and another based on time (section 4.2).

### 4.1 Back-Pressure LTTA

The Back-Pressure protocol [26] is inspired by *elastic circuits* [14, 15] where a consumer node must acknowledge each value read by writing to a *back pressure* [7] link connected to the producer. This mechanism allows executing a synchronous application on an asynchronous architecture while preserving the Kahn semantics. In an elastic circuit nodes are triggered as soon as all their inputs are available. This does not work for LTTA nodes since they are triggered by local clocks, so a *skipping* mechanism was introduced in [26] and included in later Petri net formalizations [1, 2].

For each link from a node  $A$  to a node  $B$ , we introduce a back-pressure link from  $B$  to  $A$ . This link is called a (acknowledge) at  $B$  and  $ra$  (receive acknowledge) at  $A$ . The controller, shown in figure 4, is readily programmed in Zélus:

```

let node bp_controller (i, ra, m) = (o, a, im) where
rec automaton
  | Wait →
    do (* skip *)
    unless all_inputs_fresh then
      do emit im = data(i) and emit a = () in Ready
  | Ready →
    do (* skip *)
    unless all_acks_fresh then
      do emit o = m in Wait

and all_inputs_fresh = forall_fresh(i, im)
and all_acks_fresh = forall_fresh(ra, o)

val bp_controller :
  'a msg list * 'b msg list * 'c  $\xrightarrow{D}$ 
  'c signal * unit signal * 'a list signal

```

The controller automaton has two states. It starts in Wait and skips at each tick until fresh values have been received on all inputs. It then triggers the machine (`data()` discards the alternating bit), sends an acknowledgement to the producer and transitions immediately to Ready. The controller skips in Ready until acknowledgements have been received from all consumers indicating that they have consumed the most recently sent outputs. It then sends the outputs from the last activation of the machine and returns to Wait.

In parallel, the freshness of the inputs since the last execution of the machine is tested by a conjunction of fresh nodes. Similarly the controller also tests whether fresh acknowledgements have been received from all consumers since the last emission of the output signal  $o$ .

**THEOREM 2.** *The composition of a Back-Pressure controller and a Mealy machine to form a Back-Pressure LTTA node is well defined.*

**PROOF.** The dependency graph of the controller is:

$$im \leftarrow i \quad a \leftarrow i \quad o \leftarrow ra \quad o \leftarrow m.$$

The definition of the local memory  $m$  adds the dependency  $m \leftarrow om$ . Since the dependency graph of the machine is, at worst,  $om \leftarrow im$ , the composition of the two machines is free of cycles and therefore well defined.  $\square$

### Preservation of Semantics.

This result was first proved in [26] for networks of nodes communicating through buffers of arbitrary size. Another proof is given in [2] based on the relation with elastic circuits. We sketch this proof here; details are to be found in [1].

**THEOREM 3** ([2, 26]). *Implementing a synchronous application  $S$  over a quasi-periodic architecture with Back-Pressure controllers preserves the Kahn semantics of the application:*

$$\llbracket LTTA_{BP}(S) \rrbracket^K = \llbracket S \rrbracket^K.$$

**PROOF.** The idea is to show that both nodes and links can be encoded as simple event graphs, that is, one-safe Petri nets, that behave like elastic circuits. Event graphs associated to links contain two places, a direct place that models data transfer and a back-pressure place that models consumer acknowledgment. The controller is also modeled as an event-graph with two places that alternate between *send* and *execute* transitions. This net is then extended with a skipping mechanism that allows the controller to transition on local clock ticks if not all inputs are available.

Now, assuming that no transition can be enabled forever without firing, one can show that the LTTA implementation of the application behaves like the elastic circuit version of the same application which is known to implement the Kahn semantics of a synchronous application.  $\square$

### Performance Bounds.

Using the assumptions on local clock periods and transmission delays of the underlying quasi-periodic architecture, that is, equations (1) and (2), we can analyze the performance of Back-Pressure LTTA nodes.

**THEOREM 4** ([2, 26]). *The worst case throughput of a Back-Pressure LTTA node is*

$$\lambda_{BP} = 1/2(T_{max} + \tau_{max}).$$

A formal proof based on Petri nets is presented in [1]. Here we give just an intuition for the case of two nodes  $A$  and  $B$  with  $B$  receiving messages from  $A$ . In the worst case, when  $A$  sends a message at time  $t$  it arrives in  $B$ 's shared memory at  $t + \tau_{max}$  just after a tick of  $B$ 's clock. Therefore  $B$  does

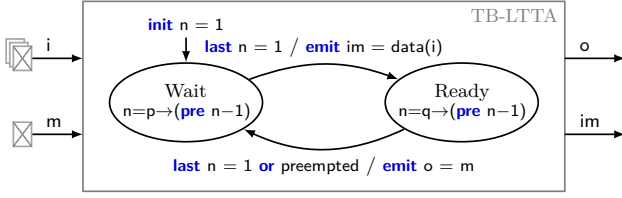

Figure 5: The Time-Based LTTA controller. A counter  $n$  is decremented in each state initialized with value  $p$  in state WAIT and  $q$  in state READY.

not detect the message until  $t + T_{\max} + \tau_{\max}$ .<sup>4</sup> Symmetrically, the acknowledgment from  $B$  to  $A$  is received  $T_{\max} + \tau_{\max}$  after the message has been detected. The next round thus starts at  $t + 2(T_{\max} + \tau_{\max})$ .

## 4.2 Time-Based LTTA

The Time-Based LTTA protocol realizes a synchronous execution on a quasi-periodic architecture by alternating *send* and *execute* phases across the nodes. Each node maintains a local countdown whose initial value is tuned according to the timing characteristics of the architecture to ensure that, when the countdown elapses, it is safe to execute the machine or to publish its most recent results.

A first version of the Time-Based LTTA protocol was introduced in [10]. The protocol was formalized as a Mealy machine with five states in [11] and a simplified version was modeled with Petri nets in [1,2]. We propose an even simpler version, formalize it in Zélus, and prove its correctness.

Unlike the Back-Pressure protocol, the Time-Based protocol requires *broadcast communication*, that is, all variable updates must be visible at all nodes (and each node must update at least one variable), but acknowledgment values are not sent when inputs are sampled. The controller for the Time-Based protocol is shown in figure 5, for parameters  $p$  and  $q$ :

```

let node tb_controller (i, ro, m) = (o, im) where
  rec init n = 1
  and automaton
    | Wait →
      do n = p → (pre n - 1)
      unless (last n = 1) then
        do emit im = data(i) in Ready
    | Ready →
      do n = q → (pre n - 1)
      unless ((last n = 1) or preempted) then
        do emit o = m in Wait

  and preempted = exists_fresh(i, im)

val tb_controller :
  'a msg list * 'b msg list * 'c  $\xrightarrow{D}$  'c signal * 'a list signal

```

The controller automaton has two states. Initially, it passes via Wait, emits the signal  $im$  with the value of the input memory  $i$  and thereby *executes* the machine, and enters Ready. In Ready, the equation  $n = q \rightarrow (\text{pre } n - 1)$  initializes a counter  $n$  with the value  $q$  and decrements it at each subsequent tick of the clock  $c$ . At the instant when the Ready counter would become zero, that is, when the previous value **last**  $n$  is one, the controller instead passes directly into the Wait state, resets the counter to  $p$ , and *sends* the previously computed

<sup>4</sup>The worst-case transmission delay is thus  $T_{\max} + \tau_{\max}$ .

outputs from the memory  $m$  (see figure 2) to  $o$ . It may happen, however, that the local clock is much slower than those of other nodes. In this case, a fresh value from any node,  $\text{exists\_fresh}(i, im)$ , preempts the normal countdown and triggers the transition to Wait and the associated writing of outputs ( $\text{exists\_fresh}$  is essentially a disjunction of fresh nodes). The Wait state counts down from  $p$  to give all inputs enough time to arrive before the machine is retriggered.

Basically, nodes slow down by counting to accommodate the unsynchronized activations of other nodes and message transmission delays, but accelerate when they detect a message from other nodes.

**THEOREM 5.** *The composition of a Time-Based controller and a Mealy machine to form a Time-Based LTTA node is always well defined.*

**PROOF.** The proof is similar to that of theorem 2. The worst case dependency graph of a node is:

$$n \leftarrow i \quad o \leftarrow m \quad m \leftarrow om \quad om \leftarrow im \quad im \leftarrow i.$$

It has no cyclic dependencies.  $\square$

### Preservation of Semantics.

The Time-Based protocol only preserves the Kahn semantics of the application if the countdown values  $p$  and  $q$  are correctly chosen.

**THEOREM 6.** *The Kahn semantics of a synchronous application  $S$  implemented on a quasi-periodic architecture using Time-Based controllers is preserved,*

$$\llbracket LTTA_{\text{TB}}(S) \rrbracket^K = \llbracket S \rrbracket^K$$

provided that both

$$p > \frac{2\tau_{\max} + T_{\max}}{T_{\min}} \quad (7)$$

$$q > \frac{\tau_{\max} - \tau_{\min} + (p+1)T_{\max}}{T_{\min}} - p. \quad (8)$$

**PROOF.** The theorem follows from two properties which together imply that the  $k$ th execution of a node samples the  $(k-1)$ th values of its producers. Since nodes communicate through unit delays, the Kahn semantics is preserved.

**PROPERTY 2** ( $S_{k-1}^P \prec E_k^C$ ). *For  $k > 0$ , the  $(k-1)$ th sending of a producer is received at its consumers before their respective  $k$ th executions.*

**PROPERTY 3** ( $E_k^C \prec S_k^P$ ). *For  $k > 0$ , the  $k$ th execution of a consumer occurs before the  $k$ th sending from any of its producers is received.*

The properties are shown by induction on  $k$ ; that is, assuming that they hold up to and including  $k-1$ . The proofs proceed by considering the worst-case scenarios illustrated in Figure 6.

For property 2, if the  $k$ th execution of a consumer  $E_k^C$  occurs at time  $t$  then its  $(k-1)$ th sending  $S_{k-1}^C$  must have occurred at or before  $t - pT_{\min}$  (countdown in Wait with the shortest possible ticks). This sending is detected by any node at worst  $T_{\max} + \tau_{\max}$  later, which causes a producer in the Ready state to send (a producer in the Wait state has already done so), with the value arriving at the consumer at



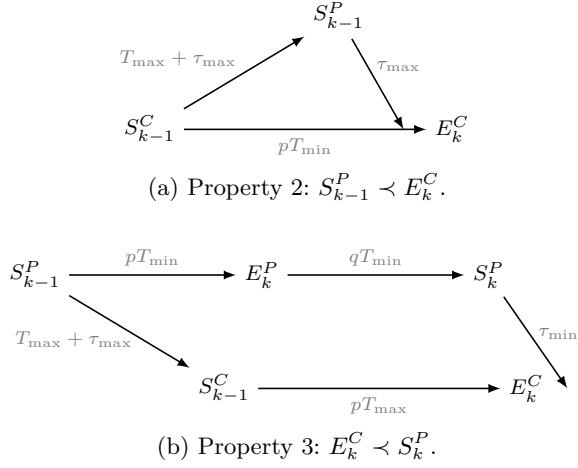

Figure 6: Explanation of the proofs of properties 2 and 3.

most  $\tau_{\max}$  later. Equation (7) guarantees that this happens before the consumer executes.

For property 3, if the  $k$ th execution of a consumer  $E_k^C$  occurs at time  $t$  then its  $(k-1)$ th sending  $S_{k-1}^C$  cannot have occurred before  $t - pT_{\max}$  (countdown in Wait with the longest possible ticks). The first send by a producer in the  $(k-1)$ th round  $S_{k-1}^P$  cannot occur before  $t - pT_{\max} - (T_{\max} + \tau_{\max})$ , since any send preempts the consumer in Ready at worst after a delay of  $T_{\max} + \tau_{\max}$ . Since the smallest delay before the subsequent  $k$ th send of any producer arrives at the consumer is  $pT_{\min} + qT_{\min} + \tau_{\min}$  (countdowns in Wait and Ready with the shortest possible ticks for the first node to publish), equation (8) guarantees that the  $k$ th execution of the consumer occurs beforehand.  $\square$

### Broadcast Communication.

The Time-Based protocol does not wait for acknowledgments from all receivers but rather sends a new value as soon as it detects a publication from another node. Controllers thus operate more independently, but broadcast communication is necessary. Otherwise, consider adding a third node  $N$  to the scenario in figure 6b such that it communicates with node  $P$  but not node  $C$ . Now,  $P$  may be preempted in the Ready state one tick after  $E_k^P$  causing it to send a message that arrives at  $C$  at  $S_{k-1}^P + (p+1)T_{\min} + \tau_{\min}$ . Since node  $C$  would not be preempted by  $N$  but only by  $P$ , in the worst case  $E_k^C$  occurs  $(p+1)T_{\max} + \tau_{\max}$  after  $S_{k-1}^P$ . Property 3 then imposes the impossible condition

$$(p+1)T_{\min} + \tau_{\min} > (p+1)T_{\max} + \tau_{\max}.$$

### Global Synchronization.

In fact, properties 2 and 3 imply strictly more than the preservation of the Kahn semantics of an application.

**COROLLARY 1.** *The Time-Based controller ensures a strict alternation between the execute and send phases throughout the architecture*

**PROOF.** Since the parameters  $p$  and  $q$  are the same for all Time-Based controllers, the following two properties hold:

**PROPERTY 4** ( $S_{k-1}^C < E_k^P$ ). *For  $k \geq 0$ , the  $(k-1)$ th sending of a node is always received at its producers before their respective  $k$ th executions.*

**PROPERTY 5** ( $E_k^P < S_k^C$ ). *For  $k \geq 0$ , the  $k$ th execution of a node always occurs before the  $k$ th send from any of its consumers is received.*

The proofs of these properties resemble those of properties 2 and 3. Since we assume broadcast communication, each node is a potential producer and consumer for all others. Thus the corollary follows directly from properties 2 to 5.  $\square$

Compared to the Back-Pressure protocol, the Time-Based protocol forces a global synchronization of the architecture. In fact, running the Back-Pressure protocol under a broadcast assumption also induces such strict alternations since every node must wait for all others to execute before sending a new value (the protocol can be optimized in this case, see appendix E).

### Performance bounds.

Optimal performance requires minimal values for  $p$  and  $q$ :<sup>5</sup>

$$p^* = \left\lfloor \frac{2\tau_{\max} + T_{\max}}{T_{\min}} \right\rfloor + 1$$

$$q^* = \left\lfloor \frac{\tau_{\max} - \tau_{\min} + (p+1)T_{\max}}{T_{\min}} - p \right\rfloor + 1.$$

**THEOREM 7.** *The worst-case throughput of a Time-Based LTTA node is:*

$$\lambda_{\text{TB}} = 1/(p^* + q^*)T_{\max}.$$

**PROOF.** The slowest possible node spends  $p^*T_{\max}$  in state WAIT and  $q^*T_{\max}$  in state READY.  $\square$

### 4.3 Hybrid LTTA

Back-Pressure controllers are architecture-independent and therefore very flexible. However, they violate the principle of ‘sender independence’ [21, §4.1.1]. If a node crashes and stops sending data, the entire application is stuck forever. In comparison, Time-Based controllers are based on a waiting mechanism tuned with the timing characteristics of the architecture. If a node crashes, other nodes will continue to compute using the last received data. This allows programmers to implement their own fault tolerance policies directly in the application.

The close relationship between the two protocols allows them to be combined within a single system. This technique was introduced in [2], but with the formalization proposed in this paper, the blending of the two LTTA protocols is straightforward and does not require any adaptation. The different components need only be connected together, noting that acknowledgments need not be sent by back-pressure nodes to time-based ones, but that they must be sent by time-based nodes to back-pressure ones.

## 5. CLOCK SYNCHRONIZATION

The LTTA protocols are designed to accommodate the loose timing of node activations in a quasi-periodic architecture. But modern clock synchronization protocols are cost-effective and precise: the Network Time Protocol (NTP) [25]

<sup>5</sup> $\forall x \in \mathbb{R}$ ,  $\lfloor x \rfloor$  denotes the greatest integer  $i$  such that  $i \leq x$ .

and True-Time (TT) [13] provide millisecond accuracies across the Internet, the Precise Time Protocol (PTP) [22] and the Time-Triggered Protocol (TTP) [21, Chapter 8] provide sub-microsecond accuracies at smaller scales. With synchronized clocks, the completely synchronous scheme outlined at the start of section 3 becomes feasible, raising the question: *is there really any need for the LTTA protocols?*

To respond to this question we recall the basics of one of the most efficient clock synchronization schemes in section 5.1, work from well-known principles [21, Chapter 3] to build a globally synchronous system in section 5.2, and finally compare the result with the two LTTA protocols in section 5.3.

## 5.1 Central Master Synchronization

In central master synchronization, a node’s local time reference is incremented by the nominal period  $T_n$  at every activation. A distinguished node, the *central master*, periodically sends the value of its local time to all other nodes. When a slave node receives this message, it corrects its local time reference according to the sent value and the transmission latency.

For the quasi-periodic architecture, and assuming the central master is directly connected to all other nodes, the maximum difference between local time references immediately after resynchronization depends on the difference between the slowest and the fastest message transmissions between the central master and slaves:

$$\Phi = \tau_{\max} + T_{\max} - \tau_{\min}.$$

Between synchronizations, local time references drift apart. The maximum divergence between any two clocks is  $\Gamma = 2\rho R$ . The delay between successive resynchronizations  $R$  is equal, at best, to the master’s activation period. The maximum drift rate  $\rho$  is, in our case,

$$\rho = \frac{T_{\max}}{T_n} - 1 = \frac{T_{\max} - T_{\min}}{T_{\max} + T_{\min}}.$$

The maximal precision of the clock synchronization is then

$$\Pi = \Phi + \Gamma.$$

## 5.2 The Global Clock Protocol

A global notion of time can be realized by subsampling the local clock ticks of nodes provided the period of the global clock  $T_g$  is greater than the precision of the synchronization, that is,  $T_g > \Pi$ . This assumption is called the ‘reasonableness condition’ in [21, Chapter 3, § 3.2.1]. On any given node, the  $n$ th tick of the global clock occurs as soon as the local reference time is greater than  $nT_g$ . These particular ticks of the local clocks are called *macroticks*. Because of the reasonableness condition the delay between nodes activations that occur at the same macrotick is less than  $\Pi$ . Activating nodes on each of their macroticks thus naturally imposes a synchronous execution of the architecture.

Even with synchronization, a value from a faster node may still arrive at a slower one before the latter executes, overwriting the previous value before it can be read. A simple solution, adapted from the synchronous network model of [23, Chapter 2], is to establish separate communication and execution phases. There is, however, no need to execute twice for each activation of the machine. The lock-step execution means that no node can ever execute more than twice between any two activations of another. Communicating

$T_n$	$\tau_n$	$\varepsilon$	BP	TB	GC
$10^{-2}$	$10^{-6}$	1%	2.0	4.0	3.1
		5%	2.1	4.2	3.5
		15%	2.3	5.7	4.5
$10^{-4}$	$10^{-4}$	1%	4.0	6.1	3.2
		5%	4.2	6.3	3.8
		15%	4.6	10.3	5.4
$10^{-6}$	$10^{-2}$	1%	2.0	2.1	1.1
		5%	2.1	2.7	1.3
		15%	2.3	4.6	1.9

Figure 7: Relative worst case slowdowns for the different protocols: Back-Pressure (BP), Time-Based (TB) and Global Clock (GC), compared to an ideal synchronous execution.

through two-place buffers suffices to ensure that messages are never overwritten.

Finally, the transmission delay may prevent a value sent at the  $k$ th macrotick from arriving before the  $(k+1)$ th macrotick begins. From the maximum transmission delay, we can calculate the number of macroticks  $m$  that a node must wait to sample a new value with certainty:

$$m = \left\lceil \frac{\tau_{\max}}{T_g} \right\rceil + 1.$$

This means that the Kahn semantics of an application is preserved if nodes execute one step every  $m$  macroticks and communicate through buffers of size two. This gives a worst case throughput of

$$\lambda_{GC} = 1/mT_g. \quad (9)$$

We call this simple scheme the *Global-Clock protocol*.

## 5.3 Comparative Evaluation

Each of the three protocols entails some overhead in application execution time compared to an ideal scheme where  $T_{\min} = T_{\max}$  and  $\tau_{\min} = \tau_{\max}$ . To give a quantitative impression of their different performance characteristics, we instantiate in figure 7 the worst-case throughputs of the protocols—theorems 4 and 7 and equation (9)—to calculate the slowdown relative to the ideal case for three different architecture classes, from the top: slower nodes/faster communication, comparable nodes and communication, faster nodes/slower communication. In each class, we consider three different jitter values ( $\varepsilon$ ) applied to both the nominal period ( $T_n$ ) and transmission delay ( $\tau_n$ ). The slowdown is the relative application speed for a given architecture and protocol: 1.0 indicates the same speed as an ideal system; 2.0 means twice as slow.

The Global-Clock protocol performs better than both LTTA protocols when the activation period is much less than the transmission delay. In this case, the cost of clock synchronization is negligible and lock-step execution with two-place buffers maximizes application activations. Conversely, when the activation period is much greater than the transmission delay, the Back-Pressure protocol, which does not require node synchronization, performs best.

The Back-Pressure protocol is the least sensitive to jitter as it reacts as soon as fresh values are detected, while the other protocols must wait. The Time-Based protocol is especially sensitive, its performance decreases rapidly as jitter increases.

The slower nodes/faster communication architecture is the closest to the domain we consider (critical control applications). In this case, the Back-Pressure protocol achieves the best worst-case throughput, especially if there is significant jitter, but it does so by introducing inter-node control dependencies. Otherwise the Global-Clock protocol outperforms both others. Note, though, that we consider a simplified and optimistic case; realistic distributed clock synchronization algorithms will have higher overhead. The Time-Based protocol always has the biggest worst-case slowdown, but it is the least intrusive in terms of additional control logic.

## 6. CONCLUSION

In this paper, we presented the *Back-Pressure* and *Time-Based* LTTA protocols in a unified synchronous framework. This gives both a precise description of the implementation of synchronous applications over quasi-periodic architectures, and also permits the direct compilation of protocol controllers together with application functions. The Time-Based protocol that we present is simpler than previously published versions. We show that the Kahn semantics of synchronous applications implemented on quasi-periodic architectures is preserved by both protocols. Finally, we give bounds on the worst-case throughput for the protocols.

The comparison with an optimistic implementation of clock synchronization shows that the LTTA protocols are at least competitive for jittery architectures where the transmission delay is not significant relative to node periods—exactly the class of embedded systems of interest. In addition, the Time-Based protocol is noninvasive and robust: nodes need only listen and wait.

### Acknowledgements.

We thank Marc Pouzet and Adrien Guatto for their valuable comments. We also thank Gérard Berry, for the challenging remarks that motivated the comparisons of section 5, and the anonymous reviewers, for their useful suggestions.

## 7. REFERENCES

- [1] G. Baudart, A. Benveniste, A. Bouillard, and P. Caspi. A unifying view of Loosely Time-Triggered Architectures. Technical Report RR-8494, INRIA, 2014. Corrected version of [2].
- [2] A. Benveniste, A. Bouillard, and P. Caspi. A unifying view of Loosely Time-Triggered Architectures. In *EMSOFT'10*, pages 189–198, 2010.
- [3] A. Benveniste, P. Caspi, M. Di Natale, C. Pinello, A. Sangiovanni-Vincentelli, and S. Tripakis. Loosely Time-triggered Architectures based on Communication-by-sampling. In *EMSOFT'07*, pages 231–239, 2007.
- [4] A. Benveniste, P. Caspi, S. A. Edwards, N. Halbwachs, P. Le Guernic, and R. De Simone. The synchronous languages 12 years later. *Proc. IEEE*, 91(1):64–83, 2003.
- [5] A. Benveniste, P. Caspi, P. Le Guernic, H. Marchand, J.-P. Talpin, and S. Tripakis. A protocol for Loosely Time-Triggered Architectures. In *EMSOFT'02*, pages 252–265, 2002.
- [6] T. Bourke and M. Pouzet. Zélus: A synchronous language with ODEs. In *HSCC'13*, pages 113–118.
- [7] L. P. Carloni. The role of back-pressure in implementing latency-insensitive systems. *ENTCS*, 146(2):61–80, 2006.
- [8] L. P. Carloni, K. L. McMillan, and A. L. Sangiovanni-Vincentelli. Theory of latency-insensitive design. *IEEE Trans. on CAD of Integrated Circuits and Systems*, 20(9):1059–1076, 2001.
- [9] L. P. Carloni and A. L. Sangiovanni-Vincentelli. Coping with latency in SoC design. *IEEE Micro*, 22(5):24–35, 2002.
- [10] P. Caspi. The quasi-synchronous approach to distributed control systems. Technical Report CMA/009931, VERIMAG, Crysis Project, 2000.
- [11] P. Caspi and A. Benveniste. Time-robust discrete control over networked Loosely Time-Triggered Architectures. In *CDC'08*, pages 3595–3600, 2008.
- [12] P. Caspi, A. Girault, and D. Pilaud. Distributing reactive systems. In *PDCS '94*, pages 101–107, 1994.
- [13] J. C. Corbett, J. Dean, M. Epstein, A. Fikes, C. Frost, J. Furman, S. Ghemawat, A. Gubarev, C. Heiser, P. Hochschild, et al. Spanner: Google's globally distributed database. In *OSDI'12*, pages 261–264, 2012.
- [14] J. Cortadella and M. Kishinevsky. Synchronous elastic circuits with early evaluation and token counterflow. In *DAC'07*, pages 416–419, 2007.
- [15] J. Cortadella, A. Kondratyev, L. Lavagno, and C. P. Sotiriou. Desynchronization: Synthesis of asynchronous circuits from synchronous specifications. *IEEE Trans. on CAD of Integrated Circuits and Systems*, 25(10):1904–1921, 2006.
- [16] Esterel Technologies. Scade suite. <http://www.esterel-technologies.com/products/scade-suite/>.
- [17] N. Halbwachs and S. Baghdadi. Synchronous modelling of asynchronous systems. In *EMSOFT'02*, pages 240–251, 2002.
- [18] N. Halbwachs, P. Caspi, P. Raymond, and D. Pilaud. The synchronous dataflow programming language Lustre. *Proc. IEEE*, 79(9):1305–1320, 1991.
- [19] N. Halbwachs and L. Mandel. Simulation and verification of asynchronous systems by means of a synchronous model. In *ACSD'06*, pages 3–14, 2006.
- [20] G. Kahn. The semantics of a simple language for parallel programming. In *IFIP'74*, pages 471–475, 1974.
- [21] H. Kopetz. *Real-time systems: design principles for distributed embedded applications*. Springer-Verlag, 2nd edition, 2011.
- [22] K. Lee and J. C. Eidson. IEEE 1588-standard for a precision clock synchronization protocol for networked measurement and control systems. In *SIcon'02*, pages 98–105, 2002.
- [23] N. A. Lynch. *Distributed Algorithms*. Morgan Kaufmann, 1996.
- [24] F. Maraninchi and Y. Rémond. Argos: an automaton-based synchronous language. *Computer Languages*, 27(1–3):61–92, 2001.
- [25] D. L. Mills. *Computer Network Time Synchronization: The Network Time Protocol*. Taylor & Francis, 2006.
- [26] S. Tripakis, C. Pinello, A. Benveniste, A. Sangiovanni-Vincentelli, P. Caspi, and M. Di Natale. Implementing synchronous models on Loosely Time Triggered Architectures. *IEEE Trans. on Comp.*, 57(10):1300–1314, 2008.

## APPENDIX

### A. ZÉLUS SURVIVAL KIT

Zélus [6] is a first-order dataflow synchronous language extended with ODEs and hierarchical automata. We present here the basic syntax of its key features.<sup>6</sup>

#### A.1 Discrete time

The keyword **node** indicates a discrete stream function. For instance the following function initializes a counter with the value *i* and increments it at each step:

```
let node nat (i) = o where
  rec o = i → (pre o + 1)
```

```
val nat : int  $\xrightarrow{D}$  int
```

where the operators **pre**(.), the non-initialized unit delay, and  $\cdot \rightarrow \cdot$ , for initialization, are from Lustre. Applying this function to the constant 0 yields the execution:

<i>i</i>	0	0	0	0	0	0	0	0	...
<i>o</i>	0	1	2	3	4	5	6	7	...

The previous example can be rewritten using a *memory*.

```
let node nat_mem (i) = o where
  rec init o = i
  and o = last o + 1
```

```
val nat_mem : int  $\xrightarrow{D}$  int
```

The keyword **init** initializes a memory and the operator **last**(.) refers to its previous value.

The language has *valued signals* built and accessed through the constructions **emit** and **present**. Consider the program:

```
let node positive (i) = s where
  rec present i(v) → do emit s = (v > 0) done
```

```
val positive : int signal  $\xrightarrow{D}$  bool signal
```

Whenever a value *v* is emitted on signal *i*, signal *s* is emitted with value (*v* > 0). A signal is absent if not explicitly emitted.

Complicated behaviors are often best described as automata whose defining equations at an instant are mode-dependent. An automaton is a collection of states and transitions. There are two kinds of transitions: *weak* (written **until**) and *strong* (written **unless**). Consider the following example.

```
let node edge_strong (x) = o where
  rec automaton
    | Wait → do o = false unless (x = 0) then Found
    | Found → do o = true done
```

```
val edge_strong : int  $\xrightarrow{D}$  bool
```

Starting in state *Wait*, the output *o* is defined by the equation *o* = *false* while the condition (*x* = 0) is *false*. At the instant that this condition is *true*, *Found* becomes the active state and the output is thereafter defined by the equation *o* = *true*.

<i>x</i>	3	1	2	0	-1	0	...
<i>o</i>	<i>false</i>	<i>false</i>	<i>false</i>	<i>true</i>	<i>true</i>	<i>true</i>	...

Weak transitions introduce a delay between the instant when a transition guard becomes *true* and the instant when the mode changes.

<sup>6</sup>More details can be found at <http://zelus.di.ens.fr/>.

```
let node edge_weak (x) = o where
  rec automaton
    | Wait → do o = false until (x = 0) then Found
    | Found → do o = true done
```

```
val edge_weak : int  $\xrightarrow{D}$  bool
```

<i>x</i>	3	1	2	0	-1	0	...
<i>o</i>	<i>false</i>	<i>false</i>	<i>false</i>	<i>false</i>	<i>true</i>	<i>true</i>	...

#### A.2 Continuous Time

Zélus combines two models of time: *discrete* and *continuous*. Continuous time functions are introduced by the keyword **hybrid**.

```
let hybrid sawtooth () = s where
  rec der t = 2.0 init -1.5 reset up(last t) → -1.0
  and present up(t) → do emit s = () done
```

```
val sawtooth : unit  $\xrightarrow{C}$  unit signal
```

Variable *t* is defined by a differential equation with initial value -1.5 and derivative 2.0 using the **der** keyword. At zero-crossing instants—when the **last** *t* expression monitored by the **up**(.) operator passes through zero from a negative value to a positive one—*t* is reset to -1.0 and the signal *s* is emitted. The expression **last** *t* refers to the left-limit of signal *t*. It is needed here to avoid a causality loop.

Discrete functions can be activated on the presence of signals produced by continuous functions.

```
let hybrid simu () = o where
  rec init o = 0
  and s = sawtooth()
  and present s() → do o = nat(0) done
```

```
val simu : unit  $\xrightarrow{C}$  int
```

A memory *o* is initialized with value 0. Then at each of the events produced by the continuous function *sawtooth*, the new value of *o* is computed by the discrete function *nat*, otherwise the last computed value is maintained.

## B. OVERWRITES AND OVERSAMPLES

PROPERTY 1. *Given a pair of nodes executing and communicating according to definition 1, the maximum number of consecutive oversamplings and overwritings is*

$$n_{os} = n_{ow} = \left\lceil \frac{T_{max} + \tau_{max} - \tau_{min}}{T_{min}} \right\rceil - 1. \quad (3)$$

PROOF. Consider a pair of nodes *W* and *R* where *R* reads values sent by *W*. An oversampling occurs at each execution of *R* that occurs between the arrivals of two successive messages from *W*. The number of oversamples is maximal when the delay between the two arrivals is maximal. At best, the first value is received after the shortest possible transmission delay, that is after  $\tau_{min}$ . Then the next publication occurs at worst  $T_{max}$  after the first one and is received  $\tau_{max}$  later. Hence the maximum delay between two consecutive receptions is

$$T_{max} + \tau_{max} - \tau_{min}.$$

The number of oversamples is maximized by considering that *R* executes just after the arrival of the first message and then executes as fast as possible, that is, every  $T_{min}$ . Each execution of *R* that occurs before the arrival of the

next message oversamples the last received value. Thus the maximum number of executions  $n$  of  $R$  is such that

$$nT_{\min} \leq T_{\max} + \tau_{\max} - \tau_{\min}.$$

The maximum number of oversamples  $n_{os} = n - 1$  is thus given by equation (3).

On the other hand, an overwrite occurs each time a value sent by  $W$  is received between two successive executions of  $R$ . Suppose a first publication occurs at time  $t$ . In the worst case, the message is received  $\tau_{\max}$  later. Then,  $W$  executes  $n$  times at the fastest possible rate to maximize the number of messages sent. Each reception of a message from  $W$  that occurs before the next activation of  $R$  overwrites the last received value. The last message is received in the best case at  $t + nT_{\min} + \tau_{\min}$ . Thus the maximum delay between the first reception and the last one is

$$nT_{\min} + \tau_{\min} - \tau_{\max}.$$

The number of overwrites is maximal when  $R$  executes just before the first reception, thus missing the first value, and then executes again as late as possible, that is,  $T_{\max}$  later. Thus the maximum number of receptions  $n$  is such that

$$nT_{\min} + \tau_{\min} - \tau_{\max} \leq T_{\max}.$$

The maximum number of overwrites  $n_{ow} = n - 1$  is thus also given by equation (3).  $\square$

## C. SEMANTICS EQUIVALENCY

**THEOREM 1.** *For Mealy machines, composed as described above, the synchronous semantics and the Kahn semantics are equivalent*

$$\llbracket m \rrbracket \approx \llbracket m \rrbracket^K.$$

**PROOF.** We use here the notation  $x :: xs \in \mathcal{V}^\infty$  to represent a stream of values, where  $x \in \mathcal{V}$  is the first value of the stream, and  $xs \in \mathcal{V}^\infty$  denotes the rest of the stream.

Let us first prove for  $n$ -tuples of streams of the same length that  $(\mathcal{V}^n)^\infty \approx (\mathcal{V}^\infty)^n$ . We define:

$$F : (\mathcal{V}^n)^\infty \rightarrow (\mathcal{V}^\infty)^n$$

$$F(x_1, \dots, x_n) :: (xs_1, \dots, xs_n) = (x_1 :: xs_1, \dots, x_n :: xs_n)$$

$$G : (\mathcal{V}^\infty)^n \rightarrow (\mathcal{V}^n)^\infty$$

$$G(x_1 :: xs_1, \dots, x_n :: xs_n) = (x_1, \dots, x_n) :: (xs_1, \dots, xs_n).$$

By construction, streams  $x_1 :: xs_1, \dots, x_n :: xs_n$  all have the same length. Hence,  $F \circ G = Id$  and  $G \circ F = Id$ .

This isomorphism can be lifted naturally to functions, and we obtain  $(\mathcal{V}^I)^\infty \rightarrow (\mathcal{V}^O)^\infty \approx (\mathcal{V}^\infty)^I \rightarrow (\mathcal{V}^\infty)^O$  for streams of the same length.

The Mealy machines of section 2.3 always consume and produce streams of the same length since the execution of a Mealy machine consumes all inputs at each step and produces all outputs. The two semantics are thus equivalent.  $\square$

## D. MODELING TRANSMISSION DELAY

Modeling transmission delays is difficult because, depending on the characteristics of the architecture, there may be several ongoing transmissions at the same time. Since we assume that the network preserves message order, the idea is to use a First In First Out (FIFO) queue to store the delays between successive message transmissions. The model in Zélus follows.

```
let hybrid delay2(c, tau_min, tau_max, eps) = dc where
  rec init q = empty()
  and init trans = false
  and init t = 0.0
  and present
    | c() & up(last t) →
      local tau, d in
        do if is_empty(last q) then do t = -. tau done
          else do q = enqueue(dequeue(last q), d)
                and t = -. front(last q) done
          and tau = arbitrary(tau_min, tau_max)
          and d = max(eps, tau -. sum(last q) +. last t)
          and emit dc = () done
    | c() →
      local tau, d in
        do if (last trans) then do q = enqueue(last q, d) done
          else do t = -. tau
                and trans = true done
          and tau = arbitrary(tau_min, tau_max)
          and d = max(eps, tau -. sum(last q) +. last t) done
    | up(last t) →
      do if is_empty(last q) then do trans = false done
        else do t = -. front(last q)
              and q = dequeue(last q) done
          and emit dc = () done
      else do der t = 1.0 done
```

*val delay2 : unit signal \* float \* float \* float  $\xrightarrow{c}$  unit signal*

The boolean flag `trans` is set to `true` if there is an ongoing transmission and `false` otherwise. A timer `t` is used to model transmission delays.

Whenever the clock of the sender `c` ticks, there are two possible cases. If there is no ongoing transmission, the timer is reset to an arbitrary value `-. tau` between `-.tau_min` and `-.tau_max` and variable `trans` is set to `true`. On the other hand, if there are ongoing transmissions, we enqueue the distance `d` between a new arbitrary transmission delay and the end of the last ongoing transmission, that is, the sum of the delays stored in the queue minus the current value of the timer (time already elapsed). Note that we impose a (small) minimal delay `eps` between successive transmissions which can be seen as the time required to write a new value in the memory.

When the timer reaches zero, a signal `dc` is emitted to mark the end of the transmission. Then there are two possible cases. If the queue is empty, there are no further pending transmissions and the variable `trans` is set to `false`. If the queue is not empty, the timer is reset to the first value of the queue and this first value is removed from the queue.

Finally, if the timer reaches zero at the same time as `c` ticks, we merge the two behaviors described above.

## E. THE PARTICULAR CASE OF BROADCAST COMMUNICATION

Both LTTA protocols implement lock-step execution of all nodes when every node receives messages from every other node, that is, if communications are broadcast.

In fact, when all nodes communicate by broadcast, there are simpler and more efficient alternatives to the Back-Pressure controllers. The idea of the Round-Based controller shown in figure 8, which is inspired by the synchronous network model described in [23], is to force a node to wait for messages from all other nodes before computing a new value. Then each node sends the last computed value and computes the next one. Thus, nodes together perform rounds of execution. The Zélus code is:

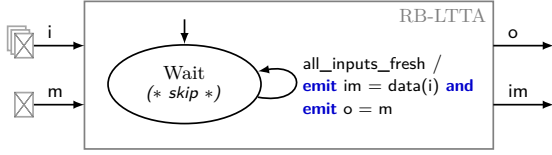

Figure 8: The Round-Based controller.

```

let node rb_controller (i, m) = (o, im) where
rec automaton
  | Wait →
    do (* skip *)
    unless all_inputs_fresh then
      do emit im = data(i) and emit o = m in Wait

```

```

and all_inputs_fresh = forall_fresh(i, im)

```

```

val rb_controller : 'a msg list * 'b  $\xrightarrow{D}$  'b signal * 'a list signal

```

As for the previous protocols, one can check that the composition of a Round-Based controller and a Mealy machine is always well-defined. The proof is similar to the one of theorem 2. The worst case dependency graph of a node controlled by the Round-Based protocol is:

$$o \leftarrow m \quad m \leftarrow om \quad om \leftarrow im \quad im \leftarrow i.$$

There is thus no dependency cycle.

### Preservation of the semantics.

Controllers like the Round-Based one induce a synchronous execution throughout an entire system. All nodes execute at approximately the same time. Unfortunately, at the start of a round, a value sent from a faster node may be received at a slower one and overwrite the last received value before the latter executes. A simple solution, based on the synchronous network model described in [23, Chapter 2], is to separate communication and execution phases. In this case, an application machine would execute every second round, but since lock-step execution ensures that no node can execute more than twice between two activations of any other, communication via buffers of size two ensures that messages are never overwritten even if applications are executed at every activation. Acknowledgments are not required.

### Performance bounds.

The worst case throughput of the Round-Based LTTA protocol is

$$\lambda_{RB} = 1/(\tau_{max} + T_{max}).$$

Indeed, suppose that the last execution of the  $(k-1)$ th round occurs at time  $t$ . In the worst case, a node notices the last publication and sends its new message at  $t + \tau_{max} + T_{max}$ . Thus, the last execution of the  $k$ th round occurs  $\tau_{max} + T_{max}$  after the last execution of the previous round.

### Timeout.

Like the Back-Pressure protocol, the Round-Based protocol uses blocking communication. If a node crashes, the entire application stops. To avoid such problems, a classic idea is to add timeouts. A local counter initialized to a value  $p$  is decremented at each tick of the local clock. A node executes when messages from all producers have been received or when the countdown reaches zero. Thus if a node crashes, the application keeps on computing in a degraded mode.

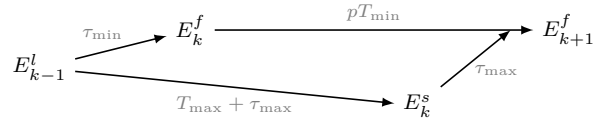

Figure 9: Explanation of the proof of property 6.

PROPERTY 6. *When the counter reaches zero, all messages will already have been received, provided that*

$$p > \frac{2\tau_{max} - \tau_{min} + T_{max}}{T_{min}}. \quad (10)$$

PROOF. Consider that the last send of the  $(k-1)$ th round occurs at some time  $t$ . The first sending of the  $k$ th round occurs at best at  $t + \tau_{min}$ . It corresponds to a node which receives the last message of the  $(k-1)$ th round after the shortest possible transmission delay and immediately executes at  $t + \tau_{min}$ . Then, assuming this node runs as fast as possible, it starts the next round  $pT_{min}$  later, that is, at  $t + \tau_{min} + pT_{min}$ .

On the other hand, in the worst case, the slowest node notices the last sending of the  $(k-1)$ th round and executes at  $t + \tau_{max} + T_{max}$ . The corresponding message is then received at latest another  $\tau_{max}$  later, that is, at  $t + 2\tau_{max} + T_{max}$ .

Thus, to ensure that all messages are received before the next round, it suffices to ensure that

$$\tau_{min} + pT_{min} > 2\tau_{max} + T_{max}.$$

Figure 9 gives a graphical illustration of the proof.  $\square$

## F. A COMPLETE EXAMPLE

We now present the complete source code of a small example with two nodes controlled by the Time-Based protocol. There are three files: `ltta.zls` contains the entire Zélus code, `misc.ml` contains external functions written in Ocaml, and `misc.zli` is the corresponding signature file for Zélus.

### ltta.zls.

```

open Misc

```

```

(** Modeling Quasi-periodic Architecturea **)

```

```

(** Bounds of Definition 1 **)

```

```

let t_min = 3.0

```

```

let t_max = 3.5

```

```

let tau_min = 0.1

```

```

let tau_max = 0.5

```

```

(** Quasi-periodic clocks **)

```

```

let hybrid metro (t_min, t_max) = c where

```

```

  rec der t = 1.0 init -. arbitrary (t_min, t_max)

```

```

    reset up(last t) → -. arbitrary (t_min, t_max)

```

```

    and present up(t) → do emit c = () done

```

```

(** Delayed clock. Model transmission delay **)

```

```

let hybrid delay(c, tau_min, tau_max) = dc where

```

```

  rec der t = 1.0 init 0.0

```

```

    reset c() → -. arbitrary (tau_min, tau_max)

```

```

    and present up(t) → do emit dc = () done

```

```

(** General Framework **)

```

```

(** Memory. Maintain the last received value on a signal *)

```

```

let node mem (i, default) = m where

```

```

  rec init m = default

```

```

  and present i(v) → do m = v done

```

```

(** Modeling links **)
let node channel (dc, i) = o where
  rec init q = empty()
  and trans = not (is_empty (last q))
  and present
    | dc() on trans & i(v) →
      do emit o = front (last q)
      and q = enqueue(dequeue(last q), v) done
    | dc() on trans →
      do emit o = front (last q)
      and q = dequeue (last q) done
    | i(v) →
      do q = enqueue (last q, v) done

(** Freshness of value **)
type 'a msg = {data : 'a; alt : bool}

let node alternate i = o where
  rec present i(v) → local flag in
    do flag = true → not (pre flag)
    and emit o = {data = v; alt = flag} done

let node fresh (i, r) = o where
  rec init m = false
  and present r(_) → do m = i.alt done
  and o = (i.alt <> last m)

let data v = v.data

(** LTTA links **)
let node ltta_link (dc, i, default) = o where
  rec s = channel (dc, i)
  and o = mem (alternate s, {data = default; alt = false})

(** Time-Based LTTA **)
(* Constants of thm 6 *)
let p =
  int_of_float (
    floor ((2. * tau_max +. t_max) /.
      t_min) +. 1.)

let q =
  int_of_float (
    floor ((tau_max +. (1. +. float (p)) * t_max) /.
      t_min -. float (p)) +. 1.)

(***) A small example (***)
(** The embedded application **)
let node machine1 () = n where
  rec n = 1 → (pre n + 2)

let node machine2 () = m where
  rec m = 0 → (pre m + 2)

(* Dummy link for nodes with no input *)
let node dummy_link () = {data = 0; alt = false}

(* LTTA nodes *)
let node ltta_n1 (i) = o where
  rec init n = 1
  and init m = 0
  and automaton
    | Wait →
      do n = p → (pre n - 1)
      unless (last n = 1) then
        do emit im = () in Ready
    | Ready →
      do n = q → (pre n - 1)
      unless ((last n = 1) or preempted) then
        do emit so = () in Wait
      and preempted = fresh(i, im)
      and present im() → do m = machine1() done
      and present so() → do emit o = m done

let node ltta_n2 (i) = o where
  rec init n = 1
  and init m = 0
  and automaton
    | Wait →
      do n = p → (pre n - 1)
      unless (last n = 1) then

```

```

      do emit im = () in Ready
    | Ready →
      do n = q → (pre n - 1)
      unless ((last n = 1) or preempted) then
        do emit so = () in Wait
      and preempted = fresh(i, im)
      and present im() → do m = machine2() done
      and present so() → do emit o = m done

(** Plugging two nodes with links to form an example **)
(* Note the activations of nodes on clock c1 and c2, *)
(* and the links on their delayed versions dc1 and dc2. *)
(* The output is the content of the links at each step. *)
let node example (c1, dc1, c2, dc2) = (o1, o2) where
  rec present c1() → do n = ltta_n1(l2) done
  and present c2() → do m = ltta_n2(l1) done
  and l0 = dummy_link()
  and l1 = ltta_link(dc1, n, 0)
  and l2 = ltta_link(dc2, m, 0)
  and o1 = l1.data
  and o2 = l2.data

(** Simulation **)
let hybrid main () = () where

  (* Architecture constraints *)
  rec c1 = metro(t_min, t_max)
  and dc1 = delay(c1, tau_min, tau_max)
  and c2 = metro(t_min, t_max)
  and dc2 = delay(c2, tau_min, tau_max)

  (* Global clock *)
  and present c1() | dc1() | c2() | dc2() → do emit g = () done

  and present g() → local o1, o2 in
    (* Run the example *)
    do (o1, o2) = example(c1, dc1, c2, dc2)
    and _ = print (o1, o2) done

```

## misc.ml.

```

(* Random generator *)
let arbitrary min max =
  (Random.float (max -. min)) +. min

(* Queue API *)
let empty () = []
let front l = List.hd (List.rev l)
let dequeue l = List.tl l
let enqueue l i = i::l
let sum l = List.fold_left (+.) 0.0 l
let is_empty l = (l == [])

(* Print *)
let print o1 o2 =
  Format.printf "o1 = %d, o2 = %d\n" o1 o2;
  Format.print_flush ()

```

## misc.zli.

```

val arbitrary : float * float → float
val empty : unit → 'a list
val front : 'a list → 'a
val dequeue : 'a list → 'a list
val enqueue : 'a list * 'a → 'a list
val sum : float list → float
val is_empty : 'a list → bool
val unsafe_print : int * int → unit

```