



HAL
open science

Adinkras for Mathematicians

Yan X. Zhang

► **To cite this version:**

Yan X. Zhang. Adinkras for Mathematicians. 25th International Conference on Formal Power Series and Algebraic Combinatorics (FPSAC 2013), 2013, Paris, France. pp.457-468. hal-01229733

HAL Id: hal-01229733

<https://inria.hal.science/hal-01229733v1>

Submitted on 17 Nov 2015

HAL is a multi-disciplinary open access archive for the deposit and dissemination of scientific research documents, whether they are published or not. The documents may come from teaching and research institutions in France or abroad, or from public or private research centers.

L'archive ouverte pluridisciplinaire **HAL**, est destinée au dépôt et à la diffusion de documents scientifiques de niveau recherche, publiés ou non, émanant des établissements d'enseignement et de recherche français ou étrangers, des laboratoires publics ou privés.

Adinkras for Mathematicians

Yan X Zhang[†]

Department of Mathematics, MIT, Cambridge, MA 02139, USA

Abstract. *Adinkras* are graphical tools created for the study of supersymmetry representations. Besides having inherent interest for physicists, the study of adinkras has already shown connections with coding theory and Clifford algebras. Furthermore, adinkras offer many natural and accessible mathematical problems of combinatorial nature. We present the foundations for a mathematical audience, make new connections to other fields (homological algebra, poset theory, and polytopes), and solve some of these problems. Original results include the enumeration of all hypercube adinkras through dimension 5, the enumeration of odd dashings of adinkras for any dimension, and a connection between rankings and the chromatic polynomial for certain graphs.

Résumé.

Les *adinkras* sont des dessins qui sont utilisés pour étudier les représentations des théories supersymétriques. Outre leur intérêt en physique, les adinkras sont aussi utiles en connexion avec la théorie des codes et les algèbres de Clifford. De plus, les adinkras offrent beaucoup de problèmes de nature combinatoire qui sont à la fois naturels et accessibles. Nous présentons une introduction pour une audience de mathématiciens, présentons de nouvelles connexions avec d'autres domaines (algèbres homologiques, ensembles partiellement ordonnés, polyèdres), et résolvons certains problèmes. Parmi les résultats nouveaux, nous énumérons les adinkras de l'hypercube de dimension inférieure ou égale à 5, nous énumérons les *odd dashings* en toute dimension, et établissons une relation entre les *rankings* et le polynôme chromatique pour certains graphes.

Keywords: supersymmetry, representation theory, Clifford algebras, codes, topology

1 Introduction

In a series of papers, starting with Faux and Gates Jr (2005) and most recently Doran et al. (2011), different subsets of the “DFGHILM collaboration” (Doran, Faux, Gates, Hübsch, Iga, Landweber, Miller) have built and extended the machinery of *adinkras*. Following the ubiquitous spirit of visual diagrams in physics, adinkras are combinatorial objects that encode information about the representation theory of supersymmetry algebras. Adinkras have many intricate links with other fields such as graph theory, Clifford theory, and coding theory. Each of these connections provides many problems that can be compactly communicated to a (non-specialist) mathematician. In this paper, which is an extended abstract for a longer article (Zhang (2011)) and more recent results (mostly from Klein and Zhang), we extract and study some of these mathematical problems.

[†]Supported by an NSF Graduate Fellowship

In short, *adinkras* are *chromotopologies* (a class of edge-colored bipartite graphs) with two additional structures, a *dashing* condition on the edges and a *ranking* condition on the vertices. We redevelop the foundations in a self-contained manner in Sections 2, and an optional discussion of the relevant physics in Section 3.

Using this setup, we look at the two aforementioned conditions separately in Sections 5 and 6, making original connection with different areas of mathematics. In Section 5 we use homological algebra to study dashings; our main result is the enumeration of odd dashings for any chromotopology. In Section 6, we use the theory of posets to put a lattice structure on the set of all rankings of any bipartite graph (including chromotopologies) and count hypercube rankings up through dimension 5. We discuss the generalization of rankings in Section 7, including a useful definition of *discrete Lipschitz functions*, a formula for rankings involving the chromatic polynomial, and a connection with the theory of polytopes.

We wish that these purely combinatorial discussions will equip the readers with a visual model that allows them to appreciate (or to solve!) the original representation-theoretic problems in the physics literature. We revisit these questions in Section 8, where we give our concluding remarks.

2 Definitions

In this section, we deviate from the original literature, yielding slightly cleaner and more general mathematics, but the core ideas are the same.

For a graph G , we use $E(G)$ to denote the edges of G and $V(G)$ to denote the vertices of G . We assume basic notions of posets and lattices, as in Stanley (1997). In this paper, we think of each Hasse diagram for a poset as a directed graph, with $x \rightarrow y$ an edge if y covers x . Thus it makes sense to call the maximal elements (i.e. those x with no $y > x$) *sinks* and the minimal elements *sources*. A *ranked* poset (this is sometimes also called a *graded* poset, though there subtly different uses of that name so we avoid it) is a poset A equipped with a rank function $h: A \rightarrow \mathbb{Z}$ such that for all x covering y we have $h(x) = h(y) + 1$. There is a unique rank function h_0 among these such that 0 is the lowest value in the range of h_0 , so it makes sense to define the *rank* of an element v as $h_0(v)$. The largest element in the range of h_0 is then the length of the longest chain in A ; we call it the *height* of A .

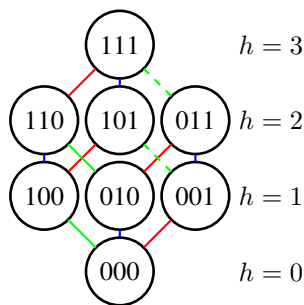

Fig. 1: An adinkra. We can take $\{000, 011, 101, 110\}$ to be either bosons or fermions.

An n -dimensional *adinkra topology*, or *topology* for short, is a finite, simple, connected, and bipartite graph A such that A is n -regular (every vertex has exactly n incident edges). We call the two sets in

the bipartition of $V(A)$ bosons and fermions, though the actual choice is mostly arbitrary and we do not consider it part of the data. A *chromotopology* of dimension n is a topology A such that the edges are colored by n colors, which are elements of the set $[n] = \{1, 2, \dots, n\}$ unless denoted otherwise, such that every vertex is incident to exactly one edge of each color, and for any distinct i and j , the edges in $E(A)$ with colors i and j form a disjoint union of 4-cycles.

An *adinkra* is a chromotopology A with two additional properties:

1. **ranked:** we give A the additional structure of a ranked poset, with rank function h_A (though we will usually just write h). In this paper, we will usually represent ranks via vertical placement, with higher h corresponding to being higher on the page.
2. **dashed:** we add an *odd dashing* A , which is a choice of making each edge of A either *dashed* or *solid*, such that every 2-colored 4-cycle contains an odd number of dashes.

An example of an adinkra is in Figure 1. Note that any chromotopology A can be ranked as follows: take one choice of bipartition of $V(A)$ into bosons and fermions. Assign the rank function h to take values 0 on all bosons and 1 on all fermions, forming a height-2 poset. Call such a ranked chromotopology a *valise* (see Figure 2). Thus, a chromotopology can be made into an adinkra if and only if it can be dashed. Call such chromotopologies *adinkraizable*.

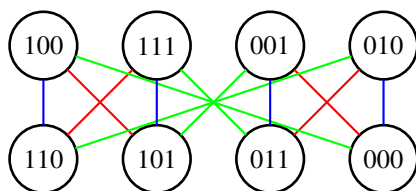

Fig. 2: A valise with topology I^3 .

3 Motivation

We have neither the space nor the qualification to give a comprehensive review, so we encourage interested readers to explore the original physics literature. The reader is already equipped to understand most of the rest of the paper without needing to read this section.

The physical motivation for adinkras is to understand off-shell representations of the N -extended Poincaré superalgebra in the 1-dimensional worldline. There is no need to understand what all of these terms mean (the author certainly does not) to appreciate the rest of the discussion; we now give a simplified translation.

We consider the algebra $\mathfrak{po}^{1|N}$ generated by $N + 1$ operators Q_1, Q_2, \dots, Q_N (the *supersymmetry generators*) and $H = i\partial_t$ (the *Hamiltonian*), such that $\{Q_I, Q_J\} = 2\delta_{IJ}H$ and $[Q_I, H] = 0$. Since H is basically a time derivative, it lowers the *engineering dimension* (physics units) of any function f by a single unit of time. Consider functions (equipped with engineering dimensions) $\{\phi_1, \dots, \phi_m\}$ (the *bosonic fields* or *bosons*) and $\{\psi_1, \dots, \psi_m\}$ (the *fermionic fields* or *fermions*), collectively called the *component fields*. We want to understand representations of $\mathfrak{po}^{1|N}$ acting on the infinite basis $\{H^k\phi_I, H^k\psi_J \mid k \in \mathbb{Z}\}$.

$\mathbb{N}; I, J \leq m\}$. This is a long-open problem and seems intractible, so we restrict our attention to one where the Q_I act as permutations (up to a scalar) on the basis: for any boson ϕ and any $Q_I, Q_I\phi = \pm(-iH)^s\psi$, where $s \in \{0, 1\}$, the sign, and the fermion ψ depends on ϕ and I . We enforce a similar requirement for fermions. We call the representations corresponding to these types of actions *adinkraic representations*. For each of these representations, we associate an *adinkra* via the following correspondence with the definitions in Section 2.

| adinkras | representations |
|-------------------------------------|--|
| vertex bipartition | bosonic/fermionic bipartition |
| rank function (refines bipartition) | partition of component fields by engineering dimension |
| edge with color I | Q_I action without the sign or powers of $(-iH)$ |
| dashing of an edge | sign in Q_I action |
| change of rank by an edge | powers of $(-iH)$ in Q_I action |

To summarize: an adinkra encodes a representation of $\mathfrak{po}^{1|N}$. An adinkraic representation is a representation of $\mathfrak{po}^{1|N}$ that can be encoded into an adinkra.

When the poset structure of our adinkra A is a boolean lattice, we get what Doran et al. (2008a) calls the *exterior supermultiplet*, which coincides with the classical notion of the *superfield* introduced in Salam and Strathdee (1974). When A is a valise, we get Doran et al. (2008a)’s *Clifford supermultiplet*.

4 Topologies and Chromotopologies

In this section, we study chromotopologies and adinkraizable chromotopologies. Our approach is more general than the relevant sections of Doran et al. (2008a) and Doran et al. (2008b) and we obtain the main classification results of those papers as a special case, though all the main ideas, including the pleasant connections to codes and Clifford algebras, are already done in the original work.

We now give a quick review of codes (there are many references, including Huffman and Pless (2003)). An *n-bitstring* is a vector in \mathbb{Z}_2^n , which we usually write as $b_1b_2 \cdots b_n, b_i \in \mathbb{Z}_2$. We distinguish two *n-bitstrings* $\vec{1}_n = 11 \dots 1$ and $\vec{0}_n = 00 \dots 0$, and when n is clear from context we suppress the subscript n . The number of 1’s in a bitstring v is called the *weight* of the string, which we denote by $\text{wt}(v)$. An (n, k) -*linear binary code*, or *code* for short, is a k -dimensional subspace of \mathbb{Z}_2^n . A code is *even* if all its bitstrings have weight divisible by 2 and *doubly even* if all its bitstrings have weight divisible by 4.

Define the n -dimensional *hypercube* to be the graph with 2^n vertices labeled by the n -bitstrings. If two vertices differ at the i -th bit i , color the edge between them by i . This graph is a chromotopology, so we call it the n -*cubical chromotopology* I_c^n . Our earlier example in Figure 1 had the chromotopology I_c^3 . The hypercube is the main running example in this paper. We denote the underlying (colorless) graph of I_c^n as I^n .

For a code L , we now construct an edge-colored graph I_c^n/L , which we call the *quotient* of I_c^n by L . Let $V(I_c^n/L)$ be the set of the equivalence classes of \mathbb{Z}_2^n/L and define $p_L(v)$ as the image of v under the quotient \mathbb{Z}_2^n/L . Let there be an edge $p_L(v, w)$ in I_c^n/L with color i between $p_L(v)$ and $p_L(w)$ in I^n/L if there is at least one edge with color i of the form (v', w') in \mathbb{Z}_2^n , with $v' \in p_L^{-1}(v)$ and $w' \in p_L^{-1}(w)$. It can be checked that I_c^n/L is a n -regular graph.

Proposition 4.1 *The following hold for $A = I_c^n/L$, where L is a code.*

1. A is a simple graph if and only if L has no bitstrings of weight 1 or 2.
2. A can be ranked if and only if A is bipartite, which is true if and only if L is an even code.
3. A can be dashed if and only if L is a code with the following two conditions: first, all bitstrings must have weight 0 or 1 (mod 4); second, for any two bitstrings w_1 and w_2 , we have $(w_1 \cdot w_2) + \text{wt}(w_1)\text{wt}(w_2) = 0 \pmod{2}$, where the first term is the dot product in \mathbb{Z}_2^n .

Proof idea: The first two parts are routine. The third can be proven by a translation of the dashed condition into relations in the multiplicative group of the signed monomials of the Clifford algebra $\text{Cl}(n)$. \square

These results give the following classifications, the second part being equivalent to a combination of (Doran et al., 2008a, Theorem 4.1) and (Doran et al., 2008b, Section 3.1):

Theorem 4.2 Chromotopologies are in bijection with quotients I_c^n/L where L is an even code with no bitstring of weight 2. Adinkraizable chromotopologies are in bijection with such quotients where L is a doubly even code.

Thanks to Theorem 4.2, we can assume that any chromotopology A we discuss comes from some (n, k) -code $L(A) = L$. If L is an (n, k) -code, we say that the corresponding A is an (n, k) -chromotopology. An $(n, 0)$ -chromotopology is exactly the n -cubical chromotopology, corresponding to the trivial code $\{\vec{0}\}$. The first non-cubical chromotopology, shown in Figure 3, is the result of quotienting the 4-cubical topology by the code $L = \{0000, 1111\}$, the smallest non-trivial doubly-even code. It has the topology of the bipartite graph $K_{4,4}$.

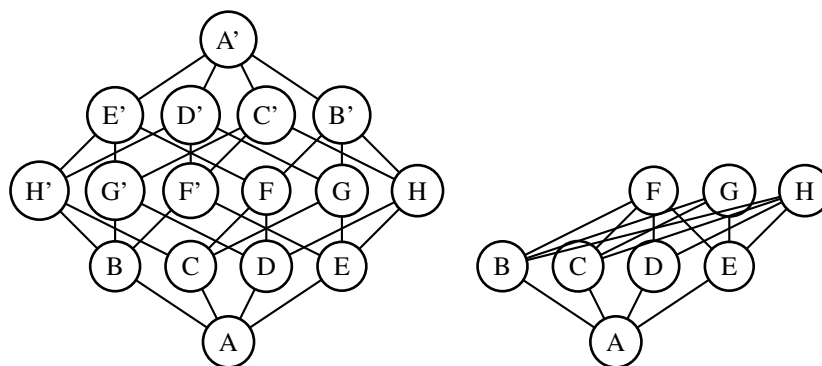

Fig. 3: The topologies I^4 and $I^4/\{0000, 1111\}$. Labels with the same letter are sent to the same vertex.

Before moving on, we introduce a helpful notion for later sections. Say that a color i decomposes a chromotopology A into A_0 and A_1 , or $A = A_0 \amalg_i A_1$, if removing all edges with color i creates two disjoint chromotopologies A_0 and A_1 , which are labeled and colored in a natural fashion. Whenever $A = A_0 \amalg_i A_1$, A_0 and A_1 are $(n - 1, k)$ chromotopologies with isomorphic topologies. Our definition was inspired by observations in Doran et al. (2008b), where certain adinkras were called 1-decomposable. See Figure 4 for an example.

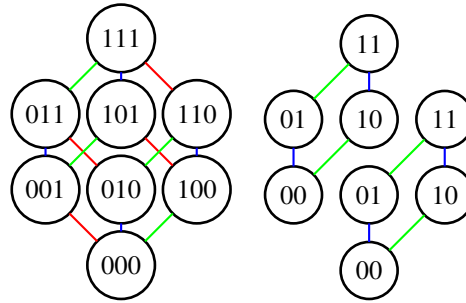

Fig. 4: The color 3 decomposes a ranked chromotopology A .

5 Dashing

Given an adinkraizable chromotopology A , define $o(A)$ to be the set of odd dashings of A . In this section, we introduce several seemingly unrelated ideas and combine them to count $|o(A)|$ for any adinkraizable chromotopology.

First, let an *even dashing* be a way to dash $E(A)$ such that every 2-colored 4-cycle contains an even number of dashed edges, and let $e(A)$ be the set of even dashings. The odd dashings form a torsor for the even dashings:

Lemma 5.1 *For any adinkraizable chromotopology A , we have $|o(A)| = |e(A)|$.*

Proof idea: Let $l = |E(A)|$. We may consider a dashing (with no parity constraints) of A as a vector in \mathbb{Z}_2^l , where each coordinate corresponds to an edge and is assigned 1 for a dashed edge and 0 for a solid edge. The obvious way to add dashings make all dashings form a vector space V of dimension l . Observe that $e(A)$ is a subspace of V , and that $o(A)$ is a coset in V of $e(A)$ and must then have the same cardinality as $e(A)$ given that at least one odd dashing exists. Since A is adinkraizable by definition, we are done. \square

Dashings (of both sorts) behave extremely well under decompositions. In fact, if $A = A_0 \amalg_i A_1$, then each even (resp. odd) dashing of the induced graph of A_0 and each of the arbitrary choices of dashing the i -colored edges extends to exactly one even (resp. odd) dashing of A . Using this and an inductive argument, we obtain:

Proposition 5.2 *The number of even (or odd) dashings of I_c^n is*

$$|e(I_c^n)| = |o(I_c^n)| = 2^{2^n - 1}.$$

We now borrow a concept from Douglas et al. (2010), which defines the *vertex switch* at a vertex v of a dashed chromotopology A as the operation that sends all dashed edges incident to v to solid edges, and vice-versa (this is in turn inspired by the theory of *two-graphs*). A vertex switch preserves odd dashings (in fact, parity in all 4-cycles), so the odd dashings of A can be split into orbits under vertex switches, which we will call the *labeled switching classes* (or *LSCs*) of A .

Proposition 5.3 *In an adinkraizable (n, k) -chromotopology, each LSC has $2^{2^{n-k} - 1}$ dashings.*

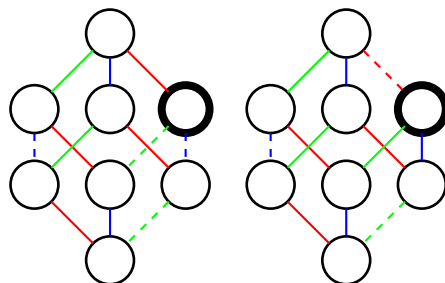

Fig. 5: Before and after a vertex switch at the outlined vertex.

We need a final observation. In Section 4, I_c^n plays the role of a universal cover, in the sense that its everything else comes from their quotients. We make this intuition rigorous with homological algebra. Over \mathbb{Z}_2 , construct the following 2-dimensional complex $X(A)$ from a chromotopology A . Let C_0 be formal sums of elements of $V(A)$ and C_1 be formal sums of elements of $E(A)$. For each 2-colored 4-cycle C of A , create a 2-cell with C as its boundary as a generator in C_2 , the boundary maps $\{d_i : C_i \rightarrow C_{i-1}\}$ are the natural choices (we do not worry about orientations since we are using \mathbb{Z}_2), giving homology groups $H_i = H_i(X(A))$.

Proposition 5.4 *Let A be an (n, k) -adinkraizable chromotopology with code L . Then $X(A) = X(I_c^n)/L$ as a quotient complex, where L acts freely on $X(I_c^n)$. We have that $X(I_c^n)$ is a simply-connected covering space of $X(A)$, with L the group of deck transformations.*

Finally, we combine all our ideas to generalize Theorem 5.2.

Theorem 5.5 *The number of even (or odd) dashings of an adinkraizable (n, k) -chromotopology A is*

$$|e(A)| = |o(A)| = 2^{2^{n-k} + k - 1}.$$

Proof idea: The even dashings are exactly the orthogonal complement of the boundaries in C_1 (by the usual inner product), which works out to have \mathbb{Z}_2 -dimension equalling $\dim(H_1) + \dim(C_0) - \dim(H_0)$. However, note that $\dim(C_0) - \dim(H_0) = 2^{n-k} - 1$, which is exactly the dimension of the vector space of the vertex switchings for a particular LSC from Proposition 5.3. Dividing, we get that the dimension of switching classes is precisely $\dim(H_1)$. By Proposition 5.4, $\pi_1(X(A)) = L$, the quotient group, which in this case is the vector space \mathbb{Z}_2^k . Since π_1 is abelian, $H_1 = \mathbb{Z}_2^k$ also. These dimensions basically complete the proof. \square

It is remarkable that this enumeration is dependent only on the dimension k of the code and not the code itself, a fact that was not obvious to us through elementary methods.

6 Ranking

Fix a chromotopology A . Call the set of all ranked chromotopologies with the same chromotopology as A the *rank family* $R(A)$ and the elements of $R(A)$ *rankings* of A . Figure 6 shows $R(I_c^2)$. In this section, we give some original structural results using the language of posets and lattices. Then, we count the rankings for I_c^n with $n \leq 5$ with the help of decomposition.

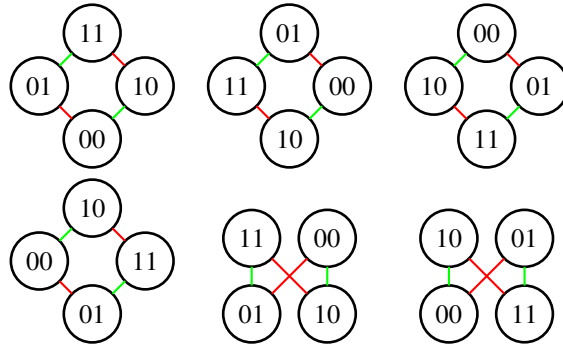

Fig. 6: The rank family of I^2 .

The main structural theorem for rankings is the following theorem. Let $D(v, w)$ be the graph distance function between v and w :

Theorem 6.1 (Doran et al., 2007, Theorem 4.1) *Fix a chromotopology A . Let $S \subset V(A)$ and $h_S: S \rightarrow \mathbb{Z}$ be such that h_S takes only odd values on bosons and only even values on fermions, or vice-versa, and for every distinct s_1 and s_2 in S , we have $D(s_1, s_2) > |h_S(s_1) - h_S(s_2)|$. Then, there exists a unique ranking of A , corresponding to the rank function h , such that h agrees with h_S on S and A 's set of sinks is exactly S .*

In other words, any ranking of A is determined by a set of sinks and their relative ranks (an analogous statement is true for sources). We can think of such a choice as the following: pick some nodes as sinks and “pin” them at acceptable relative ranks, and let the other nodes naturally “hang” down. Thus, Theorem 6.1 is also called the “Hanging Gardens” Theorem. Figure 7 shows an example.

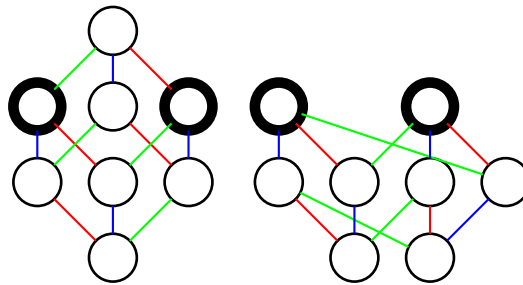

Fig. 7: Left: I^3 . Right: Hanging Gardens on I^3 applied to the two outlined vertices.

In particular, note that we can pick the set of sinks to contain only a single element, which defines a unique ranking. Thus, for any vertex v of a chromotopology A , by Theorem 6.1 we can get a ranking A^v which “hangs” from its only sink v . We now discuss our original results.

We introduce two operators on $R(A)$. Given a ranking B in $R(A)$ (with rank function h) and a sink s , we define D_s , the *vertex lowering* on s , to change $h(s)$ to $h(s) - 2$ while keeping everything else in B

unchanged (visually, we have “flipped” s down two ranks and its edges with it). We define U_s , the *vertex raising on s* , to be the analogous operation for s a source. We call both of these operators *vertex flipping operators*. In Doran et al. (2007), it is shown that any two rankings with the same chromotopology A can be obtained from each other via a sequence of vertex-raising or vertex-lowering operations, so $R(A)$ has the structure of a connected graph. We can say more about $R(A)$.

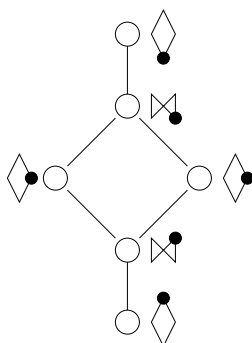

Fig. 8: The rank family poset for $P_v(I^2)$, where next to each node is a corresponding ranking. The rankings are presented as miniature posets, with the black dots corresponding to v .

Theorem 6.2 *For a chromotopology A and any vertex v of A , there exists a finite distributive symmetric ranked lattice $P_v(A)$ with vertex set $R(A)$. Each covering relation in $P_v(A)$ corresponds to vertex-flipping on some vertex $w \neq v$.*

Proof idea: Construct $P_v(A)$, as a ranked poset, in the following way: on the bottom rank 0 put A^v as the unique element. Once we finish constructing rank i , from any choice of element B on rank i and a source $w \in V(B) \setminus \{v\}$, apply U_w to obtain a ranking C and place it on rank $i + 1$ such that C covers B . The lattice structure comes from constructing an auxiliary poset $E_v(A)$, showing $P_v(A)$ is the poset of order ideals of $E_v(A)$, and appealing to the fundamental theorem of finite distributive lattices. \square

The authors of Doran et al. (2007) noted that the rank family is reminiscent of a Verma module. Extend the U_s to act on formal sums in $\mathbb{R}[R(A)]$ and define $U(A)$ to be the algebra generated by all $U_{s \in A}$. The image of A^v under the action of $U(A)/U_v$ is $\mathbb{R}[R(A)]$, so we can consider A^v as a lowest-weight vector. If we allowed U_v we would get repetitions as there would be a nontrivial product of U_s that would act as the identity on A^v .

Finally, we want to count the cardinality of $R(I^n)$. With the help of decomposition and some optimizations, we computed $|R(I^n)|$ with a computer program for $n \leq 5$. We include the results in Table 1 along with the counts of dashings and adinkras. Finding the answer for $n = 6$ seems intractible with an algorithm that is at least linear in the number of solutions. For chromotopologies other than $R(I^n)$, we can still perform similar computations with the help of decomposition. However, doing a case-by-case analysis for different chromotopologies seems uninteresting without unifying principles.

| n | dashings | rankings | adinkras |
|-----|------------|----------|-----------------|
| 1 | 2 | 2 | 4 |
| 2 | 8 | 6 | 48 |
| 3 | 128 | 38 | 4864 |
| 4 | 32768 | 990 | 32440320 |
| 5 | 2147483648 | 395094 | 848457904422912 |

Tab. 1: Enumeration of dashings, rankings, and adinkras with chromotopology I_C^n .

7 Generalizing Rankings and Discrete Lipschitz Functions

Rankings are easy to generalize directly to bipartite graphs since they do not rely on any other aspects of a chromotopology. Theorems 6.1 and 6.2 both hold for bipartite graphs as stated. In Klein and Zhang we study this generalization, obtaining exact enumerations for $R(G)$ for special families of graphs and constructing a (complicated) generating function whose constant term equals $R(G)$. However, our most interesting result is the following:

Theorem 7.1 (Klein and Zhang) *If the cycle space of G is generated by 4-cycles, then $|R(G)| = (1/3)\chi_A(3)$, where χ_A is the chromatic polynomial of G .*

Many families of graphs satisfy the conditions needed for Theorem 7.1, such as trees, hypercubes (but not their quotients!), and grid graphs. The main strategic advantage, however, is that Theorem 7.1 allows us to borrow techniques from the theory of Tutte/chromatic polynomials. Interestingly, the most promising tools come from statistical mechanics, a branch of physics quite distant from supersymmetry. In particular, the results found by Salas and Sokal in a series of papers (most relevantly Salas and Sokal (2009)) give data that supports our own calculations of $R(G)$ using the transfer-matrix method.

Finally, given a graph G with n vertices, consider the pairs of hyperplanes in \mathbb{R}^n created by $|x_i - x_j| = \pm 1$ for $(i, j) \in E(G)$. Now, if we fix any $x_i = 0$, we get an $(n-1)$ -dimensional polytope P_G . The integral points $P_G \cap \mathbb{Z}^n$ are exactly the functions $f: V(G) \rightarrow \mathbb{Z}$ such that $|f(i) - f(j)| \leq 1$ for $(i, j) \in E(G)$. It seems natural to call these integral functions *discrete Lipschitz functions*; almost identical definitions have occurred in other places, including Jiang and Chen (2011), where they were used to study the No Free Lunch Theorem. There are two seemingly unrelated connections between P_G and $R(G)$:

Theorem 7.2 (Klein and Zhang) *The following hold for a bipartite graph G :*

1. *The vertices of P_G are in bijection with the elements of $R(G)$.*
2. *We have $|P_G \times I \cap \mathbb{Z}^{2n-1}| = 2|R(G)|$.*

Besides contributing to this and potential further results about counting rankings, P_G and discrete Lipschitz functions seem very natural objects to study on their own: P_G is the dual polytope to a *root polytope* defined via the graph G , which has been studied in Mészáros (2011). Christian Stump and Vincent Pilaud (Pilaud and Stump) observed that P_G is a special instance of Lam and Postnikov's *alcoved polytopes* found in Lam and Postnikov (2007). Finally, exploring the Ehrhart theory of P_G may be worthwhile.

8 Concluding Remarks

Adinkras are beautiful objects that have given us some very natural mathematical problems where much remain to be done. For sake of brevity, several promising new directions and results have been omitted from this extended abstract. Besides generalizing rankings, we have also started generalizing dashings to arbitrary graphs, finding some similarities with the study of Pfaffian graphs. Recently, the authors of the original literature have used homological techniques to obtain an independent set of results from our own (see Doran et al. (2011)). In a different application of topology, we have obtained a promising notion of Stiefel-Whitney classes for a code and studied the conditions under which they vanish, to emulate obstruction-theoretic interpretations of Stiefel-Whitney classes.

Finally, while we have focused on the mathematics, many potential applications of adinkras to physics are not completely explored. We end with a sketch of the longer discussion in Zhang (2011).

- One may wish to ask which adinkraic representations are irreducible. In the valise case, this is well-understood (see Doran et al. (2008b)) with an elegant answer: irreducible valise adinkraic representations correspond to maximal doubly-even codes. However, there is currently no efficient method for other rankings.
- Even asking what it means for two adinkras to be isomorphic is a subtle question; while it seems to be completely intuitive for the authors of the literature (see Gates et al. (2009) and Douglas et al. (2010)), Zhang (2011) may be the first formal discussion. A natural continuation of this question is how to tell if two adinkras capture isomorphic adinkraic representations, which is not yet completely understood (but known for irreducible representations).
- It would be good to have a theory of adinkras as building blocks of more complex representations and representations of higher dimensions. For example, by direct sums, tensors, and other operations familiar to the Lie algebras setting, it is possible to construct many more representations (see Doran et al. (2008b)), a technique that has been extended to higher dimensions in Hübsch (2011).

Acknowledgements

First and foremost, we thank Sylvester “Jim” Gates for teaching the subject to us. We thank Brendan Douglas, Greg Landweber, Kevin Iga, Nathan Kaplan, Aaron Klein, Joel Lewis, Anatoly Preygel, Nick Rozenblyum, Steven Sam, and Richard Stanley for helpful discussions. We are especially grateful to Tristan Hübsch for his unreasonably generous gift of time and patience through countless communications. The author was supported by an NSF graduate research fellowship.

We also thank our two anonymous referees for their observations.

References

- C. F. Doran, M. G. Faux, S. J. Gates, Jr., T. Hübsch, K. M. Iga, and G. D. Landweber. On graph-theoretic identifications of Adinkras, supersymmetry representations and superfields. *Internat. J. Modern Phys. A*, 22(5):869–930, 2007. ISSN 0217-751X.
- C. F. Doran, M. G. Faux, S. J. Gates, Jr., T. Hübsch, K. M. Iga, G. D. Landweber, and R. L. Miller. Topology Types of Adinkras and the Corresponding Representations of N-Extended Supersymmetry, May 2008a. arXiv:hep-th/0806.0050.

- C. F. Doran, M. G. Faux, S. J. Gates, Jr., T. Hubsch, K. M. Iga, G. D. Landweber, and R. L. Miller. Adinkras for Clifford Algebras, and Worldline Supermultiplets, Nov. 2008b. arXiv:hep-th/0811.3410.
- C. F. Doran, M. G. Faux, S. J. Gates, Jr., T. Hubsch, K. M. Iga, G. D. Landweber, and R. L. Miller. Codes and supersymmetry in one dimension. *Advances in Theoretical and Mathematical Physics*, 15: 1909–1970, dec 2011.
- B. L. Douglas, S. J. Gates, Jr., and J. B. Wang. Automorphism Properties of Adinkras, Sept. 2010. arXiv:hep-th/1009.1449.
- M. G. Faux and S. J. Gates Jr. Adinkras: A graphical technology for supersymmetric representation theory. *PHYS.REVD*, 71:065002, 2005. arXiv:hep-th/0408004.
- S. J. Gates, Jr., J. Gonzales, B. Mac Gregor, J. Parker, R. Polo-Sherk, V. G. J. Rodgers, and L. Wassink. 4D, Script N = 1 supersymmetry genomics (I). *Journal of High Energy Physics*, 12, Dec. 2009. doi: 10.1088/1126-6708/2009/12/008.
- T. Hubsch. Weaving Worksheet Supermultiplets from the Worldlines Within, Apr. 2011. arXiv:hep-th/1104.3135.
- W. C. Huffman and V. Pless. *Fundamentals of error-correcting codes*. Cambridge University Press, Cambridge, 2003. ISBN 0-521-78280-5.
- P. Jiang and Y. Chen. Free lunches on the discrete lipschitz class. *Theoretical Computer Science*, 412 (17):1614 – 1628, 2011. ISSN 0304-3975. doi: 10.1016/j.tcs.2010.12.028. URL <http://www.sciencedirect.com/science/article/pii/S030439751000719X>.
- A. Klein and Y. X. Zhang. Enumerating graded poset structures on graphs. In preparation.
- T. Lam and A. Postnikov. Alcoved polytopes, i. *Discrete & Computational Geometry*, 38:453–478, 2007. ISSN 0179-5376. URL <http://dx.doi.org/10.1007/s00454-006-1294-3>.
- K. Mészáros. Root polytopes, triangulations, and the subdivision algebra, II. *Trans. Amer. Math. Soc.*, 363(11):6111–6141, 2011. ISSN 0002-9947. doi: 10.1090/S0002-9947-2011-05371-7. URL <http://dx.doi.org/10.1090/S0002-9947-2011-05371-7>.
- V. Pilaud and C. Stump. Private communication.
- A. Salam and J. Strathdee. Super-gauge transformations. *Nuclear Phys.*, B76:477–482, 1974. ISSN 0550-3213.
- J. Salas and A. D. Sokal. Transfer Matrices and Partition-Function Zeros for Antiferromagnetic Potts Models. V. Further Results for the Square-Lattice Chromatic Polynomial. *Journal of Statistical Physics*, 135:279–373, 2009.
- R. P. Stanley. *Enumerative combinatorics. Vol. 1*, volume 49 of *Cambridge Studies in Advanced Mathematics*. Cambridge University Press, Cambridge, 1997. ISBN 0-521-55309-1; 0-521-66351-2.
- Y. X. Zhang. Adinkras for Mathematicians, 2011. Submitted, arXiv:1111.6055.