



**HAL**  
open science

## Decision making mechanisms in a connectionist model of the basal ganglia

Charlotte Héricé, Radwa Khalil, Maria Moftah, Thomas Boraud, Martin Guthrie, André Garenne

► **To cite this version:**

Charlotte Héricé, Radwa Khalil, Maria Moftah, Thomas Boraud, Martin Guthrie, et al.. Decision making mechanisms in a connectionist model of the basal ganglia. The Multi-disciplinary Conference on Reinforcement Learning and Decision Making (RLDM 2015), Jun 2015, Edmonton, Canada. . hal-01206514

**HAL Id: hal-01206514**

**<https://inria.hal.science/hal-01206514v1>**

Submitted on 29 Sep 2015

**HAL** is a multi-disciplinary open access archive for the deposit and dissemination of scientific research documents, whether they are published or not. The documents may come from teaching and research institutions in France or abroad, or from public or private research centers.

L'archive ouverte pluridisciplinaire **HAL**, est destinée au dépôt et à la diffusion de documents scientifiques de niveau recherche, publiés ou non, émanant des établissements d'enseignement et de recherche français ou étrangers, des laboratoires publics ou privés.

## INTRODUCTION

Basal ganglia (BG) are known to hosts mechanisms of action selection and its adaptation to a changing environment. Their architecture consist of several parallel functional loops connecting back to distinct areas of cortex (motor, cognitive and limbic) and processing different modalities of decision making. The picture of parallel loops is complicated by partial convergence and divergence connections that implies that the various loops are interacting.

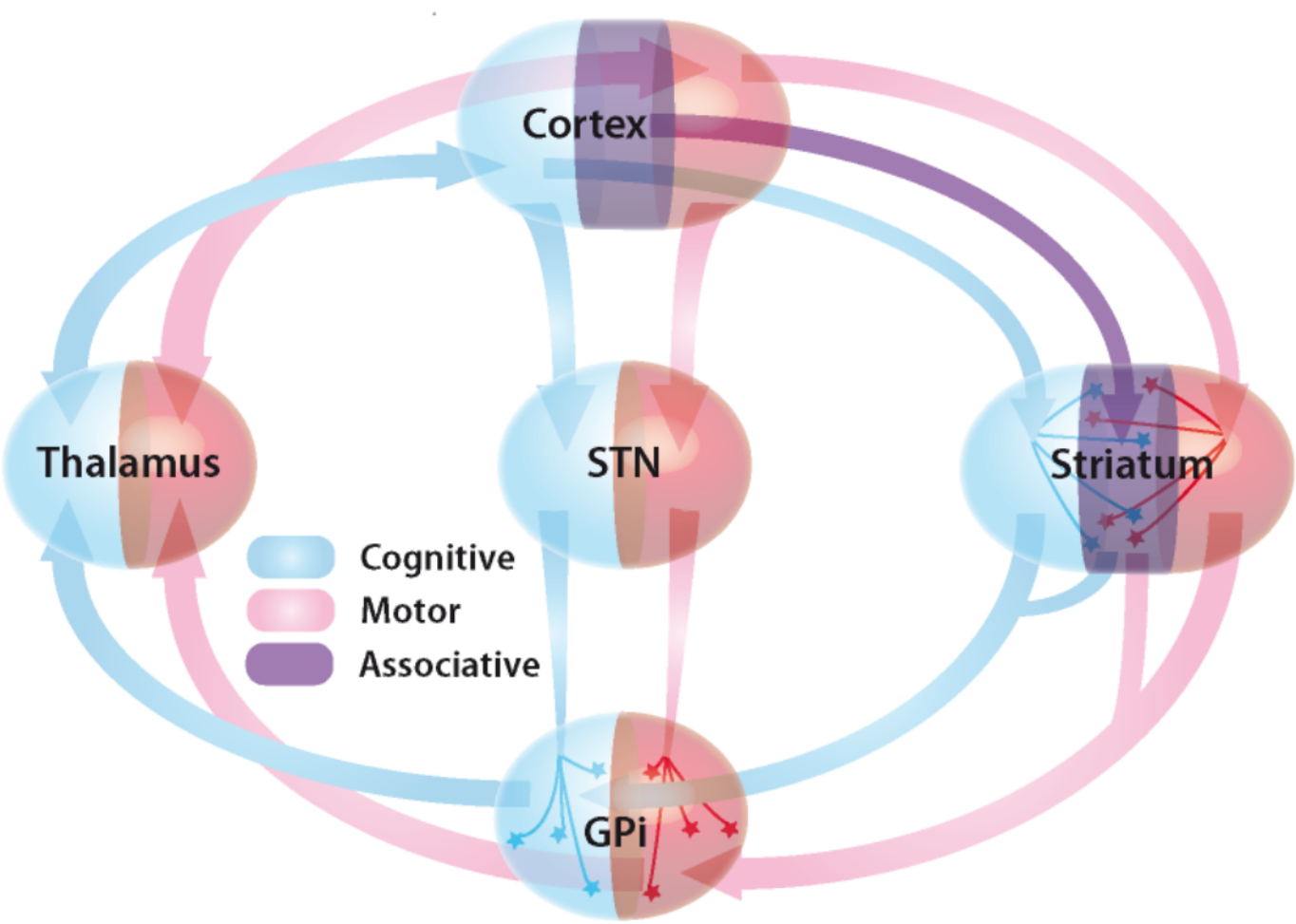

Figure 1. Overview of model architecture

A previous BG model (developed by M. Guthrie[1]) was built of interacting bloc-diagram based on rate-models. It was able to learn optimized action selection during a probabilistic reward task. The aim of the present work is to refine and extend these results to a cell-synapse level through a bottom-up approach:  
→ Highlighting of the structure-function relationship and circuitry emerging properties  
→ Investigation of cell-scale mechanisms impact on the whole model capacities (learning and decision-making)

## NETWORK ARCHITECTURE

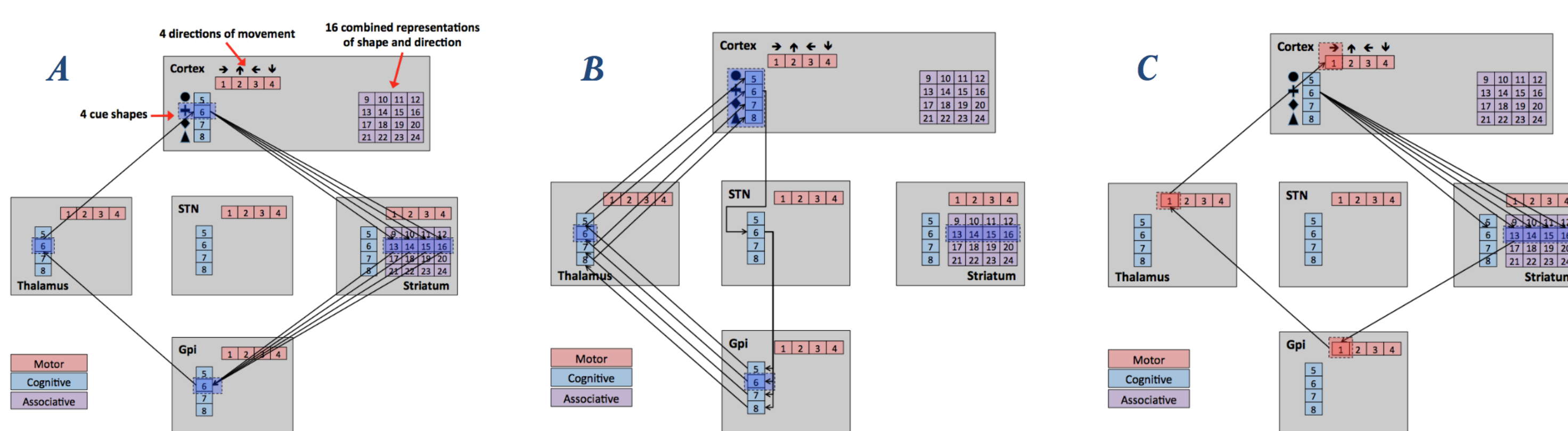

Figure 4. Model pathways. A) Direct pathway. B) Hyperdirect pathway. C) Pathway crosstalk

Leaky integrate-and-fire neuron model:  $C_m \cdot \frac{dV_m(t)}{dt} + \frac{V_m(t)}{R_m} = I(t)$

Learning takes place when a reward is obtained. It is implemented as an increase in the synaptic weights corresponding to the projection from the cognitive cortex to the striatum.

## RESULTS

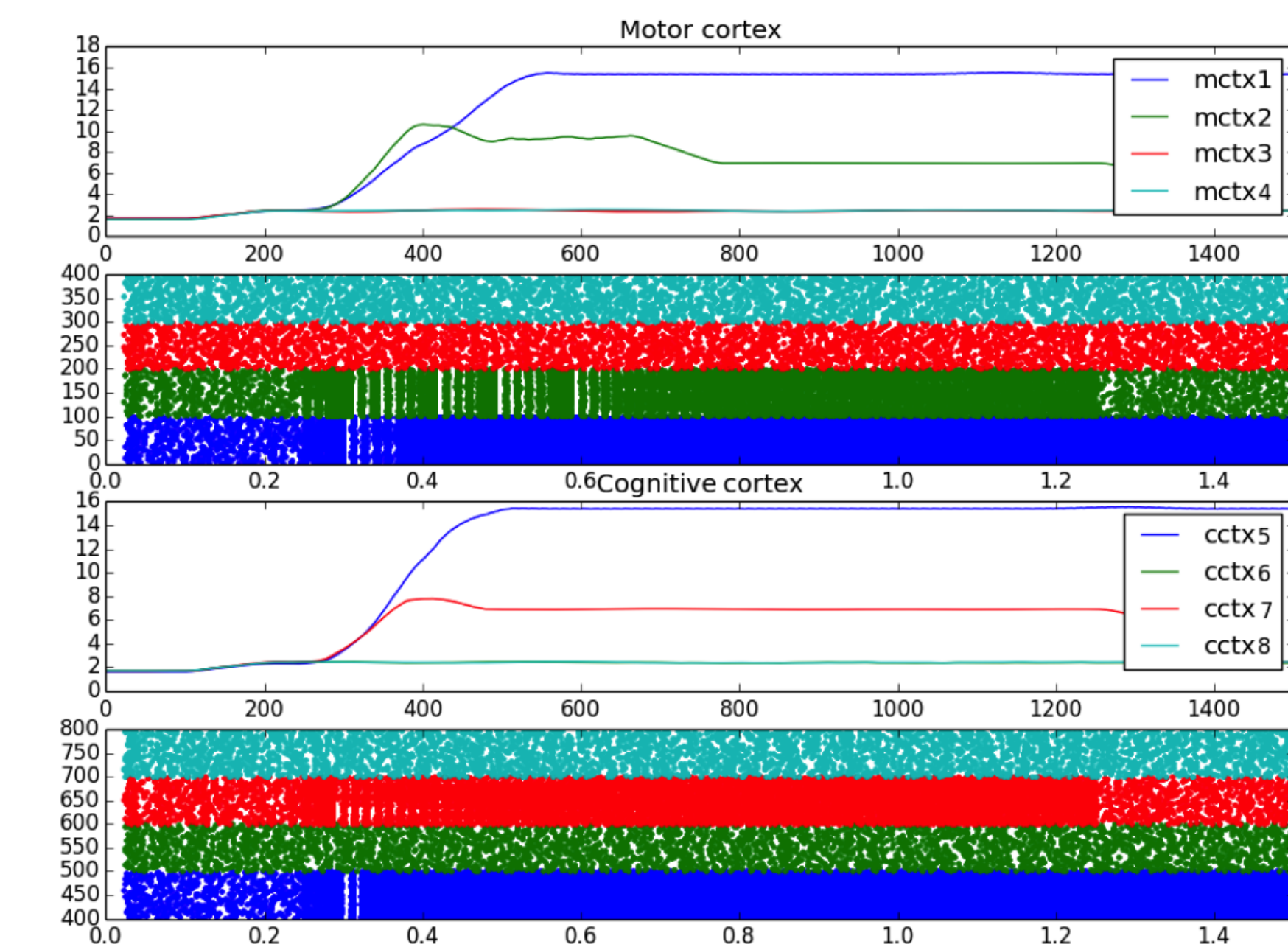

Figure 5. Example of the cortex activity in a naive network

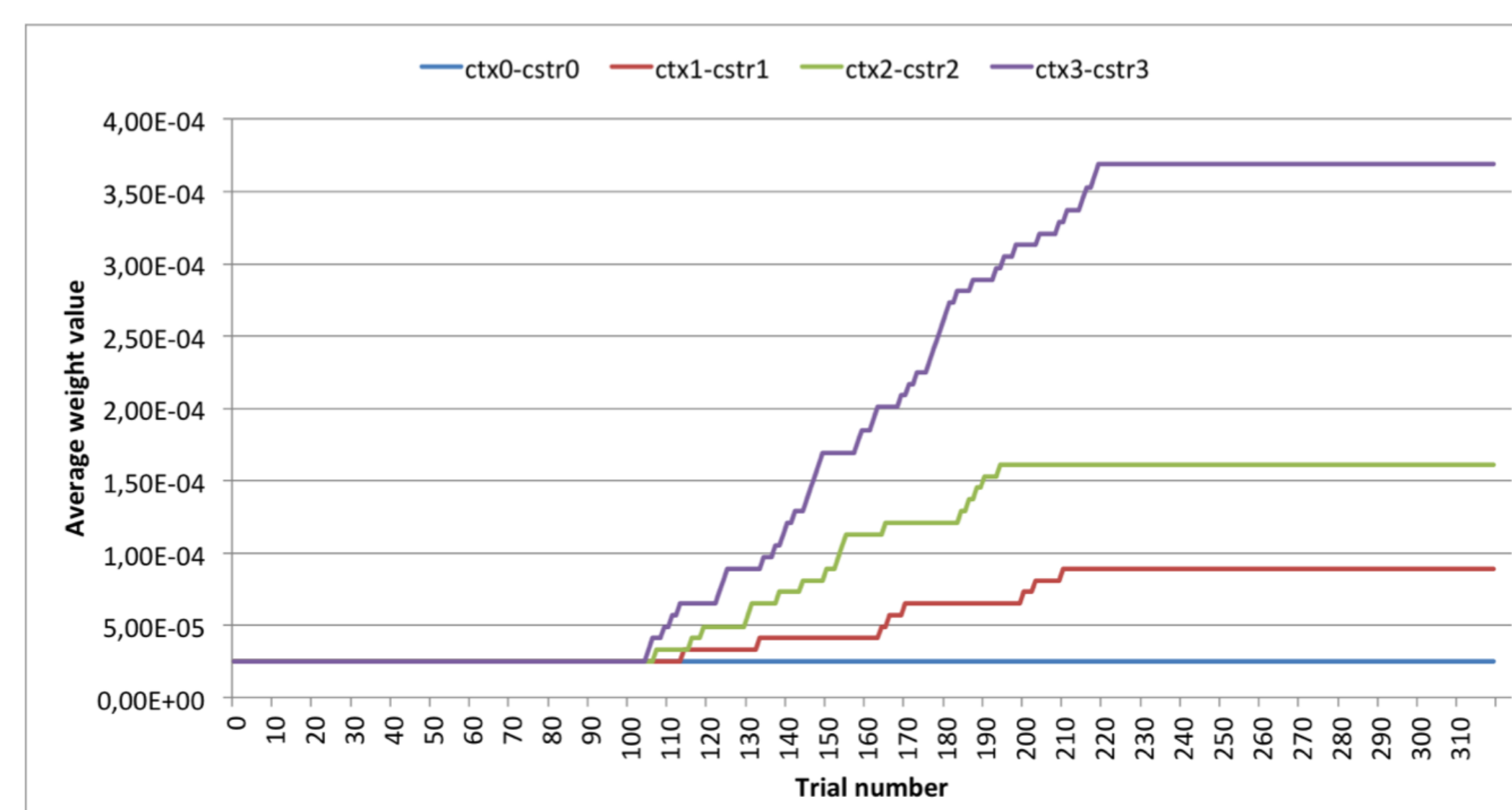

Figure 6. Example of the cortex activity after learning

### Naive network

Ability of spontaneous action selection (defined here by a sufficient difference in the activity between two regions of the motor cortex).

→ Exploration phase ⇔ Target selection of the primate.

### Trained network

Ability to preferentially select the optimum target (highest reward probability).

→ Exploitation phase ⇔ Successful learning from the primate.

### Before/after learning

Better percentage of success (choosing the optimum target, p-value<5%) after learning than before.

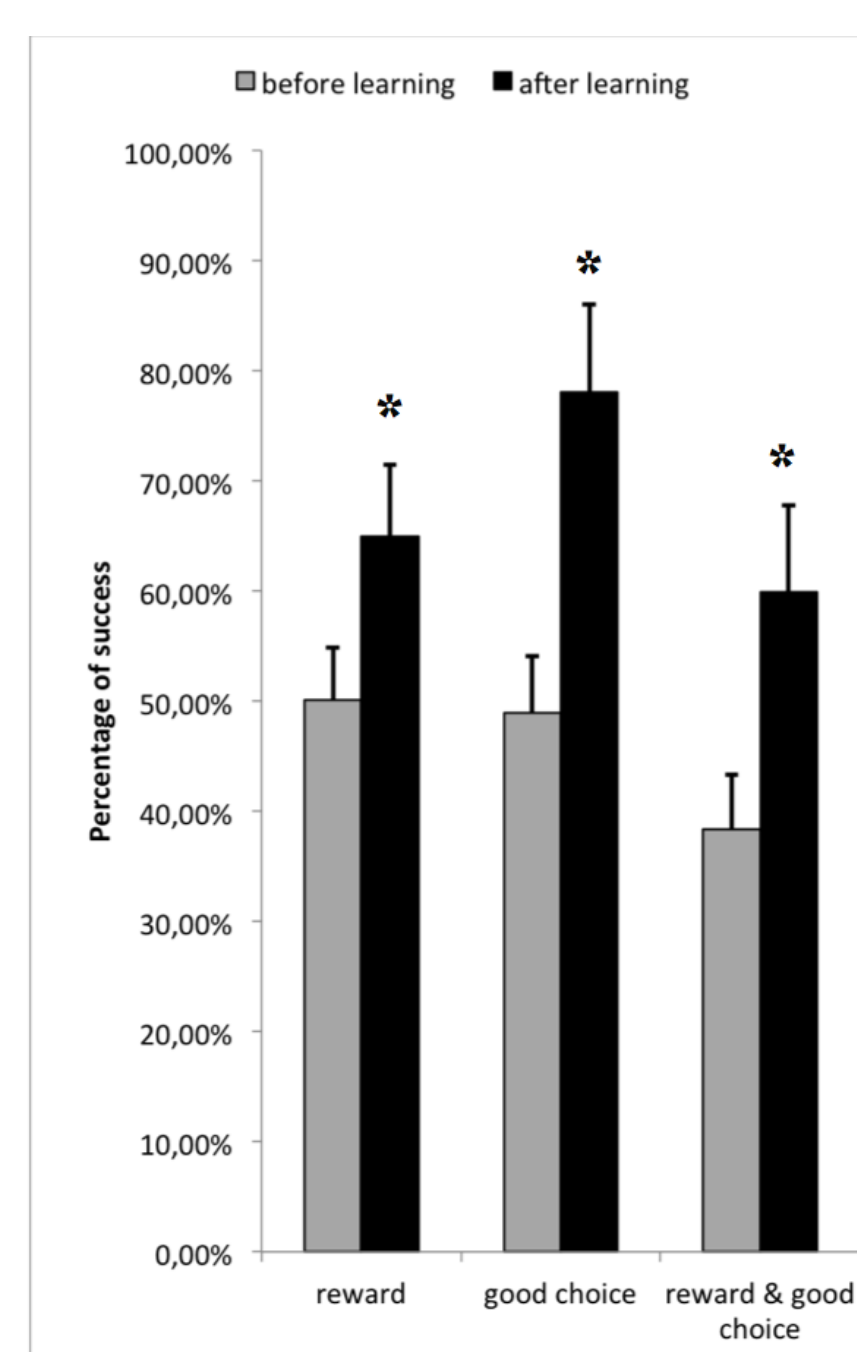

Figure 7. Successful trials before/after learning

## BEHAVIORAL TASK

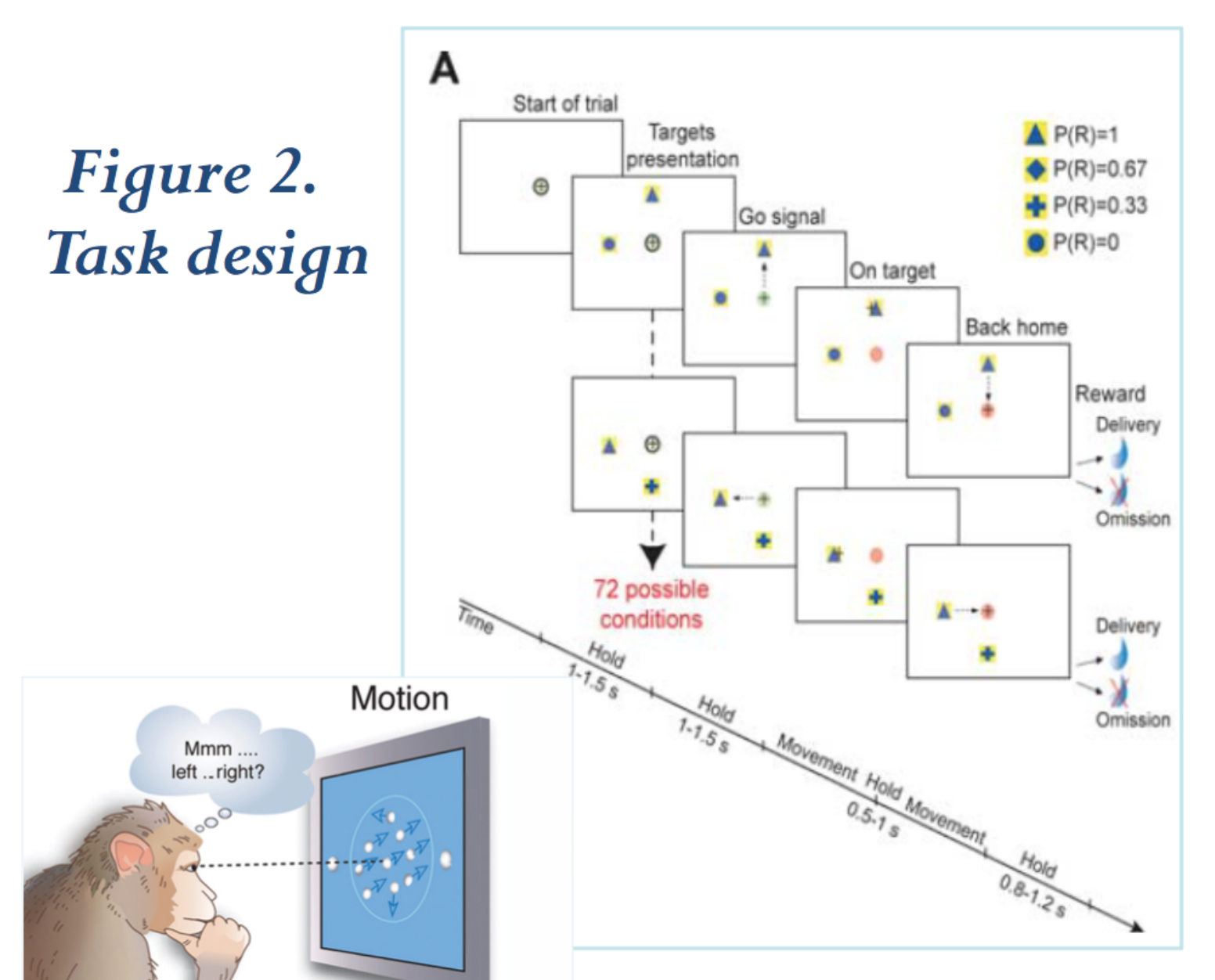

Figure 2. Task design

4 target shapes ⇔ 4 different reward probabilities. At each trial[2]:  
- random presentation of 2 targets, at random positions  
- choice made by the model  
- reward given or not according to the reward probability (probabilistic learning task)  
→ The model has to learn to choose the optimum target on each trial.

## IMPLEMENTATION

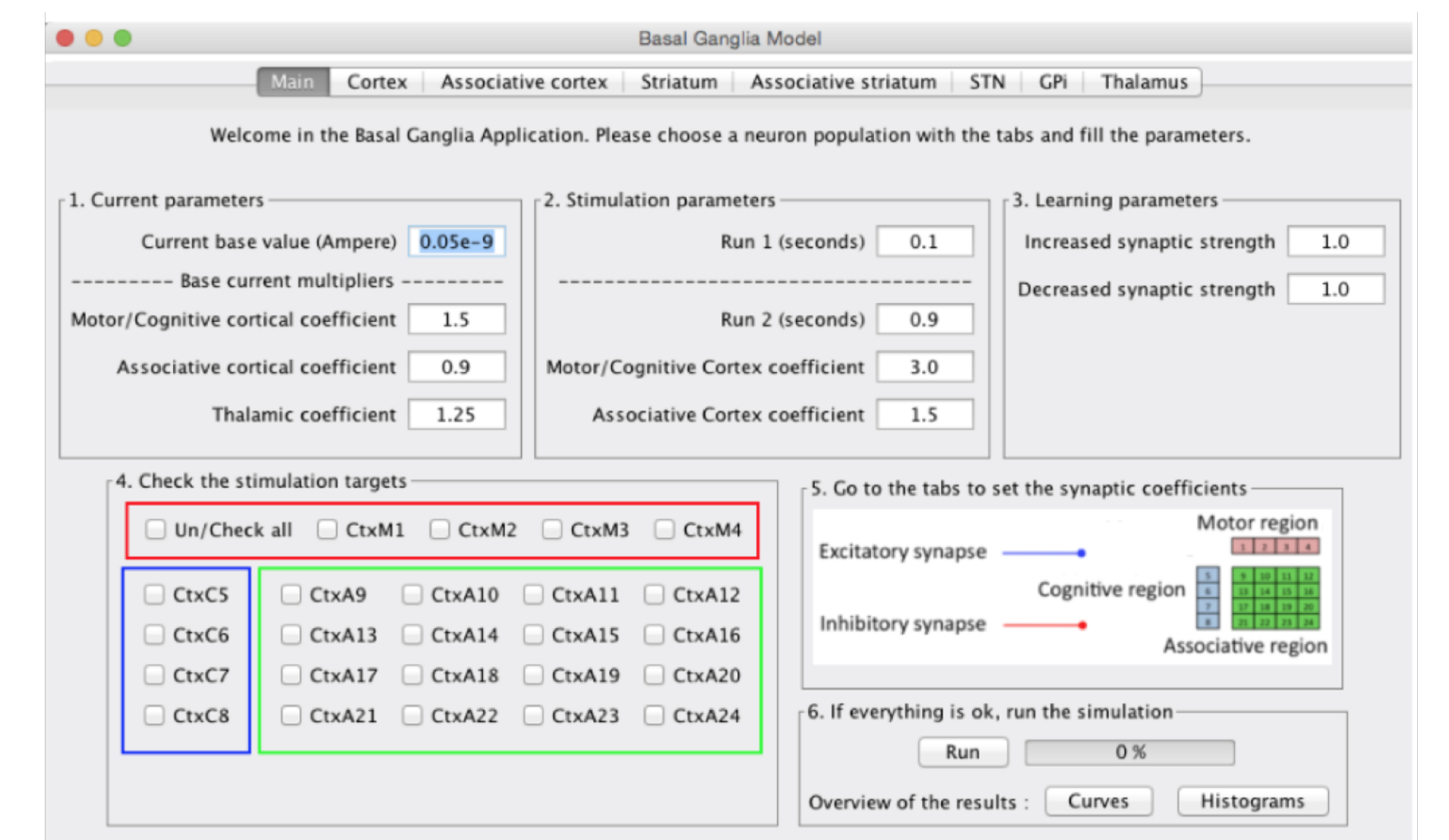
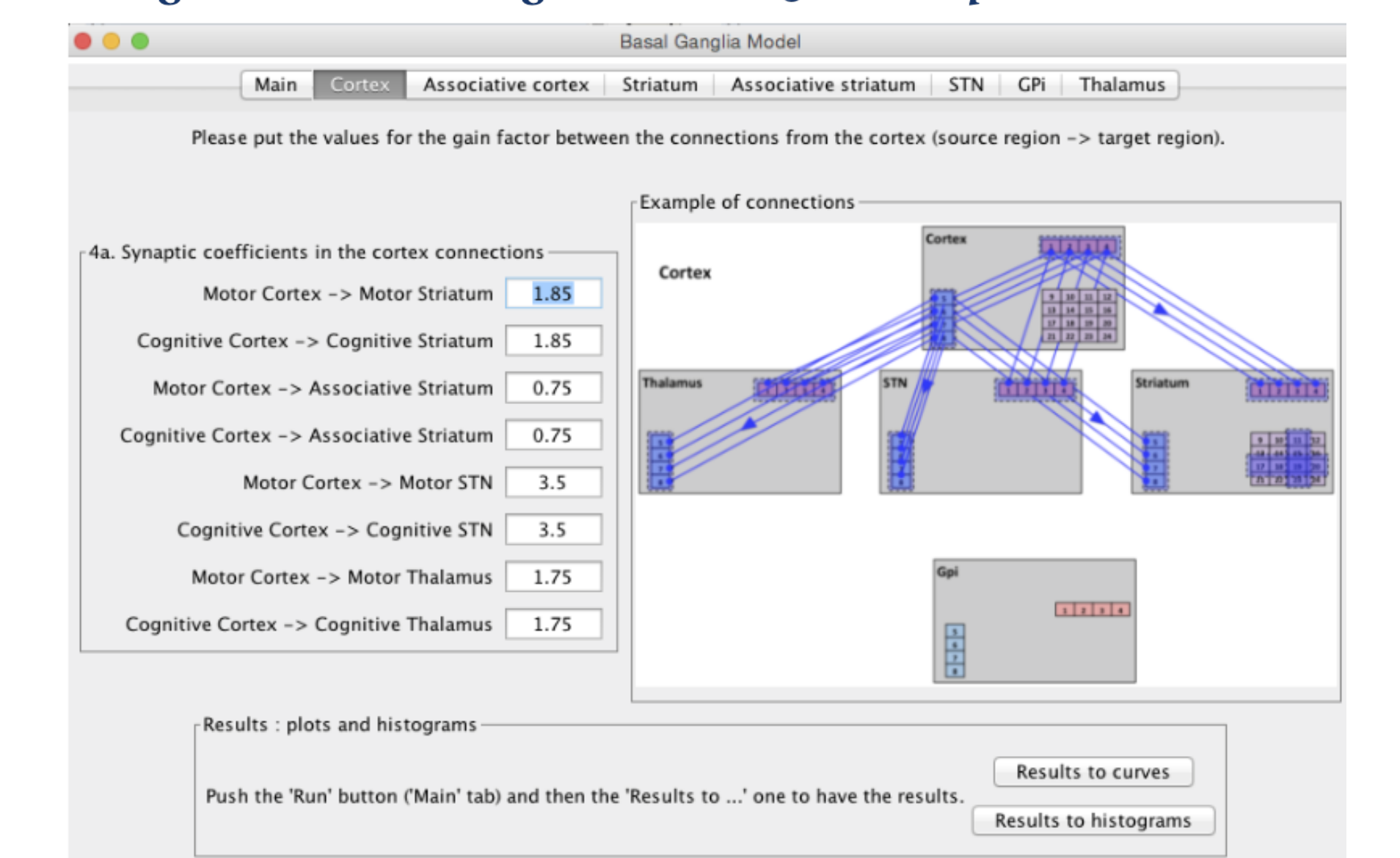

Figure 3. Modeling tool with Java implementation



## DISCUSSION

The neural network implementation of a BG stochastic model is developed, embedded in a sensory-motor closed-loop environment and applied to an action-selection task. Once finalized, this neuron level description model allows for a better understanding of the information flows dynamics in the BG and for an investigation of the physiopathological models including synapses, cells and neuromodulators properties.

To achieve this study, an accurate implementation of a dopamine modulated LTP mechanism will be done to reproduce a complete learning. To validate the model, lesional tests and changes in the conditions of the task are planned.

## REFERENCES

- [1] M. Guthrie et al. Interaction between cognitive and motor cortico-basal ganglia loops during decision making: a computational study, 2013 *J. NeuroPhysiology*
- [2] B. Pasquereau et al. Shaping of Motor Responses by Incentive Values through the Basal Ganglia, 2007 *J. Neuroscience*

## INSTITUTES

- <sup>1</sup> Institut des Maladies Neurodégénératives, CNRS UMR 5293, Bordeaux, France
- <sup>2</sup> Équipe Mnémosyne INRIA, Talence, France
- <sup>3</sup> Université de Bordeaux, Bordeaux, France
- <sup>4</sup> Zoology Department, Faculty of Science, Alexandria University, Alexandria, Egypt

## CONTACT

andre.garenne@u-bordeaux.fr  
charlotte.herice@u-bordeaux.fr