



HAL
open science

A new milestone: the first 7-8 places 2000 meters logarithmic slide cylinder

Denis Roegel

► **To cite this version:**

Denis Roegel. A new milestone: the first 7-8 places 2000 meters logarithmic slide cylinder. [Research Report] LORIA - Université de Lorraine. 2015. hal-01198444

HAL Id: hal-01198444

<https://inria.hal.science/hal-01198444>

Submitted on 15 Sep 2015

HAL is a multi-disciplinary open access archive for the deposit and dissemination of scientific research documents, whether they are published or not. The documents may come from teaching and research institutions in France or abroad, or from public or private research centers.

L'archive ouverte pluridisciplinaire **HAL**, est destinée au dépôt et à la diffusion de documents scientifiques de niveau recherche, publiés ou non, émanant des établissements d'enseignement et de recherche français ou étrangers, des laboratoires publics ou privés.

A new milestone: the first 7-8 places 2000 meters logarithmic slide cylinder

Denis Roegel
LORIA*

25 March 2015
(last version: 8 August 2015)

1 Logarithms

Logarithms were invented by John Napier and the first table of logarithms was published by him in 1614 [41]. The correspondence between multiplication and addition was known before Napier, but Napier was the first to define an abstract logarithm function, and he managed to construct a table of logarithms, with a clear view of the accuracy of the values of his table. More precisely, whenever Napier computed a logarithm, he obtained a certain value which he knew was only an approximation of the value of the abstract function he had defined, but he was able to find a majorant for the error.

Jost Bürgi, a clockmaker who made wonderful mechanisms well ahead of his time, is also often credited as an independent discoverer of logarithms, including by some well-known historians such as Cajori, but in our opinion this is really a misunderstanding. First, many of those who wrote about Bürgi haven't read Bürgi's introduction (which was only published in the 19th century), and failed to see the absence of a notion of function, or of the measure of an interpolation's error, which are two essential features of the invention. They also often assumed that the existence of a table of logarithms (or antilogarithms) implied the discovery of the logarithmic function, when in fact it is possible to construct such a table without a

*Denis Roegel, LORIA, BP 239, 54506 Vandœuvre-lès-Nancy cedex, France, roegel@loria.fr

full understanding of the properties of the function. In fact, many authors never defined what they understood by “discovering logarithms” and did not distinguish the discovery of logarithms and the making of a table of logarithm-like functions. But Bürgi neither had the notion of an abstract function, nor did he evaluate the accuracy of an interpolation, something that Napier did. This is exactly why we consider that Bürgi is not an independent discoverer of logarithms, and that he could not be considered so even if he had published his table, say, in 1610.

Of course, our position has seemed heretic to some, and we were perhaps even considered a revisionist,¹ but we trust that anybody who studies carefully both Napier’s and Bürgi’s works, as well as all the secondary literature (see a number of references in [56, 55]), will without any doubt concur with us.² But alas, those who write on Napier often don’t know about Bürgi, and those who write on Bürgi often don’t know about Napier!³

2 Linear slide rules

A very important consequence of Napier’s invention was the development of the slide rule.⁴ But first came Gunter’s scale. Figure 1 shows a logarithmic scale, which was one of the scales found on the scale named after Edmund Gunter (1581–1626) who invented it in 1620. Multiplications or divisions could be done with this rule using a pair of dividers. Around 1622, William Oughtred (1574–1660) had the idea of using two logarithmic scales and putting them side by side (figure 2), which made it possible to dispense with the dividers. Oughtred’s initial design used circular scales [46, 73], and pairs of straight scales were only introduced later.

It is easy to see how these scales are used and why they work. In

¹Our position gave rise to more misunderstandings, when it was for instance suggested that we were not allowed to attend the conference for the celebration of the 400th anniversary of Napier’s logarithms (*Zürich’s Tages-Anzeiger*, 25 March 2014, page 34). In fact, contrary to what the article suggests, we were invited, but decided not to attend that conference, for reasons totally unrelated to Bürgi!

²Obviously, one problem is that some authors only use secondary sources that they trust too much.

³Interestingly, there is a whole world for which neither Napier, nor Bürgi invented logarithms. For that world, it was Ibn Hamza who should be credited, having published a treatise on progressions in 1591, and therefore surely had thought of his subject many years before [2].

⁴Parts of this introduction are borrowed from our earlier analysis of Napier’s logarithms [56].

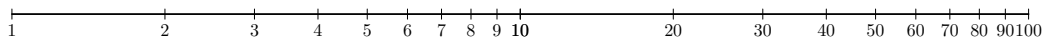

Figure 1: A logarithmic scale from 1 to 100.

figure 1, the scale goes from 1 to 100, and the positions of the numbers are proportional to their logarithm. In other words, the distance between n and 1 is proportional to $\log(n)$. The distance between 1 and 10 is the same as between 10 and 100, because their logarithms are equidifferent. A given divider opening corresponds to a given ratio. Multiplying by 2 corresponds to the distance between 1 and 2, which is also the distance between 2 and 4, between 4 and 8, between 10 and 20, etc. A pair of divider can therefore easily be used to perform multiplications or divisions.

In figure 2, two such scales are put in parallel and the 1 of the first rule is put above some position of the second scale, here $a = 2.5$. Since a given ratio corresponds to the same linear distance on both scales, the value c facing a certain value b of the first scale, for instance 6, is such that $\frac{c}{a} = \frac{b}{1}$, and therefore $c = ab$. The same arrangement can be used for divisions, and dividers are no longer needed.

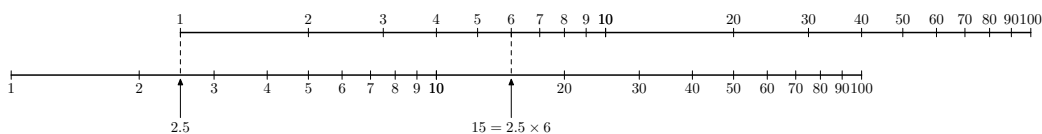

Figure 2: Two logarithmic scales showing the computation of $2.5 \times 6 = 15$.

On the history of the slide rule, we refer the reader to Cajori's articles and books [13, 14, 15, 16]⁵ or Stoll's popular account in the *Scientific American* [65]. On the construction of the logarithmic lines on such a scale, see also Robertson [51] and Nicholson [42]. A good source for more recent information on the history of slide rules is the *Journal of the Oughtred Society*, in particularly their guide about slide rules [19].

The longest linear slide rule ever built seems to be the "Texas Magnum" (2001) with a length of 350 feet 6.6 inches (about 107 meters).⁶ A previous record of 323 feet 9.5 inches (about 99 meters) was completed in 1979 at the University of Illinois and was validated by the Guinness book of world records.⁷

⁵In his 1909 book, Cajori first attributes the invention of the slide rule to Wingate, but then corrects himself in an addenda.

⁶Ft. Worth Star-Telegram, March 1, 2001 (www.slideruleguy.com/fwst.htm).

⁷www.slideruleguy.com/recordhistory.htm

3 Circular slide rules

In 1632, soon after the introduction of the slide rule, William Oughtred published a circular version of a slide rule (figure 3a) [46, 73]. In this circle, we can in particular notice a circular logarithmic scale going from 1 to 10 counterclockwise (fourth division from the outside). Figure 3b shows this scale alone.

A major advantage of a circular slide rule is that operations can be chained, since we have in fact a kind of infinite slide rule: 1 resumes whenever we reach 10, something that can't be done on an ordinary slide rule. There are never any overflows on such a rule!

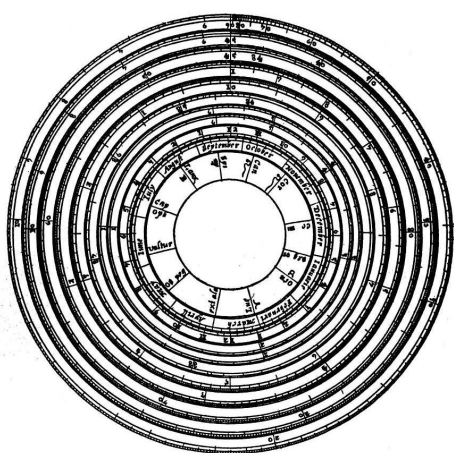

(a) Oughtred's circle of proportion

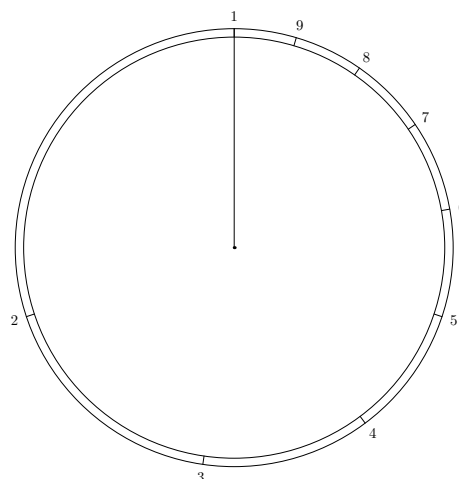

(b) A circular logarithmic scale from 1 to 10

Figure 3: Circles of proportions

4 Cylindrical slide rules

The second half of the 19th century saw the invention of several cylindrical slide rules. These inventions were all meant to provide longer and therefore more accurate scales, but in such a way that they could still be managed. Leibniz may have been the first to suggest the construction of a cylindrical slide rule [57], but we do not know if it was ever built. One of the earliest cylindrical slide rule actually built was that constructed by Mannheim in 1851.⁸ But the first important cylindrical slide rule was Fuller's.

4.1 Fuller's cylindrical slide rule

George Fuller (1829–1907) was a British civil engineer and professor of engineering at Queen's College, Belfast.⁹ In 1878 and 1879, Fuller obtained British and US patents for a cylindrical slide rule which he called a "calculator" [24, 23, 68, 35]. Fuller merely took a scale of about 13 m and wound it around a cylinder. This cylinder was hollow and could move up or down or around a cylindrical axis. The US patent model is still extant and kept at the Smithsonian's National Museum of American History. Fuller's cylindrical became very successful and was manufactured until 1975.

The theory behind Fuller's slide rule is the following. On a linear slide rule, two pairs of values $(x_1, x'_1), (x_2, x'_2)$ at equal distances are in a constant ratio. This remains true on Fuller's slide rule (figure 4), but the distances are no longer to be measured in a plane. Nevertheless, a constant cylindrical distance can be implemented by using two mobile cursors, and that is exactly what Fuller did. The two indices are set on a given ratio, then the central cylinder is moved until one of the indices shows the value to multiply by some ratio. The other index then shows the result. The accuracy is to 4 or 5 places.

There are other cylindrical rules following the same principles, in particular the one invented by Aleksandr Shchukarev (1864–1936) in 1909 [36]. Some Fuller-type slide rules were also manufactured by other constructors, for instance Otis King (British patent 183723 from 1921 and later ones) and Browne in Australia [59], with various adaptations. For instance, King's slide rule is actually made of two helical scales, instead of only one on Fuller's rule. This makes it possible to have a constant connection

⁸A picture of Mannheim's rule appears in a 1990 exhibition catalogue [40].

⁹Fuller's biographical information was obtained from the National Museum of American History.

between the two scales, instead of the two cursors of Fuller's slide rule, merely by using a sliding cylinder.

G. FULLER,
Calculator.

No. 219,246.

Patented Sept. 2, 1879.

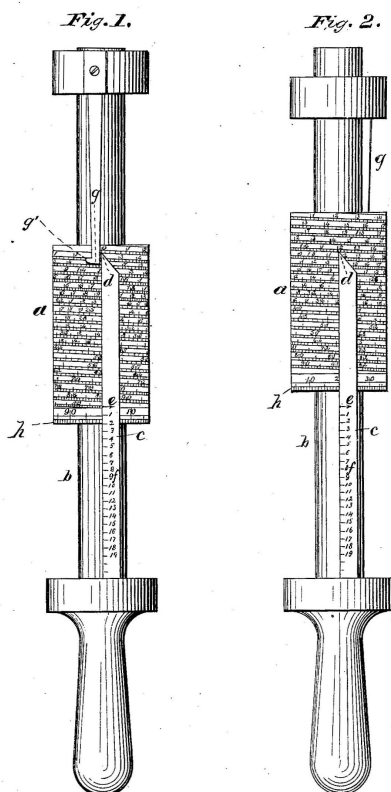

Witnesses:
J. C. Brecht,
Wm. Beale Beale

Inventor
George Fuller,
By *James S. Norris*
Attorney.

Figure 4: Figure from Fuller's patent (1879).



Figure 5: An excerpt of an Otis King slide rule. (Wikipedia, photo by Richard Lyon)

4.2 Thacher's cylindrical slide rule

Another way to obtain a compact slide rule was devised by Edwin Thacher (1839–1920) [66, 67, 68]. Thacher was an American civil engineer. He first worked on railroads, then on the construction of bridges until 1912. His archives, including a file on his slide rule, are kept at the Rensselaer Polytechnic Institute.

Thacher divided a long slide rule into a number of overlapping segments, and all these segments were written on the generating lines of a cylinder. This cylinder could move within another cylindrical grid made of wedged rules representing the slide (figures 6, 7, and 8).

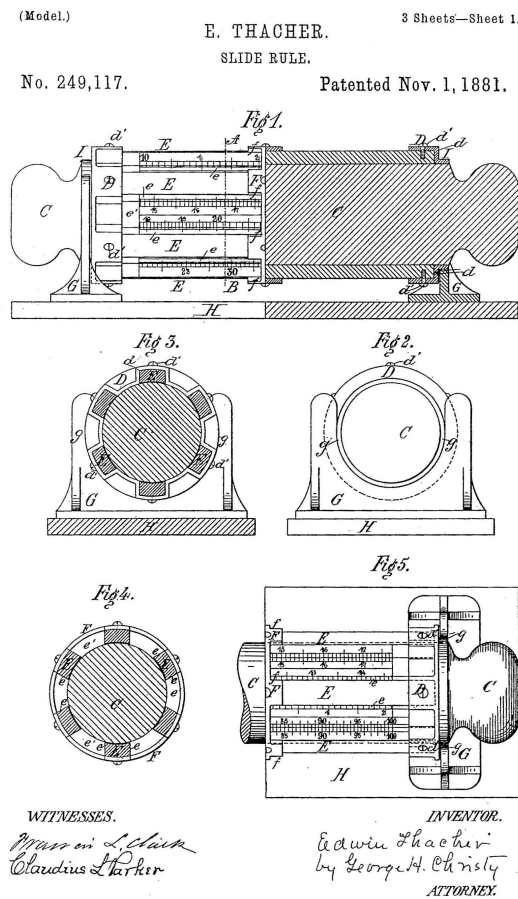

Figure 6: Figure from Thacher's patent (1/3) (1881).

(Model.)

3 Sheets—Sheet 2.

E. THACHER.
SLIDE RULE.

No. 249,117.

Patented Nov. 1, 1881.

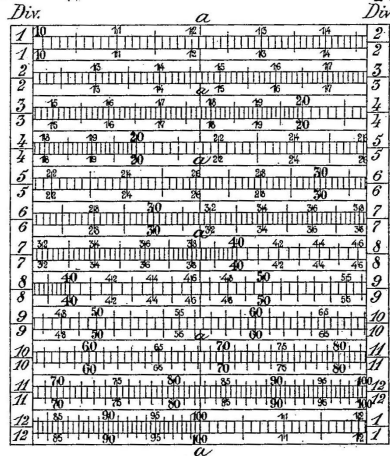

Fig. 6.

Fig. 8.

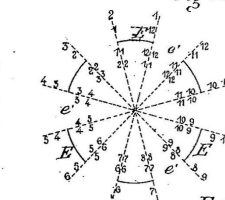

Fig. 9.

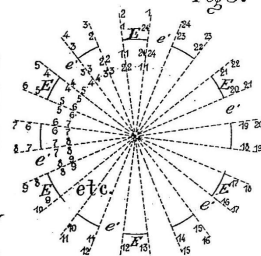

Fig. 10.

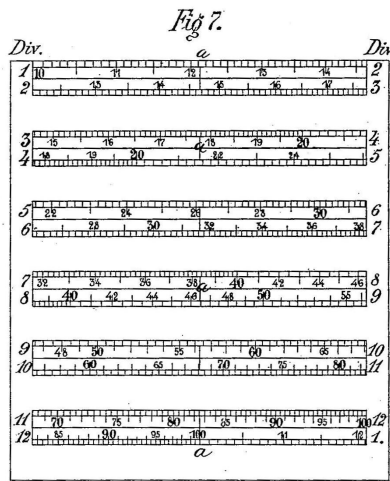
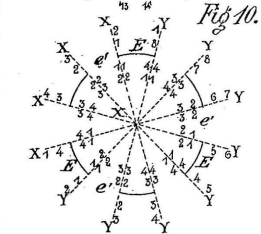

Fig. 7.

WITNESSES.

William S. Phelps
Claudius A. Porter

INVENTOR.

Edwin Thacher
by *George H. Christy*
ATTORNEY.

Figure 7: Figure from Thacher's patent (2/3) (1881).

(Model.)

E. THACHER.

3 Sheets—Sheet 3.

SLIDE RULE.

No. 249,117.

Patented Nov. 1, 1881.

Fig 11.
ca

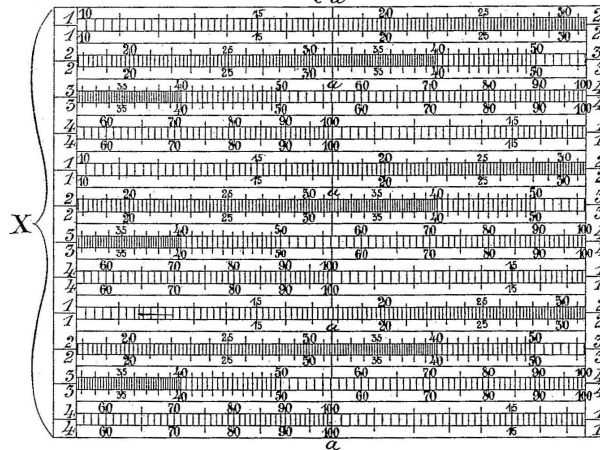
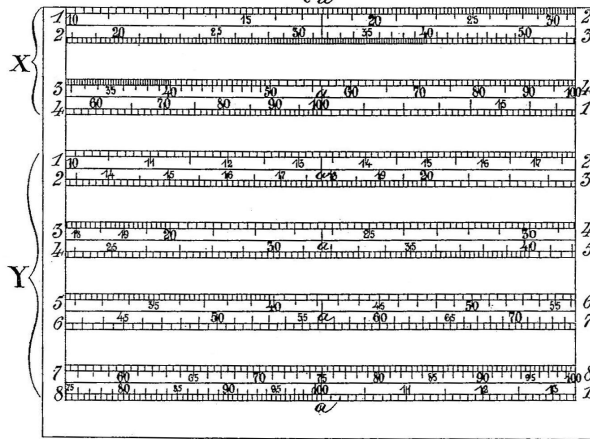

Fig 12.
ca



WITNESSES.

*L. Blank
E. Parker*

INVENTOR.

*Edwin Thacher
by George H. Chasity*

ATTORNEY.

Figure 8: Figure from Thacher's patent (3/3) (1881).

4.3 Billeter's cylindrical slide rule (1891)

Yet another way was that of the Swiss Julius Billeter (1828–1914). Billeter first patented a calculating tablet (*Rechentafel*) in 1887 [4]. This tablet (figure 9) was very similar to Thacher's rule, but it was a flat scale, with a moving grid. The base scale was doubled horizontally, but also vertically, so that the grid (a glass overlay which Billeter called a *transporter*) would always be over the base scale.

In 1891, Billeter went a step further and patented a cylindrical slide rule (*Rechenwalze*)¹⁰ [5, 6]. This was really a cylindrical version of his calculating tablet. The scale was again broken into a number of overlapping lines and placed on a cylinder (figure 10), like Thacher's cylinder. But contrary to Thacher's cylinder, Billeter's cylinder could only rotate, not be translated along the axis. Instead, Billeter devised a moving grid (also called a *transporter*). This grid was itself a cylinder, and it could rotate around the (also moving) cylinder, or be translated. The grid had a full and non overlapping scale, but the cylinder's scale was overlapping so that the grid could be moved right or left of any value. This is necessary because the grid cannot extend beyond the cylinder. But the base scale was not vertically doubled, as there was no longer any need for it. Examples of such logarithmic cylinders are given in figures 12 and 13.

These cylinders are very easy to use. Taking Billeter's own example from his 1893 patent [6], in order to compute 11×11 , one first puts the initial mark (representing 10) of the grid on the mark 11 from the base scale (figure 10). The base scale then gives the products of all numbers from the grid by 11. So, looking up 11 on the grid, one finds 121 on the base scale. The operation is exactly the same as the one that would be done on a normal slide rule, the grid being the equivalent of the slide.

Billeter, and later his sons, continued the production of cylindrical slide rules until 1942 [32]. Julius Billeter's work was continued by his sons Ernst and Max, who made some improvements to these slide rules (figure 11). The Swiss Heinrich Daemen-Schmid (1856–1934) also started constructing such slide rules in 1900 [25] and his company took the name LOGA in 1915 and operated until 1979. Most of the cylindrical slide rules were produced by this company, including one with a 24 m scale, but rules of the same type were also built by the companies National, Tröger, Nestler, and a few others [17]. We should also mention another type of slide rule, not strictly cylindrical, but using film on rolls. With such a technique, scales of up to

¹⁰The German word *Rechenwalze* had a different meaning around 1800, when it was referring to a gardening tool, see *Allgemeine deutsche Garten-Zeitung*, Volume 8, 1830, page 295.

about 66 m were designed by Stibitz in 1947 [63, 10, 64, 75, 72].

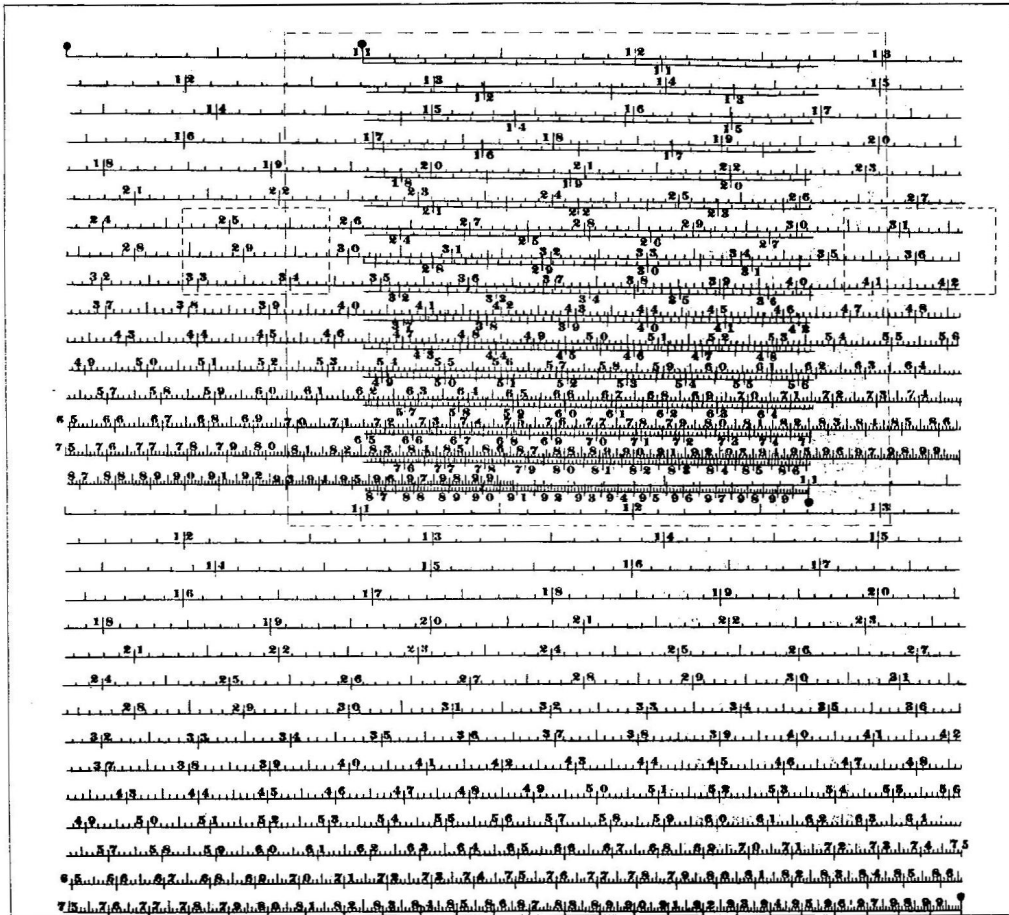

Figure 9: Figure from Billeter's patent on a calculating tablet [4] (1887). The dashed rectangles left and right of the overlay represent leather handles for manipulating the glass overlay.

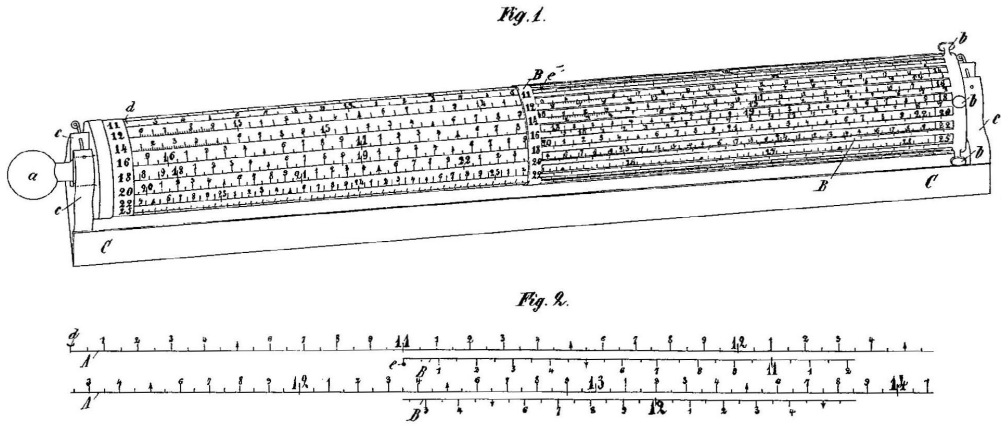

Figure 10: Figure from Billeter's patent on a calculating cylinder [6] (1893).

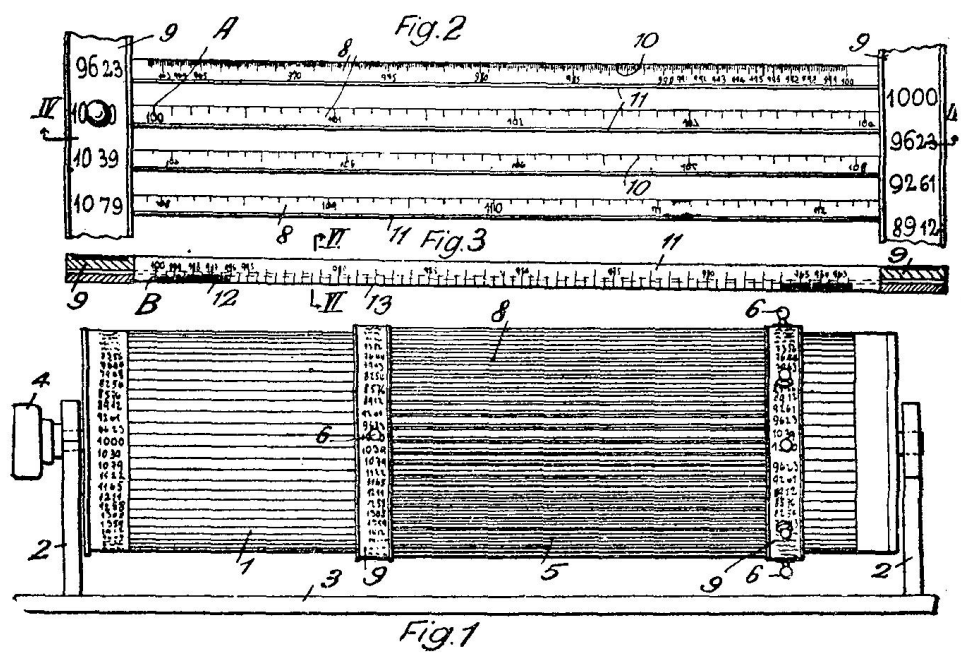

Figure 11: Figure from (Max) Billeter and Bohnhorst's patent on a calculating cylinder [8] (1917).

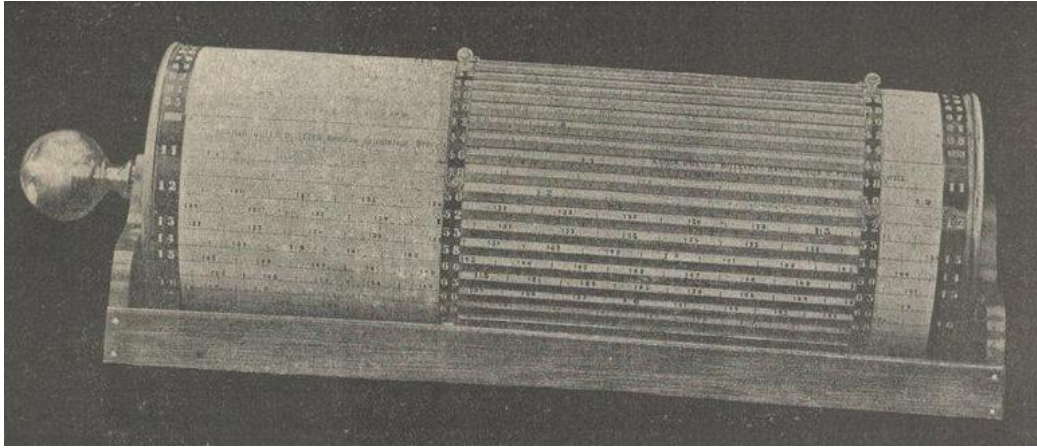

Figure 12: A logarithmic cylinder [58, p. 205].

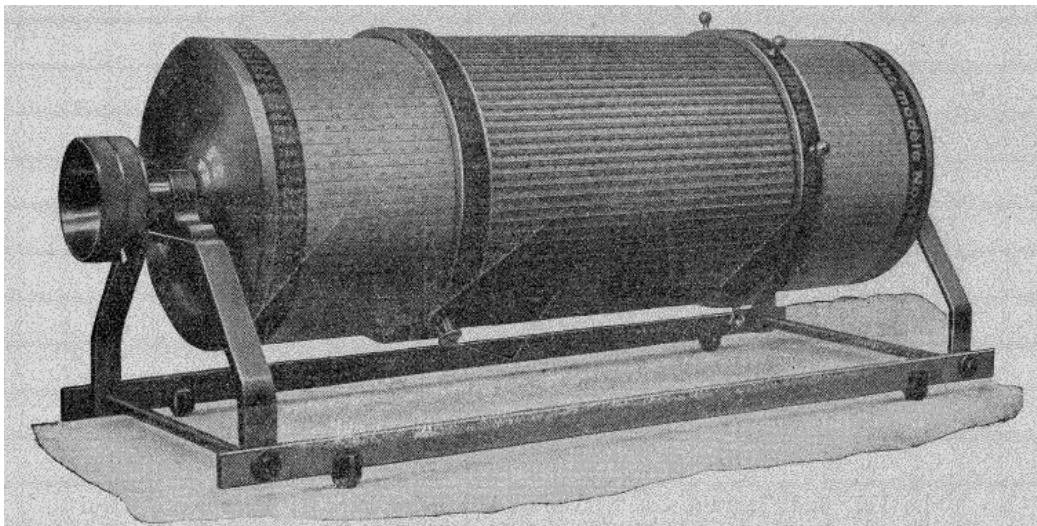

Figure 13: A logarithmic cylinder made by the National company [37, p. 639].

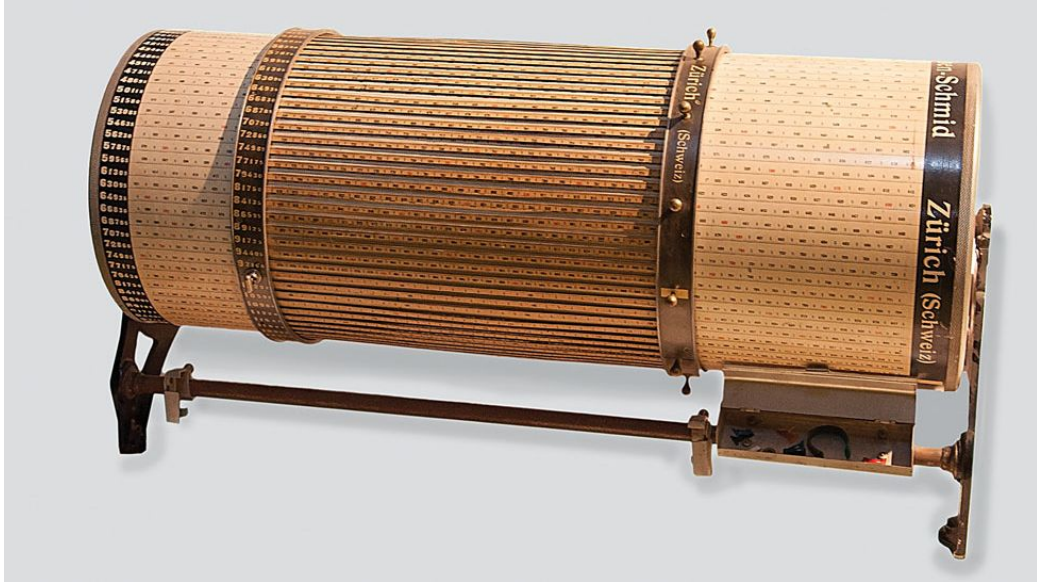

Figure 14: A 24 m LOGA cylindrical slide rule at UBS Basel. (picture provided by Céline Rader, UBS, reproduced with permission)



Figure 15: Detail of a 15 m LOGA cylindrical slide rule, with the grid wrongly mounted.
 (<http://www.bonhams.com/auctions/13633/lot/249>)

4.4 Podtiagin's cylindrical slide rules (1926–1928)

Mikhail Podtiagin (Подтягина) (1889–1969?) was born on April 17, 1889 in Kursk, and graduated from the University of Heidelberg in 1911. His dissertation was on the physical and mathematical analysis of the wind speed. In 1924, he published a book on the economy of the USSR. He became professor in 1926. In 1927, he was residing in the United States.

At the end of the 1920s, Podtiagin invented another cylindrical slide rule [49, 47, 48, 36] (figures 16, 17, 18). His slide rule made use of transparent celluloid tubes. The base scale was made of 20 logarithmic lines and the scales were duplicated like on Billeter's scheme.

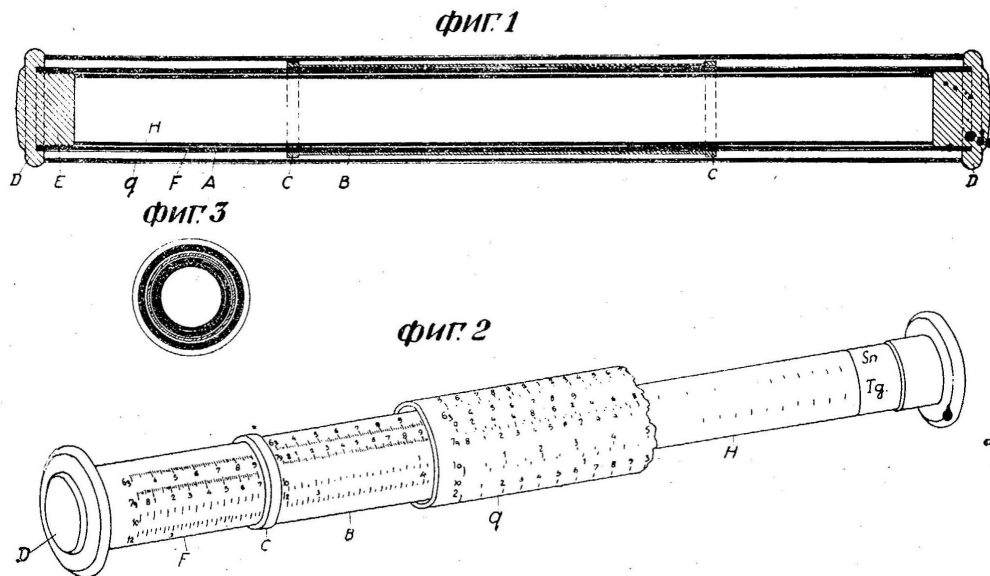

Figure 16: Figure from Podtiagin's soviet patent [49] (1926).

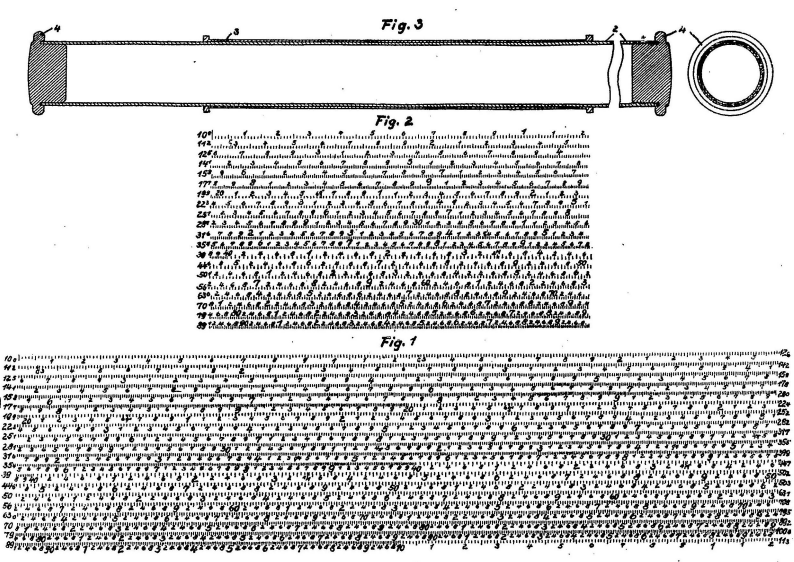

Figure 17: Figure from Podtiaguin's French patent [47] (1927).

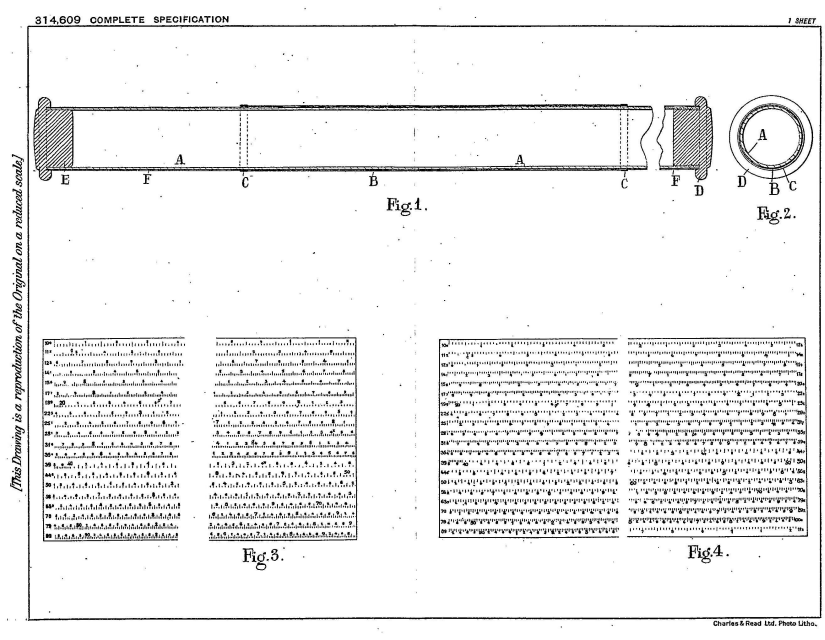

Figure 18: Figure from Podtiaguin's British patent [48] (1928).

5 The construction of the scales

The best way to understand the scales of cylindrical slide rules is to compute new scales. This is what we have done for a number of different configurations. For instance, figures 19 and 20 show the base scale and overlay (grid) scale of a hypothetical 250 cm cylindrical slide rule of Billeter's type.

5.1 Measuring the scales

The slide rule collector may sometimes wish to measure the length of a cylindrical slide rule of Billeter's type. Joss gave a somewhat cumbersome method [31], but the simplest way is to measure the longest line (making sure of avoiding overlaps) and to multiply it by half the number of lines. This calculation does not require the computation of a logarithm! However, if you do not want to count the number of lines, you can compute it easily, but this time using logarithms!

In the case of figure 19, for instance, the full line is 50 cm long, and this can merely be multiplied by half the number of lines. Now, since we show only an excerpt, we don't have the full length, and we also need to compute the number of lines. We can see that the ratio from one line to the next is about $12.59/10$, hence the number of lines is about $1/\log(12.59/10) = 9.997\dots$. In fact, all the lines are shown, and there are 10 of them. So multiplying 50 cm by 5 gives 250 cm.

In order to estimate the full length of a line, we can proceed similarly, and find the ratio corresponding to a given length. For instance, if we take the entire 10 cm excerpt, we find that the corresponding ratio is about 1.0965, so that the a full line is $\log(10^{2/10})/\log(1.0965) = 4.998\dots$, hence 5, from which we find again the full width of 250 cm. So, contrary to what one author once wrote, measuring the scales is not difficult at all, and really is a child's play.

5.2 Constructing the scales

The (pre-computer) construction of the scales of a Billeter cylindrical slide rule is actually also very easy and can be done using a sufficiently accurate table of logarithms. First, we must observe that each cylinder is made of a number of lines, and that each line starts with a certain value. It is straightforward to compute this value: if there are N lines, the ratio from one line to the next is $10^{1/N}$. For instance, on the 24 m scales which have

80 lines, the ratio from one line to the next is $10^{1/80} = 1.029\dots$. The list of all 80 initial values can easily be computed. Now, every value x on the line starting with s is positioned at a distance which is proportional to $\log(x/s) = \log x - \log s$, and this difference is directly extracted from a table of logarithms.

In order to avoid multiplying the differences of logarithms by a constant factor, it is much simpler to build a (normal) rule using this new scale. For instance, since one line of the 24 m scale is 60 cm long and corresponds to the ratio $(10^{1/80})^2 = 1.059\dots$, $1/40$ corresponds to 60 cm. One can then build a 60 cm rule whose values range between 0 and $1/40$, and it is then very easy (albeit time consuming) to position all the ticks on some master grid. It is also possible to place the ticks on a larger grid, and reduce it photographically to the desired size. This mode of producing scales was mentioned by Podtiagin [48].

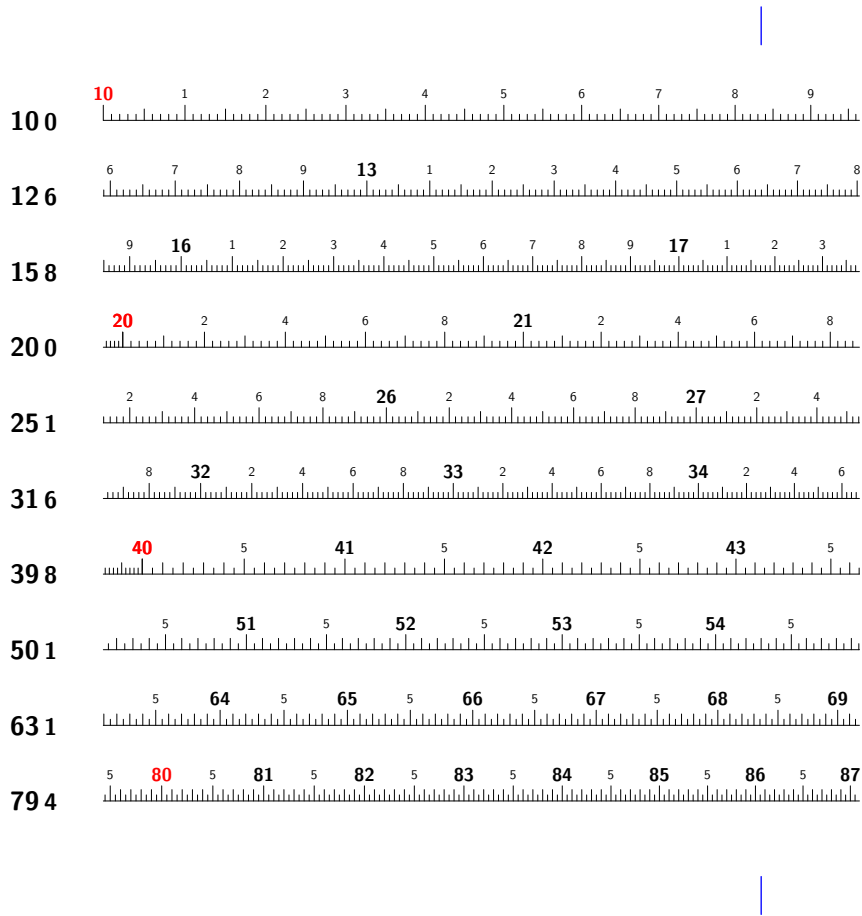

Figure 19: An excerpt of the base scale of a 250 cm cylindrical slide rule. The blue ticks are for alignment purposes with the other tiles.

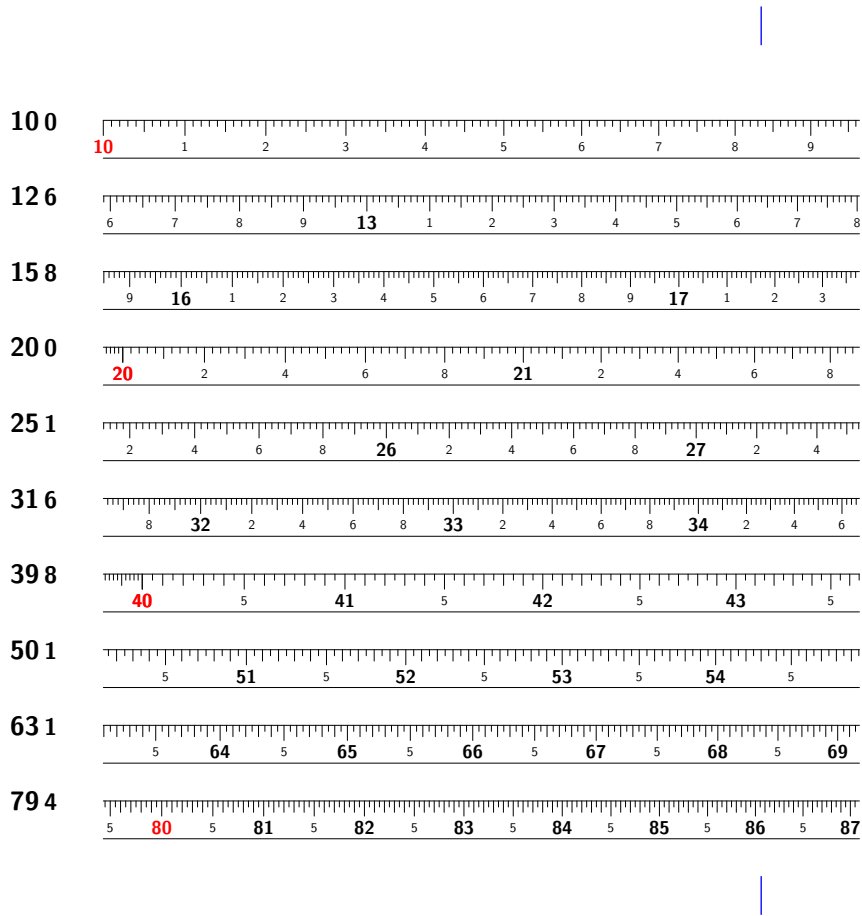

Figure 20: An excerpt of the overlay scale of a 250 cm cylindrical slide rule. The blue ticks are for alignment purposes with the other tiles.

6 A new milestone

Up to now, the longest cylindrical slide rules of Billeter's type, to the author's knowledge, are the 24 meters ones built by the LOGA company from Zürich [62]. In fact, 24 meters is not much for a cylindrical slide rule, since the cylinders had only a length of about 60 cm. Such rules are also not difficult to make. What has prevented the existence of larger slide rules is that they then become difficult to use. There is nothing particularly impressive in a 24 meters cylindrical slide rule, and we feel that there has been way too much hype around these almost mundane instruments.

As an appendix to this article, we provide blueprints for two simple cylindrical slide rules, in particular for the 24 m LOGA cylinders.¹¹ Note that our blueprints are approximations of the historical cylinders, but they are nevertheless functional. There is not only one way to construct these cylinders. We have in particular only used one scale, whereas some cylindrical slide rules have several scales on the same cylinder.

For each reconstruction, we provide two files, one for the base scale (on the inner cylinder), and one for the grid scale (overlay). Each part is in fact a tiling. For the 24 m cylinder, the base scale spans 16 pages, whereas the grid only spans 8 pages. Each set gives rows first, and the pages go from left to right. What one should do is to print these two sets onside, trim the pages (there is a 1cm overlap in the scales), and stick them together. In order to ease these operations, the start value of each line is repeated on each page, but it should only be kept on the first page of a row. There are also blue marks to help for the alignment and these marks should also vanish after the vertical trimming. The overlay should moreover be cut open and glued on some adequate rigid grid. The base scale should be glued on a cylinder. We have assumed a distance of 1 cm between lines, and this should therefore fit a cylinder of diameter $80 \text{ cm}/\pi \approx 25.46 \text{ cm}$. These are approximately the real dimensions of the 24 m LOGA cylinders [62].

Our main object is a 2000 meters slide rule. We have chosen this length because it is metric, because it goes beyond the mile (whatever its definition), and because it provides for an accuracy of 7-8 places. This cylindrical rule then is equivalent to standard tables of logarithms to 7 (for instance Sang's table [60]) or to 8 places (for instance the tables published in

¹¹After we started our work, we found out that Wayne Harrison and Bob Wolfson had already been working on the reconstruction of cylindrical slide rules. Harrison made scales and Wolfson constructed the actual cylinders. But as far as we know, the greatest cylinder that they reconstructed is a 15 m one. A draft for the scale of a 11 m cylinder made by them is available on Harrison's site (<https://sites.google.com/site/nwayneharrison/home/the-loga-project>).

1891 [61, 21], or more recent ones).

This rule makes it possible to compute multiplications or divisions to 7-8 places of accuracy. However, it does not give the logarithms to 7-8 places, since there is no linear scale to read them.

Like for the 24 m rule, we provide a tiling of the cylinder (1160 pages), as well as for the grid (600 pages). We have chosen a cylinder with 1000 lines, each spaced by 6 mm. Its diameter is therefore 191 cm. The cylinder's length is 4 meters. Of course, anyone wishing to print these files can reduce or enlarge them, and it will still work, provided that all 1760 pages are processed in the same way. It is also possible to construct a flat grid, with the same tiles, but in that case we suggest to duplicate the base scale, as Billeter did in his first patent.

We would love to hear from anyone who wants to build such a cylindrical slide rule, or even a smaller one,¹² and we are willing to tailor our dimensions for any interesting project.

Of course, such a monster cylinder is less practical than the simple 7- or 8-place tables, but perhaps it is more fun!

In the future, we might also reconstruct the cylinders made by Fuller, Thacher and others, in a variety of configurations.

Appended files

The following files supplement this article:

- `base24.pdf`: base tiling for a 24 m LOGA-type cylindrical slide rule (16 pages)
- `over24.pdf`: overlay tiling for a 24 m LOGA-type cylindrical slide rule (8 pages)
- `base2000.pdf`: base tiling for a 2000 m LOGA-type cylindrical slide rule (1160 pages)
- `over2000.pdf`: overlay tiling for a 2000 m LOGA-type cylindrical slide rule (600 pages)

¹²It would also be possible to go in the opposite direction and build much smaller cylindrical slide rules than the 1 m version from LOGA.

References

- [1] Silke Ackermann, Richard L. Kremer, and Mara Miniati, editors. *Scientific instruments on display*. Leiden: Brill, 2014.
- [2] Pierre Ageron. Ibn Hamza a-t-il découvert les logarithmes ? In *Circulation, transmission, héritage : actes du XVIII^e colloque Inter-Irem « Histoire et épistémologie des mathématiques », 28 et 29 mai 2010*, pages 339–359. Caen: IREM de Basse-Normandie, 2011.
- [3] Erhard Anthes and Ina Prinz. *Historische Rechenmaschinen, Arithmeum, Rheinische Friedrich-Wilhelms-Universität Bonn*, volume 353 of *Patrimonia*. Berlin: Kulturstiftung der Länder, 2010.
- [4] Julius Billeter. Rechentafel (German patent 43463), 1887.
- [5] Julius Billeter. Rouleau calculeur logarithmique (French patent 217367), 1891.
- [6] Julius Billeter. Rechenwalze (German patent 71715), 1893.
- [7] Julius Billeter. Logarithmic calculator (US patent 513172), 1894.
- [8] Max Billeter and August Bohnhorst. Rechenwalze (Swiss patent 80250), 1917.
- [9] Jacques Boyer. Les machines à calculer et leur utilisation pratique. *La science et la vie*, 12(34):345–355, Août-Septembre 1917. [p. 355 shows a cylindrical slide rule used in an office].
- [10] Donald Byal Bradner. Calculating machine (US patent 2,454,987), 1948. [A “machine” based on slide rules].
- [11] John Bryant and Chris Sangwin. *How round is your circle? Where engineering and mathematics meet*. Princeton: Princeton University Press, 2008.
- [12] Jost Bürgi. *Arithmetische und Geometrische Progress Tabulen, sambt gründlichem Unterricht, wie solche nützlich in allerley Rechnungen zugebrauchen, und verstanden werden sol*. Prague, 1620. [These tables were recomputed in 2010 by D. Roegel [55]].
- [13] Florian Cajori. Notes on the history of the slide rule. *The American Mathematical Monthly*, 15(1):1–5, 1908.

- [14] Florian Cajori. *A history of the logarithmic slide rule and allied instruments*. New York: Engineering news publishing Company, 1909.
- [15] Florian Cajori. A note on the history of the slide rule. *Bibliotheca Mathematica*, 10 (3rd series):161–163, 1909–1910.
- [16] Florian Cajori. On the history of Gunter’s scale and the slide rule during the seventeenth century. *University of California publications in mathematics*, 1(9):187–209, 1920.
- [17] Edwin J. Chamberlain. Long-scale slide rules. *Journal of the Oughtred society*, 8(1):24–35, 1999.
- [18] Edwin J. Chamberlain. Three American printed page logarithmic calculating scales. *Journal of the Oughtred society*, 11(1):8–13, 2002.
- [19] Richard Davis and Ted Hume. *All about slide rules*. Roseville: The Oughtred Society, 2012.
- [20] Luc de Brabandère. *Calculus : Les machines du calcul non électriques — Niet-elektrische Reken-machines — Non-electric calculating machines*. Liège: Pierre Mardaga, 1994.
- [21] Joaquín de Mendizábal-Tamborrel. *Tables des Logarithmes à huit décimales des nombres de 1 à 125000, et des fonctions goniométriques sinus, tangente, cosinus et cotangente de centimiligone en centimiligone et de microgone en microgone pour les 25000 premiers microgones, et avec sept décimales pour tous les autres microgones*. Paris: Hermann, 1891. [A sketch of this table was reconstructed by D. Roegel [54].].
- [22] Adalbert Duschek, Josef Lense, Theodor Radakovic, Frederik Zernike, and Karl Mader. *Mathematische Hilfsmittel in der Physik*. Berlin: J. Springer, 1928. [see pages 567–568].
- [23] James Jemison Fenton. Fuller’s calculating slide rule. *Transactions and Proceedings of the Royal Society of Victoria*, 22:57–61, 1886.
- [24] George Fuller. Calculator (US patent 219,246), 1879.
- [25] Ernst Hammer. Die Dämen-Schmid’sche Rechenwalze. *Zeitschrift für Vermessungswesen*, 38:909–912, 1909.
- [26] Peter M. Hopp. *Slide rules: Their history, models, and makers*. Mendham: Astragal press, 1999.

- [27] Louis Frédéric Gustave Jacob. *Le calcul mécanique*. Paris: Octave Doin et fils, 1911.
- [28] Heinz Joss. Rechenschieber — dem Vergessen entreissen ; Puisse la règle à calcul ne pas tomber dans l'oubli. *Vermessung, Photogrammetrie, Kulturtechnik : VPK = Mensuration, photogrammétrie, génie rural*, 95(6):430, 1997.
- [29] Heinz Joss. Messrechnen : 350 Jahre Rechenschieber. *Elemente der Mathematik*, 53(2):73–78, 1998.
- [30] Heinz Joss. Der Rechenschieber : Gestern alltäglich, heute vergessen. *Schweizer Ingenieur und Architekt*, 118(16):4–11, 2000.
- [31] Heinz Joss. Rechenwalzen, die Rechenschieber mit den langen Skalen. In Werner H. Schmidt and Werner Girbardt, editors, *1. Symposium zur Entwicklung der Rechentechnik, 15.–17. September 2000*, pages 11–33. Greifswald: Ernst Moritz Arndt Universität, 2000.
- [32] Heinz Joss. 350 Jahre Rechenschieber, und was die Region Zürich dazu beigetragen hat. *Vierteljahrsschrift der Naturforschenden Gesellschaft in Zürich*, 146(2-3):75–82, 2001.
- [33] Armand Julin. *Principes de statistique théorique et appliquée*, volume 1. Paris: Marcel Rivière, 1921. [a logarithmic cylinder is pictured on page 291].
- [34] Karl Kleine, editor. *Computing for science, engineering, and production: Mathematical tools for the second industrial revolution*. Norderstedt: Books on demand, 2013.
- [35] John Lawrence. Fuller's spiral slide rule. *Bulletin of the Scientific Instrument Society*, 98:40–41, 2008.
- [36] Timo Leipälä. On old Russian cylindrical and circular slide rules. *Journal of the Oughtred society*, 20(2):8–14, 2011.
- [37] Eugène Lemaire. Exposition publique de machines à calculer anciennes et modernes. *Bulletin de la Société d'encouragement pour l'industrie nationale*, 132:608–644, 1920.
- [38] Jean Marguin. *Histoire des instruments et machines à calculer — Trois siècles de mécanique pensante, 1642–1942*. Paris: Hermann, 1994.

- [39] Rudolf Mehmke. Numerisches Rechnen. In *Enzyklopädie der mathematischen Wissenschaften mit Einschluss ihrer Anwendungen*, volume 1-2, pages 938–1079. Leipzig: B. G. Teubner, 1900–1904. [Mehmke’s chapter was published in 1902. A French translation by Maurice d’Ocagne was published in the *Encyclopédie des sciences mathématiques pures et appliquées*, tome 1, volume 4, 1906–1911, fascicules 2 (1908) and 3 (1909), pages 196–452, under the title “Calculs numériques.”].
- [40] Musée national des techniques. *De la machine à calculer de Pascal à l’ordinateur : 350 ans d’informatique*. Paris: Musée national des techniques, CNAM, 1990.
- [41] John Napier. *Mirifici logarithmorum canonis descriptio*. Edinburgh: Andrew Hart, 1614.
- [42] William Nicholson. The principles and illustration of an advantageous method of arranging the differences of logarithms, on lines graduated for the purpose of computation. *Philosophical Transactions of the Royal Society of London*, 77:246–252, 1787.
- [43] Maurice d’Ocagne. *Traité de nomographie — Théorie des abaques — applications pratiques*. Paris: Gauthier-Villars, 1899. [see p. 360].
- [44] Maurice d’Ocagne. *Le calcul simplifié par les procédés mécaniques et graphiques*. Paris: Gauthier-Villars, 1905.
- [45] Maurice d’Ocagne. *Le calcul simplifié: graphical and mechanical methods for simplifying calculation*. Cambridge, MA: MIT Press, 1986. [Translation of the 1928 French edition.].
- [46] William Oughtred. *The circles of proportion and the horizontall instrument*. London, 1632.
- [47] Michael Podtiaguin. Règle à calcul logarithmique cylindrique et procédé d’établissement des échelles graduées pour cette règle (French patent 639.371), 1927.
- [48] Michael Podtjagin. Cylindrical slide rule (British patent 314609), 1928.
- [49] Михаил Евгеньевич Подтягина. Цилиндрическая логарифмическая счетная линейка (Soviet patent 9921), 1926.

- [50] Ina Prinz, editor. *Slide rules in the Arithmeum: The Schuitema collection*. Berlin: Nicolai, 2013. [pp. 125–129 on cylindrical slide rules].
- [51] John Robertson. The construction of the *logarithmic lines* on the *Gunter's scale*. *Philosophical Transactions of the Royal Society of London*, 48:96–103, 1753–1754.
- [52] Denis Roegel. A reconstruction of Edward Sang's table of logarithms (1871). Technical report, LORIA, Nancy, 2010. [This is a reconstruction of [60].].
- [53] Denis Roegel. A reconstruction of the "Tables des logarithmes à huit décimales" from the French "Service géographique de l'armée" (1891). Technical report, LORIA, Nancy, 2010. [This is a reconstruction of [61].].
- [54] Denis Roegel. A sketch of Mendizábal y Tamborrel's table of logarithms (1891). Technical report, LORIA, Nancy, 2010. [This is a sketch of Mendizábal's table [21].].
- [55] Denis Roegel. Bürgi's *Progress Tabulen* (1620): logarithmic tables without logarithms. Technical report, LORIA, Nancy, 2010. [This is a recalculation of the tables of [12].].
- [56] Denis Roegel. Napier's ideal construction of the logarithms. Technical report, LORIA, Nancy, 2010.
- [57] Werner H. Rudowski. Leibniz und sein logarithmischer Rechenzylinder, 2007.
www.rechenschieber.org/Leibniz.pdf.
- [58] Louis Antoine Marie Salomon. Note sur l'emploi des machines à écrire et à calculer par le service du matériel et de la traction de la Compagnie des chemins de fer de l'Est. *Revue générale des chemins de fer*, 19(4):189–209, 1896.
- [59] R. Bruce Sandie. Browne Fuller-type cylindrical slide rules. *Journal of the Oughtred Society*, 22(1):29–32, 2013.
- [60] Edward Sang. *A new table of seven-place logarithms of all numbers from 20 000 to 200 000*. London: Charles and Edwin Layton, 1871. [Reconstruction by D. Roegel, 2010 [52].].

- [61] Service géographique de l'Armée. *Tables des logarithmes à huit décimales des nombres entiers de 1 à 120000, et des sinus et tangentes de dix secondes en dix secondes d'arc dans le système de la division centésimale du quadrant publiée par ordre du Ministre de la guerre*. Paris: Imprimerie nationale, 1891. [Reprinted by the Institut Géographique National in 1944 and 1964, and reconstruction by D. Roegel, 2010.[53]].
- [62] Nico E. Smalenburg. *De LOGA calculators*. Oosterhout, 2004.
- [63] George R. Stibitz. Film slide rule. *Mathematical Tables and Aids to Computation*, 2(20):325, 1947.
- [64] George R. Stibitz. Film type of slide rule (US patent 2,710,142), 1955. [A "machine" based on slide rules].
- [65] Cliff Stoll. When slide rules ruled. *Scientific American*, 294(5):80–87, May 2006.
- [66] Edwin Thacher. Slide rule (US patent 249,117), 1881.
- [67] Edwin Thacher. *Thacher's calculating instrument or cylindrical slide-rule*. New York: D. Van Nostrand, 1884.
- [68] Gerard L'Estrange Turner. *Nineteenth-century scientific instruments*. Berkeley: University of California Press, 1983.
- [69] Gerard L'Estrange Turner. *Scientific instruments, 1500-1900: an introduction*. London: Philip Wilson publishers, 1998.
- [70] Hans-Joachim Vollrath. *Verborgene Ideen: Historische mathematische Instrumente*. Wiesbaden: Springer Spektrum, 2013.
- [71] Dieter von Jezierski. *Slide rules: a journey through three centuries*. Mendham: Astragal Press, 2000.
- [72] Dieter von Jezierski and David Rance. George R. Stibitz's Film Slide Rule: a computing machine with logarithmic scales, 2012. [with a correction in volume 21, number 2, page 43].
- [73] P. J. Wallis. William Oughtred's 'circles of proportion' and 'trigonometries'. *Transactions of the Cambridge Bibliographical Society*, 4:372–382, 1968.

- [74] Friedrich Adolf Willers. *Mathematische Instrumente*. Berlin: Walter de Gruyter & Co, 1926. [see pp. 21–22 for logarithmic cylinders].
- [75] Friedrich Adolf Willers. *Mathematische Maschinen und Instrumente*. Berlin: Akademie-Verlag, 1951. [see pp. 3–4 for logarithmic cylinders].