



HAL
open science

An aperiodic set of 11 Wang tiles

Emmanuel Jeandel, Michael Rao

► **To cite this version:**

| Emmanuel Jeandel, Michael Rao. An aperiodic set of 11 Wang tiles. 2020. hal-01166053v3

HAL Id: hal-01166053

<https://inria.hal.science/hal-01166053v3>

Preprint submitted on 13 Dec 2020 (v3), last revised 21 Nov 2021 (v4)

HAL is a multi-disciplinary open access archive for the deposit and dissemination of scientific research documents, whether they are published or not. The documents may come from teaching and research institutions in France or abroad, or from public or private research centers.

L'archive ouverte pluridisciplinaire **HAL**, est destinée au dépôt et à la diffusion de documents scientifiques de niveau recherche, publiés ou non, émanant des établissements d'enseignement et de recherche français ou étrangers, des laboratoires publics ou privés.

An aperiodic set of 11 Wang tiles

Emmanuel Jeandel and Michaël Rao

September 21, 2020

Abstract

We present a new aperiodic tileset containing 11 Wang tiles on 4 colors, and we show that this tileset is minimal, in the sense that no Wang set with either fewer than 11 tiles or fewer than 4 colors is aperiodic. This gives a definitive answer to the problem raised by Wang in 1961.

Wang tiles are square tiles with colored edges. A tiling of the plane by Wang tiles consists of placing a Wang tile in each cell of the grid \mathbb{Z}^2 so that contiguous edges share the same color. The formalism of Wang tiles was introduced by Wang [Wan61] to study decision procedures for a specific fragment of logic (see Section 1.1 for details).

Wang posed the question of whether an aperiodic tileset exists: a set of Wang tiles which tiles the plane but cannot do so periodically. His student Berger quickly gave an example of such an aperiodic tileset, but it consisted of a very large number of tiles. The number of tiles needed was eventually reduced by Berger himself and then by others, to achieve an aperiodic set of only 13 Wang tiles in 1996 (see Section 1.2 for an overview of previous aperiodic sets of Wang tiles). Their work in this apparently tedious exercise introduced several novel techniques to build aperiodic tilesets, and also to prove aperiodicity.

Other work has established that it is impossible to obtain an aperiodic tileset with 4 tiles or less [GS87], and that it is also impossible to obtain aperiodic set of Wang tiles with fewer than 4 colors [CHLL14].

In this article, we fill all the gaps: we prove that there is an aperiodic tileset with 11 Wang tiles and 4 colors, and we also prove that there is no aperiodic tileset with fewer than 11 Wang tiles.

The discovery of this tileset, and the proof that there is no smaller aperiodic tileset, was achieved by a computer search, which generated all possible candidates with 11 tiles or less.

We proved that they were not aperiodic with 10 tiles or fewer. Surprisingly, it was somewhat easy to do so for all of them except one. The situation is different for 11 tiles: while we have found an aperiodic tileset, we also have a short list of tilesets which we are yet to characterize. This computer search is described in Section 3, along with a result of independent interest: we show that the tileset by Culik does not tile the plane if one tile is omitted. This section can be skipped by a reader who is only interested in our tileset itself. The tileset

is presented in Section 4, and the remaining sections prove that it is indeed an aperiodic tiling set.

1 Aperiodic sets of Wang tiles

The following is a brief summary of the known aperiodic Wang tilesets, for which further detail can be found in [GS87].

1.1 Wang tiles and the $\forall\exists\forall$ problem

Wang tiles were introduced by Wang in 1961 [Wan61], to study the decidability of the $\forall\exists\forall$ fragment of first order logic. In his article, Wang showed how to build a tileset τ and a subset $\tau' \subseteq \tau$ so that there exists a tiling by τ of the upper quadrant, with tiles in the first row in τ' if and only if ϕ is satisfiable. He builds this tileset starting from a $\forall\exists\forall$ formula ϕ . In his development, the decidability of this particular tiling problem would imply that the satisfiability of $\forall\exists\forall$ formulas was decidable.

More generally, Wang asked whether the more general tiling problem (with no particular tiles in the first row) is decidable. He posed the fundamental conjecture: every tileset either admits a periodic tiling or it does not tile.

The following year, without having proven the conjecture above, Kahr, Moore and Wang [KMW62] proved that the $\forall\exists\forall$ problem is indeed undecidable. They did so by reducing it to another tiling problem: we fix a subset τ' of tiles so that every tile on the diagonal of the first quadrant is in τ' . This proof was later simplified by Hermes [Her71, Her70]. From the point of view of first order logic, the problem is therefore solved. Formally speaking, the tiling problem with this diagonal constraint is reduced to a formula of the form $\forall x\exists y\forall z\phi(x, y, z)$ where ϕ contains a binary predicate P and occurrences of the subformula $P(x, x)$, which code the diagonal constraint. If we look at $\forall\exists\forall$ formulas that do not contain the subformula $P(x, x)$ and $P(z, z)$, the decidability of this particular fragment remained open.

However, Berger proved a few years later [Ber64] both that the domino problem is undecidable, and that an aperiodic tileset exists. This implies that the fragment of $\forall x\exists y\forall z$ where the only occurrence of the binary predicates P are of the form $P(x, z), P(y, z), P(z, y), P(z, x)$ is undecidable.

Over the years, other subcases of $\forall\exists\forall$ were described. In 1975, Aanderaa and Lewis [AL74] proved the undecidability of the fragment of $\forall\exists\forall$ where the binary predicates P can only appear in the form $P(x, z)$ and $P(z, y)$. Their proof has the consequence that: the domino problem for deterministic tilesets is undecidable.

1.2 Aperiodic tilesets

The first set of Wang tiles was provided by Berger in 1964. The set contained in the 1966 AMS publication [Ber66], has 20426 tiles, but Berger's original PhD

Thesis [Ber64] also contains a simplified version with 104 tiles. It should be noted that there is a mistake in Berger’s paper: namely that 3 tiles are missing and 4 tiles are unneeded, bringing the actual tileset to 103 tiles. This tileset is of a substitutive nature. Knuth [Knu68] gave another simplified version of Berger’s original set, with 92 tiles (6 of which are actually unneeded, bringing the number 86).

In 1966, Lauchli obtained an aperiodic set of 40 Wang tiles, which is published in a 1975 paper by Wang [Wan75].

In 1967, Robinson found an aperiodic set of 104 tiles, which was mentioned only in a Notice of the AMS summary [Rob67]. Two simplifications of this tileset exist: first, Poizat describes a tileset of 52 tiles [Poi80]. Second, a tileset of 56 tiles was published by Robinson in 1971 [Rob71] and is probably his most well-known tileset. In that paper, he hints at a set of 35 Wang tiles.

Later, Robinson managed to lower the number of tiles again to 32 using an idea by Roger Penrose. The same idea is used by Grunbaum and Shephard to obtain an aperiodic set of 24 tiles [GS87]. In 1977, Robinson obtained a set of 24 tiles from a tiling method by Ammann. For a long time the record was held by Ammann, who obtained, in 1978, a set of 16 Wang tiles. When available, details on these tilesets are provided in [GS87].

In 1975, Aanderaa and Lewis [AL74] build the first aperiodic deterministic tileset. No details about the tileset are provided but it is possible to extract one from the exposition by Lewis [Lew79]. This construction was somehow forgotten in the literature, and the first aperiodic deterministic tileset is usually attributed to Kari in 1992 [Kar92].

In 1989, Mozes showed a general method that can be used to translate any substitution tiling into a set of Wang tiles [Moz89], which will be, of course, aperiodic. There are multiple generalizations of this result (depending on the exact definition of “substitution tiling”), of which we cite only a few [GS98, FO10, IGO12]. For a specific example, Socolar built such a representation [Sen95] of the chair tiling, which, in our vocabulary, can be done using 64 tiles.

The story stopped until 1996, when Kari invented a new method to build aperiodic tileset, obtaining an aperiodic set of 14 tiles [Kar96]. This was reduced to 13 tiles by Culik [Cul96] using the same method. There was speculation that one of the 13 tiles was unnecessary, and an unpublished manuscript by Kari and Culik hints at a method to show it. However, this is not true: the method developed in the present article will show this is not the case.

In 1999, Kari and Papasoglu [KP99] presented the first 4-way deterministic aperiodic set. The construction was later adapted by Lukkarilla to provide a proof of undecidability of the 4-way domino problem [Luk09].

The construction by Robinson was later analyzed [Sal89, AD01, JM97, GJS12] and simplified. In 2004, Durand, Levin, and Shen presented [DLS04] a way to simplify exposition of proofs of aperiodicity of such tilesets. Ollinger used this method in 2008 to obtain an aperiodic tileset with 104 tiles [Oll08], which is likely a rediscovery of the unpublished tileset by Robinson. Other simplifications of Robinson constructions were given by Levin in 2005 [Lev05] and Poupet in 2010 [Pou10], using ideas similar to Robinson.

In 2008, Durand, Romashchenko, and Shen provided a new construction based on the classical fixed point construction from computability theory [DSR08, DRS12].

2 Preliminaries

2.1 Wang tiles

A Wang tile is a unit square with colored edges. Formally, let H, V be two finite sets (the horizontal and vertical colors, respectively). A wang tile $t = (t_w, t_e, t_s, t_n)$ (for west, east, south and north) is an element of $H^2 \times V^2$. Thus, the horizontal colors are used on west and east sides (that is, horizontal edges of the square), and vertical colors are used in north and south side (that is, vertical edges).

A Wang set is a set of Wang tiles, formally viewed as a tuple (H, V, T) , where $T \subseteq H^2 \times V^2$ is the set of tiles. Figure 1 presents a well-known example of a Wang set. A Wang set is said to be empty if $T = \emptyset$.

Let $\mathcal{T} = (H, V, T)$ be a Wang set. Let $X \subseteq \mathbb{Z}^2$. A tiling of X by \mathcal{T} is a mapping from X to \mathcal{T} so that contiguous edges have the same color; that is, it is a function $f : X \rightarrow T$ such that $f(x, y)_e = f(x+1, y)_w$ and $f(x, y)_n = f(x, y+1)_s$ for every $(x, y) \in \mathbb{Z}^2$ when the function is defined. We are especially interested in the tilings of \mathbb{Z}^2 by a Wang set \mathcal{T} . When we say a tiling of the plane by \mathcal{T} , or simply a tiling by \mathcal{T} , we mean a tiling of \mathbb{Z}^2 by \mathcal{T} .

A tiling f is periodic if there is a $(u, v) \in \mathbb{Z}^2 \setminus (0, 0)$ such that $f(x, y) = f(x+u, y+v)$ for every $(x, y) \in \mathbb{Z}^2$. A tiling is aperiodic if it is not periodic.

A Wang set tiles X (resp. tiles the plane) if there exists a tiling of X (resp. the plane) by \mathcal{T} . A Wang set is finite if there is no tiling of the plane by \mathcal{T} . A Wang set is periodic if there is a tiling t by \mathcal{T} which is periodic. A Wang set is aperiodic if it tiles the plane, and every tiling by \mathcal{T} is not periodic.

To quote a few well-known folklore results:

Lemma 1. *If \mathcal{T} is periodic, then there is a tiling t by \mathcal{T} with two linearly independent translation vectors (in particular a tiling t with vertical and horizontal translation vectors).*

Lemma 2. *If, for every $k \in \mathbb{N}$, there exists a tiling of $[0, \dots, k] \times [0, \dots, k]$ by \mathcal{T} , then \mathcal{T} tiles the plane.*

2.2 Transducers

One of the simplest but most crucial observations we will use in this article is that a Wang set may be viewed as a finite state transducer: a finite state automata with an input tape and an output tape. In the entire paper, we use the same notation for Wang sets and for transducers, that is, a transducer is a triplet (H, V, T) , where H is the set of states, V is the (input and output) alphabet, and T is the set of transitions. Each $t = (w, e, s, n) \in T$ is a transition (in other words, a tile in the Wang set formalism), and the transducer authorizes the transition from the state w to the state e , reading the letter s on the input tape and writing n on the output state. It should be noted that, unlike usual automata and finite state transducers, we do not have either initial or final states: we work on biinfinite words.

Figure 1 presents the popular set of Wang tiles introduced by Culik from both points of view. Note that we choose to label transitions with $s|n$ instead of, for example, $\frac{n}{s}$. This choice is intended to adhere to the classical way of depicting finite state transducers.

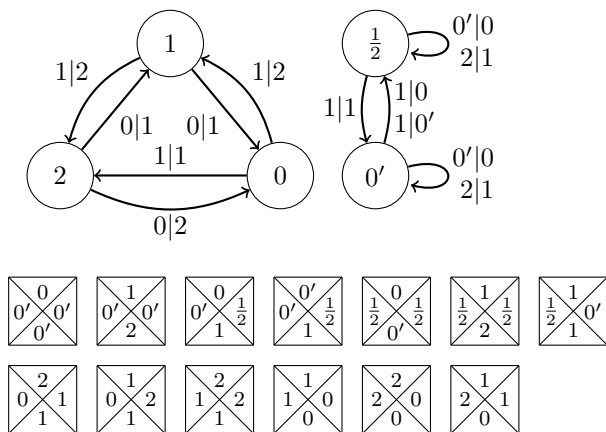

Figure 1: The aperiodic set of 13 tiles obtained by Culik from an idea by Kari: the transducer view and the tile view.

A biinfinite word (or biinfinite sequence) on the alphabet A is a sequence $(w_i)_{i \in \mathbb{Z}}$ such that, for every $i \in \mathbb{Z}$, $w_i \in A$. If w and w' are biinfinite words over the alphabet V , we will write $w\mathcal{T}w'$ if w' is the image of w by the transducer. More formally, $w\mathcal{T}w'$ if there is a biinfinite sequence $(q_i)_{i \in \mathbb{Z}}$ of states such that for every $i \in \mathbb{Z}$, $(q_i, q_{i+1}, w_i, w'_i) \in T$. In Wang tile formalism, $w\mathcal{T}w'$ if one can tile a row such that w are the sequence of colors on south edges, and w' the color on north edges. The transducer is usually nondeterministic, so this is indeed a partial relation, not a function.

A run of a transducer \mathcal{T} is a (possibly infinite or biinfinite) sequence of biinfinite words $(w_i)_{i \in I}$ (where I is an interval of \mathbb{Z}) such that, for all $\{i, i + 1\} \subset I$, $w_i\mathcal{T}w_{i+1}$. In this formalism, tilings of the plane correspond exactly

to biinfinite runs of the transducer, and (H, V, T) tiles the plane if and only if there exists a biinfinite run of (H, V, T) . Note also that, by compactness, there exists a biinfinite run of (H, V, T) if and only if there exists an infinite run of (H, V, T) .

The composition of Wang sets, seen as transducers, is straightforward: let $\mathcal{T} = (H, V, T)$ and $\mathcal{T}' = (H, V', T')$ be two Wang sets. Then $\mathcal{T} \circ \mathcal{T}'$ is the Wang set $(H \times H', V, T'')$, where

$$T'' = \{((w, w'), (e, e'), s, n') : (w, e, s, n) \in T, (w', e', s', n') \in T' \text{ and } n = s'\}.$$

Let \mathcal{T}^k , $k \in \mathbb{N} \setminus \{0\}$ be \mathcal{T} if $k = 1$, $\mathcal{T}^{k-1} \circ \mathcal{T}$ otherwise.

A reformulation of the original question is as follows:

Lemma 3. *A Wang set \mathcal{T} is finite if there is no infinite run of the transducer \mathcal{T} : there is no biinfinite sequence $(w_k)_{k \in \mathbb{N}}$ so that $w_k \mathcal{T} w_{k+1}$ for all k .*

A Wang set \mathcal{T} is periodic if and only if there exists a biinfinite word w and a positive integer k so that $w \mathcal{T}^k w$.

We will also use the following operations on tilesets (or transducers):

rotation Let \mathcal{T}^{tr} be (V, H, T') where $T' = \{(s, n, e, w) : (w, e, s, n) \in T\}$. This operation corresponds to a rotation of the tileset by 90 degrees.

simplification Let $s(\mathcal{T})$ be the operation that deletes from \mathcal{T} any tile that cannot be used in a tiling of a (biinfinite) line row by \mathcal{T} . From the point of view of transducers, this corresponds to eliminating sources and sinks from \mathcal{T} . In particular, $s(\mathcal{T})$ is empty if and only if there are no biinfinite words w, w' s.t. $w \mathcal{T} w'$.

union $\mathcal{T} \cup \mathcal{T}'$ is the disjoint union of transducers \mathcal{T} and \mathcal{T}' : we first rename the states of both transducers so that they are all different, and then we take the union of the transitions of both transducers. Thus $w(\mathcal{T} \cup \mathcal{T}')w'$ if and only if $w \mathcal{T} w'$ or $w \mathcal{T}' w'$.

Equivalence of Wang sets. Once Wang sets are seen as transducers, it is easy to see that the problems under consideration do not actually depend on \mathcal{T} , but only on the relation induced by \mathcal{T} : We say that two Wang sets $\mathcal{T} = (H, V, T)$ and $\mathcal{T}' = (H', V, T')$ are equivalent if they are equivalent as relations. In other words: for every pair of biinfinite words (w, w') over V , $w \mathcal{T} w' \Leftrightarrow w \mathcal{T}' w'$.

In the course of the following proofs and algorithms, it will be useful to switch between equivalent Wang sets (transducers), in particular by trying to simplify the sets as much as possible. For example, we can apply the operator $s(\mathcal{T})$ to trim the colors/states (and thus the tiles/transitions) that cannot appear in a biinfinite row (e.g., sources/terminals of the transducer seen as a graph), or reduce the size of the transducer by coalescing “equivalent” states.

There are a few algorithms to simplify Wang sets. First, as our transducers are nothing but (nondeterministic) finite automata over the alphabet $V \times V$, it is tempting to try to minimize them. However, state (or transition) minimization

of nondeterministic automata is PSPACE-complete [MS72]. Another plausible strategy, building the minimal deterministic automaton, has also proven to be inefficient in practice. The algorithm we use is based on the notion of strong bisimulation equivalence (or bisimulation, for short) of labeled transitions systems [KS90, PT87, Val10, Luc03].

A simulation on the transducer (H, V, T) is a relation $R \subseteq H^2$ such that for every $u, u', v \in H$ and $a, b \in V$ such that $(u, u') \in R$ and $(u, v, a, b) \in T$, there exists $v' \in V$ such that $(u', v', a, b) \in T$. A bisimulation is a relation R such that R and R^{-1} are simulations. The bisimilarity relation, which is the largest possible bisimulation, is an equivalence relation, can be computed in linear time [PT87]. The computation of the bisimilarity relation can be thought of as the non-deterministic equivalent of Hopcroft's [Hop71] classical minimization algorithm for deterministic automata. Note that if we collapse equivalence classes in the transducer, we obtain a new transducer which is equivalent to the previous one.

Another interesting option to simplify a transducer is the simulation relation, but the best known algorithm to compute it is in $O(n'm)$ time [Céc17], with n' the number of equivalence classes, and m the number of transitions, which makes it impractical to use on large transducers. More so in our case, which sees transducers of up to several billions of transitions.

3 There is no aperiodic Wang sets with 10 tiles or less

In this section, we present a computer-assisted proof that there is no aperiodic Wang set with 10 tiles or less. The computer program can be found here: [JR19].

The general idea of the algorithm is straightforward: generate all Wang sets with 10 tiles or less, and test each one to see whether it is aperiodic. This method presents two difficulties here: first, there are a large number of Wang sets with 10 tiles: for maximum efficiency, we have to discard as soon as possible Wang sets that are provably not aperiodic. We then have to test the remaining sets for aperiodicity. Because aperiodicity is an undecidable problem, our algorithm will not succeed on all Wang sets; the remaining sets will have to be examined by hand.

3.1 Generating all Wang sets with 10 tiles or less

According to the general principle above, we do not actually have to generate all Wang sets: we can refrain from generating sets that we know to be aperiodic.

Let \mathcal{T} be a Wang set. We say that \mathcal{T} is minimally aperiodic if \mathcal{T} is aperiodic and no proper subset of \mathcal{T} is aperiodic (that is no proper subset of \mathcal{T} tiles the plane). We will introduce criteria proving that some Wang sets are not minimally aperiodic, and thus that we do not need to test them.

The key idea is to look at the graph G underlying the transducer, that is, the transducer in which we neglect the labels of transitions. Note that this is

actually a multigraph: there might be multiple edges (transitions) joining two given vertices (states), and there might also be self-loops.

This approach was introduced in [JR12], and the following lemma is more or less implicit in this article:

Lemma 4. *Let \mathcal{T} be a Wang set, and G the corresponding graph.*

- *Suppose there exist two vertices/states/colors $u, v \in G$ so that there is an edge (hence a tile/transition) from u to v and no path from v to u . Then \mathcal{T} is not minimal aperiodic.*
- *Suppose G contains a strongly connected component which is a cycle. Then \mathcal{T} is not minimal aperiodic.*
- *If G has only one vertex, then \mathcal{T} is not aperiodic.*
- *If the difference between the number of edges and the number of vertices in G is less than 2, then \mathcal{T} is not minimal aperiodic.*

Proof. In terms of tiles, the first case corresponds to a tile t which can appear at most once in each row. If \mathcal{T} tiles the plane, \mathcal{T} tiles arbitrarily large regions without using the tile t . By compactness (Lemma 2), $\mathcal{T} \setminus \{t\}$ tiles the plane.

For the second case, suppose such a component exists. This means there exist some tiles $S \subseteq \mathcal{T}$ so that every time one of the tiles in S appears, then the whole row is periodic (of period the size of the cycle). If \mathcal{T} is aperiodic, we cannot have a tiling where tiles of S appear in two different rows, as we could deduce from it a periodic tiling. As a consequence, tiles from S appear in at most one row, and using the same compactness argument as before we deduce that $\mathcal{T} \setminus S$ tiles the plane.

For the third case, if G has only one vertex and the Wang set tiles the plane, then one can construct a periodic tiling of the plane such that every column is the same column.

The proof of the fourth case can be found in [JR12]. □

We also suppose w.l.o.g. that there are no isolated vertices. The number of graphs with the property of Lemma 4 are: 6 for 4 edges, 26 for 5 edges, 122 for 6 edges, 516 for 7 edges, 2517 for 8 edges, 13276 for 9 edges and 77809 for 10 edges. The computer program `gengraphs__N` generates the set of such graphs with N edges.

This lemma gives a bird’s-eye view of the program: for a given $n \leq 10$, generate the set \mathcal{G} of all graphs with n edges and at most $n-2$ vertices satisfying the hypotheses of the lemma. Then for every G_1 and G_2 in \mathcal{G} , we test all Wang sets for which the first underlying graph (in west/east sides) is G_1 , and the underlying graph of \mathcal{T}^{tr} (that is, the north/south sides of \mathcal{T}) is G_2 . To do so, we test every bijection between the edges of G_1 and the edges of G_2 . In terms of Wang tiles, a graph corresponds to a specific assignment of colors to the east/west side: for this particular assignment, we test all possible assignments of colors to the north/south side. The exact approach used in the software

follows this principle, trying as much as possible not to generate isomorphic tilesets.

3.2 Testing Wang sets for aperiodicity

In the previous section, we described how we generated Wang sets to test. We now describe how we tested them for aperiodicity.

3.2.1 Main program

Recall that a Wang set is not aperiodic if

- either there exists k so that $s(\mathcal{T}^k)$ is empty: there are no word w, w' so that $w\mathcal{T}^kw'$,
- or there exists k so that \mathcal{T}^k is periodic: there exists a word w so that $w\mathcal{T}^kw$.

The general algorithm to test for aperiodicity is therefore clear: for each k , generate \mathcal{T}^k , and then test whether one of the two cases occurs. If it does, the set is not aperiodic. Otherwise, we go to the next k . The algorithm stops when the computer program runs out of memory. In that case, the algorithm was not able to decide if the Wang set was aperiodic (it is after all an undecidable problem), and we have to examine the Wang set carefully.

This approach works quite well in practice: when launched on a computer with a reasonable amount of memory, it eliminates a very large number of tilesets. Of course, the key idea is to simplify \mathcal{T}^k as much as possible, before computing \mathcal{T}^{k+1} . Note that this should be done as fast as possible, as this will be done for all Wang sets. It turns out that the easy simplification of deleting at each step the tiles that cannot appear in a tiling of a row (i.e., vertices that are sources/terminals) is already sufficient.

It is important to note that this approach, relying on transducers (test whether the Wang set tiles k consecutive rows, and whether it does so periodically) turned out in practice to be much more efficient than the naive approach of using tilings of squares (test whether the Wang set tiles a square of size k , and whether it does so periodically).

At this point, several possible improvements become apparent. For example, the simplification of the transducers by bisimulation can be significant.

However, we have to be careful about a few things. Firstly, some techniques can paradoxically waste more time than they save: the large majority of tilesets are quickly discarded by a simple and naive algorithm, and the time spent on non-trivial cases represents only a tiny part of the overall time, even with this simple algorithm. Secondly, these optimizations can make the program more difficult to read, to understand, and to check.

Where this is the case, we have chosen to opt for program clarity rather than computational efficiency: without other improvements, one can show, in a reasonable time, that there is no aperiodic set of Wang tiles with at most

10 tiles. For example, we do not even try to remove duplicate tiles, since this operation would require sorting the tiles.

3.3 Computation

Two independent programs [JR19] are available in the folder *src*, and another in the folder *alternative*. The result from both programs is the same: we find only one hard case up to isomorphism, which is discussed in Section 3.3.1.

We now give some details on the computation for the first program (the second is quite similar). The computation for 10 tiles was done using the PSMN cluster (Pôle Scientifique de Modélisation Numérique) of the ENS de Lyon, and the computing resources of the LIP (Laboratoire d’Informatique du Parallélisme) of the ENS de Lyon, and required approximately 23 CPU years, that is roughly one week on 1000 cores. For 9 tiles and less, the computations required approximately 38 CPU days.

For 10 tiles, there are $(77809 \times 77810)/2 \sim 3 \times 10^9$ cases. (By a case, we mean the test of all possible bijections between the edges of two graphs.) Most of the cases (99.8%) take less than 1 second: the average time is 242ms and the median time is 155ms. Except for the hardest case discussed below, the largest power we have to compute is \mathcal{T}^{126} , and the largest transducer has $\sim 18 \times 10^6$ transitions – recall, however, that the program does not try to keep the transducer small.

It is difficult to recheck the result without substantial computing power. As a kind of certificate, we provide all the hardest cases for 10 tiles: cases where either we have to compute at least \mathcal{T}^{30} , or cases for which we get a transducer with at least 10^4 edges. We also give the hardest cases for sets of 5 up to 9 tiles.

3.3.1 The hardest case

Among all Wang sets, only 4 sets cannot be proven to be not aperiodic by the computer program. All these 4 sets are isomorphic to the set T_h presented in Figure 2.

It turned out that this particular Wang set is a special case of a general construction introduced by Kari [Kar96] of aperiodic Wang sets, save for the fact that a few tiles are missing. At this point, the situation could have become desperate: it is not known whether Wang sets which were obtained by the method of Kari less a few tiles actually tile the plane. In fact, the question was open: whether it was possible to delete a tile from Culik’s [Cul96] 13 tileset to obtain a set that still tiles the plane¹. It was conjectured by both Kari and Culik that it was indeed possible.

We were able to prove that this tileset does not in fact tile the plane. Wang sets belonging to the family identified by Kari all work in the same way: the

¹You will find many experts on tilings that recollect this story wrongly and think that the (13) Wang set by Culik is the (14) Wang set from Kari with one tile removed. This is not the case. What happened is that there is one tile from the (13) Wang set by Culik that seemed likely to be unnecessary.

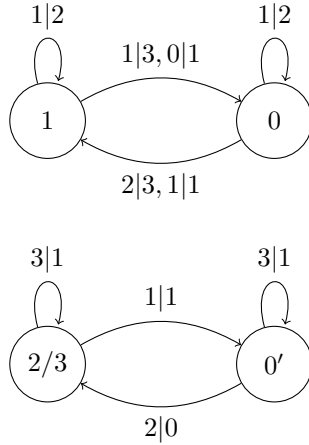

Figure 2: The set T_h of 10 tiles that comes very close, but fails to tile the plane. It tiles a square of size 212×212

biinfinite words that appear on each row can be thought of as reals, by taking the average of all numbers (between 0 and 3 in our example) that appear on the row. Then, what the tileset does is apply a given piecewise affine map to the real number. In the case of our set of 10 tiles, the map f is as follows:

- if $1/2 \leq x < 3/2$, then $f(x) = 2x$,
- if $3/2 < x \leq 3$, then $f(x) = x/3$.

As can be seen from the first transducer, there cannot be two consecutive 0 in x . This guarantees that $x \geq 1/2$, therefore $x \neq 0$, and, in particular, that this tileset has no periodic tiling.

If we used Kari's method to code this particular tileset, the transducer that divides by 3 would have 8 tiles. However, our particular set of 10 tiles does so with only 4 tiles. There is a way to explain how the division by 3 works. First, we treat it like a multiplication by 3 by reversing the process. Recall that the Beatty expansion of a real x is given by $\beta_n(x) = \lceil (n+1)x \rceil - \lceil nx \rceil$. Then one has

Fact 1. *Let $0 < x \leq 1$ and define $b_n(x) = 2\beta_n(2x) - \beta_n(x)$. Then the second transducer transforms $(\beta_n)_{n \in \mathbb{N}}$ into $(b_n)_{n \in \mathbb{N}}$.*

Therefore, the second transducer multiplies by 3 by doing $2 \times 2 \times x - x$ somehow. It can be seen as a composition of a transducer that transforms $(\beta_n)_{n \in \mathbb{N}}$ into $(\beta_n, b_n)_{n \in \mathbb{N}}$ (this can be done with only two states, using Kari's method) and a transducer mapping each symbol (x, y) into $2y - x$, which can be done using only one state (this is just a relabeling).

There is no reason that doing the transformation this way would work (in particular the equations given by Kari cannot be applied to this particular

transducer and prove that there is a tiling of the plane), and indeed it doesn't: we were able to prove that this particular Wang set does not tile the plane.

Once this tileset was identified as belonging to the family of Kari tilesets, it is easy to see that, should it tile the plane, it tiles a half plane starting from a word consisting only of the symbol 3.

Fact 2. *If T_h tiles the plane, then it tiles a half plane starting from a word consisting only of the symbol 3.*

Proof. If one has a tiling of the plane, there is a biinfinite run (w_i) of T_h . For $i, n \in \mathbb{N}$, let $x_{i,n}$ be the sum of the letters in w_i (considering the letters as real numbers) between the positions $-n$ and n . The sequence $(x_{0,n}/(2n+1))_{n \in \mathbb{N}}$ is bounded, thus one can find an increasing function $\phi : \mathbb{N} \mapsto \mathbb{N}$ such that $x_{0,\phi(n)}/(2\phi(n)+1)$ converges. Let $y_0 = \lim_{n \rightarrow \infty} x_{0,\phi(n)}/(2\phi(n)+1)$. Then $(x_{1,\phi(n)}/(2\phi(n)+1))_{n \in \mathbb{N}}$ converges, and by induction, for every $i \in \mathbb{N}$, $(x_{i,\phi(n)}/(2\phi(n)+1))_{n \in \mathbb{N}}$ converges. Let $y_i = \lim_{i \rightarrow \infty} x_{i,\phi(n)}/(2\phi(n)+1)$.

Moreover, for every i , one has either $y_{i+1} = 2y_i$ or $y_{i+1} = y_i/3$. One can suppose w.l.o.g. that for every $k \in \mathbb{N}$, $y_k \neq 3/2$. Otherwise, it is impossible that $y_{k'} = 3/2$ with $k' > k$, and one can replace the initial sequence by $(w_{i+k+1})_i$.

Thus, $y_i = f^i(y_0)$. Since $\log(2)/\log(3)$ is irrational, the set $\{y_i\}$ is dense, and for every $\epsilon > 0$ there is an i such that $|y_i - 3| < \epsilon$. That is, for every $n \in \mathbb{N}$, the factor 3^n appears as a factor of one w_i . By compactness, there is a tiling of the half plane starting from a word consisting only of the symbol 3. \square

In our approach, we started from a transducer \mathcal{T}' which outputs a configuration with only the symbol 3, and built recursively $t_k = \mathcal{T}'\mathcal{T}^k$.

It turns out that t_{31} is empty, once reduced, which means that we cannot tile 31 consecutive rows starting from a word consisting only of 3. This fact is verified by the program `hard10`. Here, the naive approach –to remove sources and terminals– takes too long for t_{31} , and we opted to use Tarjan's algorithm to find strongly connected components.

Fact 3. *T_h does not tile the plane.*

Thus, we get:

Theorem 1. *There is no aperiodic Wang set with 10 tiles or less.*

The fact that everything falls apart for $k = 31$ can be explained intuitively, if we identify $([0.5, 3]_{0.5 \sim 3}, \times)$ with the unit circle $([0, 1]_{0 \sim 1}, +)$. What f is doing is now just an addition (modulo 1) of $\frac{\log 2}{\log 2 + \log 3}$. Now $31 \frac{\log 2}{\log 2 + \log 3} = 11.992$ is near an integer, which means that \mathcal{T}^{31} is "almost" the identity map. During the 30 first steps, our map \mathcal{T} is able to deceive us, and it appears as if it would tile the plane by using the degrees of freedom we have in the coding of the reals. For $k = 31$, this is not possible anymore.

Before removing unused transitions, t_{31} contains a path of 212 symbols 3. This means in particular that there exists a tiling of a rectangle of size 212×31

where the top and the bottom sides are equal, thus a tiling of a biinfinite vertical strip of width 212 by this tiling, and thus a tiling of a square of size 212×212 .

It turns out that the exact same method can be used for the set of 12 tiles obtained from Culik's set by removing one tile. It corresponds to the same rotation, and we observe indeed the same behavior: starting from a configuration of all 2, it is not possible to tile 31 consecutive rows:

Theorem 2. *The set of 13 tiles by Culik is minimal aperiodic: if any tile is removed from this set, it does not tile the plane anymore.*

Note that the situation is still not well understood, and we consider ourselves lucky to have obtained the result: first, we have to execute the transducers in the right direction: $\mathcal{T}'\mathcal{T}^{-31}$ is nonempty. Furthermore, the next step when \mathcal{T}^k returns near an integer is for $k = 106$, and no computer, using our technique, has enough memory to hope computing \mathcal{T}^{106} .

Conjecture 1. *Every aperiodic tileset obtained by Kari's method is minimal aperiodic.*

4 An aperiodic Wang set of 11 tiles - Proof sketch

Using a similar method to the one presented in the last section, we were able to enumerate and test sets of 11 tiles and find a few potential candidates. This computation took approximately one year on several hundred cores, using again the PSMN cluster and the LIP cluster.

Of these few candidates, three of them were extremely promising, and we will prove that they are aperiodic sets. These three sets look very similar, and the core of the proof of their aperiodicity is the same.

One of these three sets, \mathcal{T}' (Figure 4), uses only four colors, which is also minimal because no aperiodic set exists with only three colors [CHLL14]. To prove that \mathcal{T}' is aperiodic, we first show that \mathcal{T} (Figure 3) is aperiodic, and then show that \mathcal{T}' , which is a simple modification of \mathcal{T} , is aperiodic. The aperiodicity of the last set \mathcal{T}'' (Figure 10) is discussed in Section 7.3.

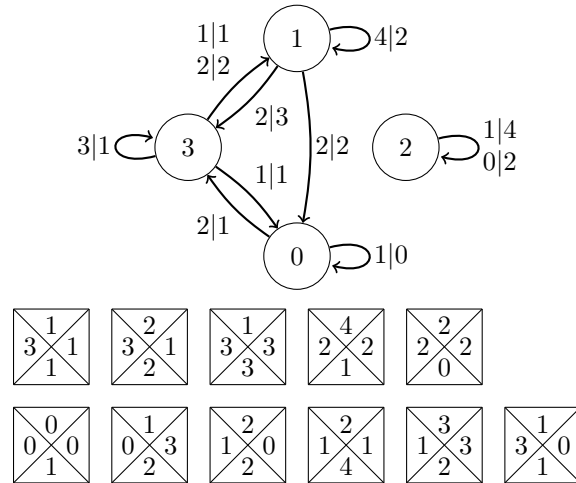

Figure 3: Wang set \mathcal{T} .

Theorem 3. *The Wang sets of Figure 3, 4 and 10 are aperiodic.*

In this section, we sketch the proof of this result for the first set \mathcal{T} .

\mathcal{T} is the union of two Wang sets, \mathcal{T}_0 and \mathcal{T}_1 , of 9 and 2 tiles respectively. For $w \in \{0, 1\}^* \setminus \{\epsilon\}$, let $\mathcal{T}_w = \mathcal{T}_{w[1]} \circ \mathcal{T}_{w[2]} \circ \dots \circ \mathcal{T}_{w[|w|]}$.

It can be seen by an easy computer verification that every tiling by \mathcal{T} can be decomposed into a tiling by transducers $\mathcal{T}_1\mathcal{T}_0\mathcal{T}_0\mathcal{T}_0$ and $\mathcal{T}_1\mathcal{T}_0\mathcal{T}_0$.

The simplifications of these two transducers, called \mathcal{T}_a and \mathcal{T}_b will be obtained in Section 5.1, and are depicted in Figure 5.

We then study the transducer \mathcal{T}_D formed by the two transducers \mathcal{T}_a and \mathcal{T}_b and prove that there exists a tiling by \mathcal{T}_D , and that any tiling by \mathcal{T}_D is aperiodic.

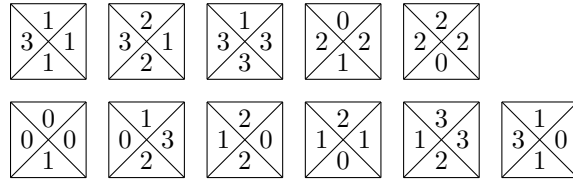
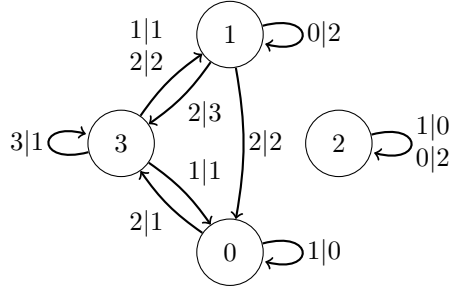

Figure 4: Wang set \mathcal{T}' , obtained from \mathcal{T} by collapsing the colors 4 and 0.

We will prove that the tileset is aperiodic, by proving that any tiling is substitutive. Let $u_{-2} = \epsilon, u_{-1} = \mathbf{a}, u_0 = \mathbf{b}, u_{n+2} = u_n u_{n-1} u_n$. For reference, here are the first values of u :

$\epsilon, \mathbf{a}, \mathbf{b}, \mathbf{aa}, \mathbf{bab}, \mathbf{aabaa}, \mathbf{babaabab}, \mathbf{aabaababaabaa}, \mathbf{babaababaabaabaabab}$

Let $g(n)$, $n \in \mathbb{N}$ be the $(n+1)$ -th Fibonacci number, that is $g(0) = 1$, $g(1) = 2$ and $g(n+2) = g(n) + g(n+1)$ for every $n \in \mathbb{N}$. Remark that u_n is of size $g(n)$. Then we will prove:

Proposition 1. *Any tiling of the plane by \mathcal{T}_D can be divided into strips of vertical width $g(n), g(n+1)$ or $g(n+2)$ so that each strip is a tiling by $\mathcal{T}_{u_n}, \mathcal{T}_{u_{n+1}}$ or $\mathcal{T}_{u_{n+2}}$.*

Remark that, by definition, $\mathcal{T}_{u_{n+3}} = \mathcal{T}_{u_{n+1}} \circ \mathcal{T}_{u_n} \circ \mathcal{T}_{u_{n+1}}$.

We will prove this by induction on n . For this, we introduce a family of transducers, presented in Figure 6, and we will prove the following:

- We show in Proposition 2 that for any tiling of the plane by \mathcal{T}_D , the words in each row avoid the factors 010 and 101.
- We prove (Section 5.2) that every tiling by $\mathcal{T}_D = \mathcal{T}_{\mathbf{a}} \cup \mathcal{T}_{\mathbf{b}}$ can be seen as a tiling by $\mathcal{T}_{u_0} \cup \mathcal{T}_{u_1} \cup \mathcal{T}_{u_2} = \mathcal{T}_{\mathbf{b}} \cup \mathcal{T}_{\mathbf{aa}} \cup \mathcal{T}_{\mathbf{bab}}$.
- We prove (Section 5.2) that for words $u, v \in W$, $u\mathcal{T}_{u_i}v \iff uT_i v$. This means that we can interchangeably replace the Wang sets $\mathcal{T}_{u_0}, \mathcal{T}_{u_1}, \mathcal{T}_{u_2}$ by T_0, T_1, T_2 without changing the tilings of the plane.
- At this point, it becomes obvious that \mathcal{T} is aperiodic if and only if the Wang set $T_0 \cup T_1 \cup T_2$ is aperiodic.

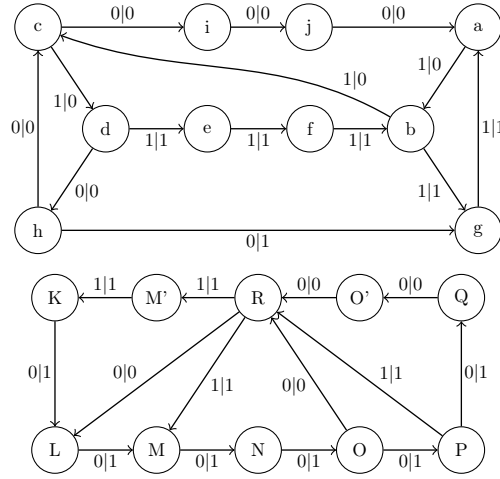

Figure 5: \mathcal{T}_D , the union of \mathcal{T}_a (top) and \mathcal{T}_b (bottom).

- We prove (Section 6) that $T_{n+3} = T_{n+1} \circ T_n \circ T_{n+1}$ for all n . As $\mathcal{T}_{u_{n+3}} = \mathcal{T}_{u_{n+1}} \circ \mathcal{T}_{u_n} \circ \mathcal{T}_{u_{n+1}}$, we obtain by an easy induction² that for all $u, v \in W$, $u\mathcal{T}_{u_n}v$ if and only if uT_nv .
- We then prove (Section 7) that any tiling by T_n, T_{n+1}, T_{n+2} can be rewritten as a tiling by $T_{n+1}, T_{n+2}, T_{n+3}$. As a consequence, any tiling by $\mathcal{T}_{u_n}, \mathcal{T}_{u_{n+1}}$ and $\mathcal{T}_{u_{n+2}}$ can be rewritten as a tiling by $\mathcal{T}_{u_{n+1}}, \mathcal{T}_{u_{n+2}}, \mathcal{T}_{u_{n+3}}$, by replacing any block $\mathcal{T}_{u_{n+1}}\mathcal{T}_{u_n}\mathcal{T}_{u_{n+1}}$ by $\mathcal{T}_{u_{n+3}}$ (the difficulty is to prove that by doing this, there is no remaining occurrence of \mathcal{T}_{u_n}).

This proves the proposition and the theorem.

Finally, we explain in Section 7 how the same proof gives us also the aperiodicity of the set \mathcal{T}' .

²To be rigorous, one also needs to use that if $r\mathcal{T}_{u_{n+1}}s\mathcal{T}_{u_n}t\mathcal{T}_{u_{n+1}}v$ with $r, v \in W$, then $s, t \in W$ which is a clear consequence of Proposition 2.

T_n for n odd:

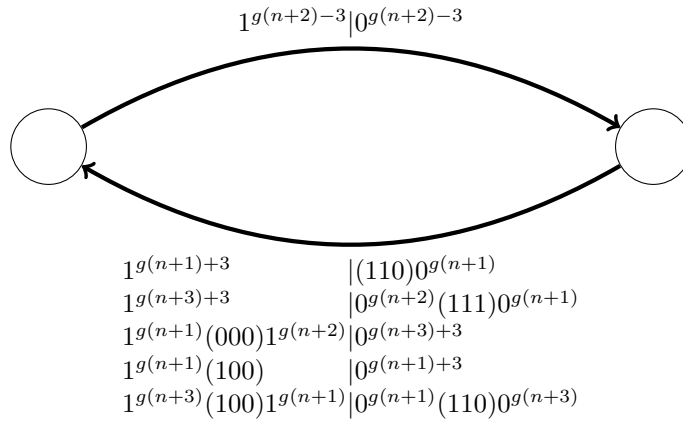

T_n for n even:

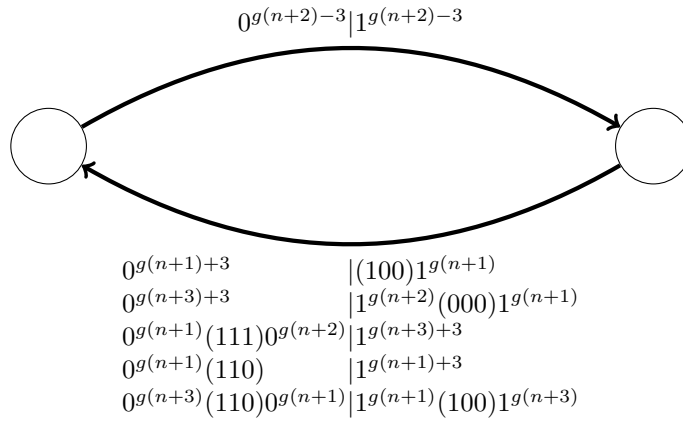

Figure 6: The family of transducers T_n

5 From \mathcal{T} to \mathcal{T}_D then to T_0, T_1, T_2

5.1 From \mathcal{T} to \mathcal{T}_D

Recall that our Wang set \mathcal{T} can be seen as the union of two Wang sets, \mathcal{T}_0 and \mathcal{T}_1 , of 9 and 2 tiles respectively.

For $w \in \{0, 1\}^* \setminus \{\epsilon\}$, let $\mathcal{T}_w = \mathcal{T}_{w[1]} \circ \mathcal{T}_{w[2]} \circ \dots \circ \mathcal{T}_{w[|w|]}$. The following facts can be easily checked by computer or by hand:

Fact 4. *The transducers $s(\mathcal{T}_{11})$, $s(\mathcal{T}_{101})$, $s(\mathcal{T}_{1001})$ and $s(\mathcal{T}_{0000})$ are empty.*

Thus, if t is a tiling by \mathcal{T} , then there exists a biinfinite binary word $w \in \{1000, 10000\}^{\mathbb{Z}}$ such that $t(x, y) \in T(\mathcal{T}_{w[y]})$ for every $x, y \in \mathbb{Z}$. Let $\mathcal{T}_A = s(\mathcal{T}_{1000} \cup \mathcal{T}_{10000})$ (see Figure 7a). There is a bijection between the tilings by \mathcal{T} and the tilings by \mathcal{T}_A , and \mathcal{T} is aperiodic if and only if \mathcal{T}_A is aperiodic.

We see that the transducer \mathcal{T}_A never reads 2, 3, nor 4. Thus the transitions that write 2, 3, or 4 are never used in a tiling by \mathcal{T} . Let \mathcal{T}_B (see Figure 7b) be the transducer \mathcal{T}_A after removing these unused transitions, and deleting states that cannot appear in a tiling of a row (i.e., sources and sinks). Then t is a tiling by \mathcal{T}_A if and only if t is a tiling by \mathcal{T}_B , and \mathcal{T}_B is aperiodic if and only if \mathcal{T}_A is.

Now we use bisimulation to slightly simplify the transducer \mathcal{T}_B . The states 23300 and 23310 have the same incoming transitions, and can therefore be coalesced into one state. The same goes for states 21300 and 21310, and for states 2300 and 2310. Once we coalesce all those states, we obtain the Wang set \mathcal{T}_C depicted in Figure 7c.

\mathcal{T}_B and \mathcal{T}_C are equivalent. Therefore, \mathcal{T}_B is aperiodic if and only if \mathcal{T}_C is aperiodic.

Proposition 2. *Let W be the set of biinfinite words which do not contain the words 010 and 101 as factors. Let u, v, w s.t. $u\mathcal{T}_C v\mathcal{T}_C w$. Then $v \in W$.*

In particular, let $(w_i)_{i \in \mathbb{Z}}$ be a biinfinite sequence of biinfinite binary words such that $w_i \mathcal{T}_C w_{i+1}$ for every $i \in \mathbb{Z}$. Then, for every $i \in \mathbb{Z}$, $w_i \in W$.

Proof. A quick inspection shows that the transducer \mathcal{T}_C does not accept as input a word which contains 101, and it does not produce a word which contains 010 as an output. \square

In a tiling by \mathcal{T}_C , the transition from Q to O is never followed by a transition from O to P, otherwise it writes a 101. Similarly, a transition from M to K is never preceded by a transition from L to M, otherwise it reads a 010. Thus, there is a bijection between tilings by \mathcal{T}_C and tilings by \mathcal{T}_D (Figure 7d).

We therefore have:

Proposition 3. *\mathcal{T} is aperiodic if and only if \mathcal{T}_D is aperiodic.*

5.2 From \mathcal{T}_D to T_0, T_1, T_2

Let \mathcal{T}_a and \mathcal{T}_b be the two connected components of \mathcal{T}_D . For a word $w \in \{a, b\}^*$, let $\mathcal{T}_w = \mathcal{T}_{w[1]} \circ \mathcal{T}_{w[2]} \circ \dots \circ \mathcal{T}_{w[|w|]}$. The following fact can be easily checked by computer or by hand:

Fact 5. *The transducers $s(\mathcal{T}_{bb})$, $s(\mathcal{T}_{aaa})$ and $s(\mathcal{T}_{babab})$ are empty.*

This implies that if t is a tiling by \mathcal{T}_C , then there exists a biinfinite binary word $w \in \{b, aa, bab\}^{\mathbb{Z}}$ such that $t(x, y) \in T(\mathcal{T}_{w[y]})$ for every $y \in \mathbb{Z}$. That is, t is an image of a tiling by $\mathcal{T}_b \cup \mathcal{T}_{aa} \cup \mathcal{T}_{bab}$.

We will now simplify the three transducers.

Case of \mathcal{T}_b . In \mathcal{T}_b , every path eventually goes to the state “N”. Thus \mathcal{T}_b is equivalent to the following transducer (written in a compact form):

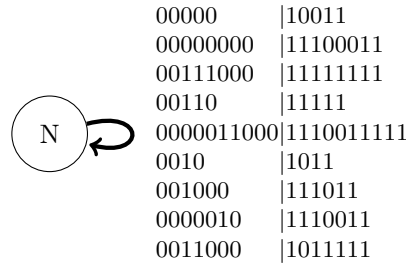

In the previous transducer, the last 4 transitions are never used in a tiling of the plane, since they read 010 or write 101. This allows us to simplify the transducer into:

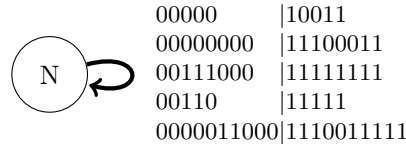

This transducer is equivalent to T_0 , that recalled here for comparison:

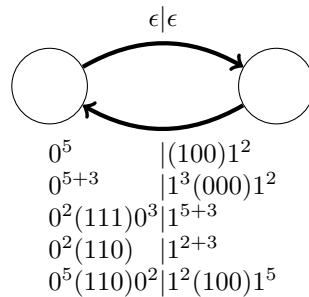

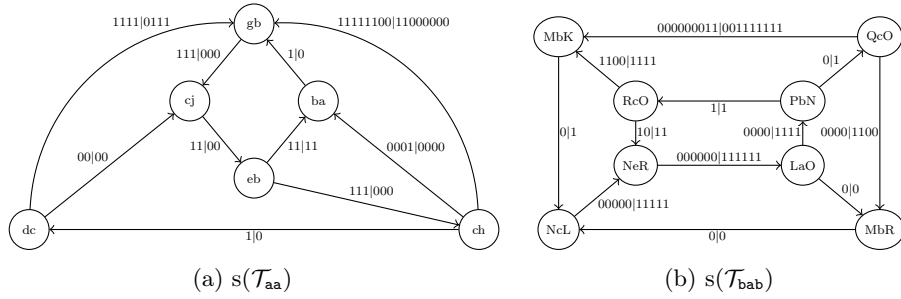
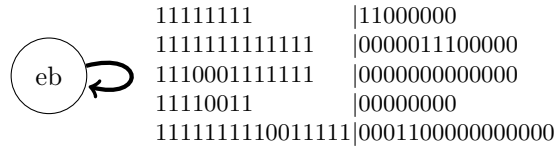
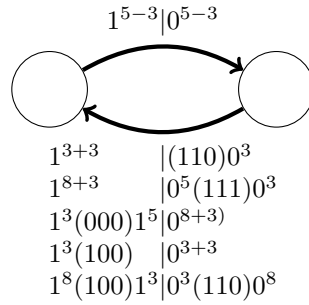

Figure 8: $s(\mathcal{T}_{aa})$ and $s(\mathcal{T}_{bab})$.

Case of \mathcal{T}_{aa} . The transducer $s(\mathcal{T}_{aa})$ is depicted in Figure 8a in a compact form. In this transducer, every path eventually goes to the state “eb”. Then $s(\mathcal{T}_{aa})$ is equivalent to the following transducer (written in a compact form):



This transducer is clearly equivalent to T_1 , recalled here for convenience:



Case of \mathcal{T}_{bab} . The transducer $s(\mathcal{T}_{\text{bab}})$ is depicted in Figure 8b.

In this transducer, every path eventually goes to the state “NeR”. Then $s(\mathcal{T}_{\text{bab}})$ is equivalent to the following transducer (written in compact form):

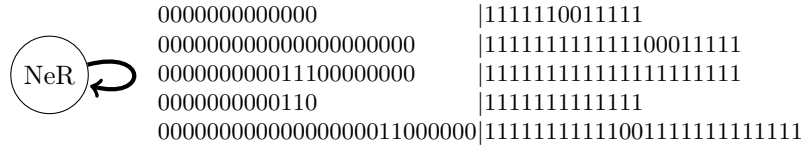

This transducer is clearly equivalent to T_2 , which we recall here for the reader’s convenience:

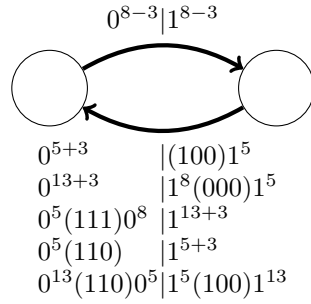

6 From T_n, T_{n+1}, T_{n+2} to $T_{n+1}, T_{n+2}, T_{n+3}$

In this section, we prove:

Theorem 4. For all words u, v we have $uT_{n+3}v \iff uT_{n+1}T_nT_{n+1}v$.

For the reader's convenience, we recall the definition of the family of transducers, and we introduce notations for the transitions.

T_n for n even:

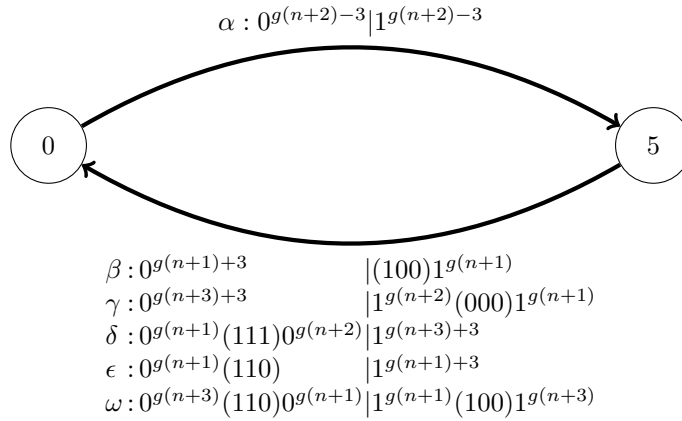

T_{n+1} for n even:

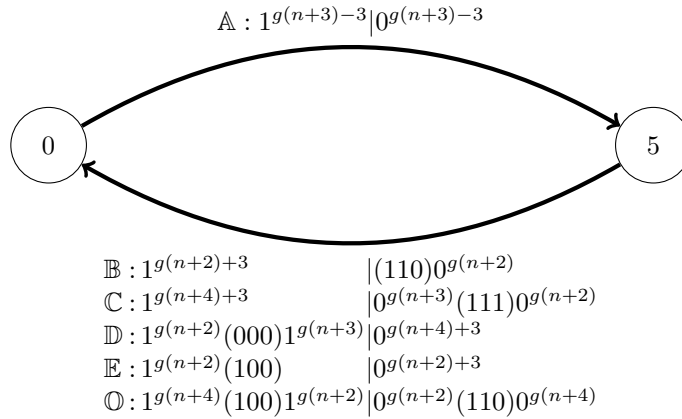

Before going through the proof, some remarks:

- T_n for n even and n odd are essentially similar. This means it is sufficient to prove the result for n even.
- Apply the following transformations to T_n : exchange input and output, reverse the direction of the edge, reverse (i.e., take the mirror) the words,

and exchange symbols 0 and 1. Then we obtain T_n again (for n even, with β playing the role of ϵ , δ the role of γ , and α and ω their own role). This internal symmetry will be used heavily in the proofs.

- All transitions are symmetric and easy to understand, except the self-symmetric tiles ω and \mathbb{O} . These transitions actually cannot occur in the tiling of the plane, but a transition of shape ω or \mathbb{O} large enough can appear in a large enough finite strip. Therefore, it is not possible to accomplish the proof without speaking about these transitions, even though they cannot appear in a tiling of the plane.

We now proceed to prove the result. As said before, we suppose that n is even, and we will look at the sequence of transducers $T_{n+1} \circ T_n \circ T_{n+1}$.

Note that the output of T_n consists essentially of long sequences of the symbol 1, and a few occurrences of 100 and 000 interspersed. We call these two words “markers”. Because the output of T_n should be fed to T_{n+1} , the distance between the markers that T_n produces should be within what T_{n+1} can read.

The following table represents the possible distance between two consecutive markers (i.e., 000 and 100) as inputs of T_{n+1} .

First Marker	Second Marker	Distance
(000) from \mathbb{D}	(000) from \mathbb{D}	$g(n+5)$
(000) from \mathbb{D}	(100) from \mathbb{E}	$g(n+5)$
(000) from \mathbb{D}	(100) from \mathbb{O}	$g(n+5)+g(n+3)$
(100) from \mathbb{E}	(000) from \mathbb{D}	$g(n+4)$
(100) from \mathbb{E}	(100) from \mathbb{E}	$g(n+4)$
(100) from \mathbb{E}	(100) from \mathbb{O}	$g(n+5)$
(100) from \mathbb{O}	(000) from \mathbb{D}	$g(n+4)+g(n+2)$
(100) from \mathbb{O}	(100) from \mathbb{E}	$g(n+4)+g(n+2)$
(100) from \mathbb{O}	(100) from \mathbb{O}	$2g(n+4)$

}

$+ag(n+4)+bg(n+5)$
 $a, b \in \mathbb{N}$

For example, between the marker 000 from \mathbb{D} and 100 from \mathbb{O} , one has 3 (the size of the first marker) plus $g(n+3)$ (the letters in \mathbb{D} after the marker), plus $g(n+3)-3$ (the letters in \mathbb{A}) plus $g(n+4)$ (the letters of \mathbb{O} before the marker). That is $3+g(n+3)+g(n+3)-3+g(n+4) = g(n+3)+g(n+5)$.

We mean by distance the absolute value between the positions of the first letter of each marker. To prove the main result, we will prove that the transitions in the transducer T_n (when surrounded by transducers T_{n+1}) must be done in a certain order.

In the following, we deliberately omit the transition α : when we say that $\gamma\beta$ cannot appear, we mean that it is impossible to see the transitions γ , followed by α and then β in a run of the transducer T_n (when surrounded by transducers T_{n+1}).

Lemma 5. *The following words cannot appear:*

- $\gamma\omega, \gamma\gamma, \gamma\beta, \beta\omega, \beta\beta, \beta\epsilon\beta, \gamma\epsilon\beta, \beta\delta\epsilon\beta, \gamma\delta\epsilon\beta$

- $\omega\delta, \delta\delta, \epsilon\delta, \omega\epsilon, \epsilon\epsilon, \epsilon\beta\epsilon, \epsilon\beta\delta, \epsilon\beta\gamma\epsilon, \epsilon\beta\gamma\delta$

Proof. All the following successions of transitions are impossible due to the input constraints on T_{n+1} :

Case	What it would produce (which cannot be fed to T_{n+1})
$\gamma\omega$	(000) and (100) separated by $g(n+1) + g(n+3)$
$\gamma\gamma$	(000) and (000) separated by $g(n+4)$
$\gamma\beta$	(000) and (100) separated by $g(n+3)$
$\beta\omega$	(100) and (100) separated by $g(n+1) + g(n+3)$
$\beta\beta$	(100) and (100) separated by $g(n+3)$
$\beta\epsilon\beta$	(100) and (100) separated by $2g(n+3)$
$\gamma\epsilon\beta$	(000) and (100) separated by $2g(n+3)$
$\beta\delta\epsilon\beta$	(100) and (100) separated by $2g(n+4) + g(n+1)$
$\gamma\delta\epsilon\beta$	(000) and (100) separated by $2g(n+4) + g(n+1)$

All other cases follow by symmetry. □

Lemma 6. ω cannot appear.

Proof. Case disjunction on what appears before:

Case	What it would produce (which cannot be fed to T_{n+1})
$\beta\omega$	see above
$\gamma\omega$	see above
$\beta\delta\omega$	(100) and (100) separated by $g(n+4) + g(n+3) + g(n+1)$
$\gamma\delta\omega$	(000) and (100) separated by $g(n+4) + g(n+3) + g(n+1)$
$\beta\epsilon\omega$	(100) and (100) separated by $g(n+4) + 2g(n+1)$
$\gamma\epsilon\omega$	(000) and (100) separated by $g(n+4) + 2g(n+1)$
$\beta\delta\epsilon\omega$	(100), (100) separated by $g(n+5) + g(n+3) + g(n+1) = 2g(n+4) + 2g(n+1)$
$\gamma\delta\epsilon\omega$	(000), (100) separated by $g(n+5) + g(n+3) + g(n+1) = 2g(n+4) + 2g(n+1)$

□

Lemma 7. \ominus cannot appear.

Proof. Suppose that \ominus appears in the top transducer (i.e., the transducers with input T_n). This means the (100) marker is generated, the only possibility being by β .

We prove there is no possibility to find transitions after this β .

Case	Why it is impossible to start from $\textcircled{0}$
$\beta\gamma$	(100) and (000) separated by $g(n+4)$
$\beta\delta\beta$	(100) and (100) separated by $g(n+4) + g(n+3)$
$\beta\delta\gamma$	(100) and (000) separated by $g(n+4) + g(n+1) + g(n+3)$
$\beta\delta\epsilon\beta$	(100) and (100) separated by $2g(n+4) + g(n+1)$
$\beta\delta\epsilon\gamma$	(100) and (000) separated by $2g(n+4) + g(n+3)$
$\beta\epsilon\gamma$	(100) and (000) separated by $g(n+5)$

By symmetry, $\textcircled{0}$ cannot appear in the bottom transducer. \square

Now that $\textcircled{0}$ has disappeared, the possible distances between the markers are greatly simplified.

First Marker	Second Marker	Distance
(000)	(000)	$g(n+5)$
(000)	(100)	$g(n+5)$
(100)	(000)	$g(n+4)$
(100)	(100)	$g(n+4)$

$\left. \begin{array}{l} +ag(n+4) + bg(n+5) \\ a, b \in \mathbb{N} \end{array} \right\}$

Lemma 8. *The following words do not appear: $\beta\epsilon$, $\epsilon\beta$, $\beta\delta\beta$, $\delta\gamma\delta$, as well as $\epsilon\gamma\epsilon$ and $\gamma\delta\gamma$*

Proof. $\beta\epsilon$ should be followed by γ which leads to (100) and (000) separated by $g(n+5)$.

$\epsilon\beta$ should be preceded by a δ , which cannot be preceded by anything.

Case	Why it is impossible
$\beta\delta\beta$	(100), (100) separated by $g(n+4) + g(n+3)$
$\gamma\delta\gamma$	(000), (000) separated by $g(n+5) + g(n+2)$

The last two follow by symmetry. \square

Lemma 9. *Every biinfinite path on the transducer T_n , when it is surrounded by transducers T_{n+1} , can be written as paths on the following graph:*

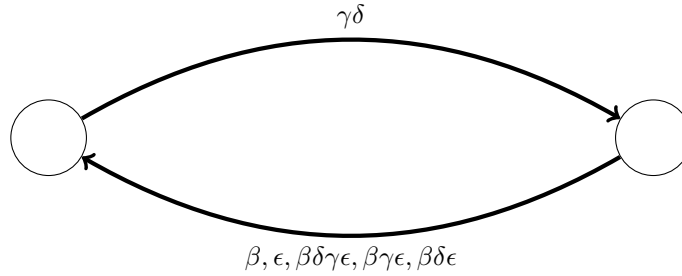

Proof. Clear: all other words are forbidden by the previous lemmas. \square

Recall that in this picture, words α have been forgotten. We now rewrite it adding the transitions α .

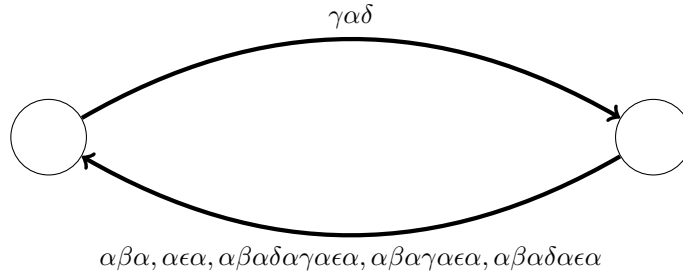

All transitions in the picture will be called meta-transitions.

We now have a more accurate description of the behavior of the transducer T_n when surrounded by transducers T_{n+1} . This will be sufficient to prove the results. We will see indeed that each of the six meta-transitions depicted can be completed in only one way by transitions of T_{n+1} . This will give us six tiles, which (almost) correspond to the transitions of T_{n+3} .

We will use drawings to prove the result. Let's first draw all tiles. The bottom corresponds to the input, and the top to the output. The colors indicate the markers: the blue (resp. black, red, green) corresponds to 111 (resp. 110, 100 and 000).

First, the transitions of T_n , seen as tiles:

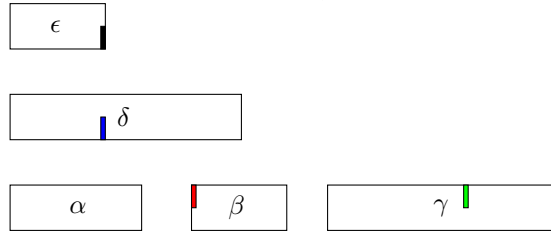

Then the transitions of T_{n+1} :

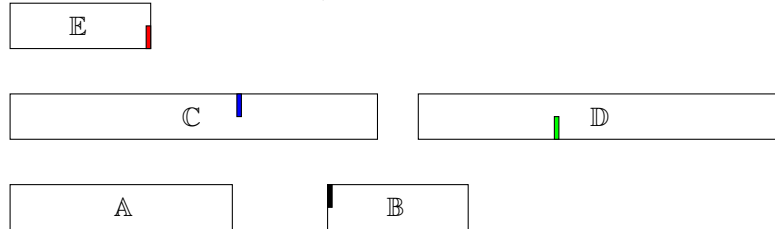

We now first look at $\gamma\delta$. By necessity, the following transitions of T_{n+1} should surround it:

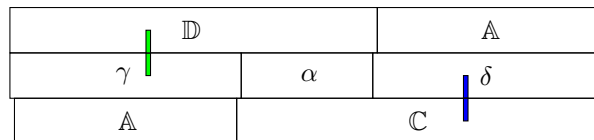

Note that the three transducers are aligned (up to a shift of ± 3) when $\gamma\alpha\delta$ is present. As all other meta-transitions are enclosed by the meta-transition $\gamma\alpha\delta$,

this means that in an execution of $T_{n+1} \circ T_n \circ T_{n+1}$, every other meta-transition should be surrounded above and below by transitions of T_{n+1} that almost align with it. Moreover, the transitions of T_{n+1} below should begin by \mathbb{A} and the transitions of T_{n+1} above should end with \mathbb{A} . It turns out that there is only one way to do this for any of the other meta-transitions.

This gives for ϵ and β :

B	A
α	ε
A	B

E	A
α	β
A	E

This gives for $\beta\gamma\epsilon$ and $\beta\delta\epsilon$:

E	A	C	A		
α	β	α	δ	α	ε
A	C	A	B		

E	A	D	A		
α	β	α	γ	α	ε
A	D	A	B		

And the piece de resistance $\beta\delta\gamma\epsilon$:

E	A	B	A	D	A		
α	β	α	δ	α	γ	α	ε
A	C	A	E	A	B		

We now look at the transducer T' we obtained with the preceding six pieces. Note that $T' = T_n \circ T_{n+1} \circ T_n \circ \sigma^3$ where σ is the shift:

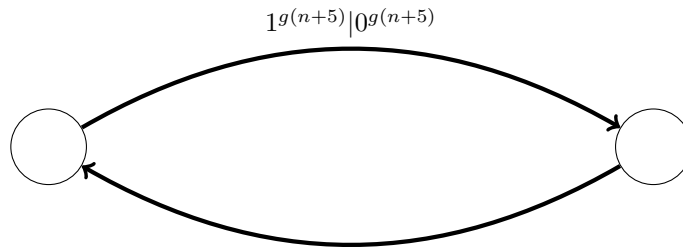

$$\begin{array}{l|l}
 1^{g(n+4)} & | (110)0^{g(n+4)-3} \\
 1^{g(n+4)-3}(100) & | 0^{g(n+4)} \\
 1^{g(n+6)} & | 0^{g(n+5)}(111)0^{g(n+4)-3} \\
 1^{g(n+4)-3}(111)1^{g(n+5)} & | 0^{g(n+6)} \\
 1^{g(n+6)-3}(100)1^{g(n+4)} & | 0^{g(n+4)}(110)0^{g(n+6)-3}
 \end{array}$$

We recognize T_{n+3} up to a shift of 3, which proves the Theorem.

7 End of the proof

7.1 Aperiodicity of \mathcal{T}

Proposition 4. *There are no words u, v s.t. $u(T_{n+1} \circ T_n \circ T_{n+1} \circ T_n \circ T_{n+1})v$*

Proof. By the previous section, T_n , when bordered by T_{n+1} on both sides, can be rewritten as concatenations of blocks of the following five types: $\beta\gamma\delta$, $\epsilon\gamma\delta$, $\beta\delta\gamma\epsilon\gamma\delta$, $\beta\gamma\epsilon\gamma\delta$ and $\beta\delta\epsilon\gamma\delta$.

However, as $T_{n+1} \circ T_n \circ T_{n+1} \circ T_n \circ T_{n+1} = T_{n+3} \circ T_n \circ T_{n+1}$, the block $\epsilon\gamma\delta$ (and any block containing it) cannot appear in the execution of the transducer T_n , as T_{n+3} does not produce any input where 100 and 000 are close enough. So the only possible block remaining is $\beta\gamma\delta$. But T_{n+3} does not produce any input where 000 and 000 are at distance $g(n+6)$. \square

Proposition 5. *Let $n \geq -2$. Any tiling of the plane by \mathcal{T}_D can be divided into strips of vertical width $g(n), g(n+1)$ or $g(n+2)$ so that each strip is a tiling by $\mathcal{T}_{u_n}, \mathcal{T}_{u_{n+1}}$ or $\mathcal{T}_{u_{n+2}}$.*

Proof of the Proposition. The proof is by induction on n . The result is trivial for $n = -2, -1$, and true for $n = 0$ by Section 5.2.

Now suppose the result holds true for n . Consider a tiling of the plane by \mathcal{T}_D . This tiling can be divided into strips that correspond to tilings by $\mathcal{T}_{u_n}, \mathcal{T}_{u_{n+1}}$ or $\mathcal{T}_{u_{n+2}}$.

By Proposition 2, the words in each row are elements of W . We can therefore replace each strip \mathcal{T}_{u_i} by T_i to obtain a tiling of the plane by $T_n \cup T_{n+1} \cup T_{n+2}$. It is easy to see, given the inputs of these transducers that, in such a tiling, each row corresponding to the transducer T_n is surrounded by rows corresponding to the transducer T_{n+1} . As a consequence, each strip corresponding to \mathcal{T}_{u_n} is surrounded by strips corresponding to $\mathcal{T}_{u_{n+1}}$.

By the previous proposition, there are no words $u, v \in W$ s.t. $u(T_{n+1} \circ T_n \circ T_{n+1} \circ T_n \circ T_{n+1})v$. As a consequence, there are no words $u, v \in W$ s.t. $u(\mathcal{T}_{u_{n+1}} \circ \mathcal{T}_{u_n} \circ \mathcal{T}_{u_{n+1}} \circ \mathcal{T}_{u_n} \circ \mathcal{T}_{u_{n+1}})v$. Therefore, in the dividing of the plane by strips, we do not have 5 consecutive strips of the words $\mathcal{T}_{u_{n+1}}, \mathcal{T}_{u_n}, \mathcal{T}_{u_{n+1}}, \mathcal{T}_{u_n}, \mathcal{T}_{u_{n+1}}$.

We can therefore replace each occurrence of 3 consecutive strips $\mathcal{T}_{u_{n+1}}, \mathcal{T}_{u_n}, \mathcal{T}_{u_{n+1}}$ by $\mathcal{T}_{u_{n+3}}$ as no occurrences overlap. After doing this, no occurrence of \mathcal{T}_{u_n} remains, which ends the proof. \square

Corollary 1. *The Wang set $\mathcal{T}_D = \mathcal{T}_a \cup \mathcal{T}_b$ is aperiodic.*

Furthermore, the set of words $u \in \{a, b\}^$, s.t. the sequence of transducers \mathcal{T}_u appears in a tiling of the plane, is exactly the set of factors of the Fibonacci word, i.e., the set of factors of sturmian words of slope $1/\phi$, for ϕ the golden mean.*

Biinfinite words $u \in \{a, b\}^{\mathbb{Z}}$, s.t \mathcal{T}_u which represents a valid tiling of the plane, are exactly the sturmian words of slope $1/\phi$.

See [BS02] for some references on sturmian words.

Proof. First, note that, for all n , the transducer T_n contains a biinfinite path. In particular, there exists $u, v \in W$ s.t. uT_nv and therefore s.t. $u\mathcal{T}_{u_n}v$. We have then, for all n , a tiling of $g(n)$ consecutive rows by \mathcal{T}_D . By compactness, there exists a tiling of the plane by \mathcal{T}_D .

Now consider any tiling by τ_D . Let v be the word over the alphabet $\{\mathbf{a}, \mathbf{b}\}$ s.t. $v_i = \mathbf{a}$ if the i -th row of the tiling corresponds to $\mathcal{T}_{\mathbf{a}}$ and $v_i = \mathbf{b}$ otherwise.

By the previous proposition, any tiling by τ_D can be decomposed into tilings by $\tau_{u_n}, \tau_{u_{n+1}}, \tau_{u_{n+2}}$ for all n , which implies that the word v can be written as a concatenation of u_n, u_{n+1} and u_{n+2} .

The sequence of words u_n we defined is the sequence of singular factors of the Fibonacci word (see for example [WW94]). Thus, v has the same set of factors as the Fibonacci word. In particular, v is not periodic. \square

Corollary 2. *The Wang set \mathcal{T} is aperiodic. Furthermore, the set of words $u \in \{0, 1\}^*$ s.t. the sequence of transducers \mathcal{T}_u appears in a tiling of the plane is exactly the set of factors of sturmian words of slope $1/(\phi + 2)$, for ϕ the golden mean.*

The set of biinfinite words $u \in \{0, 1\}^{\mathbb{Z}}$ s.t. \mathcal{T}_u which represents a valid tiling of the plane are exactly the sturmian words of slope $1/(\phi + 2)$.

Proof. Let ψ be the morphism $\mathbf{a} \mapsto 10000, \mathbf{b} \mapsto 1000$. The set of all words $u \in \{0, 1\}^{\mathbb{Z}}$ that can appear in a tiling of the whole plane are exactly the image by ψ of the sturmian words over the alphabet $\{a, b\}$ of slope $1/\phi$.

It is well known that the image of a sturmian word by ψ is again a sturmian word, see [BS02, Corollary 2.2.19], where $\psi = \tilde{G}^3 D$ (with $\{a, b\}$ instead of $\{0, 1\}$ as input alphabet). The derivation of the slope is routine. \square

7.2 Aperiodicity of \mathcal{T}'

Recall that \mathcal{T}' is the Wang set from Figure 4. This Wang set is obtained from \mathcal{T} , by merging two vertical colors: 0 and 4 in \mathcal{T} become 0 in \mathcal{T}' . Thus, every tiling of \mathcal{T} can be turned into a tiling of \mathcal{T}' , and therefore \mathcal{T}' tiles the plane. We will show below that every tiling of \mathcal{T}' can be turned into a tiling of \mathcal{T} , and thus every tiling of \mathcal{T}' is aperiodic.

\mathcal{T}' is the union of two Wang sets \mathcal{T}'_0 and \mathcal{T}'_1 of respectively 9 and 2 tiles. The following facts can be easily checked by computer. For $w \in \{0, 1\}^* \setminus \{\epsilon\}$, let $\mathcal{T}'_w = \mathcal{T}'_{w[1]} \circ \mathcal{T}'_{w[2]} \circ \dots \circ \mathcal{T}'_{w[|w|]}$.

Fact 6. *The transducers $s(\mathcal{T}'_{111}), s(\mathcal{T}'_{101}), s(\mathcal{T}'_{1001}), s(\mathcal{T}'_{1000001}), s(\mathcal{T}'_{10000001}), s(\mathcal{T}'_{100000001}), s(\mathcal{T}'_{000000000}), s(\mathcal{T}'_{000011}), s(\mathcal{T}'_{110000})$ and $s(\mathcal{T}'_{1100011})$ are empty.*

Thus, if t is a tiling by \mathcal{T}' , then there exists a biinfinite binary word $w \in \{1000, 10000, 100011000, 100000000\}^{\mathbb{Z}}$ such that $t(x, y) \in T(\mathcal{T}'_{w[y]})$ for every $x, y \in \mathbb{Z}$.

Let $\mathcal{T}'_A = s(\mathcal{T}'_{1000} \cup \mathcal{T}'_{10000} \cup \mathcal{T}'_{100000000} \cup \mathcal{T}'_{100011000})$. As before, \mathcal{T}'_A has unused transitions (those which write 2 or 3). Once deleted, and then once having deleted states which cannot appear in a tiling of a row, we obtain \mathcal{T}'_B . \mathcal{T}'_B has

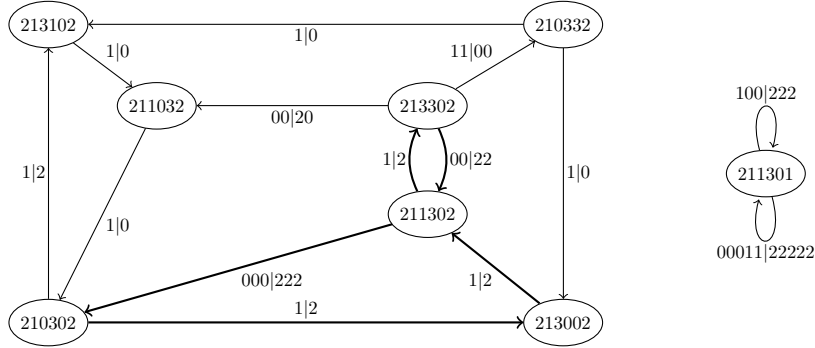

Figure 9: \mathcal{T}'_{100001} (left) and \mathcal{T}'_{100000} (right).

4 connected components: two were already present in \mathcal{T} : \mathcal{T}_a and \mathcal{T}_b , the third one \mathcal{T}_c is a subset of $\mathcal{T}'_{100000000}$, and the last one \mathcal{T}_d is a subset of $\mathcal{T}'_{100011000}$.

Proposition 6. \mathcal{T}'_{11} is isomorphic to a subset of \mathcal{T}'_{01} , and \mathcal{T}'_{100000} is isomorphic to a subset of \mathcal{T}'_{100001} .

Proof. \mathcal{T}'_{11} is the transducer with one state, which reads 1 and writes 2. \mathcal{T}'_{01} also has a loop that reads 1 and writes 2: the transition $(02, 02, 1, 2)$. \mathcal{T}'_{100000} and \mathcal{T}'_{100001} are depicted in Figure 9 (in a compact form). \mathcal{T}'_{100000} is isomorphic to the subset of \mathcal{T}'_{100001} drawn in bold. \square

Corollary 3. \mathcal{T}_c and \mathcal{T}_d are both isomorphic to a subset of $\mathcal{T}_a \circ \mathcal{T}_b$.

A tiling of \mathcal{T}'_B can thus be turned into a tiling of \mathcal{T}_B , by substituting every tile from \mathcal{T}_c (resp. \mathcal{T}_d) by two tiles, one from \mathcal{T}_a and one from \mathcal{T}_b .

Theorem 5. The Wang set \mathcal{T}' is aperiodic.

Proof. The Wang set \mathcal{T}' is aperiodic if and only if \mathcal{T}'_B is aperiodic. Suppose that \mathcal{T}'_B is not aperiodic. We know that \mathcal{T}' , and thus \mathcal{T}'_B tile the plane. Take a periodic tiling by \mathcal{T}'_B . This tiling can be turned into a tiling of \mathcal{T}_B by the Corollary 3. Thus \mathcal{T}_B has a periodic tiling, contradiction. \square

7.3 A third aperiodic set \mathcal{T}''

During our research, we also find a third aperiodic set \mathcal{T}'' of 11 Wang tiles (Figure 10). As for the two others, \mathcal{T}'' is the union of two Wang sets, \mathcal{T}''_0 and \mathcal{T}''_1 , of respectively 9 and 2 tiles. For $w \in \{0, 1\}^* \setminus \{\epsilon\}$, let $\mathcal{T}''_w = \mathcal{T}''_{w[1]} \circ \mathcal{T}''_{w[2]} \circ \dots \circ \mathcal{T}''_{w[|w|]}$.

Fact 7. The transducers $s(\mathcal{T}''_{11})$, $s(\mathcal{T}''_{101})$, $s(\mathcal{T}''_{1001})$ and $s(\mathcal{T}''_{00000})$ are empty. Therefore, if t is a tiling by \mathcal{T}'' , there exists a biinfinite binary word $w \in \{1000, 10000\}^{\mathbb{Z}}$ such that $t(x, y) \in T(\mathcal{T}''_{w[y]})$ for every $x, y \in \mathbb{Z}$.

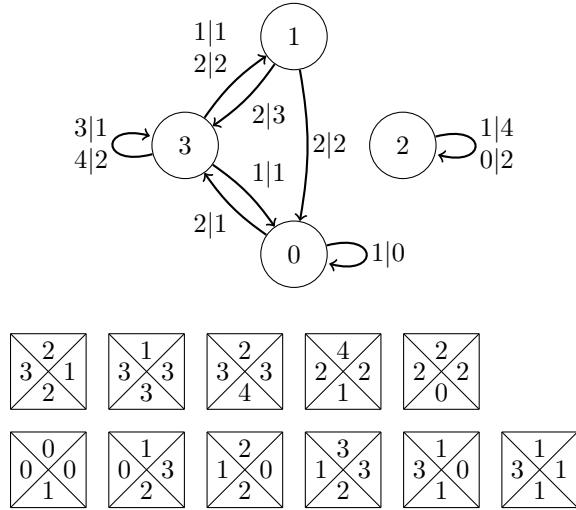

Figure 10: The aperiodic Wang set \mathcal{T}'' .

\mathcal{T}''_{1000} (resp. \mathcal{T}''_{10000}) does not act exactly as \mathcal{T}_{1000} (resp. \mathcal{T}_{10000}). However, if we compose them with the shift transducer \mathcal{S} (Figure 11), we get transducers equivalent to \mathcal{T}_C . Let $\mathcal{T}'_A = s((\mathcal{T}''_{1000} \cup \mathcal{T}''_{10000}) \circ \mathcal{S})$. It is easy to see that the composition with \mathcal{S} does not change the aperiodic status. \mathcal{T}'_A never reads 2, 3 nor 4. Thus the transitions that write 2, 3 or 4 are never used in a tiling by \mathcal{T}'_A . Let \mathcal{T}''_B (Figure 12a) be the transducer \mathcal{T}'_A after removing these unused transitions, and deleting states that cannot appear in a tiling of a row (i.e., sources and sinks). Some states are bisimilar in \mathcal{T}''_B . If we contract these states, we got \mathcal{T}''_C (Figure 12b), which is isomorphic to \mathcal{T}_C . Thus \mathcal{T}'' is aperiodic.

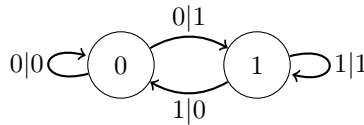
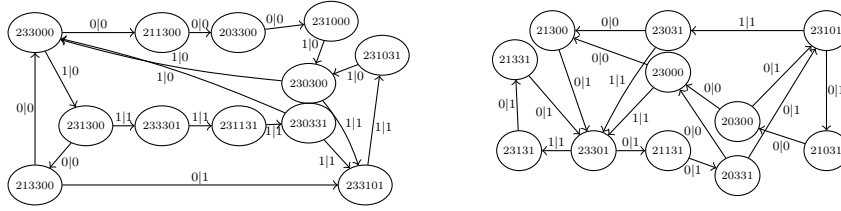

Figure 11: The shift transducer \mathcal{S} .

7.4 Remarks

The reader may regret that our substitutive system starts from $\mathcal{T}_b \cup \mathcal{T}_{aa} \cup \mathcal{T}_{bab}$ and not from $\mathcal{T}_a \cup \mathcal{T}_b \cup \mathcal{T}_{aa}$, or even from $\mathcal{T}_a \cup \mathcal{T}_b$. We do not know if this is possible. Our definition of \mathcal{T}_n certainly does not work for $n = -1$, and the natural generalization of it is not equivalent to \mathcal{T}_a . This is somewhat obvious, as \mathcal{T}_n (for $n \geq 0$) cannot be composed with itself, whereas \mathcal{T}_a should be composed with itself to obtain \mathcal{T}_{aa} .



(a) Wang set \mathcal{T}_B'' .

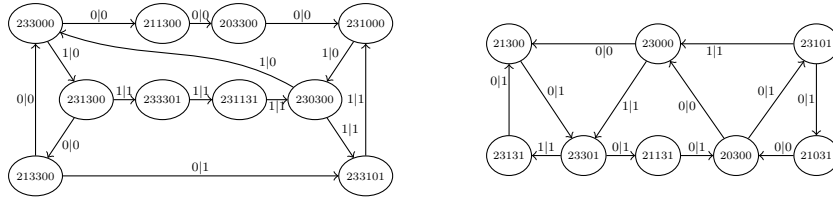

(b) Wang set \mathcal{T}_C'' , the simplification of \mathcal{T}_B'' by bisimulation.

\mathcal{T}_a and \mathcal{T}_b both have the property of being time symmetric: if we reverse the directions of all edges, exchange inputs and outputs, and exchange 0 and 1, we obtain an equivalent transducer (it is obvious for \mathcal{T}_b and becomes obvious for \mathcal{T}_a if we write it in a compact form without the states h and g). This property was used to simplify the proof that the sequence (T_n) is a recursive sequence, but we do not know whether it can be used to simplify the entire proof.

While we gave a sequence of transducers T_n , it is, of course, possible to give another sequence of transducers, say U_n , which are equivalent to T_n , and have therefore the same properties. Our sequence T_n has nice properties, in particular the symmetry explained above and its short number of transitions, but it has the drawback that the substitution, once seen geometrically, has small bumps due to the fact that the tiles are aligned only up to ± 3 . It is possible to find a sequence U_n for which this does not appear, by splitting some transitions of T_n into transitions of size $g(k)$ and transitions of size exactly 3. However, this complicates the proof that the sequence is recursive. We think our sequence T_n reaches an acceptable compromise.

We do not know whether it is possible to obtain the result directly on the original tiling \mathcal{T} rather than \mathcal{T}_D . A difficulty for this approach would be that \mathcal{T} is not purely substitutive (due in part to the fact that no Sturmian word of slope $1/(\phi + 2)$ is purely morphic). At best, we could obtain that tilings by \mathcal{T} are images by some map ϕ of some substitutive tilings (which is more or less what we obtain in our proof).

8 Conclusion

We have shown that there is an aperiodic set of 11 Wang tiles, and that it is the smallest possible. Moreover, the set uses only 4 colors, and this is also the minimum possible among all aperiodic Wang sets.

During our research, we also obtained a large number of Wang sets with 11 tiles which are candidates for aperiodicity. These candidates are available on the repository. The reader might ask why we choose to investigate this particular set, \mathcal{T} . The reason is that it is very easy for a computer to produce the transducer for \mathcal{T}^k , even for large values of k ($k \sim 1000$). In contrast, for almost all other tilesets, we were not able to reach even $k = 30$. This suggested this tileset had some particular structure. We will not give here more details on all our candidates, but we will say that a large number of them are tilesets corresponding to Kari's method, with one or more tiles omitted. With the method we described, we were able to prove that some of them do not tile the plane, but the method did not work on all of them. For now, we have found only three tilesets: the ones presented in this article, which were likely to be substitutive or nearly substitutive.

Experimental results tend to support the following conjecture

Conjecture 2. *Let $f(n)$ be the smallest k s.t. every Wang set of size n that does not tile the plane does not tile a square of size k . Let $g(n)$ be the smallest k s.t. every Wang set of size n that tiles the plane periodically does so with a period $p \leq k$.*

Then $g(n) \leq f(n)$ for all n .

Acknowledgements

We gratefully acknowledge support from the PSMN (Pôle Scientifique de Modélisation Numérique) of the ENS de Lyon for the computing resources. We also thank Jorge Pereda and anonymous reviewers for their careful reading of the manuscript and for their comments.

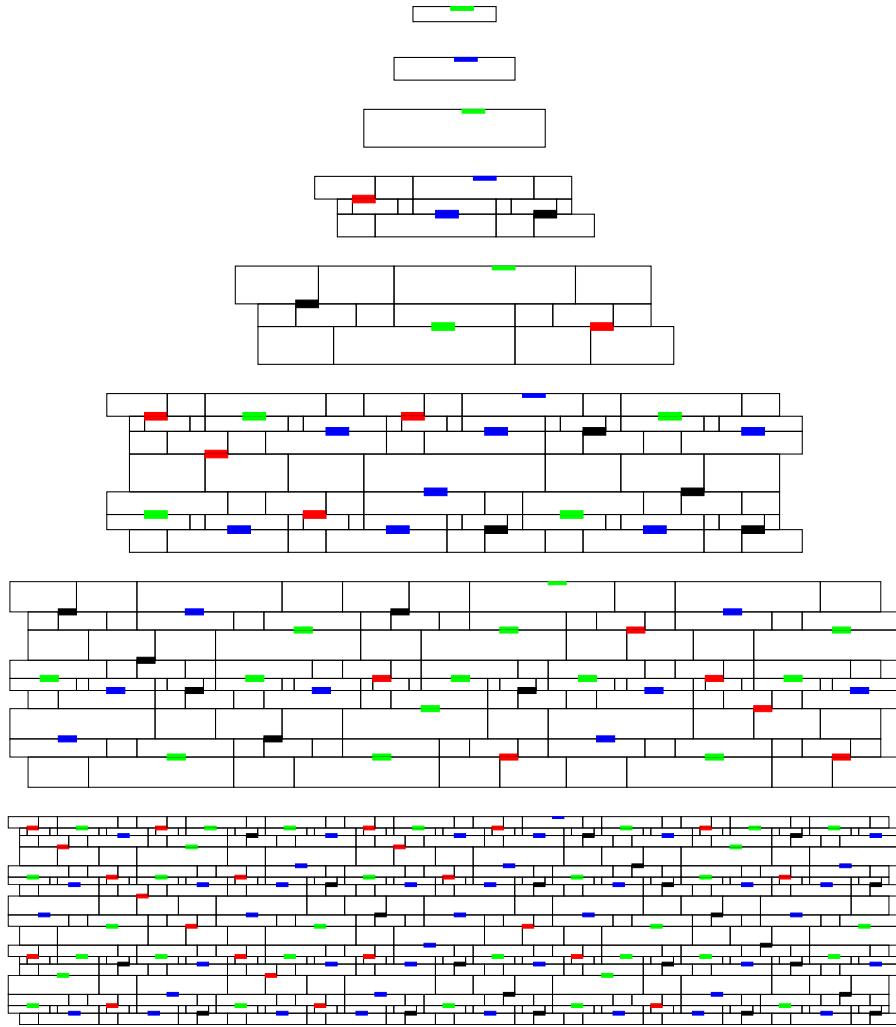

Figure 13: Representation of the meta-tile γ (resp. C if n is odd) of T_n as tiles of $T_0 \uplus T_1 \uplus T_2$ for $n = 0, 1, 2, 3, 4, 5, 6, 7$.

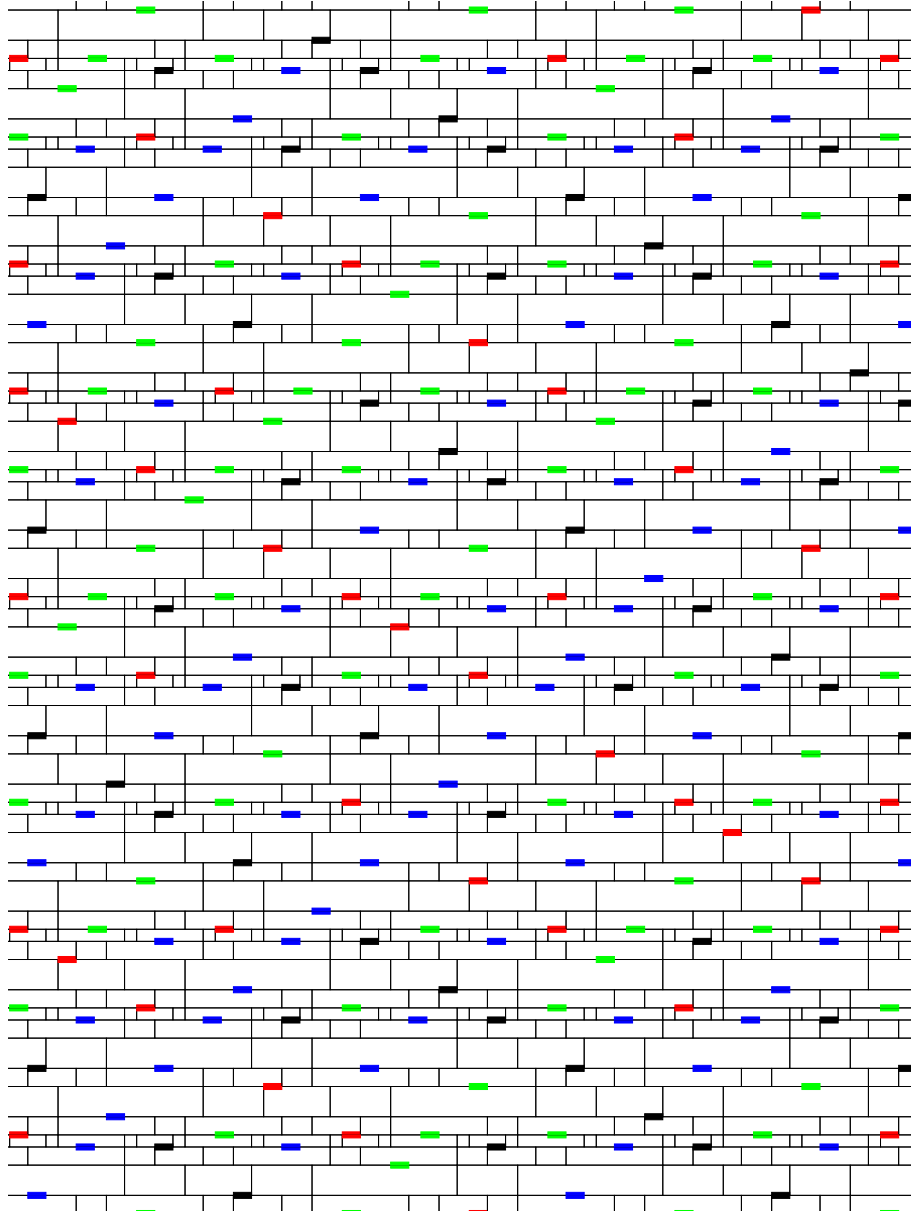

Figure 14: A fragment of a tiling by the transducers T_0, T_1, T_2 .

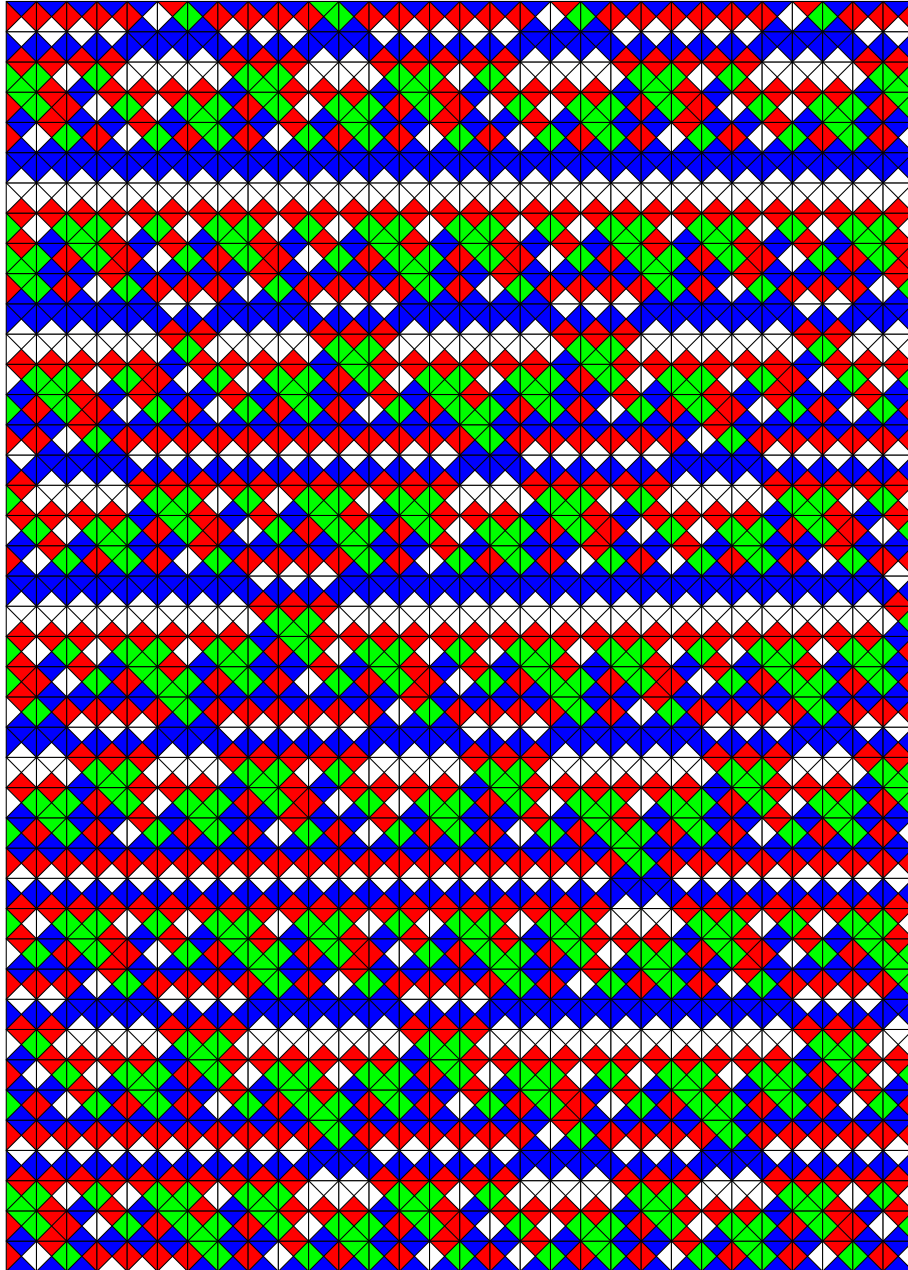

Figure 15: A fragment of a tiling by \mathcal{T}' , with $(0,1,2,3)=(\text{white},\text{red},\text{blue},\text{green})$.

References

- [AD01] Cyril Allauzen and Bruno Durand. Tiling Problems. In The Classical Decision Problem, Perspectives in Mathematical Logic, chapter A, pages 407–420. Springer, 2001.
- [AL74] Stål Olav Aanderaa and Harry R. Lewis. Linear Sampling and the $\forall\exists\forall$ Case of the Decision Problem. Journal of Symbolic Logic, 39(3):519–548, September 1974. See also [Lew79].
- [Ber64] Robert Berger. The Undecidability of the Domino Problem. PhD thesis, Harvard University, 1964.
- [Ber66] Robert Berger. The Undecidability of the Domino Problem. Number 66 in Memoirs of the American Mathematical Society. The American Mathematical Society, 1966.
- [BS02] Jean Berstel and Patrice Séébold. Sturmian Words. In Algebraic Combinatorics on Words, chapter 2, pages 40–97. Cambridge University Press, 2002.
- [Céc17] Gérard Cécé. Foundation for a series of efficient simulation algorithms. 2017 32nd Annual ACM/IEEE Symposium on Logic in Computer Science (LICS), pages 1–12, 2017.
- [CHLL14] Hung-Hsun Chen, Wen-Guei Hu, De-Jan Lai, and Song-Sun Lin. Nonemptiness problems of Wang tiles with three colors. Theoretical Computer Science, 547:34–45, August 2014.
- [Cul96] Karel Culik II. An aperiodic set of 13 Wang tiles. Discrete Mathematics, 160:245–251, 1996.
- [DLS04] Bruno Durand, Leonid A. Levin, and Alexander Shen. Local rules and global order, or aperiodic tilings. Mathematical Intelligencer, 27(1):64–68, 2004.
- [DRS12] Bruno Durand, Andrei Romashchenko, and Alexander Shen. Fixed-point tile sets and their applications. Journal of Computer and System Sciences, 78(3):731–764, May 2012.
- [DSR08] Bruno Durand, Alexander Shen, and Andrei Romashchenko. Fixed Point and Aperiodic Tilings. Technical Report TR08-030, ECCC, 2008.
- [FO10] Thomas Fernique and Nicolas Ollinger. Combinatorial Substitutions and Sofic Tilings. In Journées Automates Cellulaires (JAC), TUCS, pages 100–110, 2010.
- [GJS12] Franz Gähler, Antoine Julien, and Jean Savinien. Combinatorics and Topology of the Robinson tiling. Comptes Rendus de l’Académie des Sciences de Paris, Série I - Mathématiques, pages 627–631, 2012.

- [GS87] Branko Grunbaum and G.C. Shephard. Tilings and Patterns. W.H. Freeman, 1987.
- [GS98] Chaim Goodman-Strauss. Matching Rules and Substitution Tilings. Annals of Mathematics, 147(1):181–223, 1998.
- [Her70] Hans Hermes. Entscheidungsproblem und Dominospiele. In Selecta Mathematica II. Springer, 1970.
- [Her71] Hans Hermes. A simplified proof for the unsolvability of the decision problem in the case $\wedge \vee \wedge$. In Logic Colloquium 1969, volume 61 of Studies in Logic and the Foundations of Mathematics, pages 307–310, 1971.
- [Hop71] John E. Hopcroft. An $n \log n$ algorithm for minimizing states in a finite automaton. Technical Report STAN-CS-71-190, Stanford university, computer science department, January 1971.
- [JM97] Aimee Johnson and Kathleen Madden. Putting the Pieces Together: Understanding Robinson’s Nonperiodic Tilings. The College Mathematics Journal, 28(3):172–181, May 1997.
- [JR12] Emmanuel Jeandel and Nicolas Rolin. Fixed Parameter Undecidability for Wang Tilesets. In Symposium on Cellular Automata (JAC), pages 69–85, 2012.
- [JR19] Emmanuel Jeandel and Michaël Rao. <https://framagit.org/mrao/small-wang-tile-sets>, 2019.
- [Kar92] Jarkko Kari. The Nilpotency Problem of One-Dimensional Cellular Automata. SIAM Journal on Computing, 21(3):571–586, 1992.
- [Kar96] Jarkko Kari. A small aperiodic set of Wang tiles. Discrete Mathematics, 160:259–264, 1996.
- [KMW62] A.S. Kahr, Edward F. Moore, and Hao Wang. Entscheidungsproblem reduced to the $\forall \exists \forall$ case. Proceedings of the National Academy of Sciences of the United States of America, 48(3):365–377, March 1962.
- [Knu68] Donald E. Knuth. Fundamental Algorithms, volume 1 of The Art of Computer Programming, section 2.3.4.3 The infinity lemma, pages 382–385. Addison-Wesley, first edition, 1968.
- [KP99] Jarkko Kari and P. Papasoglu. Deterministic Aperiodic Tile Sets. Geometric And Functional Analysis, 9:353–369, 1999.
- [KS90] Paris C. Kanellakis and Scott A. Smolka. CCS Expressions, Finite State Processes and Three Problems of Equivalence. Information and Computation, 86:43–68, 1990.

- [Lev05] Leonid A. Levin. Aperiodic Tilings: Breaking Translational Symmetry. The Computer Journal, 48(6):642–645, 2005.
- [Lew79] Harry R. Lewis. Unsolvable Classes of Quantificational Formulas. Addison-Wesley, 1979.
- [lGO12] Bastien le Gloanec and Nicolas Ollinger. Substitutions and Strongly Deterministic Tilesets. In Computability in Europe (CiE), number 7318 in Lecture Notes in Computer Science, pages 462–471. Springer, 2012.
- [Luc03] Lucian Ilie and Sheng Yu. Reducing nfcs by invariant equivalences. Theoretical Computer Science, 306:373–390, 2003.
- [Luk09] Ville Lukkarila. The 4-way deterministic tiling problem is undecidable. Theoretical Computer Science, 410:1516–1533, 2009.
- [Moz89] Shahar Mozes. Tilings, substitutions systems and dynamical systems generated by them. J. d’Analyse Math., 53:139–186, 1989.
- [MS72] A. R. Meyer and L. J. Stockmeyer. The equivalence problem for regular expressions with squaring requires exponential space. In 13th Annual Symposium on Switching and Automata Theory (swat 1972), pages 125–129, 1972.
- [Oll08] Nicolas Ollinger. Two-by-Two Substitution Systems and the Undecidability of the Domino Problem. In CiE 2008, number 5028 in Lecture Notes in Computer Science, pages 476–485, 2008.
- [Poi80] Bruno Poizat. Une théorie finiment axiomatisable et superstable. Groupe d’études de théories stables, 3:1–9, 1980.
- [Pou10] Victor Poupet. Yet Another Aperiodic Tile Set . In Journées Automates Cellulaires (JAC), TUCS, pages 191–202, 2010.
- [PT87] Robert Paige and Robert E. Tarjan. Three Partition Refinement Algorithms. SIAM Journal on Computing, 16(6):973–989, December 1987.
- [Rob67] RM Robinson. Seven polygons which permit only nonperiodic tilings of the plane. Notices Amer. Math. Soc., 14:835, 1967.
- [Rob71] Raphael M. Robinson. Undecidability and Nonperiodicity for Tilings of the Plane. Inventiones Mathematicae, 12(3):177–209, 1971.
- [Sal89] Olivier Salon. Quelles tuiles! (Pavages aperiodiques du plan et automates bidimensionnels). Journal de Théorie des Nombres de Bordeaux, 1(1):1–26, 1989.
- [Sen95] Marjorie Senechal. Quasicrystals and geometry. Cambridge University Press, 1995.

- [Val10] Antti Valmari. Simple Bisimilarity Minimization in $O(m \log n)$ Time. Fundamenta Informaticae, 105:319–339, 2010.
- [Wan61] Hao Wang. Proving theorems by Pattern Recognition II. Bell Systems technical journal, 40:1–41, 1961.
- [Wan75] Hao Wang. Notes on a class of tiling problems. Fundamenta Mathematicae, 82:295–305, 1975.
- [WW94] Zhi-Xiong Wen and Zhi-Ying Wen. Some Properties of the Singular Words of the Fibonacci Word. European Journal of Combinatorics, 15(6):587–598, November 1994.