



HAL
open science

An aperiodic set of 11 Wang tiles

Emmanuel Jeandel, Michael Rao

► **To cite this version:**

| Emmanuel Jeandel, Michael Rao. An aperiodic set of 11 Wang tiles. 2015. hal-01166053v2

HAL Id: hal-01166053

<https://inria.hal.science/hal-01166053v2>

Preprint submitted on 22 Jun 2015 (v2), last revised 21 Nov 2021 (v4)

HAL is a multi-disciplinary open access archive for the deposit and dissemination of scientific research documents, whether they are published or not. The documents may come from teaching and research institutions in France or abroad, or from public or private research centers.

L'archive ouverte pluridisciplinaire **HAL**, est destinée au dépôt et à la diffusion de documents scientifiques de niveau recherche, publiés ou non, émanant des établissements d'enseignement et de recherche français ou étrangers, des laboratoires publics ou privés.

An aperiodic set of 11 Wang tiles

Emmanuel Jeandel and Michael Rao

June 22, 2015

Abstract

A new aperiodic tile set containing 11 Wang tiles on 4 colors is presented. This tile set is minimal in the sense that no Wang set with less than 11 tiles is aperiodic, and no Wang set with less than 4 colors is aperiodic.

Wang tiles are square tiles with colored edges. A tiling of the plane by Wang tiles consists in putting a Wang tile in each cell of the grid \mathbb{Z}^2 so that contiguous edges share the same color. The formalism of Wang tiles was introduced by Wang [Wan61] to study decision procedures for a specific fragment of logic (see section 1.1 for details).

Wang asked the question of the existence of an aperiodic tile set: A set of Wang tiles which tiles the plane but cannot do so periodically. His student Berger quickly gave an example of such a tile set, with a tremendous number of tiles. The number of tiles needed for an aperiodic tileset was reduced during the years, first by Berger himself, then by others, to obtain in 1996 the previous record of an aperiodic set of 13 Wang tiles. (see section 1.2 for an overview of previous aperiodic sets of Wang tiles).

While reducing the number of tiles may seem like a tedious exercise in itself, the articles also introduced different techniques to build aperiodic tilesets, and different techniques to prove aperiodicity.

A few lower bounds exist on the number of Wang tiles needed to obtain an aperiodic tile set, the only reference [GS87] citing the impossibility to have one with 4 tiles or less. On the other hand, recent results show that an aperiodic set of Wang tiles need to have at least 4 different colors [CHLL14].

In this article, we fill all the gaps: We prove that there are no aperiodic tile set with less than 11 Wang tiles, and that there is an aperiodic tile set with 11 Wang tiles and 4 colors.

The discovery of this tile set, and the proof that there is no aperiodic tile set with a smaller number of tiles was done by a computer search: We generated in particular all possible candidates with 10 tiles or less, and prove they were not aperiodic. Surprisingly it was somewhat easy to do so for all of them except one. The situation is different for 11 tiles: While we have found an aperiodic tileset, we also have a short list of tile set for which we do not know anything. The description of this computer search is described in section 3 of the paper, and

can possibly be skipped by a reader only interested in the tile set itself. This section also contains a result of independent interest: the tile set from Culik with one tile omitted does not tile the plane.

The tile set itself is presented in section 4, and the remaining sections prove that it is indeed an aperiodic tiling.

1 Aperiodic sets of Wang tiles

Here is a brief summary of the known aperiodic sets of Wang tiles. Explanations about some of them may be found in [GS87]. We stay clear in this history about aperiodic sets of geometric figures, and focus only on Wang tiles.

1.1 Wang tiles and the $\forall\exists\forall$ problem

Wang tiles were introduced by Wang [Wan61] in 1961 to study the decidability of the $\forall\exists\forall$ fragment of first order logic. Wang showed in this article how to build, starting from a $\forall\exists\forall$ formula ϕ , a set of tiles τ and a subset $\tau' \subseteq \tau$ so that there exists a tiling by τ of the upper quadrant with tiles in the first row in τ' iff ϕ is satisfiable. If this particular tiling problem was decidable, this would imply that the satisfiability of $\forall\exists\forall$ formulas was decidable.

Wang asked more generally in this article whether the more general tiling problem (with no particular tiles in the first row) is decidable and gave the *fundamental conjecture*: Every tiling either admits a periodic tiling or does not tile.

Regardless of the status of this particular conjecture, Kahr, Moore and Wang [KMW62] proved the next year that the $\forall\exists\forall$ problem is indeed undecidable by reducing to another tiling problem: now we fix a subset τ' of tiles so that every tile on the diagonal of the first quadrant is in τ' . This proof was later simplified by Hermes [Her71, Her70]. From the point of view of first order logic, the problem is thus solved. Formally speaking, the tiling problem with a constraint diagonal is reduced to a formula of the form $\forall x\exists y\forall z\phi(x, y, z)$ where ϕ contains a binary predicate P and some occurrences of the subformula $P(x, x)$ (to code the diagonal constraint). If we look at $\forall\exists\forall$ formulas that do not contain the subformula $P(x, x)$ and $P(z, z)$, the decidability of this particular fragment remained open.

A few years later, Berger proved however [Ber64] that the domino problem is undecidable, and that an aperiodic tiling existed. This implies in particular that the particular fragment of $\forall x\exists y\forall z$ where the only occurrences of the binary predicates P are of the form $P(x, z), P(y, z), P(z, y), P(z, x)$ was undecidable.

A few other subcases of $\forall\exists\forall$ were done over the years. In 1975, Aanderaa and Lewis [AL74] proved the undecidability of the fragment of $\forall\exists\forall$ where the binary predicates P can only appear in the form $P(x, z)$ and $P(z, y)$. It has in particular the following consequence: The domino problem for *deterministic* tilings is undecidable

1.2 Aperiodic tilesets

The first example of a set of Wang tiles was provided by Berger in 1964. The set contained in the 1966 AMS publication [Ber66] contains 20426 tiles, but Berger's original PhD Thesis [Ber64] also contains a simplified version with 104 tiles. This tileset is of a substitutive nature. Knuth [Knu68] gave another simplified version of Berger's original proof with 92 tiles.

Lauchli obtained in 1966 an aperiodic set of 40 Wang tiles, published in 1975 in a paper of Wang [Wan75].

Robinson found in 1967 an aperiodic set of 52 tiles. It was mentioned in a Notices of the AMS summary, but the only place this set can be found is in an article of Poizat [Poi80]. His most well known tileset is however a 1969 tileset (published in 1971) [Rob71] of 56 tiles. The paper hints at a set of 35 Wang tiles.

Robinson managed to lower the number of tiles again to 32 using a idea due to Roger Penrose. The same idea is used by Grunbaum and Shephard to obtain an aperiodic set of 24 tiles [GS87]. Robinson obtained in 1977 a set of 24 tiles from a tiling method by Ammann. The record for a long time was held by Ammann, who obtained in 1978 a set of 16 Wang tiles. Details on these tilesets are provided when available in [GS87].

In 1975, Aanderaa and Lewis [AL74] build the first aperiodic *deterministic* tileset. No details about the tileset are provided but it is possible to extract one from the exposition by Lewis [Lew79]. This construction was somehow forgotten in the literature and the first aperiodic deterministic tileset is usually attributed to Kari in 1992 [Kar92].

In 1989, Mozes showed a general method that can be used to translate any substitution tiling into a set of Wang tiles [Moz89], which will be of course aperiodic. There are multiple generalizations of this result (depending of the exact definition of "substitution tiling"), of which we cite only a few [GS98, FO10, IGO12]. For a specific example, Socolar build such a representation [Sen95] of the chair tiling, which in our vocabulary can be done using 64 tiles.

The story stopped until 1996 when Kari invented a new method to build aperiodic tileset and obtained an aperiodic set of 14 tiles [Kar96]. This was reduced to 13 tiles by Culik [Cul96] using the same method. There was suspicion one of the 13 tiles was unnecessary, and Kari and Culik hinted to a method to show it in a unpublished manuscript. However this is not true: the method developed in this article will show this is not the case.

In 1999, Kari and Papasoglu [KP99] presented the first 4-way deterministic aperiodic set. The construction was later adapted by Lukkarilla to provided a proof of undecidability of the 4-way domino problem [Luk09].

The construction of Robinson was later analyzed [Sal89, AD01, JM97, FGS12] and simplified. Durand, Levin and Shen presented in 2004 [DLS04] a way to simplify exposition of proofs of aperiodicity of such tilesets. Ollinger used this method in 2008 to obtain an aperiodic tileset with 104 tiles [Oll08], with striking resemblance to the original set of 104 tiles by Berger. Other simplifications of Robinson constructions were given by Levin in 2005 [Lev05] and Poupet in

2010 [Pou10] using ideas similar to Robinson.

In 2008, Durand, Romashchenko and Shen provided a new construction based on the classical fixed point construction from computability theory [DSR08, DRS12].

2 Preliminaries

2.1 Wang tiles

A *Wang tile* is a unit square with colored edges. Formally, let H, V be two finite sets (the horizontal and vertical colors, respectively). A wang tile t is an element of $H^2 \times V^2$. We write $t = (t_w, t_e, t_s, t_n)$ for a Wang tile, and use interchangeably the notations t_w (resp. t_e, t_s, t_n) or $w(t)$ (resp. $e(t), s(t), n(t)$) to indicate the color on one of the edges.

A *Wang set* is a set of Wang tiles, formally viewed as a tuple (H, V, T) , where $T \subseteq H^2 \times V^2$ is the set of *tiles*. Fig. 1 presents a well known example of a Wang set. A Wang set is said to be *empty* if $T = \emptyset$.

Let $\mathcal{T} = (H, V, T)$ be a Wang set. Let $X \subseteq \mathbb{Z}^2$. A *tiling of X by \mathcal{T}* is an assignation of tiles from \mathcal{T} to X so that contiguous edges have the same color, that is it is a function $f : X \rightarrow T$ such that $e(f(x, y)) = w(f(x + 1, y))$ and $n(f(x, y)) = s(f(x, y + 1))$ for every $(x, y) \in \mathbb{Z}^2$ when the function is defined. We are especially interested in the tilings of \mathbb{Z}^2 by a Wang set \mathcal{T} . When we say a *tiling of the plane by \mathcal{T}* , or simply a *tiling by \mathcal{T}* , we mean a tiling of \mathbb{Z}^2 by \mathcal{T} .

A tiling f is *periodic* if there is a $(u, v) \in \mathbb{Z}^2 \setminus (0, 0)$ such that $f(x, y) = f(x + u, y + v)$ for every $(x, y) \in \mathbb{Z}^2$. A tiling is *aperiodic* if it is not periodic.

A Wang set *tiles X* (resp. *tiles the plane*) if there exists a tiling of X (resp. the plane) by \mathcal{T} . A Wang set is *finite* if there is no tiling of the plane by \mathcal{T} . A Wang set is *periodic* if there is a tiling t by \mathcal{T} which is periodic. A Wang set is *aperiodic* if it tiles the plane, and every tiling by \mathcal{T} is not periodic.

We quote here a few well known folklore results:

Lemma 1. *If \mathcal{T} is periodic, then there is a tiling t by \mathcal{T} with two linearly independent translation vectors (in particular a tiling t with vertical and horizontal translation vectors).*

Lemma 2. *If for every $k \in \mathbb{N}$, there exists a tiling of $[0, \dots, k] \times [0, \dots, k]$ by \mathcal{T} , then \mathcal{T} tiles the plane.*

2.2 Transducers

One of the most trivial but crucial observation we will use in this article is that Wang sets (H, V, T) may be viewed as finite state transducers, where each transition reads and writes one letter, and without initial nor final states: H is the set of states, V is the input and output alphabet, and T is the set of transitions. Fig. 1 presents in particular the popular set of Wang tiles introduced by Culik from both point of views.

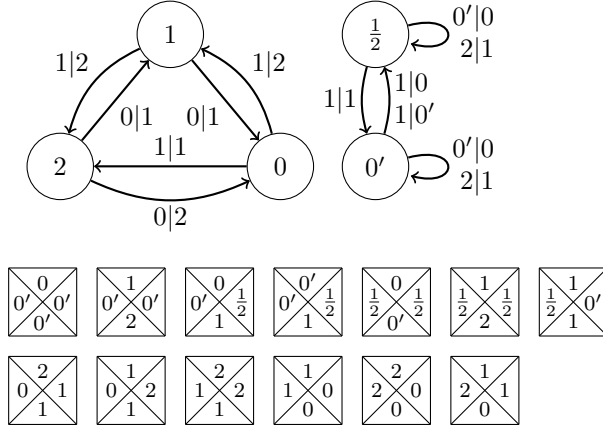

Figure 1: The aperiodic set of 13 tiles obtained by Culik from an idea of Kari: the transducer view and the tiles view.

In this formalism, tilings correspond exactly to (biinfinite) runs of the transducer. If w and w' are biinfinite words over the alphabet V , we will write $w\mathcal{T}w'$ if w' is the image of w by the transducer. The transducer is usually nondeterministic so that this is indeed a (partial) relation and not a function.

The composition of Wang sets, seen as transducers, is straightforward: Let $\mathcal{T} = (H, V, T)$ and $\mathcal{T}' = (H', V', T')$ be two Wang sets. Then $\mathcal{T} \circ \mathcal{T}'$ is the Wang set $(H \times H', V, T'')$, where

$$T'' = \{((w, w'), (e, e'), s, n') : (w, e, s, n) \in T, (w', e', s', n') \in T' \text{ and } n = s'\}.$$

Let \mathcal{T}^k , $k \in \mathbb{N}^*$ be \mathcal{T} if $k = 1$, $\mathcal{T}^{k-1} \circ \mathcal{T}$ otherwise.

A reformulation of the original question is as follows:

Lemma 3. *A Wang set \mathcal{T} is finite if there is no infinite run of the transducer \mathcal{T} : There is no biinfinite sequence $(w_k)_{k \in \mathbb{N}}$ so that $w_k \mathcal{T} w_{k+1}$ for all k .*

A Wang set \mathcal{T} is periodic iff there exists a word w and a positive integer k so that $w\mathcal{T}^k w$.

We will also use the following operations on tile sets (or transducers):

rotation Let \mathcal{T}^{tr} be (V, H, T') where $T' = \{(s, n, e, w) : (w, e, s, n) \in T\}$. This operation corresponds to a rotation of the tileset by 90 degrees.

simplification Let $s(\mathcal{T})$ be the operation that deletes from \mathcal{T} any tile that cannot be used in a tiling of a (biinfinite) line row by \mathcal{T} . This corresponds from the point of view of transducers to eliminating sources and sinks from \mathcal{T} . In particular $s(\mathcal{T})$ is empty iff there is no words w, w' s.t. $w\mathcal{T}w'$.

union $\mathcal{T} \cup \mathcal{T}'$ is the disjoint union of transducers \mathcal{T} and \mathcal{T}' : We first rename the states of both transducers so that they are all different, and then we take the union of the transitions of both transducers. Thus $w(\mathcal{T} \cup \mathcal{T}')w'$ iff $w\mathcal{T}w'$ or $w\mathcal{T}'w'$.

Equivalence of Wang sets. Once Wang sets are seen as transducers, it is easy to see that the problems under consideration do not depend actually on \mathcal{T} , but only on the relation induced by \mathcal{T} : We say that two Wang sets $\mathcal{T} = (H, V, T)$ and $\mathcal{T}' = (H', V, T')$ are *equivalent* if they are equivalent as relations, that is, for every pair of bi-infinite words (w, w') over V , $w\mathcal{T}w' \Leftrightarrow w\mathcal{T}'w'$.

In the course of the proofs and the algorithms, it will be interesting to switch between equivalent Wang sets (transducers), in particular by trying to simplify as much as possible the sets: we can for example apply the operator $s(\mathcal{T})$ to trim the colors/states (and thus the tiles/transitions) that cannot appear in a infinite row (e.g. sources/terminals of the transducer seen as a graph), or reduce the size of the transducer by coalescing “equivalent” states.

There are a few algorithms to simplify Wang sets. First, as our transducers are nothing but (nondeterministic) finite automata over the alphabet $V \times V$, it is tempting to try to *minimise* them. However state (or transition) minimisation of nondeterministic automata is PSPACE-complete ; The other strategy of building the minimal deterministic automaton is also not efficient in practice. The algorithm we used is based on the notion of *strong bisimulation equivalence* of labeled transitions systems [KS90, PT87, Val10, bie03]. It allows us to find efficiently states that are equivalent (in some sense) and thus can be collapsed together. It can be thought of as the non-deterministic equivalent of the classical minimization algorithm for deterministic automata from Hopcroft [Hop71].

3 There is no aperiodic Wang sets with 10 tiles or less

In this section, we give a brief overview of the techniques involved in the computer assisted proof that there are not aperiodic Wang set with 10 tiles or less.

The general method of the algorithm is obvious: generate all Wang sets with 10 tiles or less, and test whether there are aperiodic. There are two difficulties here: first, there are a large number of Wang sets with 10 tiles: For maximum efficiency, we have to generate as few of them as possible, that is discard as soon as possible Wang sets that are provably not aperiodic. Then we have to test the remaining sets for aperiodicity. Aperiodicity is of course an undecidable problem: our algorithm will not succeed on all Wang sets, and the remaining ones will have to be examined by hand.

3.1 Generating all Wang sets with 10 tiles or less

According to the general principle above, we actually do not have to generate all Wang sets: we can refrain from generating sets that we know are not aperiodic.

Let \mathcal{T} be a Wang set. We say that \mathcal{T} is minimally aperiodic if \mathcal{T} is aperiodic and no proper subset of \mathcal{T} is aperiodic (that is no proper subset of \mathcal{T} tiles the plane). We will introduce criteria proving that some Wang sets are not minimally aperiodic, and thus that we do not need to test them.

The key idea is to look at the graph G underlying the transducer. Note that this is actually a *multigraph*: there might be multiple edges(transitions) joining two given vertices (states), and there might also be self-loops.

This approach was also introduced in [JR12], and the following lemma is more or less implicit in this article:

Lemma 4. *Let \mathcal{T} be a Wang set, and G the corresponding graph.*

- *Suppose there exist two vertices/states/colors $u, v \in G$ so that there is an edge (hence a tile/transition) from u to v and no path from v to u . Then \mathcal{T} is not minimal aperiodic.*
- *Suppose G contains a strongly connected component which is reduced to a cycle. Then \mathcal{T} is not minimal aperiodic.*
- *If the difference between the number of edges and the number of vertices in G is less than 2, then \mathcal{T} is not minimal aperiodic.*

Proof. In terms of tiles, the first case corresponds to a tile t that can appear at most one in each row. If \mathcal{T} tiles the plane, \mathcal{T} tiles arbitrarily large regions without using the tile t . By compactness, $\mathcal{T} \setminus \{t\}$ tiles the plane.

For the second case, suppose such a component exists. This means there exist some tiles $S \subseteq \mathcal{T}$ so that every time one of the tiles in S appear, then the whole row is periodic (of period the size of the cycle). If \mathcal{T} is aperiodic, we cannot have a tiling where tiles of S appear in two different rows, as we could deduce from it a periodic tiling. As a consequence, tiles from S appear in at most one row, and using the same compactness argument as before we deduce that $\mathcal{T} \setminus S$ tiles the plane.

The proof of the third case can be found in [JR12]. □

This lemma gives a bird's eye-view of the program: For a given $n \leq 10$, generate all (multi)graphs G with n edges and at most $n - 2$ vertices satisfying the hypotheses of the lemma, then test all Wang sets for which the underlying graph in G . In terms of Wang tiles, a graph correspond to a specific assignation of colors to the east/west side: for this particular assignation, we test all possible assignations of colors to the north/south side.

The exact approach used in the software follows this principle, trying as much as possible not to generate isomorphic tilesets.

3.2 Testing Wang sets for aperiodicity

We explained in the previous section how we generated Wang sets to test. We now explain how we tested them for aperiodicity.

3.2.1 Easy cases

Recall that a Wang set is *not* aperiodic if

- Either there exists k so that $s(\mathcal{T}^k)$ is empty: there is no word w, w' so that $w\mathcal{T}^kw'$
- or there exists k so that \mathcal{T}^k is periodic: there exists a word w so that $w\mathcal{T}^kw$

The general algorithm to test for aperiodicity is therefore clear: for each k , generate \mathcal{T}^k , and test if one of the two situations happen. If it does, the set is not aperiodic. Otherwise, we go to the next k . The algorithm stops when the computer program runs out of memory. In that case, the algorithm was not able to decide if the Wang set was aperiodic (it is after all an undecidable problem), and we have to examine carefully this Wang set.

This approach works quite well in practice: when launched on a computer with a reasonable amount of memory, it eliminates a very large number of tilesets. Of course, the key idea is to simplify as much as possible \mathcal{T}^k before computing \mathcal{T}^{k+1} . Note that this should be done as fast as possible, as this will be done for *all* Wang sets. It turns out that the easy simplification that consists in deleting at each step tiles that cannot appear in a tiling of a row (i.e. vertices that are sources/terminals) is already sufficient.

It is important to note that this approach relying on transducers (test whether the Wang set tiles k consecutive rows, and if it does so periodically) turned out in practice to be much more efficient than the naive approach using tilings of squares (test whether the Wang set tiles a square of size k , and if it does so periodically).

3.2.2 Harder cases

Once this has been done, a small number of Wang sets remain (at most 200), for which the program was not able to prove that they tile the plane periodically or that they do not tile the plane.

The first step for these sets was to use the same idea as before, but with a larger memory, and additional optimizations, which involved simplifying \mathcal{T}^k as much as possible before examining it. Two additional simplifications were used: First, we may delete from \mathcal{T}^k tiles(transitions) that connect different strongly connected components: using the same argument as in Lemma 4, it is easy to see that deleting these tiles do not change the aperiodic status of \mathcal{T}^k . Second, we have applied bisimulation techniques to reduce as much as possible the size of the transducer \mathcal{T}^k . We want to stress that this technique proved to be crucial: the gain obtained by bisimulation is tremendous.

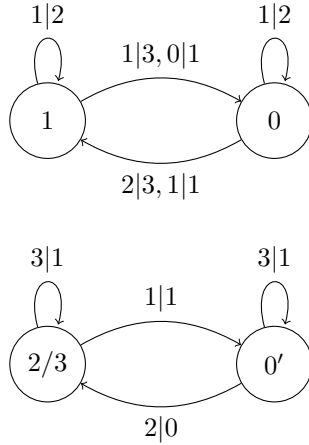

Figure 2: A set of 10 tiles that tries very hard, but fails to tile the plane. It tiles however a square of size 212×212

3.2.3 The hardest case

Using these ameliorations on the ~ 200 remaining Wang sets was successful: all of them were quickly proven to be not aperiodic. Well not entirely! One small set of indomitable tiles still held out against the program.

This particular set of tiles is presented in Fig. 2. It turned out that this particular Wang set is a special case of a general construction introduced by Kari [Kar96] of aperiodic Wang sets, except a few tiles are missing. At this point, the situation could have become desperate: It is not known if tilings obtained by the method of Kari but missing a few tiles may tile the plane. In fact, it was open whether it was possible to delete a tile from the 13 tileset from Culik [Cul96] to obtain a set that still tiles the plane¹ (and it was conjectured by both Kari and Culik that it was indeed possible).

However we were able to prove that this tileset does not in fact tile the plane. Wang sets belonging to the family identified by Kari all work in the same way: The infinite words that appear on each row can be thought of as reals, by taking the average of all numbers (between 0 and 3 in our example) that appear on the row. Then what the tileset is doing is applying a given piecewise affine map to the real number. In the case of our set of 10 tiles, the map f is as follows:

- If $1/2 \leq x \leq 3/2$, then $f(x) = 2x$
- If $3/2 \leq x \leq 3$, then $f(x) = x/3$

¹You will find many experts on tilings that recollect this story wrongly and think that the (13) Wang set by Culik is the (14) Wang set from Kari with one tile removed. It is not the case. What happened is that there is one tile from the (13) Wang set by Culik that seemed likely to be unnecessary.

As can be seen from the first transducer, there cannot be two consecutive 0 in x , this guarantees that $x \geq 1/2$ hence $x \neq 0$, and in particular that this tileset has no periodic tiling.

If we used the general method by Kari to code this particular tileset, the transducer that divides by 3 would have 8 tiles. However, our particular set of 10 tiles does so with only 4 tiles. There is a way to explain how the division by 3 works. First, let's see it like a multiplication by 3 by reversing the process. Recall that the Beatty expansion of a real x is given by $\beta_n(x) = \lceil (n+1)x \rceil - \lceil nx \rceil$. Then it can be proven:

Fact 1. *Let $0 < x \leq 1$ and define $b_n(x) = 2\beta_n(2x) - \beta_n(x)$. Then the second transducer transforms $(\beta_n)_{n \in \mathbb{N}}$ into $(b_n)_{n \in \mathbb{N}}$.*

Hence, the second transducer multiplies by 3 by doing $2 \times 2 \times x - x$ somehow. It can be seen as a composition of a transducer that transforms $(\beta_n)_{n \in \mathbb{N}}$ into $(\beta_n, b_n)_{n \in \mathbb{N}}$ (this can be done with only two states, using the method by Kari) and a transducer mapping each symbol (x, y) into $2y - x$, which can be done using only one state (this is just a relabelling).

There is indeed no reason that doing the transformation this way would work (in particular the equations given by Kari cannot be applied to this particular transducer and prove that there is indeed a tiling), and indeed it doesn't: we were able to prove that this particular Wang set does not, in fact, tile the plane.

Once this tileset was identified as belonging to the family of Kari tilesets, it is indeed easy to see that, should it tile the plane, it tiles a half plane starting from a word consisting only of 3.

We then started from a transducer \mathcal{T}' that outputs a configuration with only the symbol 3, and build recursively $t_k = \mathcal{T}'\mathcal{T}^k$. It turns out that t_{31} (once reduced) is empty, which means that we cannot tile 31 consecutive rows starting from a word consisting only of 3.

Theorem 1. *There is no aperiodic Wang set with 10 tiles or less.*

Before removing unused transitions, t_{31} contains a path of 212 symbols 3. This means in particular that there exists a tiling of a rectangle of size 212×31 where the top and the bottom side are equal, thus a tiling of a infinite vertical strip of width 212 by this tiling, and thus a tiling of a square of size 212×212 .

We want again to stress how much the simplification of the transducers by bisimulation was crucial. Our first proof that this tileset does not tile the plane did not use this and 3 months were needed to prove the result, generating sets of the order of 2^{32} (4 billion) tiles. Using bisimulation for the simplification of transducers, the result can be proven in 2 minutes, with the largest Wang set having 2^{26} (50 million) tiles.

The fact everything fall apart for $k = 31$ can be explained. If we identify $([0.5, 3]_{0.5 \sim 3}, \times)$ with the unit circle $([0, 1]_{0 \sim 1}, +)$, what f is doing is now just an addition (modulo 1) of $\frac{\log 2}{\log 2 + \log 3}$. Now $31 \frac{\log 2}{\log 2 + \log 3} = 11.992$ is near an integer, which means that \mathcal{T}^{31} is "almost" the identity map. During the 30 first steps, our map \mathcal{T} is able to deceive us and pretend it would tile the plane by using

the degrees of freedom we have in the coding of the reals. For $k = 31$, this is not possible anymore.

It turns out that the exact same method can be used for the set of 12 tiles obtained starting from the set by Culik, and removing one tile. It corresponds to the same rotation, and we observe indeed the same behaviour: starting from a configuration of all 2, it is not possible to tile 31 consecutive rows:

Theorem 2. *The set of 13 tiles by Culik is minimal aperiodic: if any tile is removed from this set, it does not tile the plane anymore.*

Note that the situation is still not well understood and we can consider ourselves lucky to obtain the result: First, we have to execute the transducers in the good direction: $\mathcal{T}'\mathcal{T}^{-31}$ is nonempty. Furthermore, the next step when \mathcal{T}^k returns near an integer is for $k = 106$, and no computer, using our technique, has enough memory to hope computing \mathcal{T}^{106} .

Conjecture 1. *Every aperiodic tiling obtained by the method of Kari is minimal aperiodic.*

4 An aperiodic Wang set of 11 tiles - Proof Sketch

Using the same method presented in the last section, we were able to enumerate and test sets of 11 tiles, and found a few potential candidates. Of these few candidates, two of them were extremely promising and we will indeed prove that they are aperiodic sets.

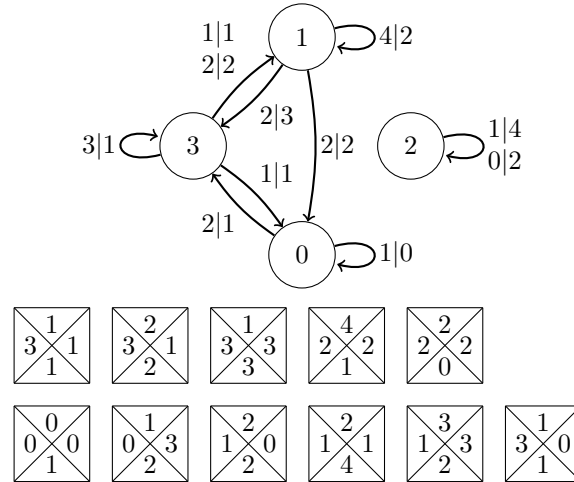

Figure 3: Wang set \mathcal{T} .

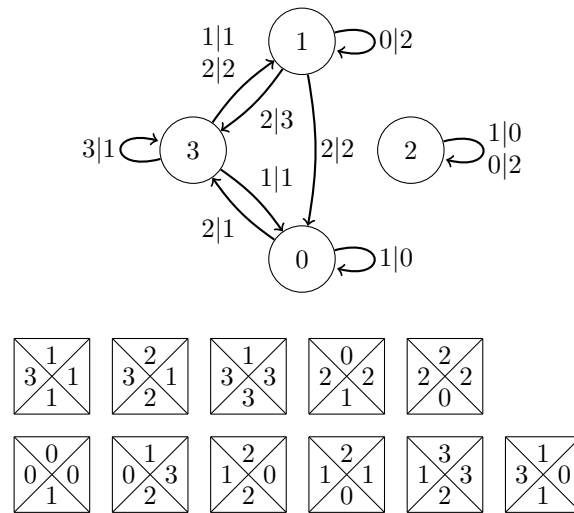

Figure 4: Wang set \mathcal{T}' .

These sets of tiles are presented in Figure 3 and 4. Both sets are very similar: the second one is obtained from the first one by collapsing the colors 4 and 0.

We focus now on the first set.

\mathcal{T} is the union of two Wang sets, \mathcal{T}_0 and \mathcal{T}_1 , of respectively 9 and 2 tiles. For $w \in \{0, 1\}^* \setminus \{\epsilon\}$, let $\mathcal{T}_w = \mathcal{T}_{w[1]} \circ \mathcal{T}_{w[2]} \circ \dots \circ \mathcal{T}_{w[|w|]}$.

It can be seen by a easy computer check that every tiling by \mathcal{T} can be decomposed into a tiling by transducers $\mathcal{T}_1\mathcal{T}_0\mathcal{T}_0\mathcal{T}_0$ and $\mathcal{T}_1\mathcal{T}_0\mathcal{T}_0$.

Simplifications of these two transducers, called \mathcal{T}_a and \mathcal{T}_b will be obtained in section 5.1 and are depicted in Fig. 5.

We then study the transducer \mathcal{T}_D formed by the two transducers \mathcal{T}_a and \mathcal{T}_b and prove that there exists a tiling by \mathcal{T}_D , and that any tiling by \mathcal{T}_D is aperiodic.

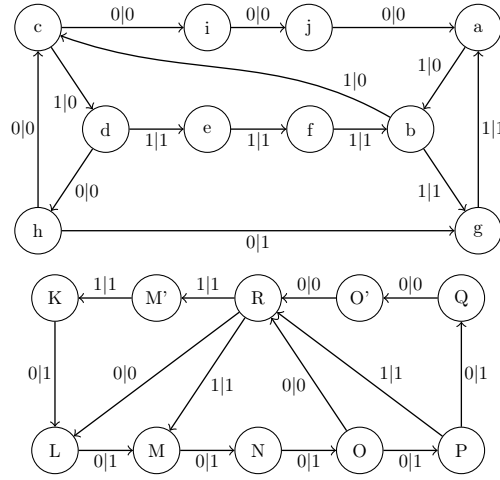

Figure 5: \mathcal{T}_D , the union of \mathcal{T}_a (top) and \mathcal{T}_b (bottom).

We will prove that the tileset is aperiodic by proving that any tiling is *substitutive*.

Let $u_{-2} = \epsilon, u_{-1} = a, u_0 = b, u_{n+2} = u_n u_{n-1} u_n$.

Let $g(n)$, $n \in \mathbb{N}$ be $(n+1)$ -th Fibonacci number, that is $g(0) = 1, g(1) = 2$ and $g(n+2) = g(n) + g(n+1)$ for every $n \in \mathbb{N}$. Remark that u_n is of size $g(n)$.

Then we will prove that, for all n , any tiling by \mathcal{T}_D is a tiling by $\mathcal{T}_{u_n}, \mathcal{T}_{u_{n+1}}, \mathcal{T}_{u_{n+2}}$. (This is obvious by definition for $n = -2, -1$). For this, we now introduce a family of transducers, presented in Fig 6, and we will prove

- We prove (section 5.2) that every tiling by $\mathcal{T}_D = \mathcal{T}_a \cup \mathcal{T}_b$ can be seen as a tiling by $\mathcal{T}_{u_0} \cup \mathcal{T}_{u_1} \cup \mathcal{T}_{u_2} = \mathcal{T}_b \cup \mathcal{T}_{aa} \cup \mathcal{T}_{bab}$.
- We prove (section 5.2) that $\mathcal{T}_{u_0}, \mathcal{T}_{u_1}$ and \mathcal{T}_{u_2} , when occurring in a tiling of the entire plane, can be simplified to obtain the three transducers $\mathcal{T}_0, \mathcal{T}_1, \mathcal{T}_2$.

T_n for n odd:

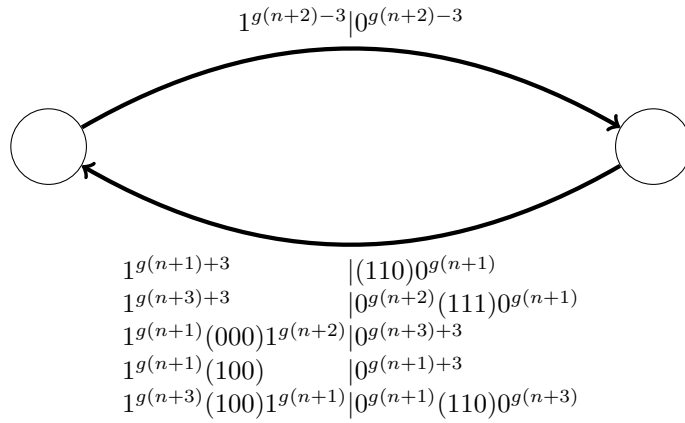

T_n for n even:

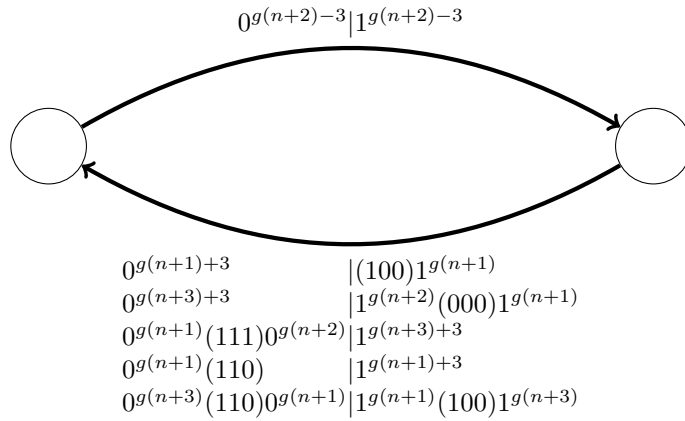

Figure 6: The family of transducers T_n

- We prove (section 6) that $T_{n+3} = T_{n+1} \circ T_n \circ T_{n+1}$ for all n , which proves that \mathcal{T}_{u_n} can be simplified to obtain T_n
- We then prove (section 7) that any tiling by $\mathcal{T}_{u_n}, \mathcal{T}_{u_{n+1}}$ and $\mathcal{T}_{u_{n+2}}$ can be rewritten as a tiling by $\mathcal{T}_{u_{n+1}}, \mathcal{T}_{u_{n+2}}, \mathcal{T}_{u_{n+3}}$, by replacing any block $\mathcal{T}_{u_{n+1}} \mathcal{T}_{u_n} \mathcal{T}_{u_{n+1}}$ by $\mathcal{T}_{u_{n+3}}$ (the difficulty is to prove that by doing this, there is no remaining occurrence of \mathcal{T}_{u_n}).
- This proves in particular that every tiling is aperiodic.
- From the description of T_n , it is clear that the transducer T_n (hence \mathcal{T}_{u_n}) is nonempty. This implies that there exists a tiling of one row by \mathcal{T}_{u_n} , hence a tiling of $g(n)$ consecutive rows by \mathcal{T}_a and \mathcal{T}_b , hence there exists a tiling of a plane.

Finally, we explain in section 7 how the same proof gives us also the aperiodicity of the set \mathcal{T}' .

5 From \mathcal{T} to \mathcal{T}_D then to T_0, T_1, T_2

5.1 From \mathcal{T} to \mathcal{T}_D

Recall that our Wang set \mathcal{T} can be seen as the union of two Wang sets, \mathcal{T}_0 and \mathcal{T}_1 , of respectively 9 and 2 tiles.

For $w \in \{0, 1\}^* \setminus \{\epsilon\}$, let $\mathcal{T}_w = \mathcal{T}_{w[1]} \circ \mathcal{T}_{w[2]} \circ \dots \circ \mathcal{T}_{w[|w|]}$. The following facts can be easily checked by computer or by hand:

Fact 2. *The transducers $s(\mathcal{T}_{11})$, $s(\mathcal{T}_{101})$, $s(\mathcal{T}_{1001})$ and $s(\mathcal{T}_{00000})$ are empty.*

Thus, if t is a tiling by \mathcal{T} , then there exists a bi-infinite binary word $w \in \{1000, 10000\}^{\mathbb{Z}}$ such that $t(x, y) \in T(\mathcal{T}_{w[y]})$ for every $x, y \in \mathbb{Z}$. Let $\mathcal{T}_A = s(\mathcal{T}_{1000} \cup \mathcal{T}_{10000})$ (see Figure 7a). There is a bijection between the tilings by \mathcal{T} and the tilings by \mathcal{T}_A , and \mathcal{T} is aperiodic if and only if \mathcal{T}_A is aperiodic.

We see that the transducer \mathcal{T}_A never reads 2, 3 nor 4. Thus the transitions that write 2, 3 or 4 are never used in a tiling by \mathcal{T} . Let \mathcal{T}_B (see Figure 7b) be the transducer \mathcal{T}_A after removing these unused transitions, and deleting states that cannot appear in a tiling of a row (i.e. sources and sinks). Then t is a tiling by \mathcal{T}_A if and only if t is a tiling by \mathcal{T}_B , and \mathcal{T}_B is aperiodic if and only if \mathcal{T}_A is.

Now we simplify a bit the transducer \mathcal{T}_B using bisimulation. The states 23300 and 23310 have the same incoming transitions, hence can be coalesced into one state. The same goes for states 21300 and 21310, and for states 2300 and 2310. Once we coalesce all those states, we obtain the Wang set \mathcal{T}_C depicted in Figure 7c.

\mathcal{T}_B and \mathcal{T}_C are equivalent. Thus \mathcal{T}_B is aperiodic if and only if \mathcal{T}_C is aperiodic.

Proposition 1. *Let $(w_i)_{i \in \mathbb{Z}}$ be a bi-infinite sequence of bi-infinite binary words such that $w_i \mathcal{T}_C w_{i+1}$ for every $i \in \mathbb{Z}$. Then for every $i \in \mathbb{Z}$, w_i is (010, 101)-free.*

Proof. We consider the tiling in the other direction, and look at the transducer $(\mathcal{T}_C^{\text{tr}})^3$. This transducer has 8 states (that corresponds respectively to 000, 001, ... 111) and a quick computer check shows that in this transducer the states 010 and 101 are respectively a source and a sink. As a consequence, these two states cannot appear in a tiling of the plane by $(\mathcal{T}_C^{\text{tr}})^3$, hence 101 and 010 cannot appear in any line of a tiling by \mathcal{T}_C . \square

In a tiling by \mathcal{T}_C , the transition from Q to O is never followed by a transition from O to P, otherwise it writes a 101. Similarly, a transition from M to K is never preceded by a transition from L to M, otherwise it reads a 010. Thus there is a bijection between tilings by \mathcal{T}_C and tilings by \mathcal{T}_D (Figure 7d).

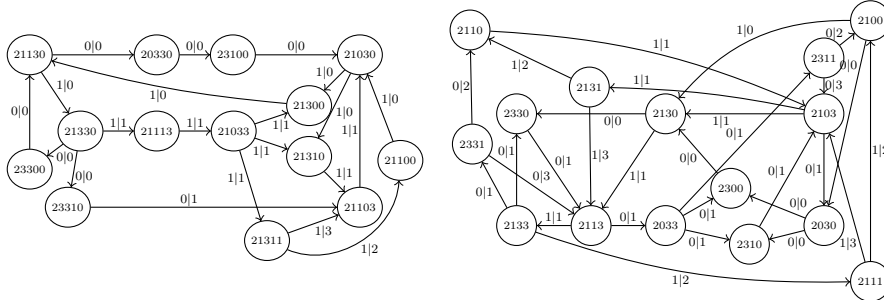

(a) \mathcal{T}_A , the union of $s(\mathcal{T}_{1000})$ (left) and $s(\mathcal{T}_{1000})$ (right).

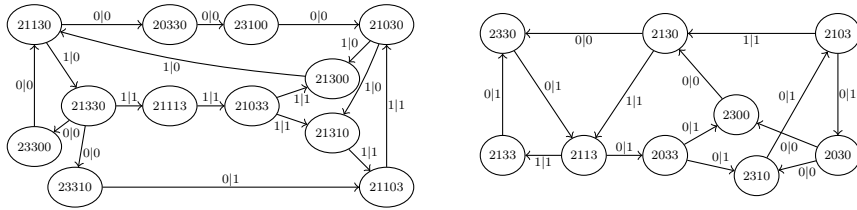

(b) \mathcal{T}_B corresponds to \mathcal{T}_A when unused transitions are deleted.

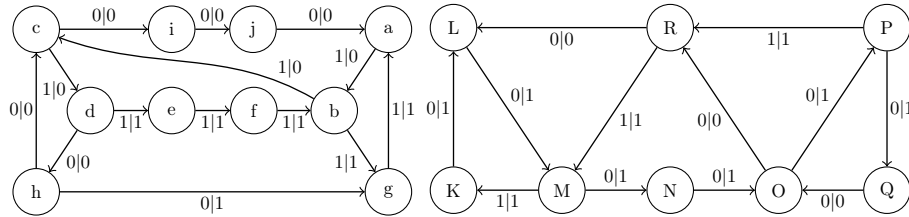

(c) \mathcal{T}_C is the simplification of \mathcal{T}_B by bisimulation.

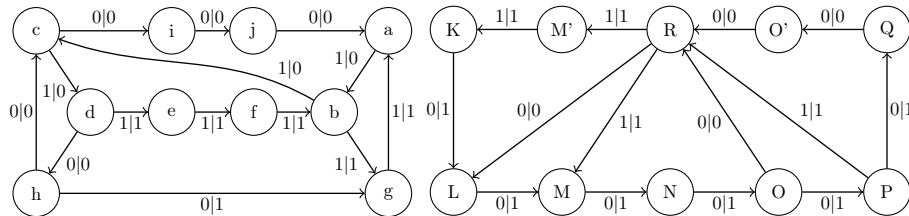

(d) \mathcal{T}_D is the simplification of \mathcal{T}_C using the fact that the successions of symbols 101 and 010 cannot appear. The transducers to the left and to the right are called respectively \mathcal{T}_a and \mathcal{T}_b .

Figure 7: The different steps of simplification of \mathcal{T}_A .

5.2 From \mathcal{T}_D to T_0, T_1, T_2

Let \mathcal{T}_a and \mathcal{T}_b be the two connected component of \mathcal{T}_D . For a word $w \in \{a, b\}^*$, let $\mathcal{T}_w = \mathcal{T}_{w[1]} \circ \mathcal{T}_{w[2]} \circ \dots \circ \mathcal{T}_{w[|w|]}$. The following fact can be easily checked by computer or by hand:

Fact 3. *The transducers $s(\mathcal{T}_{bb})$, $s(\mathcal{T}_{aaa})$ and $s(\mathcal{T}_{babab})$ are empty.*

It is a classical exercise to show that this implies that if t is a tiling by \mathcal{T}_C then there exists a bi-infinite binary word $w \in \{b, aa, bab\}^{\mathbb{Z}}$ such that $t(x, y) \in T(\mathcal{T}_{w[y]})$ for every $y \in \mathbb{Z}$. That is, t is image of a tiling by $\mathcal{T}_b \cup \mathcal{T}_{aa} \cup \mathcal{T}_{bab}$.

We will now simplify the three transducers.

Case of \mathcal{T}_b . In \mathcal{T}_b , every path eventually go to the state “N”. Thus \mathcal{T}_b is equivalent to the following transducer (written in a compact form):

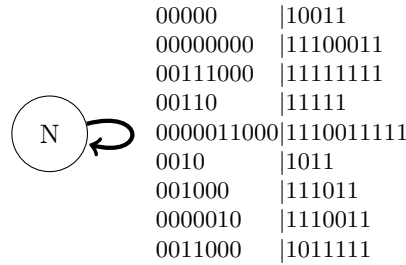

In the previous transducer, the last 4 transitions are never used in a tiling of the plane, since they read 010 or write 101. So we can simplify the transducer into:

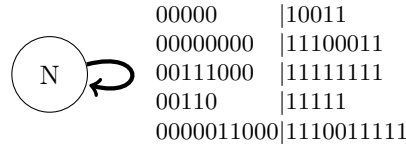

This transducer is equivalent to T_0 , that we recall here for comparison:

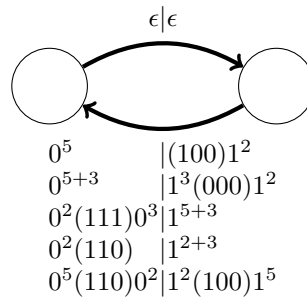

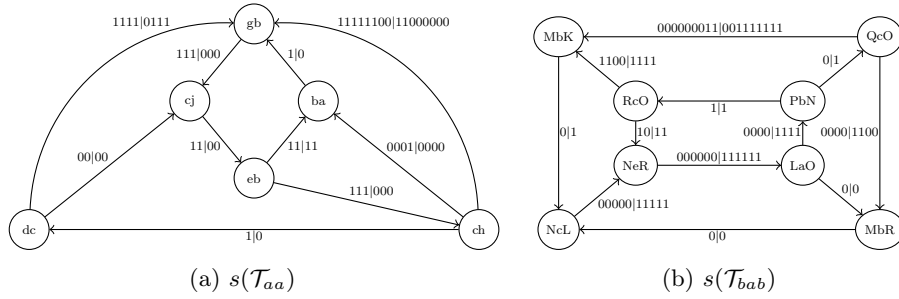
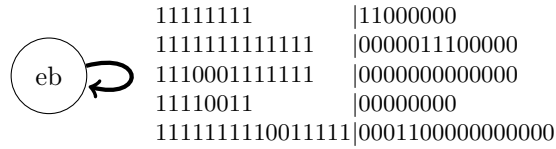
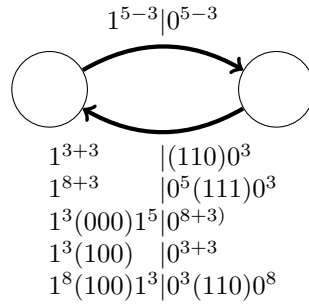

Figure 8: $s(\mathcal{T}_{aa})$ and $s(\mathcal{T}_{bab})$.

Case of \mathcal{T}_{aa} . The transducer $s(\mathcal{T}_{aa})$ is depicted in Figure 8a in a compact form. In this transducer, every path eventually go to the state “eb”. Then $s(\mathcal{T}_{aa})$ is equivalent to the following transducer (written in a compact form):



This transducer is clearly equivalent to T_1 , that we recall for convenience:



Case of \mathcal{T}_{bab} . The transducer $s(\mathcal{T}_{bab})$ is depicted in Figure 8b.

In this transducer, every path eventually go to the state “NeR”. Then $s(\mathcal{T}_{bab})$ is equivalent to the following transducer (wrote in a compact form):

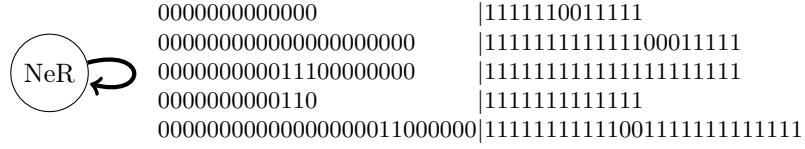

This transducer is clearly equivalent to T_2 , that we recall for the reader convenience:

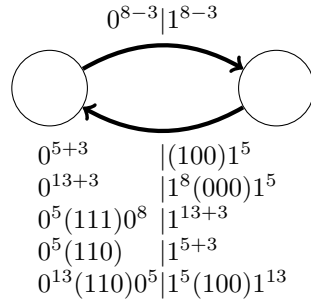

6 From T_n, T_{n+1}, T_{n+2} to $T_{n+1}, T_{n+2}, T_{n+3}$

For the reader convenience, we recall the definition of the family of transducers, and we introduce notations for the transitions T_n for n even:

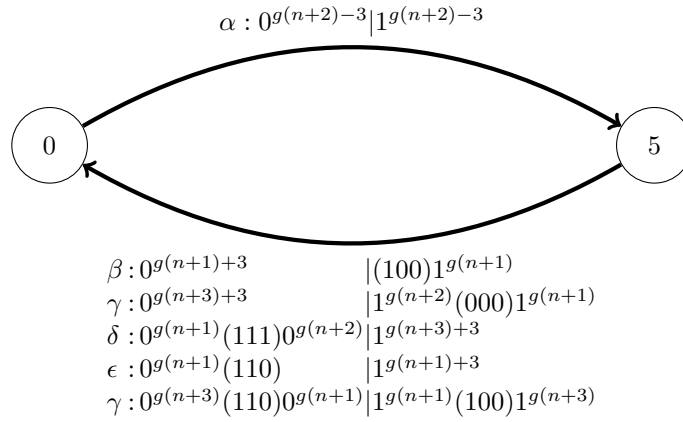

T_{n+1} for n even:

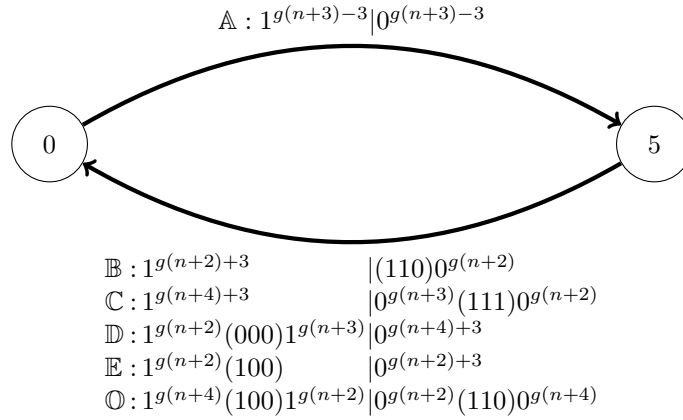

Before going into the proof, we first give some remarks.

- T_n for n even and n odd are essentially similar. This means it is sufficient to prove that $T_{n+3} = T_{n+1} \circ T_n \circ T_{n+1}$ for n even, and the result for n odd follows.
- Apply the following transformation to T_n : Change input and output, and reverse the edges: reverse the direction and mirror (reverse) the words, and exchange the symbols 0 and 1. Then we obtain T_n again (for n even, with β playing the role of ϵ , δ the role of γ , and α and ω their own role). This internal symmetry will be used a lot in the proofs.

- All transitions are symmetric and easy to understand, except the self-symmetric tiles ω and \mathbb{O} . These transitions actually cannot occur in the tiling of the plane, but a transition of shape ω or \mathbb{O} large enough can appear in a finite strip large enough. It means it is not possible to do the proof without speaking about these transitions, even if they cannot appear in a tiling of the plane.

We now proceed to prove the result. As said before, we now suppose that n is even, and we will look at the sequence of transducers $T_{n+1} \circ T_n \circ T_{n+1}$.

The following table represent the possible distance between two consecutive markers (i.e. 000 and 100) as inputs of T_{n+1} .

First Marker	Second Marker	Distance
(000) from D	(000) from D	$g(n+5)$
(000) from D	(100) from E	$g(n+5)$
(000) from D	(100) from O	$g(n+5)+g(n+3)$
(100) from E	(000) from D	$g(n+4)$
(100) from E	(100) from E	$g(n+4)$
(100) from E	(100) from O	$g(n+5)$
(100) from O	(000) from D	$g(n+4)+g(n+2)$
(100) from O	(100) from E	$g(n+4)+g(n+2)$
(100) from O	(100) from O	$2g(n+4)$

$\left. \begin{array}{l} \\ \\ \\ \\ \\ \\ \\ \\ \\ \end{array} \right\} \begin{array}{l} +ag(n+4)+bg(n+5) \\ a, b \in \mathbb{N} \end{array}$

To prove the main result, we will prove that the transitions in the transducer T_n (when surrounded by transducers T_{n+1}) must be done in a certain order.

In the following, we deliberately omit the transition α : When we say that $\gamma\beta$ cannot appear, we mean that it is impossible to see successively the transitions γ , then α , then β in a run of the transducer T_n (when surrounded by transducers T_{n+1}).

Lemma 5. *The following words cannot appear:*

- $\gamma\omega, \gamma\gamma, \gamma\beta, \beta\omega, \beta\beta, \beta\epsilon\beta, \gamma\epsilon\beta, \beta\delta\epsilon\beta, \gamma\delta\epsilon\beta$
- $\omega\delta, \delta\delta, \epsilon\delta, \omega\epsilon, \epsilon\epsilon, \epsilon\beta\epsilon, \epsilon\beta\delta, \epsilon\beta\gamma\epsilon, \epsilon\beta\gamma\delta$

Proof. All the following successions of transitions are impossible due to the input constraints on T_{n+1} :

Case	Why it is impossible
$\gamma\omega$	(000) and (100) separated by $g(n+1) + g(n+3)$
$\gamma\gamma$	(000) and (000) separated by $g(n+4)$
$\gamma\beta$	(000) and (100) separated by $g(n+3)$
$\beta\omega$	(100) and (100) separated by $g(n+1) + g(n+3)$
$\beta\beta$	(100) and (100) separated by $g(n+3)$
$\beta\epsilon\beta$	(100) and (100) separated by $2g(n+3)$
$\gamma\epsilon\beta$	(000) and (100) separated by $2g(n+3)$
$\beta\delta\epsilon\beta$	(100) and (100) separated by $2g(n+4) + g(n+1)$
$\gamma\delta\epsilon\beta$	(000) and (100) separated by $2g(n+4) + g(n+1)$

All others cases follow by symmetry. \square

Lemma 6. ω cannot appear.

Proof. Case disjunction on what appears before:

Case	Why it is impossible
$\beta\omega$	see above
$\gamma\omega$	see above
$\beta\delta\omega$	(100) and (100) separated by $g(n+4) + g(n+3) + g(n+1)$
$\gamma\delta\omega$	(000) and (100) separated by $g(n+4) + g(n+3) + g(n+1)$
$\beta\epsilon\omega$	(100) and (100) separated by $g(n+4) + 2g(n+1)$
$\gamma\epsilon\omega$	(000) and (100) separated by $g(n+4) + 2g(n+1)$
$\beta\delta\epsilon\omega$	(100), (100) separated by $g(n+5) + g(n+3) + g(n+1) = 2g(n+4) + 2g(n+1)$
$\gamma\delta\epsilon\omega$	(000), (100) separated by $g(n+5) + g(n+3) + g(n+1) = 2g(n+4) + 2g(n+1)$

\square

Lemma 7. \circledast cannot appear.

Proof. Suppose that \circledast appear in the top transducer (i.e. the transducers with input T_n). This means the (100) marker is generated, the only possibility being by β .

We prove there is no possibility to find transitions after this β .

Case	Why it is impossible starting from \circledast
$\beta\gamma$	(100) and (000) separated by $g(n+4)$
$\beta\delta\beta$	(100) and (100) separated by $g(n+4) + g(n+3)$
$\beta\delta\gamma$	(100) and (000) separated by $g(n+4) + g(n+1) + g(n+3)$
$\beta\delta\epsilon\beta$	(100) and (100) separated by $2g(n+4) + g(n+1)$
$\beta\delta\epsilon\gamma$	(100) and (000) separated by $2g(n+4) + g(n+3)$
$\beta\epsilon\gamma$	(100) and (000) separated by $g(n+5)$

By symmetry, \circledast cannot appear in the bottom transducer. \square

Now that \circledast has disappeared, the possible distances between the markers are greatly simplified

First Marker	Second Marker	Distance
(000)	(000)	$g(n+5)$
(000)	(100)	$g(n+5)$
(100)	(000)	$g(n+4)$
(100)	(100)	$g(n+4)$

$\left. \begin{array}{l} \\ \\ \\ \end{array} \right\} \begin{array}{l} +ag(n+4) + bg(n+5) \\ a, b \in \mathbb{N} \end{array}$

Lemma 8. The following words do not appear: $\beta\epsilon$, $\epsilon\beta$ $\beta\delta\beta$, $\delta\gamma\delta$, as well as $\epsilon\gamma\epsilon$ and $\gamma\delta\gamma$

Proof. $\beta\epsilon$ should be followed by γ which leads to (100) and (000) separated by $g(n+5)$.

$\epsilon\beta$ should be preceded by a δ , which cannot be preceded by anything.

Case	Why it is impossible
$\beta\delta\beta$	(100), (100) separated by $g(n+4) + g(n+3)$
$\gamma\delta\gamma$	(000), (000) separated by $g(n+5) + g(n+2)$

The last two follow by symmetry. □

Lemma 9. *Every infinite path on the transducer T_n can be written as paths on the following graph:*

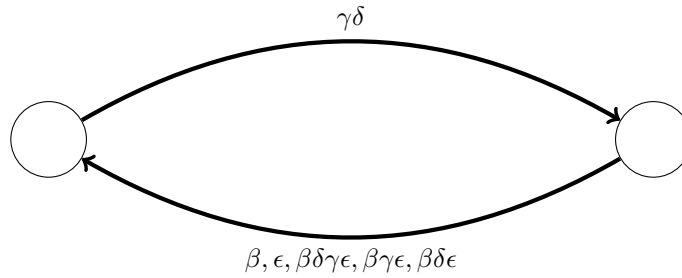

Proof. Clear: all other words are forbidden by the previous lemmas □

Recall that in this picture, words α have been forgotten. We now rewrite it adding the transitions α .

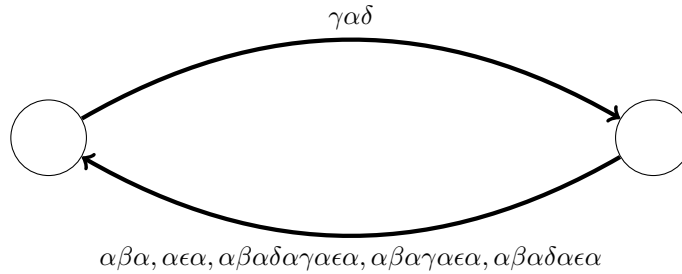

All transitions in the picture will be called *meta-transitions*.

We now have a more accurate description of the behaviour of the transducer T_n when surrounded by transducers T_{n+1} . This will be sufficient to prove the results. We will see indeed that each of the six meta-transitions depicted can be completed in only one way by transitions of T_{n+1} . This will give us six tiles, which (almost) correspond to the transitions of T_{n+3} .

We will use drawings to prove the result. Let first draw all tiles: The pictures will be self-explanatory.

First, the transitions of T_n , seen as tiles:

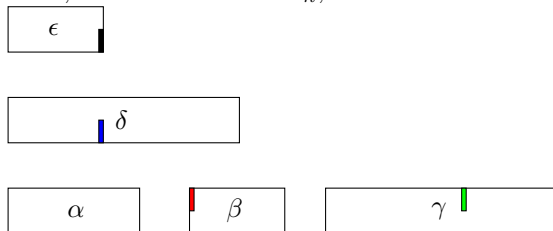

Then the transitions of T_{n+1} :

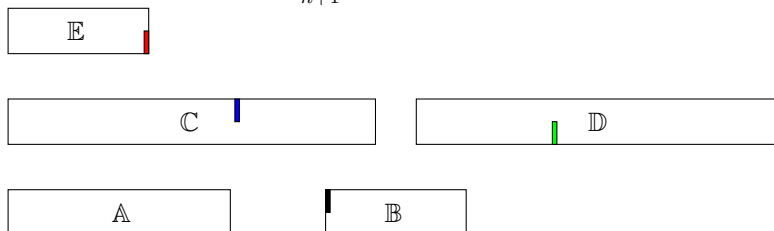

We now first look at $\gamma\delta$. By necessity, the following transitions of T_{n+1} should surround it:

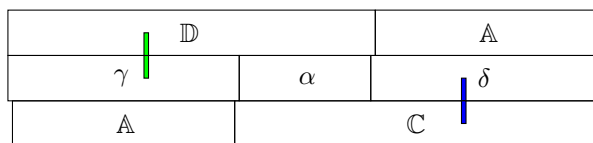

Note that the three transducers are aligned (up to a shift of ± 3) when $\gamma\alpha\delta$ is present. As all other meta-transitions are enclosed by the meta-transition $\gamma\alpha\delta$, This means that in an execution of $T_{n+1} \circ T_n \circ T_{n+1}$, every other meta-transition should be surrounded above and below by transitions of T_{n+1} that almost align with it. Moreover the transitions of T_{n+1} below should begin by \mathbb{A} and the transitions of T_{n+1} above should end with \mathbb{A} . It turns out that there is only one way to do this for any of the meta-transitions.

This gives for ϵ and β :

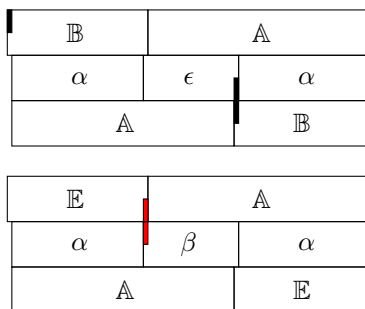

This gives for $\beta\gamma\epsilon$ and $\beta\delta\epsilon$:

E	A	C	A
α	β	δ	α
A	C	A	B

E	A	D	A
α	β	γ	α
A	D	A	B

And the piece de resistance $\beta\delta\gamma\epsilon$:

E	A	B	A	D	A
α	β	δ	α	γ	α
A	C	A	E	A	B

We now look at the transducer T' we obtain with the preceding six pieces. Remark that $T' = T_n \circ T_{n+1} \circ T_n \circ \sigma^3$ where σ is the shift:

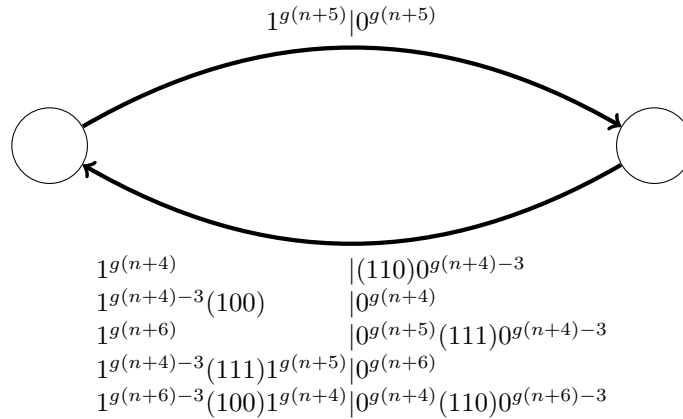

It is easy to see that T' is exactly T_{n+3} up to a shift of 3.

Theorem 3. $T_{n+3} = T_n \circ T_{n+1} \circ T_n$.

7 End of the proof

7.1 Aperiodicity of \mathcal{T}

Theorem 4. *Every infinite composition of the transducers T_n, T_{n+1}, T_{n+2} can be rewritten as a composition of transducers $T_{n+1}, T_{n+2}, T_{n+3}$ by replacing every block $T_{n+1} \circ T_n \circ T_{n+1}$ by T_{n+3} . In particular, every tiling by T_0, T_1 and T_2 is aperiodic.*

Proof. It is easy to see, given the inputs of T_n, T_{n+1} and T_{n+2} , that every T_n should be bordered by the transducers T_{n+1} .

It therefore remains to show that $T_{n+1} \circ T_n \circ T_{n+1} \circ T_n \circ T_{n+1}$ cannot appear.

By the previous section, T_n , when bordered by T_{n+1} on both sides, can be rewritten as concatenations of blocks of the following five types: $\beta\gamma\delta$, $\epsilon\gamma\delta$, $\beta\delta\gamma\epsilon\gamma\delta$, $\beta\gamma\epsilon\gamma\delta$ and $\beta\delta\epsilon\gamma\delta$.

However, as $T_{n+1} \circ T_n \circ T_{n+1} \circ T_n \circ T_{n+1} = T_{n+3} \circ T_n \circ T_{n+1}$, the block $\epsilon\gamma\delta$ (and any block containing it) cannot appear in the execution of the transducer T_n is impossible, as T_{n+3} does not produce any input that where 100 and 000 are that close. So the only block that remain possibly is $\beta\gamma\delta$. But T_{n+3} does not produce any input where 000 and 000 are at distance $g(n+6)$. \square

Corollary 1. *The Wang set corresponding to the transducer $T_0 \cup T_1 \cup T_2$ is aperiodic*

Corollary 2. *The Wang set $\mathcal{T}_D = \mathcal{T}_a \cup \mathcal{T}_b$ is aperiodic. Furthermore, the set of words $u \in \{a, b\}^*$ s.t. the sequence of transducers \mathcal{T}_u appear in a tiling of the plane is exactly the set of factors of the Fibonacci word (i.e. the fixed point of the morphism $a \rightarrow ab, b \rightarrow a$), i.e. the set of factors of sturmian words of slope $1/\phi$, for ϕ the golden mean.*

The set of biinfinite words $u \in \{a, b\}^{\mathbb{Z}}$ s.t \mathcal{T}_u represents a valid tiling of the plane are exactly the sturmian words of slope $1/\phi$.

See [BS02] for some references on sturmian words.

Proof. The sequence of words u_n we defined is the sequence of singular factors of the Fibonacci word (see for example [WW94]). Thus, on tilings by $\mathcal{T}_a \cup \mathcal{T}_b$, the vertical sequence on $\{a, b\}$ have the same set of factors that the Fibonacci word. \square

Corollary 3. *The Wang set \mathcal{T} is aperiodic. Furthermore, the set of words $u \in \{0, 1\}^*$ s.t. the sequence of transducers \mathcal{T}_u appear in a tiling of the plane is exactly the set of factors of sturmian words of slope $\phi/(5\phi-1)$, for ϕ the golden mean.*

The set of biinfinite words $u \in \{0, 1\}^{\mathbb{Z}}$ s.t \mathcal{T}_u represents a valid tiling of the plane are exactly the sturmian words of slope $\phi/(5\phi-1)$.

Proof. Let ψ be the morphism $a \mapsto 10000, b \mapsto 1000$. The set of all words $u \in \{0, 1\}^{\mathbb{Z}}$ that can appear in a tiling of the whole plane are exactly the image by ψ of the sturmian words over the alphabet $\{a, b\}$ of slope $1/\phi$.

It is well known that the image of a sturmian word by ψ is again a sturmian word, see [BS02, Corollary 2.2.19], where $\psi = \tilde{G}^3 D$ (with $\{a, b\}$ instead of $\{0, 1\}$ as input alphabet). The derivation of the slope is routine. \square

7.2 Aperiodicity of \mathcal{T}'

Recall that \mathcal{T}' is the Wang set from Figure 4. This Wang set is obtained from \mathcal{T} , by merging two vertical colors: 0 and 4 in \mathcal{T} become 0 in \mathcal{T}' . Thus every tiling of \mathcal{T} can be turned into a tiling of \mathcal{T}' , and \mathcal{T}' tiles the plane. We will show in the sequel that every tiling of \mathcal{T}' can be turned into a tiling of \mathcal{T} , and thus every tiling of \mathcal{T}' is aperiodic.

\mathcal{T}' is the union of two Wang sets \mathcal{T}'_0 and \mathcal{T}'_1 of respectively 9 and 2 tiles. The following facts can be easily checked by computer. For $w \in \{0, 1\}^* \setminus \{\epsilon\}$, let $\mathcal{T}'_w = \mathcal{T}'_{w[1]} \circ \mathcal{T}'_{w[2]} \circ \dots \circ \mathcal{T}'_{w[|w|]}$.

Fact 4. *The transducers $s(\mathcal{T}'_{111})$, $s(\mathcal{T}'_{101})$, $s(\mathcal{T}'_{1001})$, $s(\mathcal{T}'_{1000001})$, $s(\mathcal{T}'_{10000001})$, $s(\mathcal{T}'_{100000000})$, $s(\mathcal{T}'_{000011})$, $s(\mathcal{T}'_{110000})$ and $s(\mathcal{T}'_{1100011})$ are empty.*

Thus, if t is a tiling by \mathcal{T}' then there exists a bi-infinite binary word $w \in \{1000, 10000, 100011000, 100000000\}^{\mathbb{Z}}$ such that $t(x, y) \in T(\mathcal{T}'_{w[y]})$ for every $x, y \in \mathbb{Z}$.

Let $\mathcal{T}'_A = s(\mathcal{T}'_{1000} \cup \mathcal{T}'_{10000} \cup \mathcal{T}'_{100000000} \cup \mathcal{T}'_{100011000})$. As before, \mathcal{T}'_A has unused transitions (those which writes 2 or 3). Once deleted, with states that cannot appear in a tiling of a row, we obtain \mathcal{T}'_B . \mathcal{T}'_B has 4 connected components: two were already present in \mathcal{T} : \mathcal{T}'_a and \mathcal{T}'_b , the third one \mathcal{T}'_c is a subset of $\mathcal{T}'_{100000000}$, and the last one \mathcal{T}'_d is a subset of $\mathcal{T}'_{100011000}$.

Proposition 2. *\mathcal{T}'_{11} is isomorphic to a subset of \mathcal{T}'_{01} , and \mathcal{T}'_{100000} is isomorphic to a subset of \mathcal{T}'_{100001} .*

Proof. \mathcal{T}'_{11} is the transducer with one state, which reads 1 and writes 2. \mathcal{T}'_{01} has also a loop that reads 1 and writes 2: the transition $(02, 02, 1, 2)$. \mathcal{T}'_{100000} and \mathcal{T}'_{100001} are depicted in Figure 9 (in a compact form). \mathcal{T}'_{100000} is isomorphic to the subset of \mathcal{T}'_{100001} drawn in bold. \square

Corollary 4. *\mathcal{T}'_c and \mathcal{T}'_d are both isomorphic to a subset of $\mathcal{T}'_a \circ \mathcal{T}'_b$.*

A tiling of \mathcal{T}'_B can thus be turned into a tiling of \mathcal{T}'_B , by substituting every tile from \mathcal{T}'_c (resp. \mathcal{T}'_d) by two tiles, one from \mathcal{T}'_a and one from \mathcal{T}'_b .

Theorem 5. *The Wang set \mathcal{T}' is aperiodic.*

Proof. The Wang set \mathcal{T}' is aperiodic if and only if \mathcal{T}'_B is aperiodic. Suppose that \mathcal{T}'_B is not aperiodic. We know that \mathcal{T}' , and thus \mathcal{T}'_B tile the plane. Take a periodic tiling by \mathcal{T}'_B . This tiling can be turned into a tiling of \mathcal{T}'_B by the Corollary 4. Thus \mathcal{T}'_B has a periodic tiling, contradiction. \square

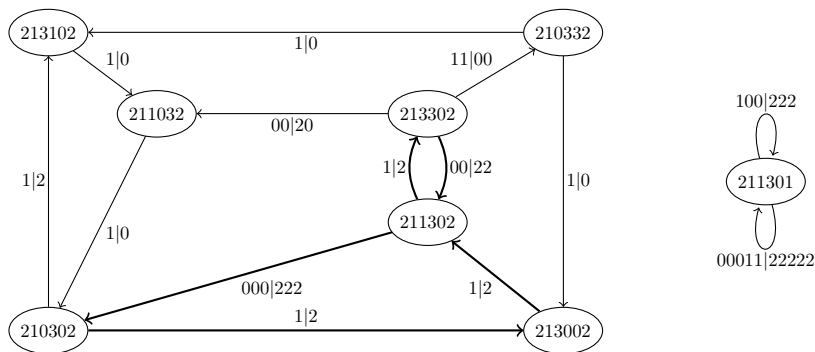

Figure 9: \mathcal{T}'_{100001} (left) and \mathcal{T}'_{100000} (right).

7.3 Concluding remarks

- The reader may regret that our substitutive system starts from $\mathcal{T}_b \cup \mathcal{T}_{aa} \cup \mathcal{T}_{bab}$ and not from $\mathcal{T}_a \cup \mathcal{T}_b \cup \mathcal{T}_{aa}$, or even from $\mathcal{T}_a \cup \mathcal{T}_b$. We do not know if this is possible. Our definition of T_n certainly does not work for $n = -1$, and the natural generalization of it is not equivalent to \mathcal{T}_a . This is somewhat obvious, as T_n (for $n \geq 0$) cannot be composed with itself, whereas \mathcal{T}_a should be composed with itself to obtain \mathcal{T}_{aa} .
- \mathcal{T}_a and \mathcal{T}_b both have the properties that they are time symmetric: If we reverse the directions of all edges, exchange inputs and outputs, and exchange 0 and 1, we obtain an equivalent transducer (it is obvious for \mathcal{T}_b and become obvious for \mathcal{T}_a if we write it in a compact form without the states h and g). This property was used to simplify the proof that the sequence (T_n) is a recursive sequence, but we do not know whether it can be used to simplify the whole proof.
- While we gave a sequence of transducers T_n , it is of course possible to give another sequence of transducers, say U_n , which are equivalent to T_n , and thus with the same properties. Our sequence T_n has nice properties, in particular the symmetry explained above and its short number of transitions, but has the drawback that the substitution once seen geometrically has small bumps due to the fact that the tiles are aligned only up to ± 3 . It is possible to find a sequence U_n for which this does not appear, by splitting some transitions of T_n into transitions of size $g(k)$ and transitions of size exactly 3. However this makes the proof that the sequence is recursive harder. We think our sequence T_n reaches a nice compromise.
- We do now know if it is possible to obtain the result directly on the original tiling set \mathcal{T} rather than \mathcal{T}_D . A difficulty is that \mathcal{T} is not purely substitutive (due for example to the fact that no Sturmian word of slope $\phi/(5\phi - 1)$ is purely morphic): What we could obtain at best is that tilings by \mathcal{T} are

images by some map ϕ of some substitutive tilings (which is more or less what we obtain in our proof).

- We have now obtained a large number of Wang sets with 11 tiles which are candidates for aperiodicity. The reader might ask why we choose to investigate this particular one. The reason is that, for this particular tileset \mathcal{T} , it is very easy for a computer to produce the transducer for \mathcal{T}^k even for large values of k ($k = 1000$). For comparison, for almost all other tilesets, we were not able to reach even $k = 30$. This suggested this tileset had some particular structure. We will not give here a full bestiary of all our candidates, but we will say that a large number of them are tileset corresponding to the method of Kari, with one tile or more omitted. With the method we described previously we were able to prove that some of them do not tile the plane, but the method did not work on all of them. We have found for now only three tilesets which were likely to be substitutive or nearly substitutive, of which two are presented in this article.
- Experimental results tend to support the following conjecture

Conjecture 2. *Let $f(n)$ be the smallest k s.t. every Wang set of size n that does not tile the plane does not tile a square of size k . Let $g(n)$ be the smallest k s.t. every Wang set of size n that tiles the plane periodically does so with a period $p \leq k$.*

Then $g(n) \leq f(n)$ for all n .

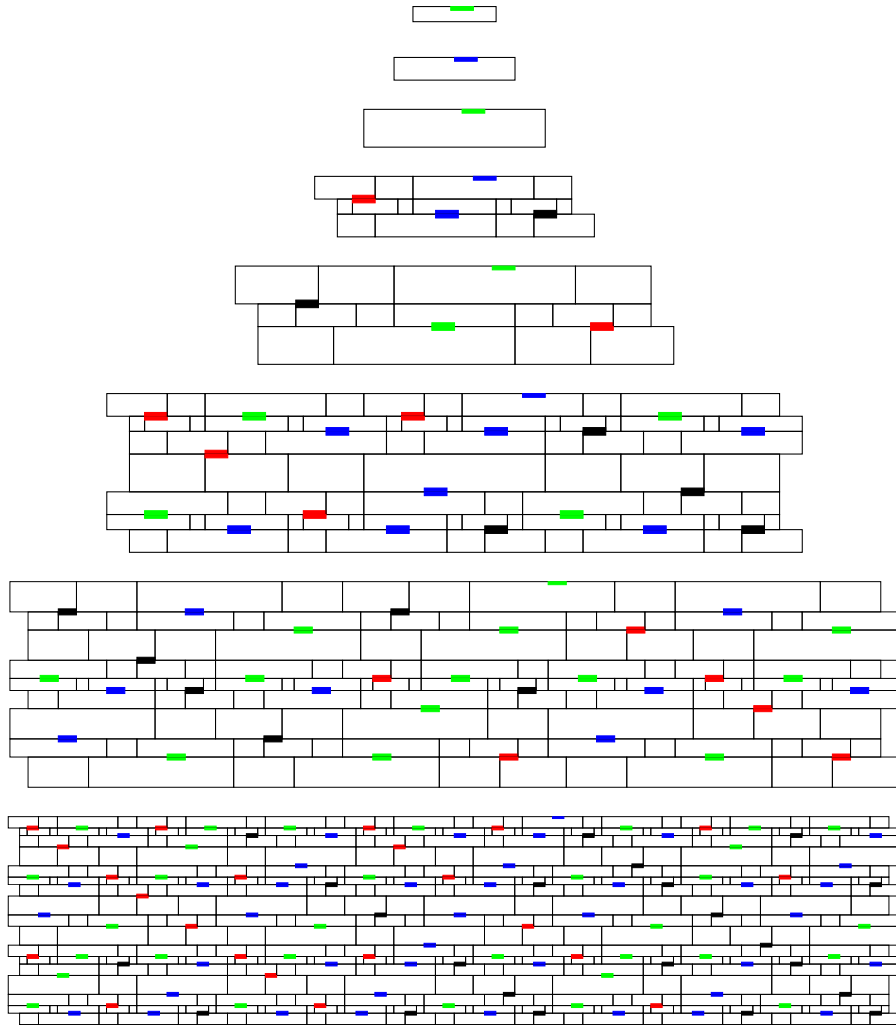

Figure 10: Representation of the meta-tile γ (resp. C if n is odd) of T_n as tiles of $T_0 \uplus T_1 \uplus T_2$ for $n = 0, 1, 2, 3, 4, 5, 6, 7$.

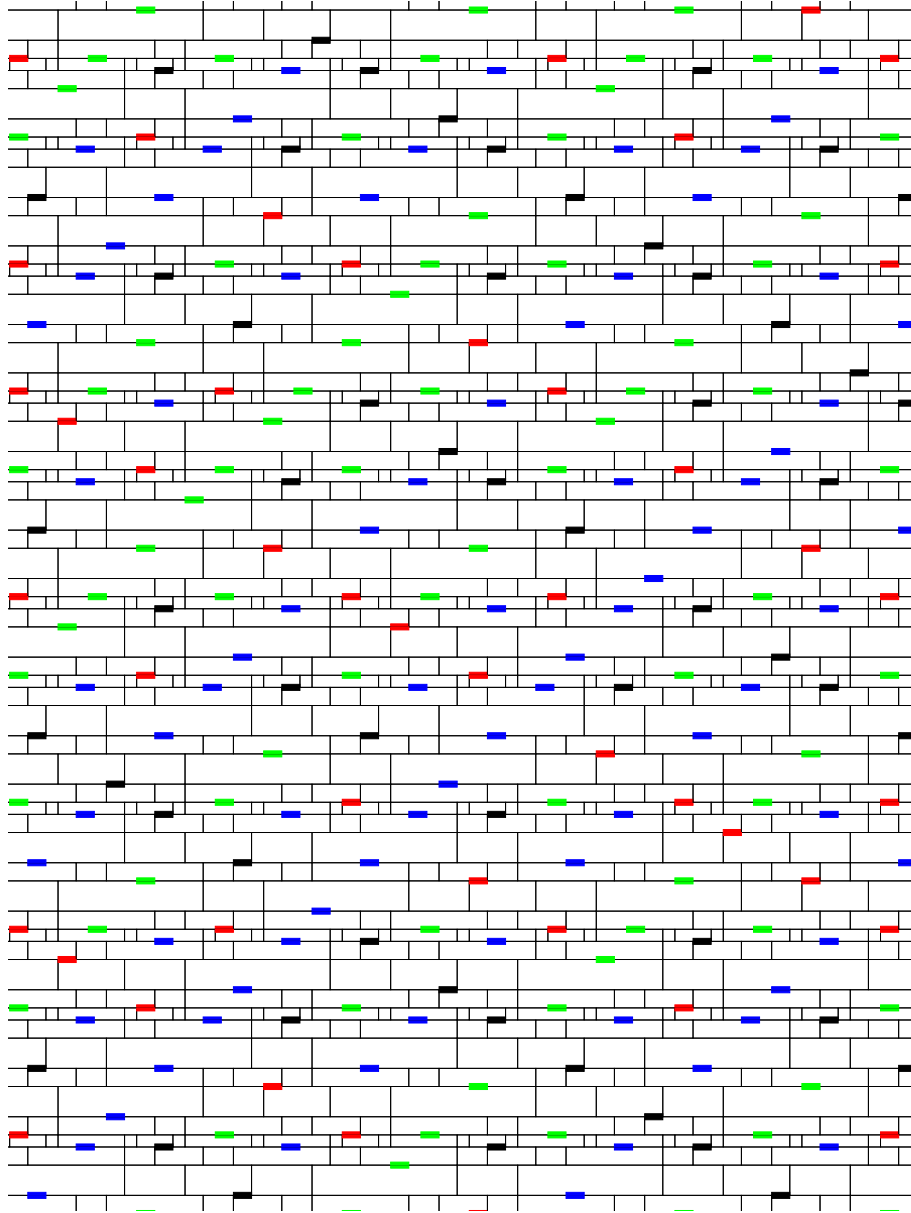

Figure 11: A fragment of a tiling by the transducers T_0, T_1, T_2 .

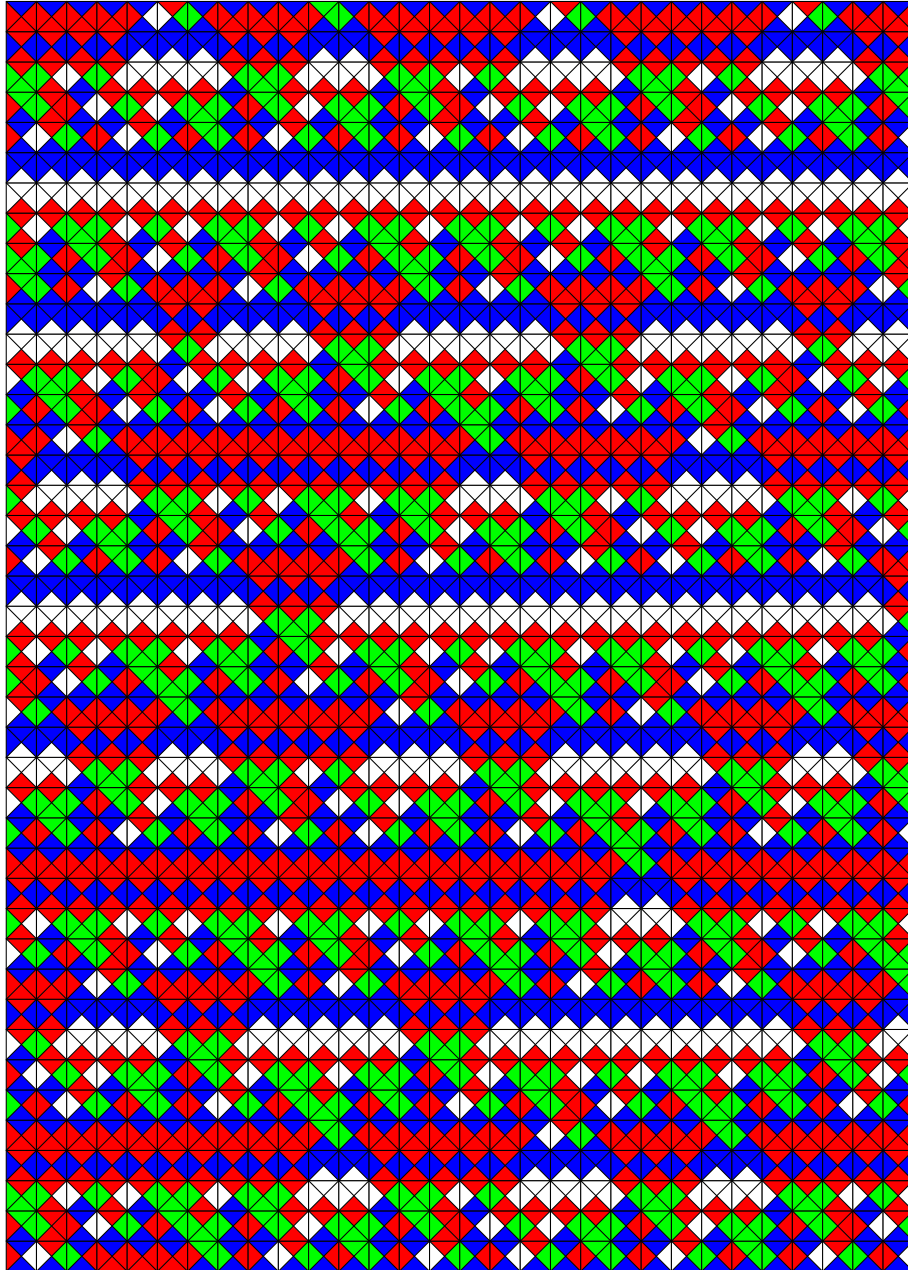

Figure 12: A fragment of a tiling by \mathcal{T}' , with $(0,1,2,3)=(\text{white},\text{red},\text{blue},\text{green})$.

References

- [AD01] Cyril Allauzen and Bruno Durand. Tiling Problems. In *The Classical Decision Problem*, Perspectives in Mathematical Logic, chapter A, pages 407–420. Springer, 2001.
- [AL74] Stål Olav Aanderaa and Harry R. Lewis. Linear Sampling and the $\forall\exists\forall$ Case of the Decision Problem. *Journal of Symbolic Logic*, 39(3):519–548, September 1974. See also [Lew79].
- [Ber64] Robert Berger. *The Undecidability of the Domino Problem*. PhD thesis, Harvard University, 1964.
- [Ber66] Robert Berger. *The Undecidability of the Domino Problem*. Number 66 in Memoirs of the American Mathematical Society. The American Mathematical Society, 1966.
- [bie03] Reducing NFAs by invariant equivalences. Lucian Ilie and Sheng Yu. *Theoretical Computer Science*, 306:373–390, 2003.
- [BS02] Jean Berstel and Patrice Séébold. Sturmian Words. In *Algebraic Combinatorics on Words*, chapter 2, pages 40–97. Cambridge University Press, 2002.
- [CHLL14] Hung-Hsun Chen, Wen-Guei Hu, De-Jan Lai, and Song-Sun Lin. Nonemptiness problems of Wang tiles with three colors. *Theoretical Computer Science*, 547:34–45, August 2014.
- [Cul96] Karel Culik II. An aperiodic set of 13 Wang tiles. *Discrete Mathematics*, 160:245–251, 1996.
- [DLS04] Bruno Durand, Leonid A. Levin, and Alexander Shen. Local rules and global order, or aperiodic tilings. *Mathematical Intelligencer*, 27(1):64–68, 2004.
- [DRS12] Bruno Durand, Andrei Romashchenko, and Alexander Shen. Fixed-point tile sets and their applications. *Journal of Computer and System Sciences*, 78(3):731–764, May 2012.
- [DSR08] Bruno Durand, Alexander Shen, and Andrei Romashchenko. Fixed Point and Aperiodic Tilings. Technical Report TR08-030, ECCC, 2008.
- [FGS12] Antoine Julien Franz Gähler and Jean Savinien. Combinatorics and Topology of the Robinson tiling. *Comptes Rendus de l’Académie des Sciences de Paris, Série I - Mathématiques*, pages 627–631, 2012.
- [FO10] Thomas Fernique and Nicolas Ollinger. Combinatorial Substitutions and Sofic Tilings . In *Journées Automates Cellulaires (JAC)*, TUCS, pages 100–110, 2010.

- [GS87] Branko Grunbaum and G.C. Shephard. *Tilings and Patterns*. W.H. Freeman, 1987.
- [GS98] Chaim Goodman-Strauss. Matching Rules and Substitution Tilings. *Annals of Mathematics*, 147(1):181–223, 1998.
- [Her70] Hans Hermes. Entscheidungsproblem und Dominospiele. In *Selecta Mathematica II*. Springer, 1970.
- [Her71] Hans Hermes. A simplified proof for the unsolvability of the decision problem in the case $\wedge \vee \wedge$. In *Logic Colloquium 1969*, volume 61 of *Studies in Logic and the Foundations of Mathematics*, pages 307–310, 1971.
- [Hop71] John E. Hopcroft. An $n \log n$ algorithm for minimizing states in a finite automaton. Technical Report STAN-CS-71-190, Stanford university, computer science department, January 1971.
- [JM97] Aimee Johnson and Kathleen Madden. Putting the Pieces Together: Understanding Robinson’s Nonperiodic Tilings. *The College Mathematics Journal*, 28(3):172–181, May 1997.
- [JR12] Emmanuel Jeandel and Nicolas Rolin. Fixed parameter undecidability for wang tilesets. In *Symposium on Cellular Automata (JAC)*, pages 69–85, 2012.
- [Kar92] Jarkko Kari. The Nilpotency Problem of One-Dimensional Cellular Automata. *SIAM Journal on Computing*, 21(3):571–586, 1992.
- [Kar96] Jarkko Kari. A small aperiodic set of Wang tiles. *Discrete Mathematics*, 160:259–264, 1996.
- [KMW62] A.S. Kahr, Edward F. Moore, and Hao Wang. Entscheidungsproblem reduced to the $\forall \exists \forall$ case. *Proceedings of the National Academy of Sciences of the United States of America*, 48(3):365–377, March 1962.
- [Knu68] Donald E. Knuth. *Fundamental Algorithms*, volume 1 of *The Art of Computer Programming*, section 2.3.4.3 The infinity lemma, pages 382–385. Addison-Wesley, first edition, 1968.
- [KP99] Jarkko Kari and P. Papasoglu. Deterministic Aperiodic Tile Sets. *Geometric And Functional Analysis*, 9:353–369, 1999.
- [KS90] Paris C. Kanellakis and Scott A. Smolka. CCS Expressions, Finite State Processes and Three Problems of Equivalence. *Information and Computation*, 86:43–68, 1990.
- [Lev05] Leonid A. Levin. Aperiodic Tilings: Breaking Translational Symmetry. *The Computer Journal*, 48(6):642–645, 2005.

- [Lew79] Harry R. Lewis. *Unsolvable Classes of Quantificational Formulas*. Addison-Wesley, 1979.
- [lGO12] Bastien le Gloannec and Nicolas Ollinger. Substitutions and Strongly Deterministic Tilesets. In *Computability in Europe (CiE)*, number 7318 in Lecture Notes in Computer Science, pages 462–471. Springer, 2012.
- [Luk09] Ville Lukkarila. The 4-way deterministic tiling problem is undecidable. *Theoretical Computer Science*, 410:1516–1533, 2009.
- [Moz89] Shahar Mozes. Tilings, substitutions systems and dynamical systems generated by them. *J. d'Analyse Math.*, 53:139–186, 1989.
- [Oll08] Nicolas Ollinger. Two-by-Two Substitution Systems and the Undecidability of the Domino Problem. In *CiE 2008*, number 5028 in Lecture Notes in Computer Science, pages 476–485, 2008.
- [Poi80] Bruno Poizat. Une théorie finiment axiomatisable et superstable. *Groupe d'études de théories stables*, 3:1–9, 1980.
- [Pou10] Victor Poupet. Yet Another Aperiodic Tile Set . In *Journées Automates Cellulaires (JAC)*, TUCS, pages 191–202, 2010.
- [PT87] Robert Paige and Robert E. Tarjan. Three Partition Refinement Algorithms. *SIAM Journal on Computing*, 16(6):973–989, December 1987.
- [Rob71] Raphael M. Robinson. Undecidability and Nonperiodicity for Tilings of the Plane. *Inventiones Mathematicae*, 12(3):177–209, 1971.
- [Sal89] Olivier Salon. Quelles tuiles! (Pavages aperiodiques du plan et automates bidimensionnels). *Journal de Théorie des Nombres de Bordeaux*, 1(1):1–26, 1989.
- [Sen95] Marjorie Senechal. *Quasicrystals and geometry*. Cambridge University Press, 1995.
- [Val10] Antti Valmari. Simple Bisimilarity Minimization in $O(m \log n)$ Time. *Fundamenta Informaticae*, 105:319–339, 2010.
- [Wan61] Hao Wang. Proving theorems by Pattern Recognition II. *Bell Systems technical journal*, 40:1–41, 1961.
- [Wan75] Hao Wang. Notes on a class of tiling problems. *Fundamenta Mathematicae*, 82:295–305, 1975.
- [WW94] Zhi-Xiong Wen and Zhi-Ying Wen. Some Properties of the Singular Words of the Fibonacci Word. *European Journal of Combinatorics*, 15(6):587–598, November 1994.