



**HAL**  
open science

## Realistic Simulation of Electric Potential Distributions of Different Stimulation Modes in an Implanted Cochlea

Kai Dang, Clair Vandersteen, Nicolas Guevara, Maureen Clerc, Dan Gnansia

### ► To cite this version:

Kai Dang, Clair Vandersteen, Nicolas Guevara, Maureen Clerc, Dan Gnansia. Realistic Simulation of Electric Potential Distributions of Different Stimulation Modes in an Implanted Cochlea. Association of Research in Otolaryngology 38th MidWinter Meeting, Feb 2015, Baltimore, United States. hal-01128098

HAL Id: hal-01128098

<https://inria.hal.science/hal-01128098>

Submitted on 9 Mar 2015

**HAL** is a multi-disciplinary open access archive for the deposit and dissemination of scientific research documents, whether they are published or not. The documents may come from teaching and research institutions in France or abroad, or from public or private research centers.

L'archive ouverte pluridisciplinaire **HAL**, est destinée au dépôt et à la diffusion de documents scientifiques de niveau recherche, publiés ou non, émanant des établissements d'enseignement et de recherche français ou étrangers, des laboratoires publics ou privés.



Distributed under a Creative Commons Attribution - NonCommercial 4.0 International License

## Introduction

Simulation of the intracochlear potentials is an important approach to study the activation of auditory nerve fibers under electrical stimulations. However, it is still unclear to which extent the simulation results are affected by precision in reproducing the exact cochlear geometry.

In this study, we address to this question by comparing the actual electric potential measured from implanted human specimen with the simulation outputs from two different parametric 3D cochlear models. One of the model is created from the default values[1] while the other is adapted to the micro-CT scan data of the implanted cochlea.

The sequence of tasks is shown in the figure below:

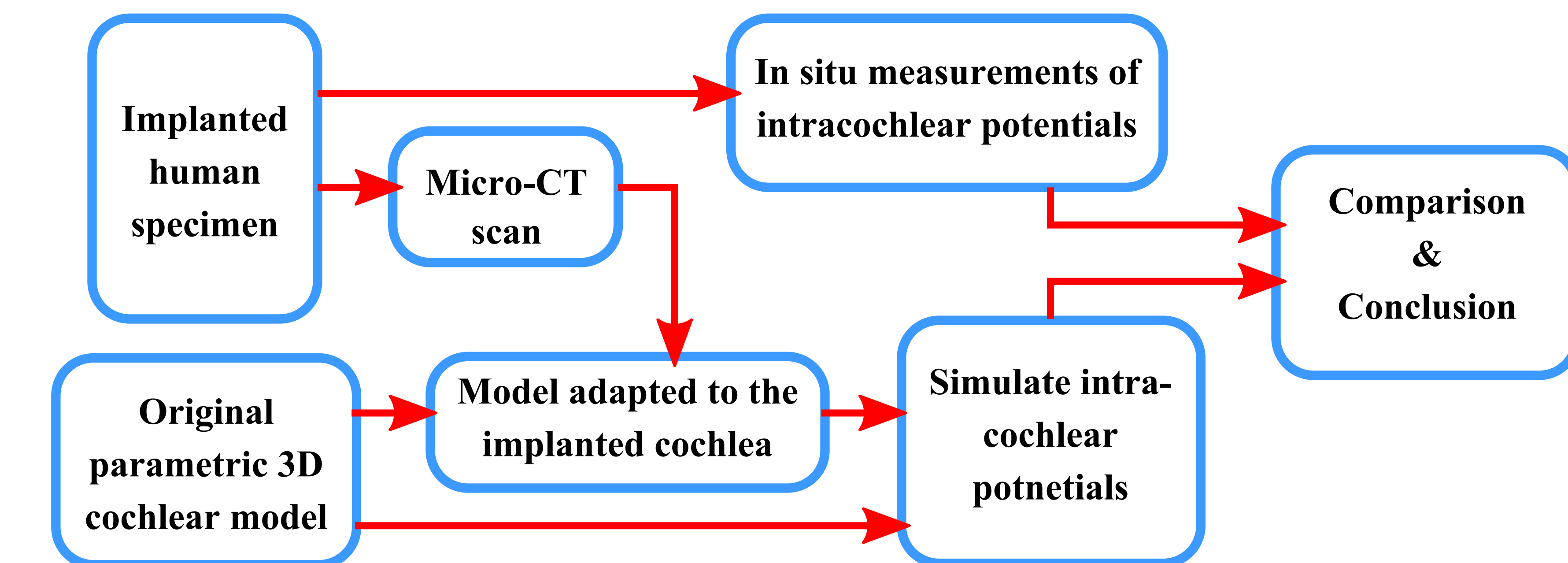

## Acquisition of intracochlear potentials

**Implant:** The human specimen has been implanted with the EVO electrode array and the XP implant system produced by Oticon Medical. 20 cylindrical platinum contacts are placed at a 1.2mm pitch on the electrode array. Another spherical contact ( $d=1.6\text{mm}$ ) has been placed between the skull and the scalp near the implanted cochlea as the reference electrode.

**Stimulation:** Each contact of the EVO electrode array is connected to an independent current source inside XP through a DC blocking capacitor ( $C_b=47\text{nF}$ ). During the experiment, both the monopolar and the bipolar configurations have been used to stimulate the cochlea from all contacts. The stimulation waveform adopted is the biphasic pulse with 1mA amplitude and 120 $\mu\text{s}$  pulse duration.

**Recording:** The contacts were also linked to the input of an analog multiplexer which directs the input signal to the acquisition device. The waveforms were digitalized with 5MHz sampling rate and a minimal amplitude resolution of 2mV/bit.

This design enables the system to record potentials on all contacts, including the working contacts, at different stimulation modes.

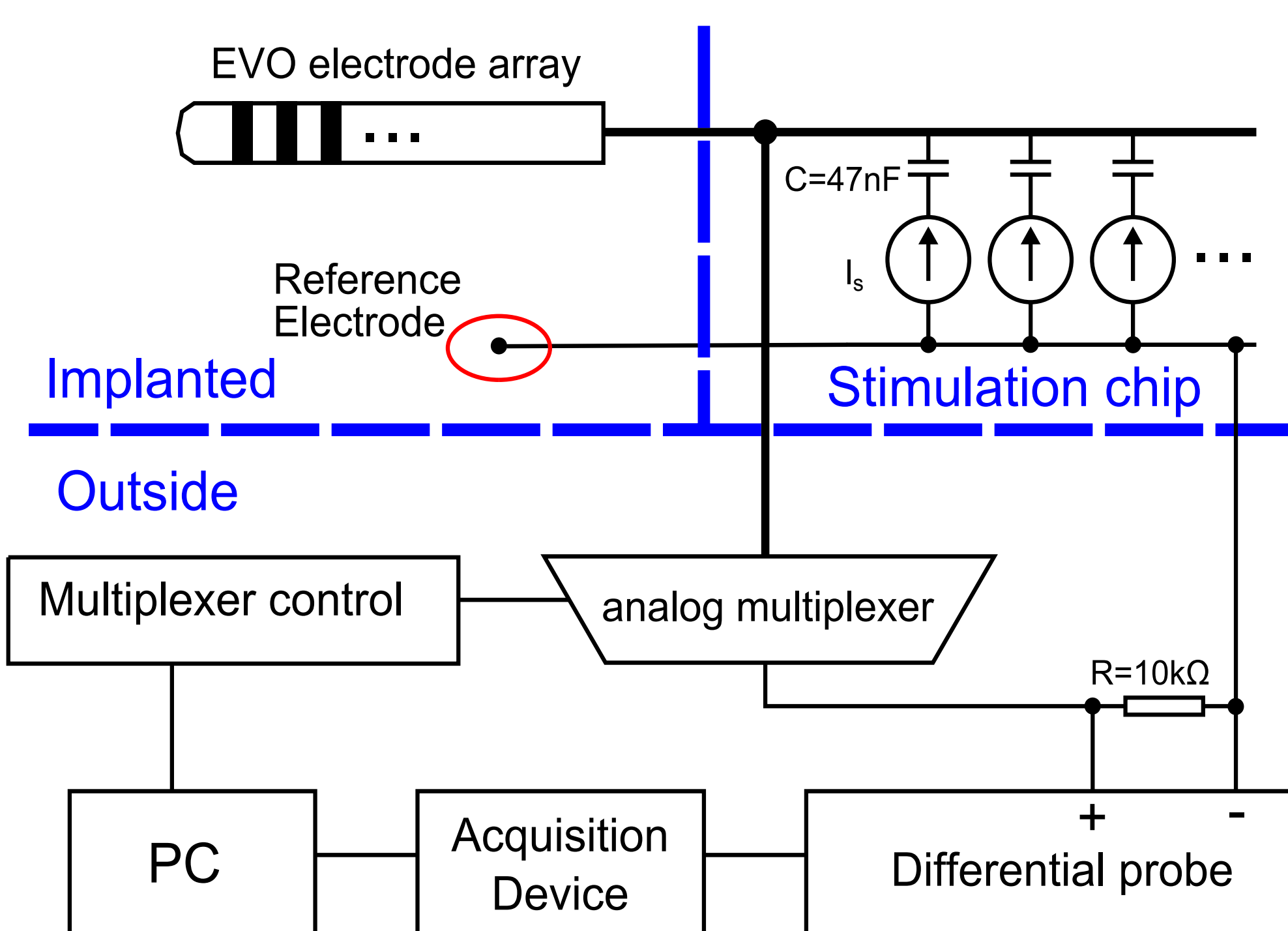

Figure 1. Diagram of the stimulation-recording system[2]

## Geometrical adaptation

The purpose of adaptation is to reflect the anatomical features of the implanted cochlea in the parametric 3D model, thus increasing the precision of the simulation.

Here we extract the geometric information of the cochlea through a **Post operative 3D Micro-CT scan** on the implanted human specimen. The resolution of the scan is 24.8 $\mu\text{m}$  in each direction.

**Cochlear coordinate system**[3]: as the first step of adaptation, a cylindrical coordinate system is placed into the scan data. Figure 2(a) gives the position of the polar axis (yellow arrow) in relation to the implanted electrodes. The image is acquired by projecting the 3D electrode scan onto a plane perpendicular to the longitudinal axis, which is defined by the central axis of the modiolus.

**Parametric cochlear model:** The original 3D cochlear model is defined by a set of parametric equations that describe a generalized cochlear shape[4](snapshot in figure 3). The computation of potential is achieved through the boundary element method implemented in OpenMEEG.

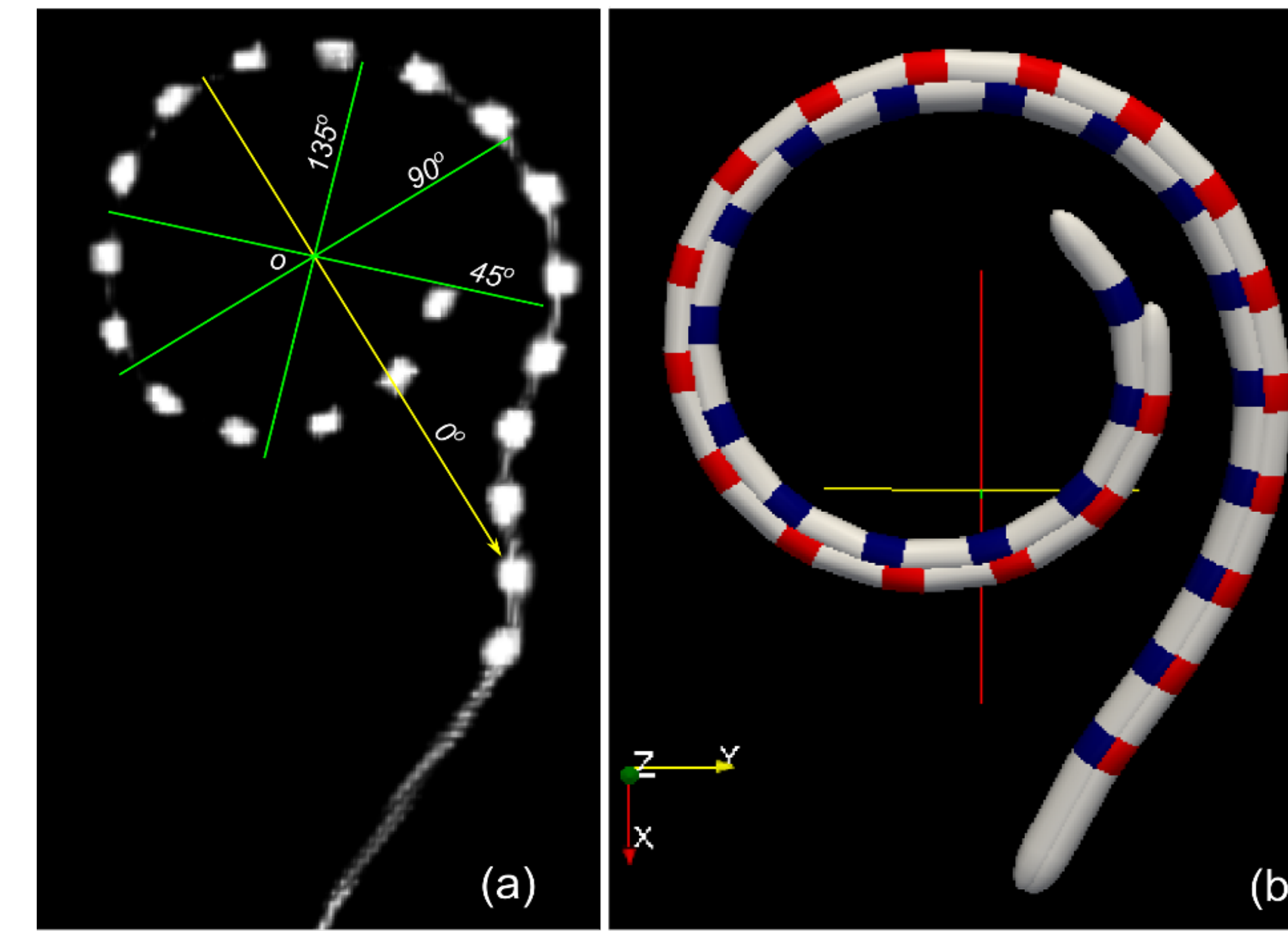

Figure 2. The cochlear coordinate system (a), and the electrode model before (blue) and after (red) adaptation (b).

4 different parameters: the **height**, **width** and **tilt angle** of the scala tympani and the **placement of the electrode array** are used to adapt the original model towards the actual geometry. Their values were extracted from the vertical cross-section images taken at different angular coordinates, as shown by the green lines in figure 2(a). Figure 4 demonstrates those images with the manually segmented scala tympani and scala vestibuli (green circle).

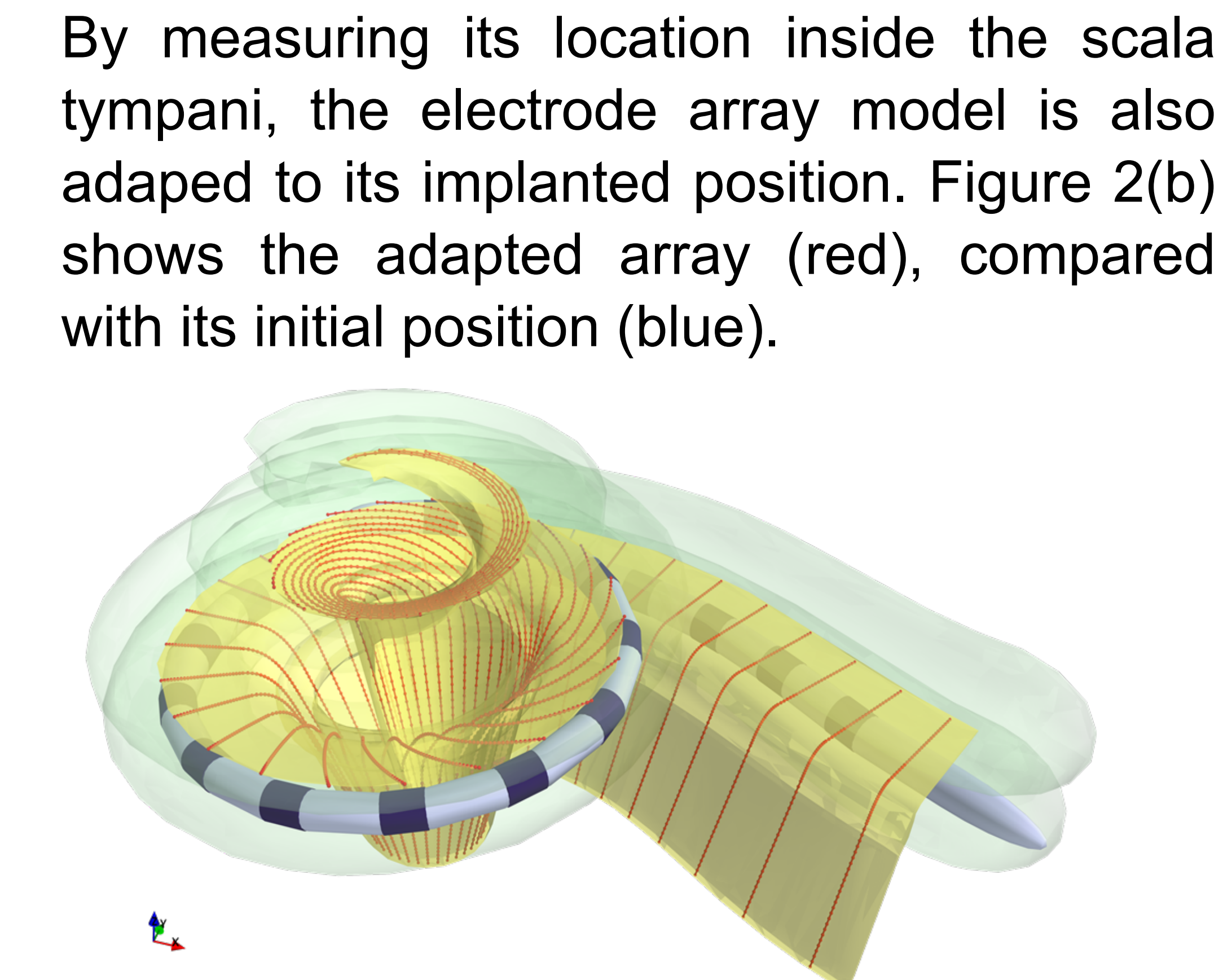

Figure 3. Snapshot of the parametric cochlear model

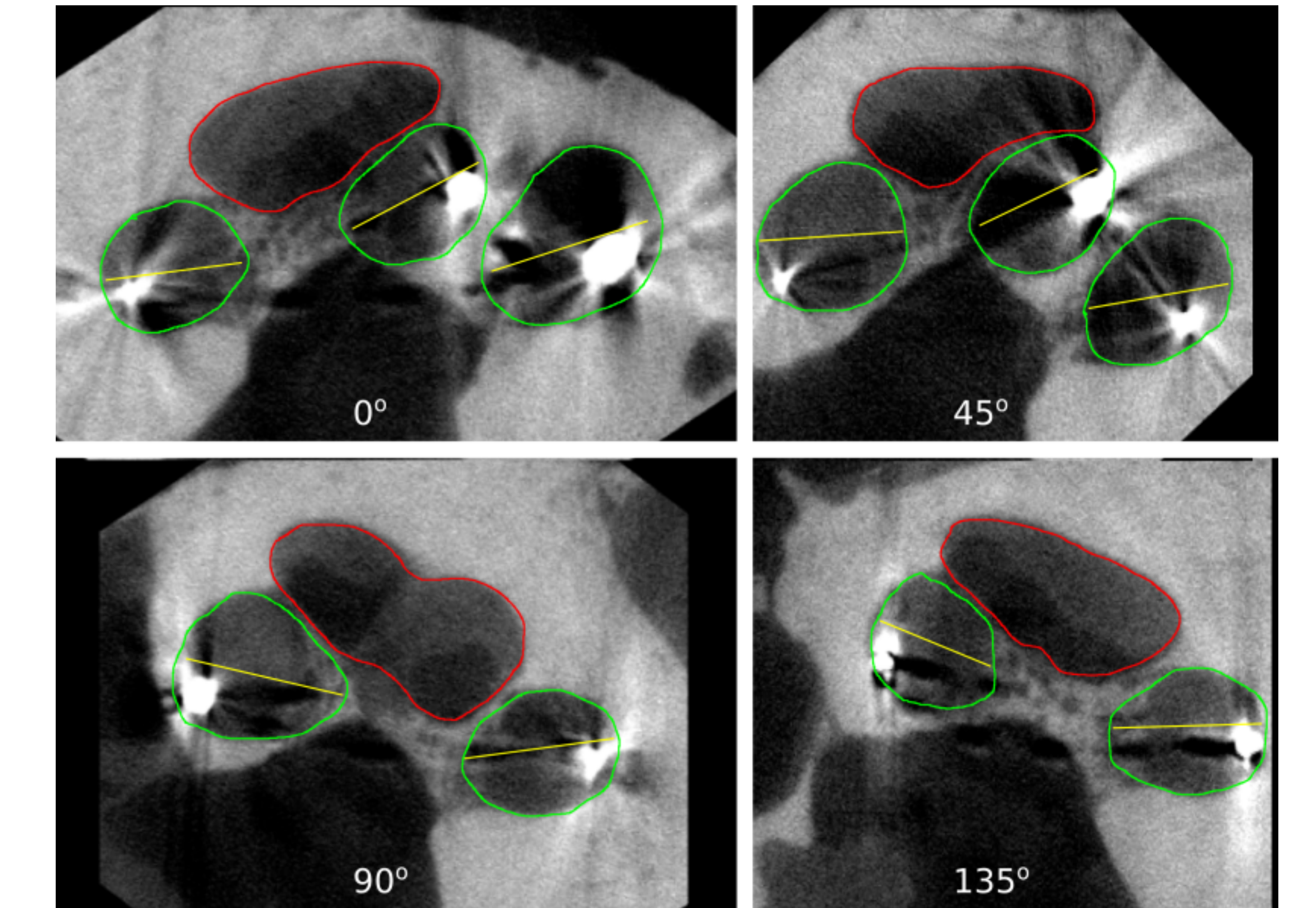

Figure 4. Cross-sections of the cochlear scan at 4 different angular coordinates

## Results & discussion

Figure 5 and 6 each gives the simulation error in monopolar and bipolar mode respectively. The x-axis of the plot is the index of the stimulating electrode while the y-axis is the error computed by the Relative Difference Measure (RDM).

Electrode + geometry indicates both the electrode and the cochlear geometry have been adapted to the micro-CT scan, etc.

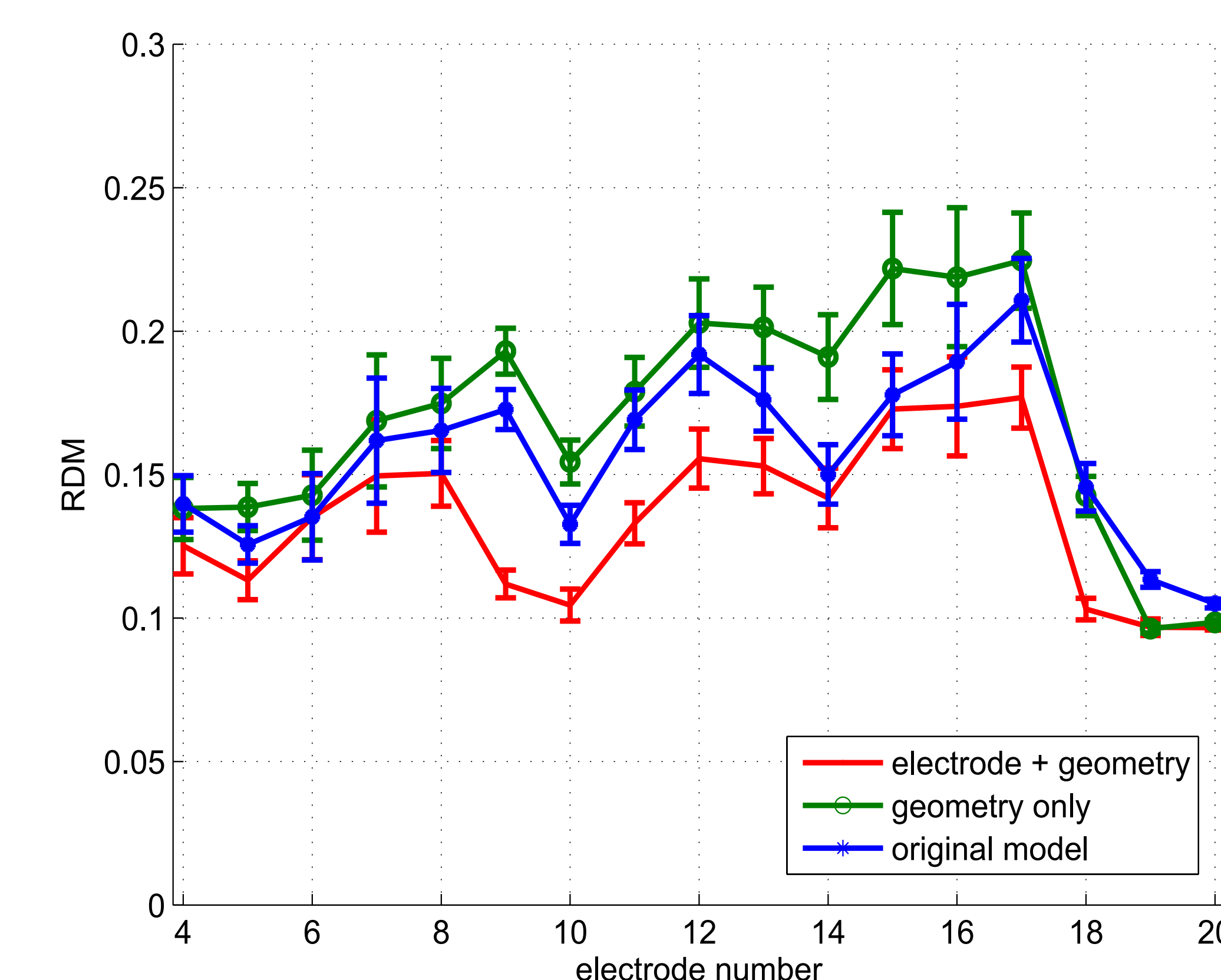

Figure 5. Simulation error under bipolar stimulation mode

In both figure 5 and 6, the models with only the geometrical adaptation give the highest error on average, even more than the models without adaptations. This phenomenon suggests the mismatch between the cochlear shape and the electrode placement is a noticeable source of error.

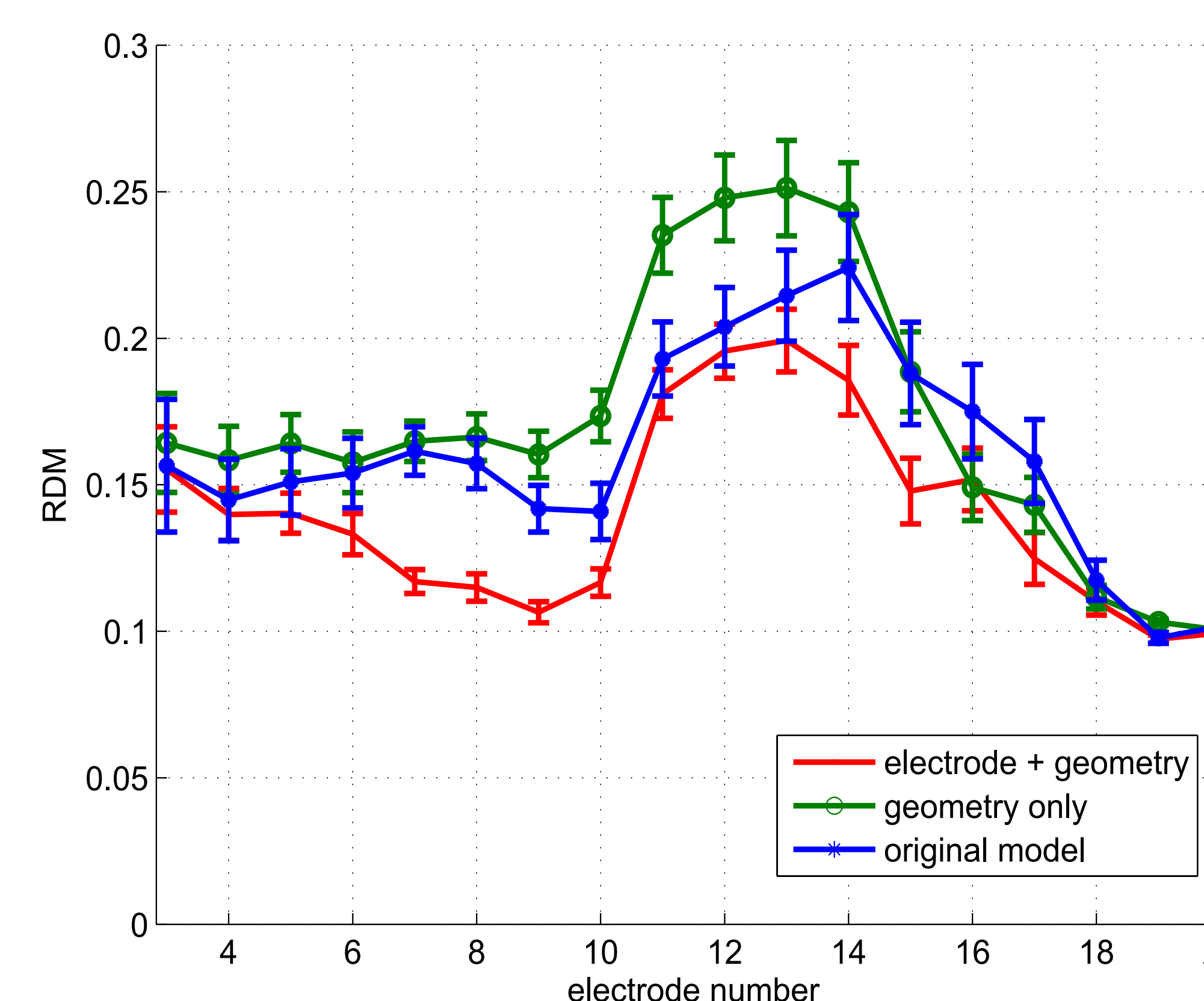

Figure 6. Simulation error under monopolar stimulation mode

The decrease in the simulation error brought by adaptation is more obvious when stimulating from near the middle of the electrode array. This can be explained by the fact that the array does not drift much from its position in the original model at the basal part of the cochlea, while at the apex of the cochlea, the relatively small size of the scala tympani (see figure 7) limits the movement of the implanted array.

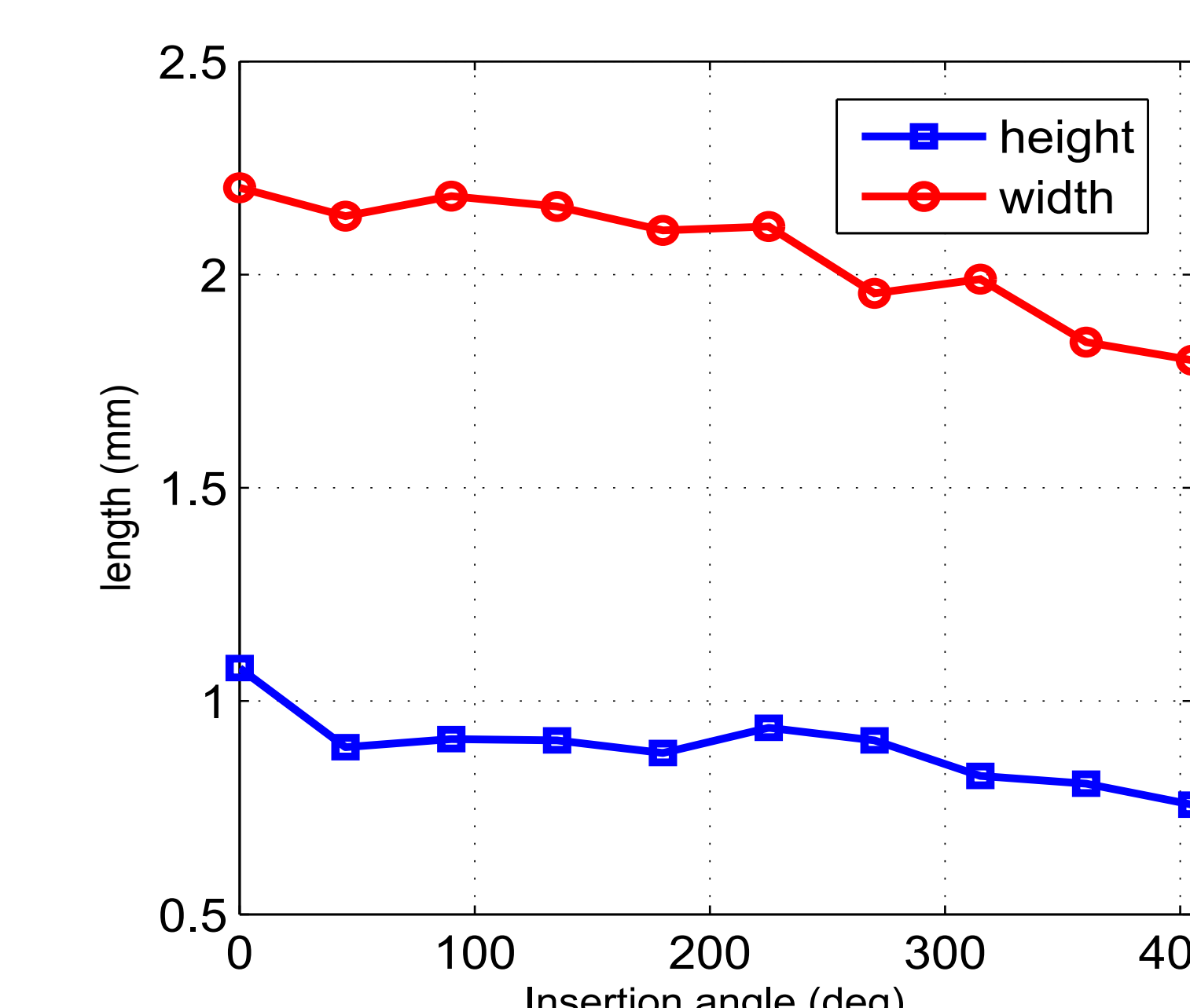

Figure 7. Width and height of the scala vestibuli measured from micro-CT scan

## Conclusion

Compared with a generalized 3D cochlear model, models that have been adapted with subject specific information reduces the error of intracochlear potential simulation, on the premise that the adaptation process takes both the cochlear geometry and the electrode placement into consideration.

## References

- [1] L. Cohen et al. "Improved and simplified methods for specifying positions of the electrode bands of a cochlear implant array", *Otology & Neurotology*, 1996
- [2] K. Dang et al. "In situ validation of a parametric model of electrical field distribution in an implanted cochlea", (manuscript), *IEEE conference on Neural Engineering*, 2015
- [3] B. M. Verbist, M. W. Skinner, L. T. Cohen, P. A. Leake, C. James, C. Bo"ex, T. A. Holden, C. C. Finley, P. S. Roland, J. T. Roland Jr et al., "Consensus panel on a cochlear coordinate system applicable in histological, physiological and radiological studies of the human cochlea," *Otol Neurotol*, vol. 31, no. 5, p. 722, 2010.
- [4] J. Clark et al. "A scalable model for human scala tympani phantoms", *Journal of Medical Devices*, 2011

## Acknowledgements

The research work is supported by Oticon Medical and Association Nationale de la Recherche et de la technologie (ANRT) ( CIFRE N° 2013/0855 )