



HAL
open science

Saturated Feedback Control for an Automated Parallel Parking Assist System

Plamen Petrov, Fawzi Nashashibi

► **To cite this version:**

Plamen Petrov, Fawzi Nashashibi. Saturated Feedback Control for an Automated Parallel Parking Assist System. 13th International Conference on Control, Automation, Robotics and Vision (ICARCV'14), Dec 2014, Singapore, Singapore. hal-01107530

HAL Id: hal-01107530

<https://inria.hal.science/hal-01107530>

Submitted on 20 Jan 2015

HAL is a multi-disciplinary open access archive for the deposit and dissemination of scientific research documents, whether they are published or not. The documents may come from teaching and research institutions in France or abroad, or from public or private research centers.

L'archive ouverte pluridisciplinaire **HAL**, est destinée au dépôt et à la diffusion de documents scientifiques de niveau recherche, publiés ou non, émanant des établissements d'enseignement et de recherche français ou étrangers, des laboratoires publics ou privés.

Saturated Feedback Control for an Automated Parallel Parking Assist System

Plamen Petrov

Faculty of Mechanical Engineering
Technical University of Sofia
Sofia, Bulgaria
ppetrov@tu-sofia.bg

Fawzi Nashashibi

RITS
INRIA – Paris Rocquencourt
Rocquencourt, France
fawzi.nashashibi@inria.fr

Abstract—This paper considers the parallel parking problem of automatic front-wheel steering vehicles. The problem of stabilizing the vehicle at desired position and orientation is seen as an extension of the tracking problem. A saturated control is proposed which achieves quick steering of the system near the desired position of the parking spot with desired orientation and can be successfully used in solving parking problems. In addition, in order to obtain larger area of the starting positions of the vehicle with respect to the parking spot for the first reverse maneuver of the parallel parking, an approach of using saturated control with two different levels of saturation is proposed. The vehicle can be automatically parked by using one or multiple maneuvers, depending on the size of the parking spot. Simulation results are presented to confirm the effectiveness of the proposed control schemes.

Keywords—automated vehicle, saturated control, parallel parking

I. INTRODUCTION

In recent years, there has been significant interest in designing automated vehicles and fully automated operation has been realized through different kinds of maneuvers. Due to the spatial constraints, the parking maneuver may be a difficult task and attracts significant attention from research point of view as well, and from the automobile industry. Beyond the relevance in applications, stabilizing a nonholonomic robotic vehicle at a given posture leads to specific control problems, since point stabilization can not be achieved via smooth or continuous time-invariant feedback control law due to limitations imposed by Brockett's necessary condition [1] for feedback stabilization. Nevertheless, stabilization to a small neighborhood of the origin (practical stabilization) [2], by using time-invariant feedback may be attractive for applications, such as the parking problem. While there has been significant amount of work on controlling the motion of the robot vehicles without bound of the control inputs, there has been much less works on vehicle motion control with input saturations [3,4]. However, in practice, significant issues arise due to limitations on the plant inputs, such as the front wheel steering angle limits, especially in the case of parking maneuvers. In [5], a bang-bang controller based on linear double integrator system is proposed to the problem of automated vehicle steering. An optimal control for route tracking with a bounded-curvature vehicle is proposed in [6].

The parallel parking of a robotic vehicle is one of the complex maneuvers for automation. A car parking control using trajectory tracking controller is presented in [7]. An autonomous parallel parking methodology for Ackerman configured vehicle was reported in [8]. A rule-based controller simulation for an autonomous parallel parking of a car-like robot using laser sensors was given in [9]. In our previous work [10], we presented some results concerning the parking problem of an automatic vehicle by using bang-bang control when the vehicle is moving forward. This strategy is attractive because a quick steering of the system to the origin is achieved. Furthermore, the planning procedure is greatly simplified, since the robot trajectories represent circular arcs. In order to avoid a highly oscillating system near the origin, in addition, a continuous control in a neighborhood of the origin was designed.



Figure 1. The automated CyCab vehicle developed at INRIA equipped with DGPS, odometers and laser range finder.

In this paper, in order to achieve practical stabilization of the closed-loop system in the context of automatic parallel parking of vehicles, we propose a saturated control (SAT control), which is constrained by magnitude, but the control function is continuous. Similarly to bang-bang control, by using SAT control, a quick steering of the system is also achieved, and in the same way, the chattering is avoided. The problem of stabilizing the vehicle is seen as an extension of the tracking problem. The vehicle tracks a straight line passing through the goal point of the parking spot with varying velocity depending of the position of the vehicle with respect to the goal

position. Furthermore, we introduce an approach based on the use of two SAT control functions with different saturation levels, in order to obtain a larger area of the starting configurations of the vehicle (initial position and orientation with respect to the parking spot) for parallel parking. Position and orientation data, which are necessary for feedback control, can be obtained from differential global position system (DGPS), odometers and laser range finder with which the CyCab vehicle developed at INRIA is equipped (Fig. 1).

The rest of the paper is organized as follows: In section II, the design of the SAT control for front-wheel steering automated vehicles is presented. Application of the designed control algorithms to the parallel parking problem is given in Section III. Simulation results are presented in Section IV. Section V concludes the paper.

II. FEEDBACK STEERING CONTROL

A. Vehicle Model

A plan view of the vehicle is shown in Fig. 2. For low speed motion, which is the case of the parking maneuver, a reasonable assumption is that the slip angles of the wheels are zero (the velocity vectors of the wheels are in the direction of the orientation of the wheels) [11] and the wheels roll without lateral sliding. We consider the so called “bicycle model” where the front and rear wheels are replaced by single virtual wheels placed at the mid-points of the front and rear vehicle axles, respectively.

To describe the position and orientation of the vehicle in the plane, we assign the following coordinate frames: $Px_p y_p$ located at the center of the rear wheel axle and stationary with respect to the vehicle body where the x_p axis is along the longitudinal base of the vehicle, and an inertial coordinate frame Fxy in the plane of motion. The coordinates of a reference point P placed at the center of the rear wheel axle, with respect to Fxy , are denoted by (x_p, y_p) . The angle θ is the orientation angle of the vehicle with respect to the frame Fxy . Angle α is the front wheel steering angle. The steering angle is measured with respect to the vehicle body. The longitudinal base the vehicle is denoted by l .

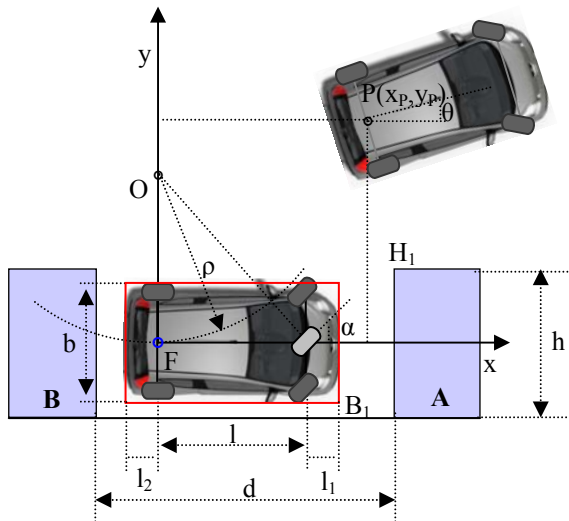

Figure 2. A plan view of the front-wheel steering vehicle.

In this case, the kinematic model of the vehicle in the plane can be described by the following system of nonlinear differential equations

$$\begin{aligned} \dot{x}_p &= v_p \cos \theta \\ \dot{y}_p &= v_p \sin \theta \\ \dot{\theta} &= \frac{v_p}{l} \tan \alpha \end{aligned} \quad (1)$$

where v_p is the vehicle velocity. The front-wheel steering angle α is the control input of the system.

B. Saturated Control

In this paper, we consider a practical stabilization (stabilization to a small neighborhood of the origin) of the vehicle in the parking spot. The problem of stabilizing the vehicle is seen as an extension of the tracking problem. We are interested in moving the vehicle along a straight line passing through the goal point of the parking spot and aligned with the orientation of the spot with varying velocity depending of the position of the robot with respect to the goal position. We assume that the controller for the robot velocity has been already designed.

The design of the saturated path tracking controller, proposed in this paper is based on “high-gain”-type control design [12]. We consider in details the case when the vehicle is moving backward, ($v_p = -|v_p| < 0$), but similar results can be obtained and for forward driving. The vehicle has to track a straight line which for simplicity coincides with the Fx axis of the inertial frame Fxy , (Fig. 2). Consider the second and third equations of (1) with input saturation for the steering angle $|\alpha| \leq \alpha_{\max}$. In that follows, we consider the case when v_p is constant. The control objective is to regulate the state vector $[y_p, \theta]^T$ to zero. Using the following change of input

$$u_s = \frac{\tan \alpha}{l} \quad (2)$$

second and the third equations of system (1) can be written in the form

$$\begin{aligned} \dot{y}_p &= -v_p \sin \theta \\ \dot{\theta} &= -u_s \end{aligned} \quad (3)$$

We propose the following saturated control

$$u_s = u_m \text{sat}(\xi) \quad (4)$$

where

$$\text{sat}(\xi) = \begin{cases} -1 & \text{for } \xi < -1 \\ \xi & \text{for } |\xi| \leq 1 \\ 1 & \text{for } \xi > 1 \end{cases}$$

$$u_m = \text{abs}(u_s)$$

$$\xi = \frac{u}{u_m}$$

$$u = k(e_\theta - k_0 e_y) \quad (5)$$

and $k_0 = cte > 0$, $k = cte > 0$.

Applying the control (4)-(5) to the system (3), that yields a closed-loop system which has an equilibrium point at the origin. To analyze the stability of the closed-loop system, we introduce a change of coordinates as follows

$$z = e_\theta - k_0 e_y. \quad (6)$$

Using (6), the closed-loop system composed of (3), (4), and (5), can be written in the form

$$\begin{aligned} \dot{y}_p &= -v_p \sin(z + k_0 e_y) \\ \dot{z} &= v_p \rho(u) + k_0 v_p \sin(z + k_0 e_y) - v_p u \end{aligned} \quad (7)$$

where

$$\rho(u) = u - u_m \text{sat}(\xi). \quad (8)$$

We consider the following Lyapunov function candidate

$$V = \frac{1}{2} (k_0^2 e_y^2 + z^2). \quad (9)$$

Using (7), for the derivative of V , we obtain

$$\dot{V} = -k_0^3 v_p \text{Re}_y^2 - k v_p z^2 + v_p z \rho(u) + k_0 v_p R z^2 \quad (10)$$

where

$$R = \frac{\sin(z + k_0 e_y)}{z + k_0 e_y}. \quad (11)$$

By using the fact that

$$\forall |u| \leq u_m (1 + \Delta) \rightarrow |\rho(u)| \leq \frac{\Delta}{1 + \Delta} |u| \quad (12)$$

we have

$$\dot{V} \leq -k_0^3 v_p \text{Re}_y^2 - v_p z^2 \frac{k - k_0 R (1 + \Delta)}{1 + \Delta}. \quad (13)$$

Since $0 < R \leq 1$, by choosing

$$k \geq k^* = k_0 (1 + \Delta) \quad (14)$$

we obtain that \dot{V} is negative definite. Hence, the proposed control law (4)-(5) achieves local asymptotic stability of the equilibrium point of the closed-loop system. This result could be generalized for a system with time-varying vehicle velocity, when v_p together with its derivative are bounded and also the following inequalities hold: $0 < v_{pmin} \leq |v_p(t)| \leq v_{pmax}$.

III. THE PARALLEL PARKING MANEUVER

In this paper, we consider that the parking spot is available and we don't need to localize this place. We also assume rectangular form of the automated vehicle in the plane as shown in Fig. 2. In order to synthesize the parallel parking maneuver, we consider the following parameters of the vehicle and the parking spot (Fig. 2):

- l – distance between the front and rear wheel axles (longitudinal base of the vehicle).

- b – (lateral) wheel base of the vehicle.
- $l1$ – distance between the front wheel axle and the front bumper of the vehicle.
- $l2$ – distance between the rear wheel axle and the rear bumper of the vehicle.
- ρ – minimum turning radius of the vehicle.
- d – length of the parking spot.
- h – width of the parking spot.

The point O is the Instantaneous Center of Rotation (ICR) for the vehicle when the steering angle α takes constant value α_{max} . For simplicity of exposition, we consider that the inertial reference frame Fxy is located at the goal position of the parking spot and the Fx axis is oriented in direction of the parking place. The rectangles A and B which determined the parking spot are considered as obstacles.

A. Parallel Parking in One Maneuver

In order to execute a reverse parallel parking in one collision-free maneuver, there are several conditions that have to be fulfilled. Using geometric arguments, the minimum length of the parking spot (Fig. 2) is expressed through the following equation

$$d_{min} = l + l_1 + d_{1min} \quad (15)$$

where

$$d_{1min} = \text{sqr}t \left[R_{min}^2 - \left(\rho - \frac{h}{2} \right)^2 \right] \quad (16)$$

$$R_{min} = \text{sqr}t \left[(l + l_1)^2 + \left(\rho + \frac{b}{2} \right)^2 \right]. \quad (17)$$

Based on the SAT control proposed in Section II, the parallel parking maneuver can be executed in one maneuver by tracking the Fx axis of the inertial frame Fxy with velocity depending on the distance of the vehicle with respect to the Fy axis. The velocity profile of the vehicle is determined from the following expressions

$$\begin{aligned} \text{if } x_p \geq x_p^{dist} \\ v_p &= -\text{abs}(v_p^{cte}) (1 - \exp(-\tau)) \\ \text{else} \\ v_p &= -\text{abs}(v_p^{cte}) (x_p / x_p^{dist}) \end{aligned} \quad (18)$$

where $-\text{abs}(v_p^{cte})$ a desired constant value of the vehicle velocity during backward motion; x_p^{dist} is a prescribed distance from the Fy axis; τ is positive constant.

When the magnitude of the front wheel steering angle is constrained by only one value, i.e., the saturated control has one level of saturation, (a saturated control with two levels of saturation will be considered in the next sub-section), the vehicle must be initially positioned on a circle which is tangent to the circle with centre O with the same radius. When the two

circles are identical, using the SAT control, the vehicle reverse path takes the form of S -shape, which ends very close to the goal position F and is very similar to the composition of two arcs.

B. Parallel Parking in Multiple Maneuvers

If the length of the parking spot is less than d_{min} given by (15), but exceeds the robot length ($l + l_1 + l_2$), multiple maneuvers have to be performed in order to reach the goal position F with desired orientation, (a parked vehicle aligned with the Fx axis of Fxy). The approach proposed in this paper, is stated as follows: By applying a first reverse maneuver, we want to reach the goal point F with the reference point P of the vehicle by tracking the x_S -axis of a shifted coordinate system Sx_Sy_S , which center S coincides with the center F of Fxy , and the Sx_S axis is oriented by an angle φ_S with respect to Fx (Fig. 3).

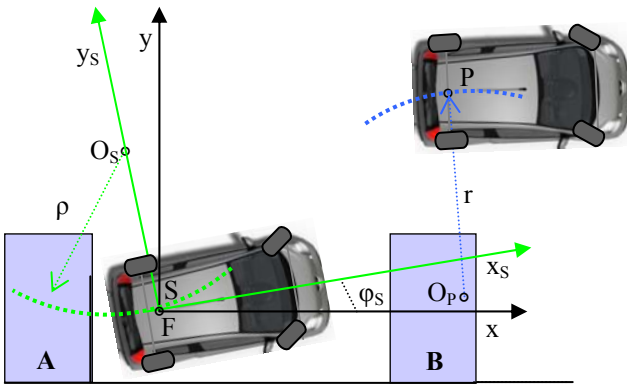

Figure 3. Parallel parking in multiple maneuvers: the first reverse maneuver with two different levels of saturation of the SAT control.

The angle φ_S is calculated before the start of the parking maneuver, and is a function of R_{min} (17), the parameters of the parking spot and the vehicle. Again, if the vehicle is initially positioned on a circle which is tangent to the circle with center O_S (with identical radius), by applying the SAT control (3)-(4) and a profile of the vehicle velocity given in (18), in the end of the first maneuver, the reference point P of the vehicle is positioned at point F and oriented along the x_S -axis. After that, by tracking the Fx -axis of the frame Fxy , the vehicle reaches the goal point F with a good orientation along the Fx axis by applying consecutive forward and backward maneuvers with prescribed distance from the obstacles A and B into the parking spot (Fig. 3).

In order to obtain a larger area of the starting configurations of the vehicle for parallel parking, in this paper, we propose an approach of using saturated control (4)-(5) with two different levels of saturation (Fig. 3). Using the initial position and orientation of the vehicle, the radius r of the first circle O_P (Fig. 3) and the coordinates of the tangent point between the circles with radius ρ and r , respectively, are first determined. The vehicle starts from the initial position with saturation level of the control corresponding to the radius r of the first circle with center O_P . When the tangent point is reached, the steering angles of the robot turn in the opposite direction, but with saturation level for the control corresponding to the radius of the circle with center O_S . It is to notice that in general, the two

tangent circles are not identical. Therefore, the maximum values of the steering angles corresponding to each of the two arcs are also different.

IV. SIMULATION RESULTS

Simulation results are presented by using MATLAB to illustrate the performance of the proposed saturated controller for automatic parking of vehicles. The dimensions of the vehicle were chosen to be: length - $3.5m$; width - $2m$; distance between the front/rear wheel axle and the front/rear bumper $l_1 = l_2 = 0.5m$; wheelbase $l = 2.5m$.

A. Simulations for Parallel Parking in One Maneuver

For parallel parking in one maneuver, the vehicle is moving backward. For the simulations, the maximum steering angle of the front wheels was chosen to be $|\alpha_{max}| = 0.6435rad$. The parking spot must satisfy the conditions (15)-(17) to ensure that there is enough space to accomplish the parking maneuver in one step. For this end, the dimensions of the parking spot were chosen to be: length $d = l_2 + d_1 = 6m$ and width $h = 2.5m$. The vehicle is initially positioned with coordinates and orientation with respect to the inertial frame Fxy as follows: $x_{p0} = 5.77m$, $y_{p0} = 3.33m$, and orientation $\theta_0 = 0rad$. The maximum value of the vehicle velocity during the parking maneuver was chosen to be: $abs(v_p^{cte}) = 0.3 m/s$. The planar path of the vehicle using the SAT control proposed in Section II and animation of the parking maneuver are presented in Fig. 4.

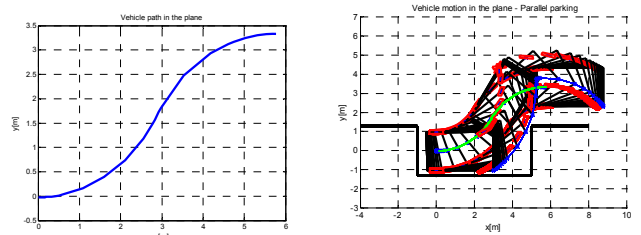

Figure 4. Parallel parking in one maneuver using SAT control: Planar path of the vehicle and animation of the parking maneuver.

Evolution in time of the error coordinates is presented in Fig. 5. The vehicle reaches the goal position $F(0,0)$ with small lateral error of $0.024m$ and orientation error of $0.0043rad$, which is quite acceptable from a practical point of view.

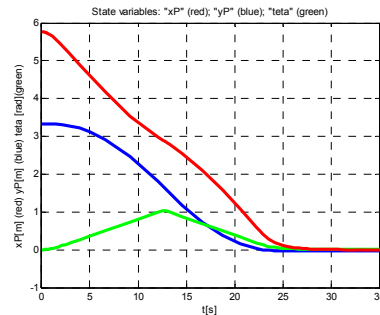

Figure 5. Parallel parking in one maneuver: Evolution in time of the error coordinates: $x_P(t)$ (red line), $y_P(t)$ (blue line) and $\theta(t)$ (green line).

Fig. 6 shows evolution in time of the vehicle velocity during the parking maneuver in one step. The velocity profile

of the vehicle can be divided into three segments: the velocity is initially exponentially increasing to reach a desired constant value. After that, the vehicle is moving at a constant velocity. The last part of the maneuver is at decreasing velocity, depending on the distance between the current position of the vehicle and the goal position in the parking spot.

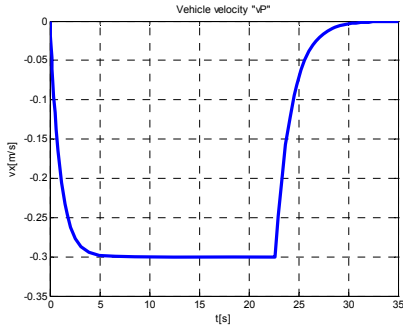

Figure 6. Parallel parking in one maneuver: Evolution in time of the vehicle velocity.

Evolution in time of the front-wheel steering angle by using saturated control is shown in Fig. 7.

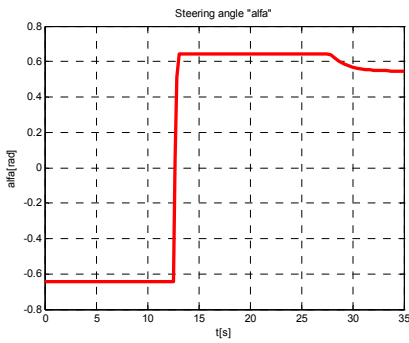

Figure 7. Parallel parking in one maneuver: Evolution in time of the front wheel steering angle.

As seen from Fig. 7, the time plot of the steering angle using SAT control is continuous, which is the main advantage of this type of control compared to the discontinuous bang-bang control. In this way the chattering (unwanted vibration of the steering wheels) is avoided.

B. Simulations for Parallel Parking in Multiple Maneuvers

For the simulations of automatic parking in multiple maneuvers, the dimensions of the parking spot were chosen to be: length - $d = l_2 + d_1 = 5m$ and width - $h = 2.5m$. The parking spot does not satisfy the conditions given by (15)-(17) for parking in one maneuver, but the length of the spot d is greater than the vehicle length. The number of maneuvers is not exactly known in advance, and depends on the desired prescribed position and orientation error of the vehicle with respect to the goal configuration in the parking spot, as well the initial position and orientation of the vehicle. In practice, the parallel parking is performed with accuracy, which is sufficient from practical point of view, in minimum three and maximum seven consecutive maneuvers for parking places which satisfy the minimal length of the parking space for safety parking [9].

Simulations with different initial conditions with respect to the inertial coordinate frame Fxy attached to the goal position of the parking spot were performed based on the proposed approach of using saturated control (4)-(5) with two different levels of saturation. Simulations were carried out with five consecutive maneuvers. During the first reverse maneuver, the vehicle reaches the goal point F by tracking a line, which is defined by angle $\varphi_S = 0.27rad$ with respect to the Fx axis of the reference frame Fxy , attached to the parking spot. The value of φ_S is a function of R_{min} (17), the parameters of the parking spot and the vehicle, and is not dependent on the vehicle starting position and orientation. The maximum value of the vehicle velocity during the first backward maneuver was chosen to be $abs(v_P^{cte}) = 0.3 m/s$, and after that, $abs(v_P^{cte}) = 0.15 m/s$ for each consecutive maneuver. Planar path of the vehicle and animation of the parking maneuver for two different initial conditions are shown in Fig. 8 and Fig. 9, respectively.

For the simulations, presented in Fig. 8, the initial position of the vehicle with respect to the inertial coordinate frame Fxy attached to the goal position of the parking space was chosen to be $(7m, 3.83m)$ and orientation $-0.2rad$. With respect to the initial configuration, the first level of saturation was calculated to be $0.49rad$. The second level of saturation was the maximum steering angle of the front wheels $|\alpha_{max}| = 0.6435rad$, as in the parallel parking in one maneuver. The vehicle executes five consecutive maneuvers (backward – forward – backward – forward – backward), until reaching the goal configuration with lateral error of $0.01m$ and orientation error of $-0.0028rad$.

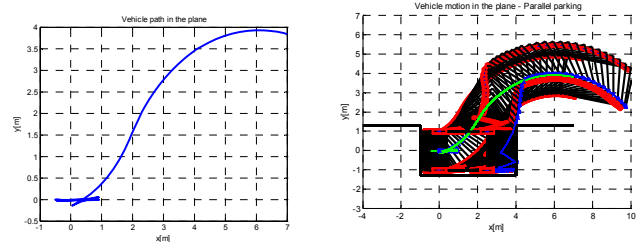

Figure 8. Parallel parking in multiple maneuvers using SAT control: Planar path of the vehicle and animation of the parking maneuver.

For the simulations, presented in Fig. 9, the initial position of the vehicle with respect to the inertial coordinate frame Fxy attached to the goal position of the parking space was chosen to be $(6m, 3.83m)$ and orientation $+0.2rad$.

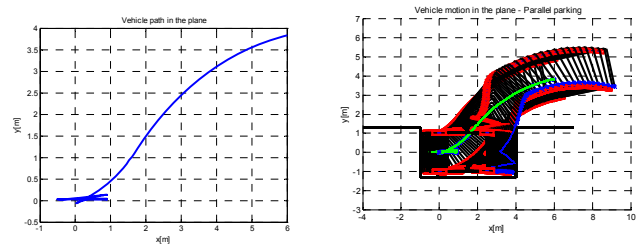

Figure 9. Parallel parking in multiple maneuvers using SAT control: Planar path of the vehicle and animation of the parking maneuver.

With respect to the starting position and orientation, the first level of saturation was calculated to be $0.337rad$. The second level of saturation was the maximum steering angle of the front wheels $|\alpha_{max}| = 0.6435rad$, as in the parallel parking in one maneuver. The vehicle executes five consecutive maneuvers (backward – forward – backward – forward – backward), until reaching the goal configuration with lateral error of $0.02m$ and orientation error of $0.013rad$. Hence, by using saturated control with two different levels of saturation, it is possible to obtain a considerable large area for starting positions of the vehicle with respect to the parking spot to perform the parallel parking maneuver. The simulation results confirm the validity of the proposed SAT controller.

V. CONCLUSION

In this paper, the parallel parking problem of front-wheel automated vehicles is considered. The problem of practical stabilization the vehicle is seen as an extension of the tracking problem. A saturated feedback control has been proposed. The saturated control has an advantage that the control function is continuous and the chattering is avoided. It has been demonstrated that by using SAT control, a quick steering of the system near to the desired position of the parking spot is possible and the SAT control can be successfully used in order to solve the parking problem. An approach of using SAT control with two different levels of saturation has been also proposed and in this way, a larger area of the starting positions of the vehicle with respect to the parking spot has been achieved. The vehicle can be automatically parked by using one or multiple maneuvers, depending on the size of the parking space. Simulation results confirm the effectiveness of the proposed control schemes. Our future work will address the

implementation of the control algorithms on an experimental automatic vehicle developed at INRIA (Fig. 1).

REFERENCES

- [1] R. Brockett, Asymptotic stability and feedback stabilization, Available at <http://hrl.harvard.edu/publications/brockett83asymptotic.pdf>.
- [2] P. Petrov, J. de Lafontaine, and M. Tetreault, “Hybrid feedback control for the parking problem of a load-haul-dump mine vehicle”, Proc. IEEE/RSJ IROS, 1998, pp. 1907-1912.
- [3] N. Enache, S. Guegan, F. Desnoyer, and H. Vorobieva, Lane keeping and lane departure avoidance by rear wheels steering, Proc. Int. V. Symposium, 2012, pp. 359-364.
- [4] Z.-P. Jiang, E. Lefeber, H. Nijmeijer, Saturated stabilization and tracking of a nonholonomic mobile robot, Systems&Control Letters, pp. 327-332, Vol. 42, 2001.
- [5] C. George and R. O’Brien, “Vehicle lateral control using double integrator control strategy”, Proc. Southeastern Symp. Syst. Theory, 2004, pp. 398-400.
- [6] P. Souares, A. Ballucchi, and A. Bicchi, “Optimal feedback control for route tracking with a bounded-curvature vehicle”, Proc. IEEE Int. Conf. Rob. Automation, 2000, pp. 2473-2478.
- [7] K. Lee, D. Kim, W. Chung, H. Chang, P. Yoon, Car parking control using a trajectory tracking controller, Proc. SICE-ICASE Int. J. Conference, 2006, pp. 2058-2063.
- [8] A. Gupta, R. Divekar, Autonomous parallel parking methodology for Ackerman configured vehicle, ACEEE Int. J. Contr. Syst. Instrumentation, pp. 34-39, vol. 2, No 2, 2011.
- [9] K. Andrade, A. Hernandez, M. Becker, A rule-based controller simulation for an autonomous parallel parking of a car-like robot using laser sensors, ABCM Sym. Series and Mechatronics, 2012, pp. 1042-1051.
- [10] P. Petrov, C. Boussard, S. Ammoun, F. Nashashibi, A hybrid control for automatic docking of electric vehicles for recharging, IEEE Int. Conf. Rob. Automation, 2012, pp. 2966-2971.
- [11] R. Rajamani, Vehicle dynamics and control, Second edition, Springer, 2012.
- [12] R. Sepulchre, M. Jankovic, and P. Kokotovic, Constructive nonlinear control, Springer-Verlag London, 1997.