



**HAL**  
open science

## **REMOVEDEBRIS: An EU low cost demonstration mission to test ADR technologies**

Vaios Lappas, Jason Forshaw, Lourens Visagie, Aurélien Pisseloup, Thierry Salmon, Eric Joffre, Thomas Chabot, Ingo Retat, Robert Axthelm, Simon Barraclough, et al.

► **To cite this version:**

Vaios Lappas, Jason Forshaw, Lourens Visagie, Aurélien Pisseloup, Thierry Salmon, et al.. REMOVEDEBRIS: An EU low cost demonstration mission to test ADR technologies. International Astronautical Congress, Sep 2014, Toronto, Canada. hal-01088961

**HAL Id: hal-01088961**

**<https://inria.hal.science/hal-01088961v1>**

Submitted on 29 Nov 2014

**HAL** is a multi-disciplinary open access archive for the deposit and dissemination of scientific research documents, whether they are published or not. The documents may come from teaching and research institutions in France or abroad, or from public or private research centers.

L'archive ouverte pluridisciplinaire **HAL**, est destinée au dépôt et à la diffusion de documents scientifiques de niveau recherche, publiés ou non, émanant des établissements d'enseignement et de recherche français ou étrangers, des laboratoires publics ou privés.

# REMOVEDEBRIS: AN EU LOW COST DEMONSTRATION MISSION TO TEST ADR TECHNOLOGIES

Vaios J. Lappas<sup>1</sup>, Jason L. Forshaw<sup>2,\*</sup>, Lourens Visagie

*Surrey Space Centre, Department of Electronic Engineering, University of Surrey, Guildford, UK*

Aurélien Pisseloup<sup>a</sup>, Thierry Salmon<sup>a</sup>, Eric Joffre<sup>b</sup>, Thomas Chabot<sup>c</sup>, Ingo Retat<sup>d</sup>, Robert Axthelm<sup>d</sup>, Simon Barraclough<sup>e</sup>, Andrew Ratcliffe<sup>e</sup>

*Airbus Defence and Space (DS): <sup>a</sup> Bordeaux, France; <sup>b</sup> Les Mureaux, France; <sup>c</sup> Toulouse, France; <sup>d</sup> Bremen, Germany; <sup>e</sup> Stevenage, UK*

Andy Bradford, Haval Kadhem, Nimal Navarathinam

*Surrey Satellite Technology Limited (SSTL), Guildford, UK*

Jeroen Rotteveel<sup>f</sup>, Cesar Bernal<sup>f</sup>, François Chaumette<sup>g</sup>, Alexandre Pollini<sup>h</sup>, Willem H. Steyn<sup>i</sup>

*<sup>f</sup> Innovative Solutions In Space (ISIS), Netherlands; <sup>g</sup> Inria, France; <sup>h</sup> CSEM, Switzerland; <sup>i</sup> ESL, Stellenbosch University, South Africa*

## ABSTRACT

RemoveDEBRIS is aimed at performing key Active Debris Removal (ADR) technology demonstrations (e.g capture, deorbiting) representative of an operational scenario during a low-cost mission using novel key technologies for ADR. The project is based on and aimed at contributing to global European ADR roadmaps. A microsatellite called here RemoveSAT, will release, capture and deorbit two space debris targets, called DebrisATs, in sequence using various rendezvous, capture and deorbiting technologies thus demonstrating in orbit, key ADR technologies for future missions in what promises to be the first ADR technology mission internationally. The debris objects themselves in this case will be released by the main satellite with subsequent recapture. Although this is not a fully-edged ADR mission, the project is an important step towards a fully operational ADR mission. The ultimate goal of this activity is to protect space assets from space debris and to minimize the collision risk of current and future space missions as the FP7 call for space calls for. The mission proposed in this project and the subsequent technology developments, is a vital prerequisite to achieve this ultimate goal of a cleaner Earth orbital environment. The mission proposed by the RemoveDEBRIS project will be such a demonstration mission - the world's first, and perhaps the most important demonstration of ADR to date - and the technologies that will be developed under the project have been strategically selected for their importance in future ADR activities.

*Keywords:* debris removal, ADR, deorbiting, net, harpoon, vision-based navigation, dragsail

## I. INTRODUCTION

REMOVEDEBRIS is a low cost €11.3 M mission aiming to perform key Active Debris Removal (ADR) technology demonstrations including the use of a net, a harpoon, vision-based navigation and a dragsail in a realistic space operational environment, due for launch in 2016. For the purposes of the mission cubesats are ejected then used as targets instead of real space debris, which is an important step towards a fully operational ADR mission. This paper presents an update on the

preliminary design for the RemoveDEBRIS mission from [1], which is currently progressing through its design phases.

The project consortium partners with their responsibilities are given in Table 1.

### 1.1. Literature

In the field of ADR, there are a wide range of conceptual studies. ESA has produced a range of CleanSpace roadmaps, two of which focus on (a) space debris mitigation and (b) technologies for space debris remediation. ESA's service orientated ADR (SOADR) design phases involved the analysis of a mission that could remove very heavy debris from orbit examining both the technical challenges and the business aspects of multiple ADR missions [2, 3, 4]. ESA has conducted industrial phase-A studies, as well as internal exercises as part of the 'e.DeOrbit' programme, an element of the agency CleanSpace initiative [5]. ESA's Satellite Servicing Building Blocks (SBB)

\*Corresponding Author. Tel.: +44 (0)1483 68 6307

Email addresses: v.lappas@surrey.ac.uk ,

j.forshaw@surrey.ac.uk

URL: www.surrey.ac.uk/ssc/

<sup>1</sup>Principal Investigator, Professor of Space Vehicle Control

<sup>2</sup>Consortium Project Manager, Research Fellow (Spacecraft and GNC)

Table 1: **RemoveDebris Consortium Partners.** \*electric propulsion, †vision-based navigation

Partner	Responsibility
SSC (Surrey Space Centre)	Project management, cubesats, EP*, dragsail
SSTL	Platform technical lead, operations
Airbus DS Germany	Net
Airbus DS France	Mission and systems technical lead, VBN†
Airbus DS UK	Harpoon
ISIS	Cubesat deployers
CSEM	LiDAR camera
Inria	VBN algorithms
Stellenbosch University	Cubesat avionics

study originally examined remote maintenance of geostationary telecommunications satellites using a robotic arm [6]. Aviospace have been involved with some ADR studies. The Capture and De-orbiting Technologies (CADET) study examined attitude estimation and non-cooperative approach using a visual and infra-red system. Airbus’s and Aviospace’s Heavy Active Debris Removal (HADR) study examined trade-offs for different ADR technologies, especially including flexible link capture systems.

In addition to the various conceptual studies, a range of missions are planning to test specific ADR technologies. CNES, the French space agency, has a wide interest in debris removal with the OTV (Orbital Transfer Vehicle) programme which focuses on the removal of large pieces of space debris between now and 2020 [7]. Another mission is DLR’s (German space agency) DEOS (Deutsche Orbital Servicing Mission) that aims to rendezvous with a non-cooperative and tumbling spacecraft by means of a robotic manipulator system accommodated on a servicing satellite [8]. The mission is currently at its Phase B (CDR) level of design. CleanSpace One, a collaboration with EPFL and Swiss Space Systems (S3) and a €12.4 M mission, aims to use microsattellites with a robotic arm to demonstrate ADR technologies [9].

Among research programmes from major space agencies, there is also a range of smaller subsets of ADR literature. Chamot at MIT and EPFL has considered the design of three distinct architectures for debris removal depending on how reusable the chaser vehicle is [10]. The ion-beam shepherd is a potential debris removal solution that has been discussed extensively [11]. In addition, a focus on tether dynamics between chaser and target is becoming a wider area of interest [3, 12, 13].

As mentioned, robotic arms have been considered in several past studies. Airbus DS has spent significant resources in the design of both net [14] and harpoon demonstrators for use in space, which are alternatives to the robotic arm. The net, in particular, is considered by some studies to be the most robust method for debris removal, requiring the least knowledge about the target object [3]. The RemoveDEBRIS mission aims to demonstrate these technologies for the first time in space.

## 1.2. Paper Structure

Section II details the mission and systems engineering aspects giving information on the primary experiments. It also gives information on orbit selection and deorbiting times. Section III outlines the high level design of the platform. Section IV explains the three cubesats in the mission. Section V details the individual payload design. Section VI considers key regulatory issues for debris removal. Finally, Section VII concludes the paper and outlines key contributions to the field.

## II. MISSION

### II.1. In-orbit Demonstrations

This section details the several in-orbit demonstrations in the mission. The three primary experiments are performed sequentially; with data from each being downloaded before the commencement of the next experiment. There is expected to be 40 weeks of mission operations.

#### II.1.1. Net Experiment

The net scenario is shown in Figure 1 and is designed to help mature net capture technology in space. In this experiment, initially the first cubesat (net), DS-1, is ejected by the platform at a low velocity ( $\sim 0.05m/s$ ). DS-1 proceeds to inflate a balloon which, as well as acting as a deorbiting technology, provides a larger target area. A net from the platform is then ejected at the balloon. Once the net hits the target, deployment masses at the end of the net wrap around and entangle the target and motor driven winches reel in the neck of the net preventing re-opening of the net. The cubesat is then left to deorbit at an accelerated rate due to the large surface area of the balloon.

#### II.1.2. Harpoon Experiment

The harpoon scenario is shown in Figure 2. In this experiment, the second cubesat (harpoon), DS-2, is ejected by the platform at a low velocity. Shortly after ejection, the cubesat releases target panels to increase the target surface area. The platform GNC system aligns the harpoon with the centre of the cubesat then fires the harpoon. The harpoon is designed with a flip-out locking mechanism that prevents the tether from pulling out of the cubesat. The cubesat is then left to deorbit.

#### II.1.3. VBN Experiment

The VBN experiment is shown in Figure 3. In this experiment, the third cubesat (harpoon), DS-3, is ejected by the platform. The VBN system (including LiDAR) uses the previous net and harpoon experiments to calibrate itself. A series of manoeuvres are then undertaken allowing the VBN system and supervision cameras to collect data and imagery which are later post-processed on ground.

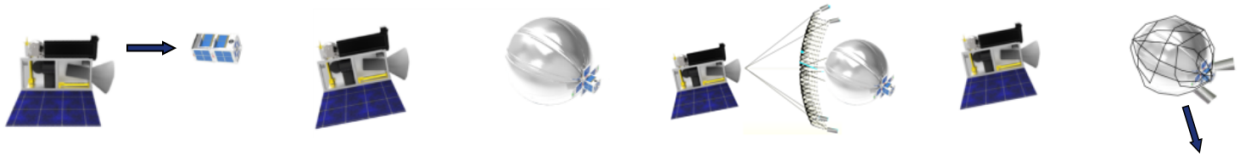

Fig. 1: **Net Experiment**. This figure shows the sequence in the net experiment: (a) cubesat ejection, (b) balloon inflation, (c) net capture, (d) deorbiting.

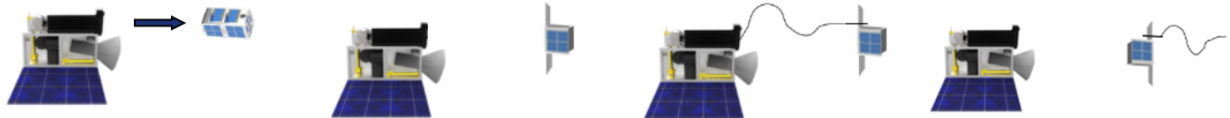

Fig. 2: **Harpoon Experiment**. This figure shows the sequence in the harpoon experiment: (a) cubesat ejection, (b) panel deployment, (c) harpoon capture, (d) deorbiting.



Fig. 3: **VBN Experiment**. This figure shows the sequence in the VBN experiment: (a) cubesat ejection, (b) VBN manoeuvres.

#### II.1.4. Other Experiments

The RemoveDEBRIS mission, in addition to performing the three primary experiments, also aims to test a few other developed technologies. These include the electric propulsion (EP) system and a  $10\text{ m}^2$  dragsail. These experiments are to be performed after the primary experiments and are explained in further depth in the payload section.

#### II.2. Orbit Selection

The current mission baseline for the orbit is  $600\text{ km}$  altitude, sun-synchronous (SSO) and at an LTAN (local time of ascending node) of 10.30 am.

#### II.3. Deorbit Times

The mission aims to comply with legal requirements for deorbiting including that objects placed in LEO (low Earth orbit) should naturally deorbit within 25 years, a key requirement of the UK Outer Space Act (OSA, 1986) and the French Space Operations Act (2008).

Various packages have been used to calculate the deorbit time for all objects placed in space including ESA's DRAMA (debris risk assessment and mitigation analysis) and CNES's STELA (semi-analytic tool for end of life analysis) [15]. In this research we present the results from STELA for each space object. Various interdisciplinary topics are involved in the evaluation of

Table 2: **RemoveDEBRIS Deorbit Times**. From STELA.

Object	Nominal Orbit Lifetime (yrs)
Platform (RemoveSAT)	27
DS-1 (Net)	7.6
DS-2 (Harpoon)	6.8
DS-3 (VBN)	6.8
Net (alone)	7.7
Harpoon (alone)	20.9

the orbital lifetime, including solar activity prediction and its effect on the atmospheric density, solar radiation pressure and drag modelling, third body effects as well as complex gravity models implementation. However, semi-analytical propagation techniques allow to evaluate the reentry duration in a reasonable computational time [16]. STELA has been validated by comparison to simulations based on fully numerical integration as well as real trajectories [17].

Table 2 summarises the preliminary results obtained. The results show that the compliance to the 25 years rule is achieved for all the objects, except for the main platform itself that is the one experiencing the least drag when the sail is not deployed. However, in such a contingency case, a small amount of propellant (1 to 2 kg) can be used to lower the altitude of the orbit enough to deorbit in less than twenty-five years.

### III. PLATFORM - REMOVE SAT

The RemoveDEBRIS platform, RemoveSAT, is a derivative of SSTL's next generation small satellite platforms, the SSTL X Series [18]. The RemoveDEBRIS mission provides an excellent opportunity to demonstrate the capabilities of this new platform. The X-series platform is built on 30 years of experience and success in SSTL of breaking low cost barriers and delivering operational level performance in small satellite packages.

#### III.1. Specifications

The top level specifications for the RemoveDEBRIS Platform are captured in Table 3.

Table 3: RemoveDEBRIS Platform Specification.

Parameter	Value
Mass	$\sim 120 \text{ kg}$
Envelope	$0.65 \text{ m} \times 0.65 \text{ m} \times 0.72 \text{ m}$
Downlink	$2 \text{ Mbps}$ (S-Band)
Uplink	$19.2 \text{ kbps}$
Payload Mass	$\sim 40 \text{ kg}$
Payload Power	$8 \text{ W}$ OAP (high peaks possible)
Pointing Knowledge	$\sim 2.5^\circ$
$\Delta V$	Up to $6 \text{ m/s}$

#### III.2. Platform Hardware

The RemoveDEBRIS platform architecture features a card frame based avionics suite at its core, with power, AOCS, data handing and TT&C elements all accommodated in card format within a single card frame assembly. Redundancy of primary systems (transceiver, Power BC, OBC) is achieved through simple duplication of the relevant cards. The card frame assembly is completed by means of a card frame which provides interfaces and connections between all of the core avionics elements, whilst also reducing platform harness mass and complexity.

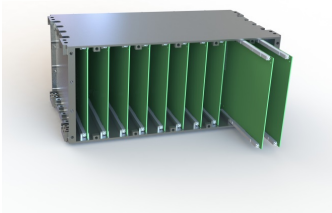

Fig. 5: Platform: Card Frame Assembly.

The remainder of the platform is made up of heritage SSTL subsystems and equipments. A full equipment list for the platform is included in Table 4.

#### III.3. Accommodation Study

The RemoveDEBRIS Platform Design accommodates the majority of the platform avionics and equipments in the lower half of the spacecraft, with the upper half of the spacecraft

Table 4: RemoveDEBRIS Platform Equipment List. \*space-based receiver, †magnetometer, ‡power distribution module, \*battery control module, ◇on-board computer, °electric propulsion payload

Equipment	Qty	Equipment	Qty
<b>ADCS</b>		<b>GPS</b>	
100-SP(O) Wheels	4	SGR-20*	1
Sun Sensors	4	GPS patch antenna	4
MTR-5 torquer rod	3	<b>Power</b>	
MTM Mk2†	2	PDM‡	2
STIM-210 Gyros	2	BCM*	3
AIM	2	Solar panels	3
<b>Comms. (S-band)</b>		Battery	1
Tx/Rx	2	<b>Propulsion</b>	
Tx Monopole antenna	4	Propellant tank	1
Rx Patch antenna	4	Propulsion controller	2
Tx Patch antenna	2	Resistojet	2
<b>Control</b>		Valves	2
OBC◇	2	$\mu\text{QCT}^\circ$ Valve	1
CAN bridge	1		

primarily dedicated to accommodating the RemoveDEBRIS Payloads. The spacecraft configuration can be seen in Figure 4.

The upper bay of the platform accommodates all of the RemoveDEBRIS payloads, in line with the mission profile and operations concept which essentially requires all payloads to be deployed in the same direction (and monitored in that direction).

#### III.4. Design Principles and Drivers

The X-Series platforms are being developed with some key drivers and principles in mind. These are a combination of (a) principles that SSTL have employed successfully in delivering small satellites in the last 25 years, and (b) new approaches that are enabled by SSTL's evolution as a company in the last 10 years, specifically the recently developed in house capabilities for batch/mass production and automated test. These key drivers and principles can be summarised as follows:

- The use of mature, well developed non space specific protocols such as CAN and LIN.
- On board autonomy, resulting in the elimination of the need for expensive, constantly manned ground segments.
- Robustness and redundancy; simple and robust operational modes that deliver competitive payload availability performance with multiple backup functionality and equipments on board to assure mission lifetime and guard against unforeseen and random outages and failures.
- The use of commercial-off-the-shelf (COTS) components and technologies building on over 25 years of successful implementation on operational missions.

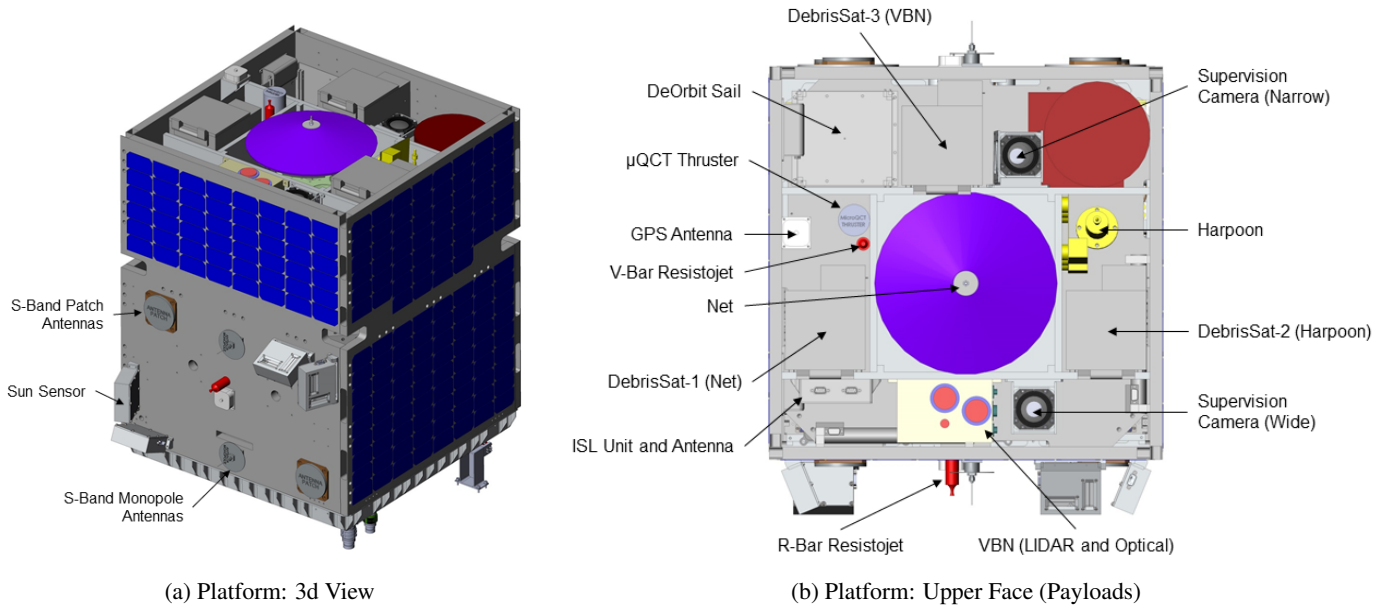

Fig. 4: Platform: Accommodation Study

- Modularity; investing the development of only a few key new systems that can be arranged in configurations to deliver a wide variety of performance and capacity variations depending on mission requirements.
- Low recurrent costs at unit level; maximising the use of automated manufacture and test capabilities to reduce expensive manpower costs, thereby achieving an extremely low unit level cost.

From an operations concept and fault detection, isolation and recovery (FDIR) point of view, the new design is functionally identical to the previous generation of SSTL spacecraft thus benefitting from the process of continuous refinement over three decades of SSTL small satellite mission design and operations.

### III.5. Ground Segment

Operations for the RemoveDEBRIS mission will be carried out from SSTL's Mission Operations Centre in Guildford as shown in Figure 6. SSTL's standard operations procedures will

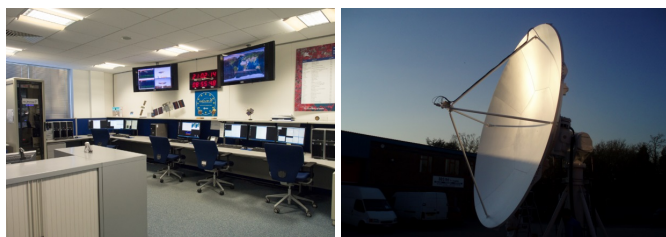

(a) Ground Station Room

(b) Dish Antenna

Fig. 6: Ground Station and Mission Operations Centre

be used, which are of course compatible with the SSTL designed platform operational requirements and characteristics.

## IV. CUBESATS - DEBRISATS

This section will outline the mission's cubesats, the DebrisATS produced by the Surrey Space Centre.

### IV.1. Net Cubesat - DS-1

DS-1 is based on a 2U Cubesat with the following dimensions:  $100 \times 100 \times 227 \text{ mm}$ , where 1U ( $100 \times 100 \times 100 \text{ mm}$ ) is reserved for the avionics and the remaining space is reserved for the inflatable structure. Figure 7 shows the cubesat structure. Figure 7 [a] shows the outer structure when the cubesat is undeployed. The avionics section features an interfacing port with the deployer, a camera that can be used to take imagery of the main platform as the cubesat is ejected, and the burn wire that holds the inflatable system in place. Figure 7 [b] shows the inside of the cubesat where the avionics boards are both clearly visible along with the central inflation connector system. The central connector is designed to house the inflation system, a cold gas generator (CGG), and a solenoid valve. The role of this valve is to allow trapped air escape during the launch phase. Prior to the deployment of the structure this valve must be closed, to form a leak free system. The central housing may be constructed from sections of aluminium, which are sealed using a set of o-rings.

Figure 7 [c] shows the first deployment stage, where the burn wire is burnt and the inflation system is released downwards by means of two high torsion springs. Once the CGG is activated, the booms simultaneously inflate forming the overall balloon structure. This is shown in Figure 7 [d] where the wires and balloon sheeting is not shown.

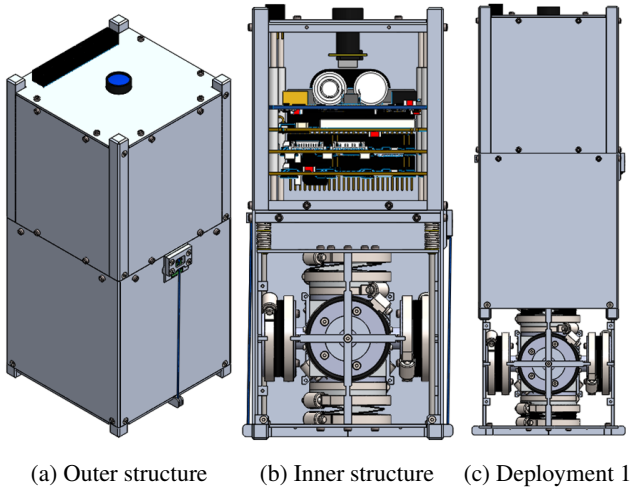

(a) Outer structure (b) Inner structure (c) Deployment 1

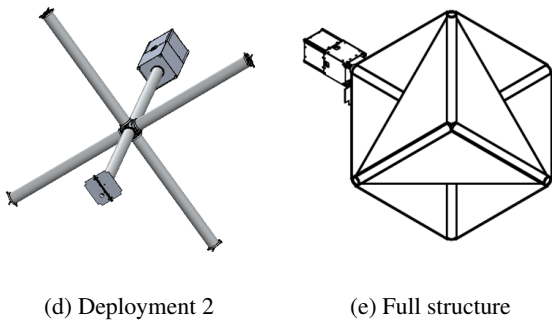

(d) Deployment 2 (e) Full structure

Fig. 7: Net Cubesat (DS-1): Structure

Figure 7 [e] shows the fully inflated balloon including wires and membrane which resembles an octahedron tensegrity. To establish the shape of the inflatable structure, several geometries were investigated. The well proven spherical envelope was selected as a benchmark against which other geometries were evaluated. The final design has a minimal gas volume allowing smaller CGGs to be used and the sheeting membranes are attached axially, rather than being bounded by the inflatable members. This design choice reduced the sail material surface area by 25%, but the projected area remained the same.

As DS-1 has no control system, the balloon is free to tumble.

#### IV.2. Harpoon Cubesat

The harpoon cubesat, DS-2, can be seen in Figure 8. The cubesat is again a 2U, like DS-1 where 1U is used for avionics and 1U is used as a harpoon capture box. As can be seen in Figure 8 [a], the cubesat deploys four panels in the shape of a cross, increasing the likelihood the harpoon will hit. The cubesat has a momentum wheel that is activated just before leaving the platform, enabling any unwanted tumbling motion to be converted into a gyroscopic motion. The cubesat features a series of debris-capture materials on each panel (a bag or net) that is designed to capture any debris produced by the harpoon. The harpoon is designed in such a way to contain debris from the impact face and also has an end-stop to prevent it from passing through the impact surface; the bags collect any potential debris from the rear of the impact panel.

Figure 8 [b] shows the internal avionics in the cubesat (discussed later). An internally mounted camera observes the impact panels and is able to photograph the impact. A series of LEDs light up the impact space providing light for the camera.

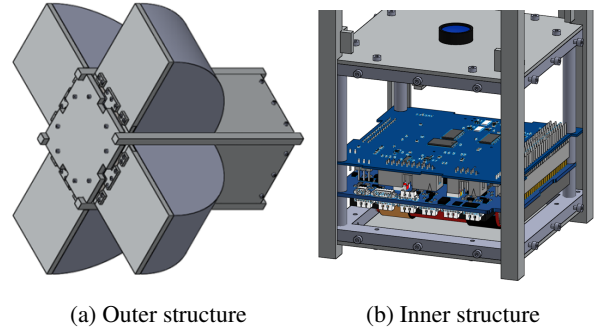

(a) Outer structure (b) Inner structure

Fig. 8: Harpoon (DS-2) & VBN (DS-3) Cubesats: Structure

#### IV.3. VBN Cubesat

In the VBN scenario, the VBN payload on the platform will inspect the VBN cubesat, DS-3, during a series of manoeuvres at a range of distances and in different light conditions dependent on the orbit. DS-3 will take the same structure as DS-2. The panels will deploy in the same cross shape, removing cubesat symmetry and enabling the VBN payload to better identify the cubesat attitude. DS-3 has similar avionics to DS-2, except it contains a full AOCS system allowing full 3 degree of freedom (3-DoF) control.

#### IV.4. Avionics

The cubesat avionics are primarily based on the QB50 avionics developed by the Surrey Space Centre and the Electronic Systems Laboratory (ESL) at Stellenbosch University [19]. The QB50 stack, shown in Figure 9 consists of 3 boards, the CubeComputer, CubeControl and CubeSense boards which in conjunction provide 3-DoF attitude control to a cubesat.

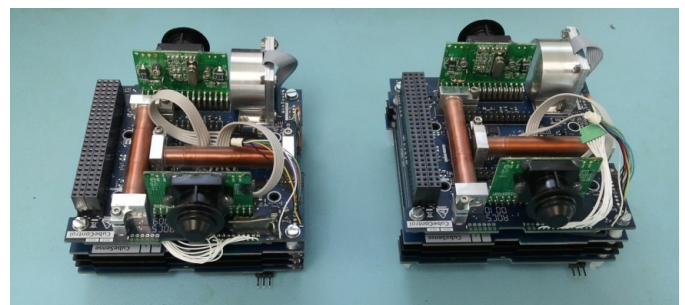

Fig. 9: Avionics: QB50 Full Stack. Showing 2 distinct units.

The primary boards are shown in Figure 10. The CubeComputer performs the cubesat processing and contains a 32-bit ARM Cortex-M3 including flash for in-flight reprogramming (dual redundant), an FPGA for flow-through error correction in case of a radiation upset on the memory and a MicroSD card for data

storage. The CubeControl controls both magnetometers and samples connected sensors. The CubeSense contains both sun and nadir sensors.

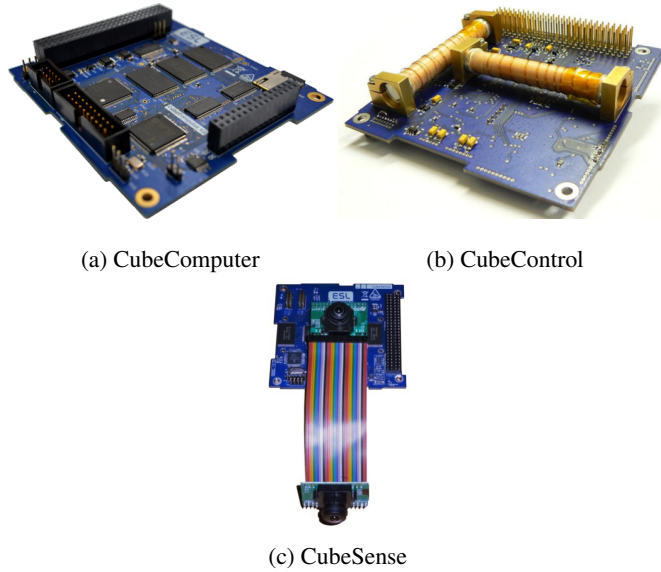

Fig. 10: Avionics: Individual Boards

Not all of the boards are used on each cubesat; the boards used in each cubesat are given in Table 5. Note each cubesat also requires a power board (DS-1 and DS-2 have only a single battery, whilst DS-3 has solar panels as well). Each cubesat also has an inter-satellite link (ISL) that is used to communicate with the platform. In the case of DS-1 this is used for the platform to command balloon inflation and to receive imagery back from the camera. For DS-2 and DS-3, as well as imagery data, the ISL is also used to transmit telemetry and sensor data to the platform and for the platform to command desired cubesat attitudes. The cubesats do not have a communication link directly with Earth that consumes a lot of power, instead all cubesat to ground communication is via the platform. DS-1 also has an additional board for control of the air valve and the CGG system.

Table 5: **Cubesat Avionics Boards.** \*on-board computer, †electrical power system, ‡inter-satellite link, \*momentum wheel

Cubesat	Board
DS-1 (Net)	CubeComputer (OBC*) board
	EPS <sup>†</sup> board
	ISL <sup>‡</sup> board
	CGG & valve control board
DS-2 (Harpoon)	CubeComputer (OBC) + MW* board
	EPS board
	ISL board
DS-3 (VBN)	CubeComputer (OBC) + GPS board
	CubeControl (AOCS) + 3 wheels board
	CubeSense (AOCS) board
	EPS board
	ISL board

#### IV.5. Deployer

The 3 target cubesats for the RemoveDEBRIS project are carried onboard the host satellite inside 3 dedicated cubesat dispensers provided by ISIS Innovative Solutions In Space. For this particular mission ISIS is redesigning its heritage ISIPOD cubesat dispenser system to meet the specific mission objectives for the project. Normally the cubesat dispensers deploy the cubesats into orbit from an upper stage of a rocket and are activated within the first hour of the launch. For RemoveDEBRIS, the cubesats will be deployed from a host satellite, which causes specific integration and accommodation challenges and in addition the cubesats will be deployed long after launch. This has some key implications for the dispenser system. The dispenser now needs to withstand up to several months in orbit before the host satellite will activate the dispensers to eject the target cubesats.

Moreover, the target cubesat inside the dispensers will also need to be stowed inside the host satellites a long time. The dispensers will be outfitted with a special interface so the host satellite can charge the batteries of the target cubesats and can perform in-space checkout routines by offering an interface to the target cubesat computer. Finally, a major modification specific for the RemoveDEBRIS dispenser compared to the normal dispensers is the deployment velocity for the Target cubesats. Nominally the cubesats are ejected with a deployment velocity of 1 to 2  $m/s$  in order to ensure that the cubesats separates sufficiently fast from the launch vehicle upper stage. However, given the mission of RemoveDEBRIS, there are requirements to keep the target satellites close to the host spacecraft so there is a minimum risk of losing sight of the Targets. Therefore, the cubesat dispensers are modified and complemented with an additional low speed deployment functionality that will allow a very low deployment velocity as low as 5  $cm/s$  for the deployment of the target cubesats. Ideally, these speeds are 2  $cm/s$  for the harpoon demonstration and 5  $cm/s$  for the net demonstration.

## V. PAYLOADS

### V.1. Net

The Net Capture Mechanism (NETCAM) will be accommodated on top of the spacecraft bus and is provided by Airbus DS Bremen. After activation command from On-Board-Computer a net will be deployed to capture a nano-sat released from the spacecraft approximately 100  $s$  before. After entanglement of the net around the target, the net will be closed by motor driven winches, integrated to the net deployment masses.

#### V.1.1. Net Hardware

The NETCAM design is shown in Figure 11. The NETCAM has 275  $mm$  diameter and a height of 220  $mm$ . The total weight target is 6.5  $kg$ . Usually, the net will be connected with the spacecraft via a tether to pull the target and eventually initiate the controlled deorbitation. However, for RemoveDEBRIS the tether will not be fixed on the spacecraft side to avoid two body dynamic impacts due to the low thrust propulsion system of the platform.



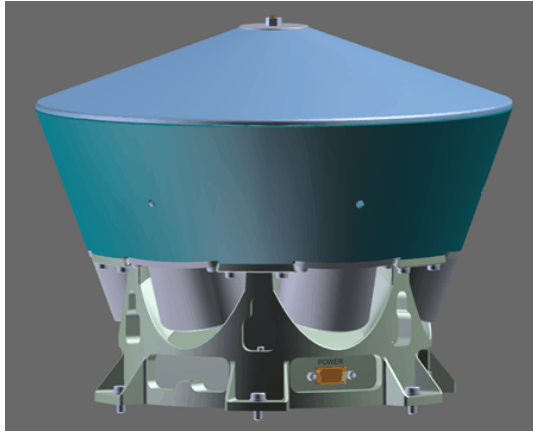

Fig. 11: NETCAM Payload.

A hemispherical spider type net shall be used for the RemoveDEBRIS project (see Figure 12). The net shall have 5 m diameter. Kevlar has been chosen as material. The total weight of the net shall be approximately 0.6 kg. A mesh size of 80 mm was selected, because this may prevent the target from escaping even if the inflation/enlargement fails. It has been realized that not all 196 meridian lines can really run from the circumference to the pol (i.e. the lid of the NETCAM), because this would yield a huge bundle of lines at the pol. For the NETCAM only 6 lines will directly connect the deployment masses with the lid. All other meridian lines will end at intermediate latitude lines.

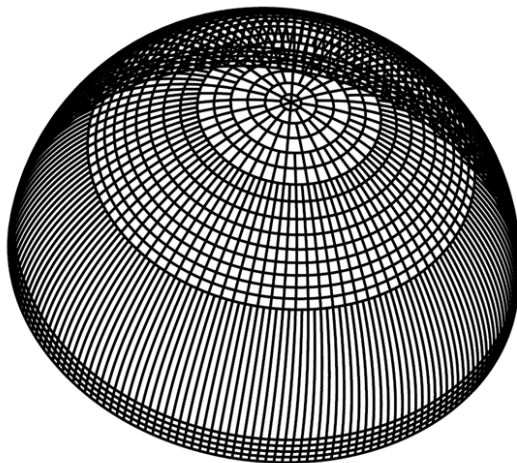

Fig. 12: Hemispherical Net.

## V.2. Harpoon

The Harpoon Capture System (HCS) is being developed by Airbus DS Stevenage as a mission enabling capture system for future ADR missions. The RemoveDEBRIS mission serves to raise the TRL of key elements of the HCS, providing a platform to test the technology in the space environment. The HCS is designed to establish a hard point attachment to debris and provide a link to the chaser via a flexible coupling. A flexible link allows for deployment from a stand-off distance, reducing

the risk to the chaser during stabilisation or towing. The HCS has several features which led to its selection:

- Low mass and volume allowing the possibility to host multiple harpoons on a single spacecraft
- Relative simplicity leading to high reliability, low development risk and low cost
- High firing speed ensuring compatibility with objects spinning at fast rates
- Ability to perform comprehensive characterisation of capture on ground

### V.2.1. Harpoon Hardware

The baseline harpoon concept for large debris items was developed under internal Airbus R&D [20] and a small scale demonstrator has been accepted for flight test on RemoveDEBRIS. The HCS designed for RemoveDEBRIS is composed of 3 main elements; Deployer, Projectile and Tether, see Figure 13.

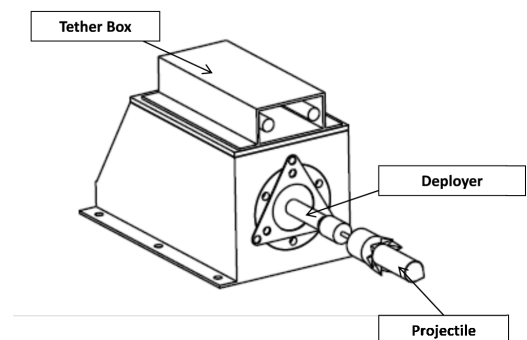

Fig. 13: Overview of the HCS Payload.

The Deployer imparts sufficient velocity to the projectile for penetration of the target structure. Extensive ground characterisation has established that 20m/s is required to penetrate the targets aluminium honeycomb panels. Energy is provided to the system by a gas generator mounted at the back of the Deployer. Upon activating gas is released into the chamber volume, increasing the force applied against a piston. The piston is held by a tear pin until a set failure stress is reached, resulting in the piston propelling the projectile out of the Deployer. To provide fault tolerance against premature deployment, a hold down and release (HDR) mechanism is to be incorporated on the flight model.

The projectile is shown in Figure 14. The projectile is designed to penetrate the target panel and successfully deploy a set of barbs on the opposite side, providing the crucial locking interface with the target. A shroud protects the barbs during the penetration of the structure and allows the harpoon to capture targets with misalignments of up to 45°. Free release of the tether is a key influence on the accuracy of the HCS. Tests have been performed to select the ideal spool arrangement and mounting location to minimise inaccuracy in impact location.

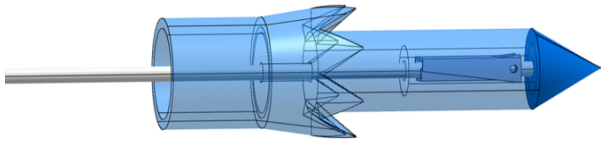

Fig. 14: RemoveDEBRIS Harpoon Projectile.

### V.2.2. Harpoon Testing

A significant benefit of the harpoon is that validation of many aspects can be performed on ground in the Airbus DS test range shown in Figure Figure 15. The availability of a test range allows for many of the design challenges to be overcome and characterised on ground before use on-orbit. The test rig has allowed many design variables to be tested; projectile configuration, panel type, panel offset, chaser momentum. The availability of the test rig allows the rapid prototype development and identification of key design variables that are difficult to identify using classical design approaches.

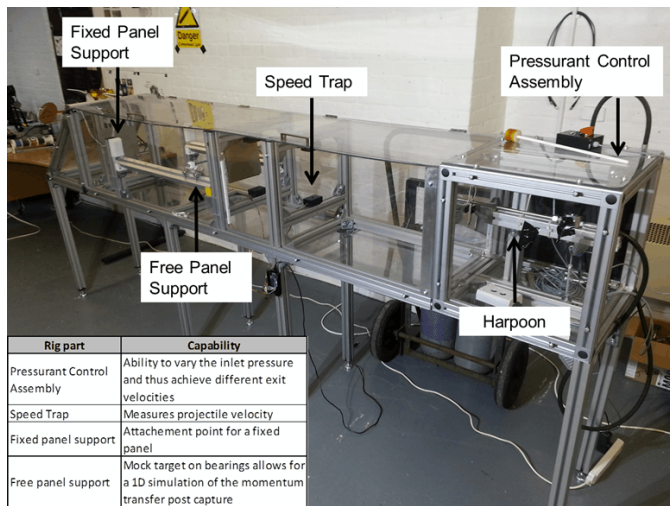

Fig. 15: Harpoon Test Rig.

The opportunity for the RemoveDEBRIS in-flight demonstration of the HCS is the next step the development of the technology for adoption on a future ADR mission. The mission will demonstrate the HCS functionality in the LEO environment. RemoveDEBRIS will advance the HCS beyond Airbus DS concept and breadboards and inform the development of an integrated system design that can be considered for future ADR missions.

### V.3. VBN

Airbus DS Toulouse has been strongly involved in the design of vision-based navigation (VBN) systems over the last years, with particular focus on applications such as planetary landing and orbital rendezvous, typically in the context of Mars Sample Return missions. Based on this background and due to the increasing interest in ADR, solutions for autonomous, vision-based navigation for non-cooperative rendezvous have

been investigated. Dedicated image processing (IP) and navigation algorithms have been designed at Airbus DS and INRIA to meet this specific case, and some of them have already been tested over synthetic images and actual pictures of various spacecraft [21]. As the next step, the VBN demonstration onboard RemoveDEBRIS will validate VBN equipment and algorithms, through ground-based processing of actual images acquired in flight, in conditions fully representative of ADR. The VBN demonstration will thus fulfil the following objectives:

- Demonstrate state-of-the-art image processing and navigation algorithms based on actual flight data, acquired through two different but complementary sensors: a standard camera, and a flash imaging LiDAR.
- Validate a flash imaging LiDAR in flight, raising its TRL to level 7.
- Provide an on-board processing function in order to support navigation.

#### V.3.1. VBN Hardware

Images will be captured from two main optical sensors: a conventional 2D camera (passive imager) and an innovative flash imaging LiDAR (active imager), developed by the Swiss Centre for Electronics and Microsystems (CSEM). It will be a scaled-down version of a 3D imaging device currently developed and tested in the frame of 'Fosternav' FP7 project for the European Commission focusing on landing and rendezvous applications. This architecture has the particularity of providing ranging capability by measuring the phase difference of two signals. It will be the first time in Europe that a device based on flash imaging LiDAR technology - considered to be a key enabling technology by the space community for the future success of exploration missions with landing, rendezvous and rover navigation phases - will be used for debris tracking and capture control. Such experiment will allow Europe to master state of the art technologies in the field of 3D vision sensors for GNC systems. The hardware is shown in Figure 16.

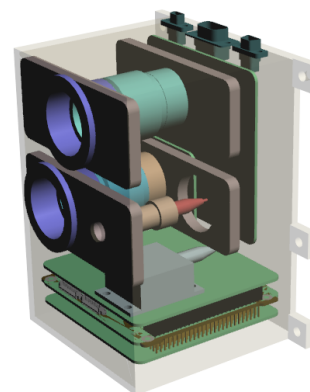

Fig. 16: VBN Hardware.

### V.3.2. Demonstration Trajectory

In a first step, 3D and 2D images will be captured from the start of the operational phase, i.e. when DS-1 is released for preliminary checks, monitoring purposes, as well as a first collection of data covering the net experiment. In a second step, the VBN demonstration per se will start, and will consist in capturing images of DS-3 from various distances and over large duration in order to make sure that the widest range of visual configurations (in terms of distance to target, relative attitude, light conditions, background) is reached. This will make the experiment as much demonstrative as possible, while meeting the classical duration and cost constraints of a low-cost demonstration mission. Starting from DS-3 ejection, several types of rendezvous maneuvers are possible, and a reference scenario made up of hops trajectories based on radial (R-bar) or velocity (V-bar) burns is being defined. These maneuvers are all standard and representative of future debris removal proximity operations, such as final rendezvous, inspection and capture. A possible trajectory combining these different maneuvers so as to maximize the range of visual configurations between RemoveSAT and DS-3 while minimizing propellant consumption is illustrated in Figure 17 hereafter.

After DS-3 deploys a dragsail that will hasten its orbital decay, the 3D and 2D cameras will continue to collect imagery as long as Line-Of-Sight (LOS) is maintained. Image data will be downloaded during ground contact windows.

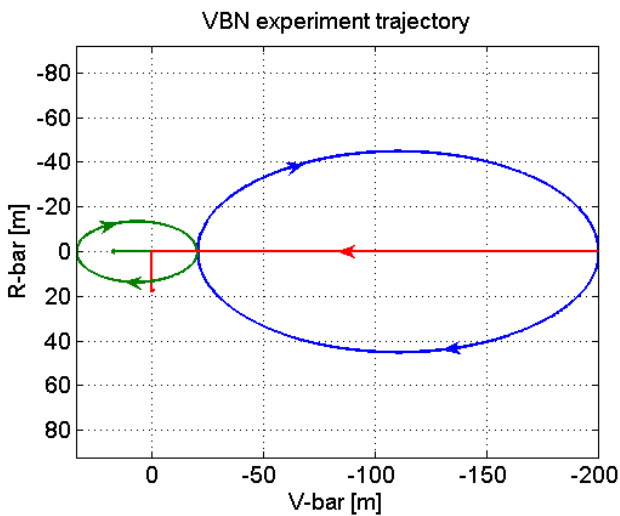

Fig. 17: VBN Demonstration Trajectory.

### V.3.3. On-ground Processing

All the data acquired during the VBN experiment will be processed on the ground with innovative IP algorithms (e.g. 2D/3D and 3D/3D matching techniques) and specifically tuned navigation algorithms based on an Extended Kalman Filter able to fuse data from different sensors (e.g. camera images and attitude sensing data).

Differential GPS and onboard attitude estimation software will also provide ‘ground truth’ data against which the navigation algorithms will be compared for validation and performance

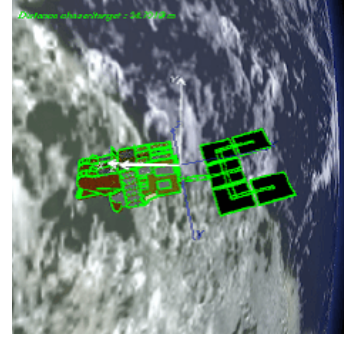

Fig. 18: 2D / 3D Matching.

assessment. Post-processing activities will allow demonstration of performances of innovative 2D camera based navigation and 3D camera based navigation, allowing not only estimation of relative position and velocity but also relative attitude, one of the key drivers of successful capture of an uncooperative target.

### V.4. Cameras

The RemoveSAT platform will house two supervision cameras: one dedicated to the net demonstration with a  $65 \times 54$  degree field of view (FoV) and one dedicated to the harpoon demonstration with a  $17 \times 14$  degree FoV.

The supervision cameras are based on SSTL’s heritage system, shown in Figure 19, flown on the Technology Demonstration Satellite-1 (TDS-1) launched in July, 2014. This camera system uses COTS technology combining a colour CMOS camera with a high performance machine vision lens capable of delivering video. Both camera and lens are stripped down and all unsuitable components removed before being ruggedised during reassembly to survive the vibration and shock loads experienced during launch as well as making it suitable for the space environment. The camera system will be optimised to give a depth of field capable of meeting the performance requirements for the two demonstrations. Customised mounting brackets will be used to point the camera in the required direction for the demonstrations. The cameras will use a CameraLink interface to the PIU. They

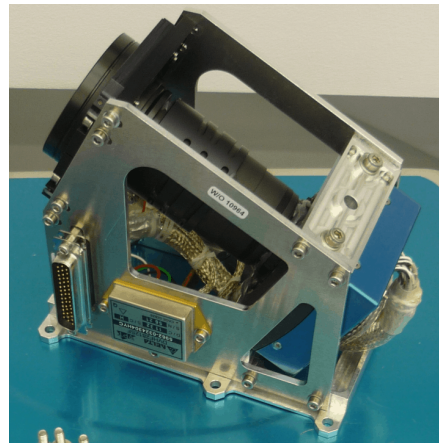

Fig. 19: Supervision Camera. With housing.

will acquire 8 bit images that are  $1280 \times 1024$  pixels in size at 10 frames per second. Figure 20 shows an image taken of the antenna pointing mechanism (APM) on TDS-1 just after launch with Earth in the background.



Fig. 20: **Supervision Camera.** Image from camera on TDS-1 of APM with Earth in the background.

#### V.5. EP

Electric propulsion is currently one payload baselined for the mission. The  $\mu$ QCT (micro-quad confinement thruster) is a Surrey Space Centre experimental thruster that operates at between 1 W and 40 W. It has no hollow cathode neutralizer and the ion beam is neutralized by means of an inertial electrostatic confinement stage. Electrical characterization of the neutralizer stage and anode have been obtained as a function of propellant mass flow rate. The thruster requires a high-voltage step-up power system to provide a 1000 V supply voltage.

#### V.6. Dragsail

The RemoveDEBRIS platform will have a Surrey Space Centre dragsail payload. The dragsail concept can be seen in Figure 23. The dragsail consists of 2 parts: a deployer which extends the sail away from the platform (preventing the sail from hitting any overhanging platform hardware e.g. antennas), and an extension mechanism which uses a motor to unfurl carbon fibre booms that hold the sail membrane. Figure 24 shows both of these mechanisms. The deployer is a mechanical two stage ejector that uses a series of springs to eject the system. The extension mechanism consists of four booms rolled into a central distributor that allows controlled unfurling of the sail.

### VI. ADR REGULATORY ISSUES

The RemoveDEBRIS mission intends to fully comply with all relevant national and international space laws. In particular, it is of prime importance that all space elements released into orbit deorbit within 25 years as demonstrated in the deorbit analysis section. The net and harpoon are also being designed to be trackable from space for the very worst case they miss their targets. Both of these guarantee even if these items miss they

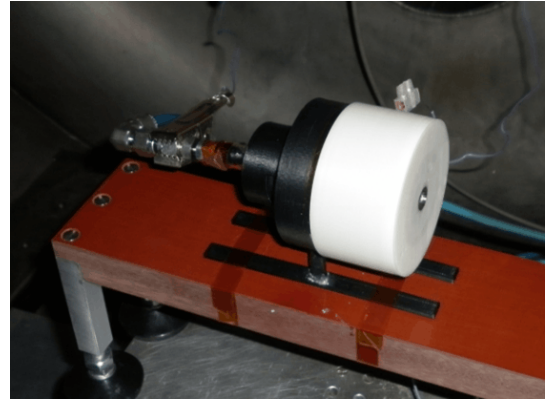

Fig. 21:  $\mu$ QCT Payload.

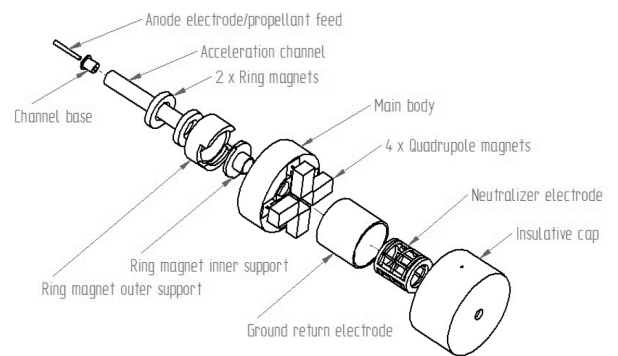

Fig. 22:  $\mu$ QCT Payload: Parts.

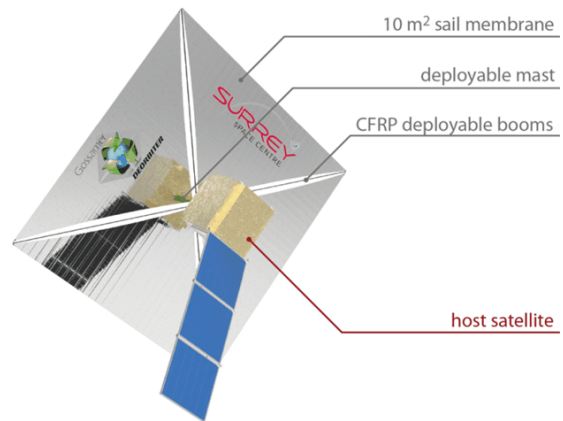
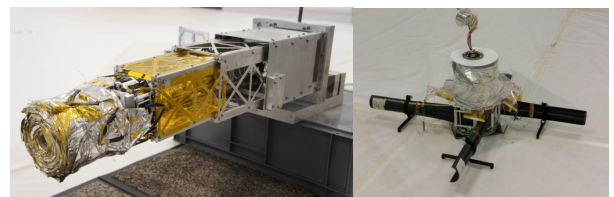

Fig. 23: **Dragsail Concept.**



(a) Deployment Mechanism (b) Extension Mechanism

Fig. 24: **Dragsail Payload**

will deorbit within 25 years and can be fully tracked during this period. It is also important to not contribute to the production of further debris in space. For example special provisions have been placed on the addition of debris containment bags around DS-2, which help ensure that when the harpoon hits the cubesat target any debris which might be produced does not escape, even if extensive ground tests show that debris is not created from the kinetic impact of the harpoon. Finally, cubesats are used here as artificial debris targets; this avoids any legal issues with targeting, capturing or deorbiting debris that is legally owned by other entities.

The RemoveDEBRIS consortium aims to work with the EU, UK space agency (UKSA), ESA, CNES and other agencies/entities to provide the latest project achievements, incorporate their feedback, communicate and interface with them on all necessary regulatory procedures required for the RemoveDEBRIS mission.

## VII. CONCLUSIONS

RemoveDEBRIS is aimed at performing key ADR technology demonstrations (e.g capture, deorbiting) representative of an operational scenario during a low-cost mission using novel key technologies for future missions in what promises to be the first ADR technology mission internationally. This paper has provided an overview of the consortium, mission, platform and payloads. Key ADR technologies include the use of harpoon and net to capture debris, vision-based navigation to target debris and a dragsail for deorbiting. Although this is not a fully-edged ADR mission as cubesats are utilised as artificial debris targets, the project is an important step towards a fully operational ADR mission; the mission proposed is a vital prerequisite in achieving the ultimate goal of a cleaner Earth orbital environment.

## VIII. ACKNOWLEDGEMENTS

This research is supported by the European Commission FP7-SPACE-2013-1 (project 607099) 'RemoveDEBRIS - A Low Cost Active Debris Removal Demonstration Mission', a consortium partnership project consisting of: Surrey Space Centre (University of Surrey), SSTL, Airbus DS (formerly Astrium) GmbH, Airbus SAS, Airbus Ltd, ISIS, CSEM, Inria, Stellenbosch University.

Additional thanks to the following contributors to this paper: Gabriel Secheli, Adam Hoskin, Aaron Knoll.

## REFERENCES

- [1] J. L. Forshaw, V. J. Lappas, A. Pisseloup, T. Salmon, T. Chabot, I. Retat, S. Barraclough, A. Bradford, J. Rotteveel, F. Chaumette, A. Pollini, W. H. Steyn, RemoveDEBRIS: A low cost R&D ADR demonstration mission, in: CNES 3rd European Workshop on Space Debris Modeling and Remediation, Paris, France, 2014.
- [2] C. Saunders, A. Chiesa, J. L. Forshaw, B. Parreira, R. Biesbroek, Results of a system feasibility study on a heavy active debris removal mission, in: CNES 3rd European Workshop on Space Debris Modeling and Remediation, Paris, France, 2014.
- [3] C. Saunders, J. L. Forshaw, V. J. Lappas, A. Chiesa, B. Parreira, R. Biesbroek, Mission and systems design for the debris removal of massive satellites, in: 65th International Astronautical Congress, Toronto, Canada, 2014.
- [4] C. Saunders, J. L. Forshaw, V. J. Lappas, D. Wade, D. Iron, R. Biesbroek, Business and economic considerations for service oriented active debris removal missions, in: 65th International Astronautical Congress, Toronto, Canada, 2014.
- [5] European Space Agency, e.Deorbit CDF Study Report, Tech. Rep. CDF-134(A), European Space Agency (2012).
- [6] C. Cougnet, B. Gerber, C. Heemskerk, K. Kapellos, G. Visentin, On-orbit servicing system of a geo satellite fleet, in: 9th ESA Workshop on Advanced Space Technologies for Robotics and Automation 'ASTRA 2006', ESTEC, Netherlands, 2006.
- [7] C. Bonnal, Active debris removal: Current status of activities in CNES, in: P<sup>2</sup>ROTECT workshop, Ankara, Turkey, 2012.
- [8] D. Reintsema, B. Sommer, T. Wolf, J. Theater, A. Radthke, W. Naumann, P. Rank, J. Sommer, DEOS - the in-flight technology demonstration of german's robotics approach to dispose malfunctioned satellites, in: ESA 11th Symposium on Advanced Space Technologies in Robotics and Automation, ESTEC, Netherlands, 2011.
- [9] M. Richard, L. Kronig, F. Belloni, S. Rossi, V. Gass, C. Paccolat, J. Thiran, S. Araomi, I. Gavrilovich, H. Shea, Uncooperative rendezvous and docking for microsats: The case for cleanspace one, in: 6th International Conference on Recent Advances in Space Technologies (RAST), Istanbul, Turkey, 2013.
- [10] B. Chamot, Mission and system architecture design for active removal of rocket bodies in low earth orbit, Master's thesis, Massachusetts Institute of Technology, US (August 2012).
- [11] M. Merino, E. Ahedo, C. Bombardelli, H. Urrutxua, J. Pelaez, L. Sumner, Space debris removal with an ion beam shepherd satellite: target-plasma interaction, in: 47th AIAA/ASME/SAE/ASEE Joint Propulsion Conference & Exhibit, San Diego, US, 2011.
- [12] L. Z. Jasper, C. R. Seubert, H. Schaub, T. Valery, E. Yutkin, Tethered tug for large low earth orbit debris removal, in: American Institute of Aeronautics and Astronautics Astrodynamics Specialists Conference, no. AAS 12-252, San Diego, US, 2012.
- [13] L. Z. Jasper, H. Schaub, Input shaped large thrust maneuver with a tethered debris object, in: 6th European Conference on Space Debris, no. 6a.O-11, ESOC, Darmstadt, Germany, 2013.
- [14] Astrium Space Transportation, ROGER Phase-A Final Report Executive Summary, Tech. Rep. ROG-SIBRE-EXS, Astrium Space Transportation (2003).
- [15] Le Fevre et al., Compliance of disposal orbits with the French Space Act: the good practices and the STELA tool, *Acta Astronautica* 94 (1).
- [16] Fraysse et al., Long term orbit propagation techniques developed in the frame of the French Space Act, *Journal of Aerospace Engineering, Sciences and Applications* 4 (4).
- [17] C. Bonnal, CNES activities related to space debris, in: P<sup>2</sup>ROTECT workshop, Torino, Italy, 2013.
- [18] A. Bradford, L. Gomes, S. Kenyon, D. Stanton, J. Penson, Lowering the cost of space access - a new generation of low cost SSTL platforms, in: 64th International Astronautical Congress, Beijing, China, 2013.
- [19] L. Visagie, J. L. Forshaw, T. E. Frame, V. J. Lappas, W. H. Steyn, A miniaturised attitude control and determination system for the QB50 and SME-SAT missions, in: ESA Guidance, Navigation, and Control Conference, Porto, Portugal, 2014.
- [20] J. Reed, S. Barraclough, Development of harpoon system for capturing space debris, in: 6th European Conference on Space Debris, Darmstadt, Germany, 2013.
- [21] A. Petit, E. Marchand, K. Kanani., Tracking complex targets for space rendezvous and debris removal applications, in: IEEE/RSJ Conference on Intelligent Robots and Systems, IROS' 12, Vilamoura, Portugal, 2012.