



**HAL**  
open science

## Bidimensional traffic flow models.

Jean-Patrick Lebacque

► **To cite this version:**

Jean-Patrick Lebacque. Bidimensional traffic flow models.. NETCO 2014, 2014, Tours, France. hal-01024670

**HAL Id: hal-01024670**

**<https://inria.hal.science/hal-01024670>**

Submitted on 16 Jul 2014

**HAL** is a multi-disciplinary open access archive for the deposit and dissemination of scientific research documents, whether they are published or not. The documents may come from teaching and research institutions in France or abroad, or from public or private research centers.

L'archive ouverte pluridisciplinaire **HAL**, est destinée au dépôt et à la diffusion de documents scientifiques de niveau recherche, publiés ou non, émanant des établissements d'enseignement et de recherche français ou étrangers, des laboratoires publics ou privés.

# Bidimensional traffic flow models.



**J.P. Lebacque**

*IFSTTAR-COSYS-GRETTIA*

*Le Descartes 2, 2 rue de la Butte Verte*

*F93166 Noisy-le-Grand, France*

*[Jean-patrick.lebacque@ifsttar.fr](mailto:Jean-patrick.lebacque@ifsttar.fr)*

**Netco 2014**  
**Tours, June 23-27, 2014**



# Outline of the presentation

---

1. Motivation
2. Static assignment
3. Pedestrian models
4. Macroscopic fundamental diagrams
5. Anisotropic models

# Some references

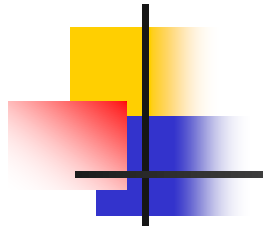

- M. Beckmann. A continuous model of transportation. *Econometrica*, Vol. 20 :643–660, 1952.
- Nikolas Geroliminis and Carlos Daganzo. Existence of urban-scale macroscopic fundamental diagrams : some experimental findings. *Transportation Research B*, Vol. 42, N°9 :759–770, November 2008.
- Serge P. Hoogendoorn and Piet H.L. Boyv. Dynamic user-optimal assignment in continuous time and space. *Transportation Research B*, Vol. 38, N°7 :571–592, August 2004.
- H.W. Ho, S.C. Wong, and Becky P.Y. Loo. Combined distribution and assignment model for a continuum equilibrium traffic with multiple user classes. *Transportation Research B : Methodological*, Vol.40, N°8 :633–650, September 2006.
- Roger L. Hughes. A continuum theory for the flow of pedestrians. *Transportation Research Part B : Methodological*, Vol. 36, N°6 :507–535, July 2002.
- Jean-Patrick Lebacque and Megan Khoshyaran. First-order macroscopic traffic flow models : intersection modeling, network modeling. *Transportation and Traffic Theory. Flow, Dynamics and Human Interaction*, 16th International Symposium on Transportation and Traffic Theory :365–386, August 2005.
- Azuma Taguchi and Masao Iri. Continuum approximation to dense networks and its application to the analysis of urban road networks. *Mathematical programming study*, Vol. 20 :178–217, 1982.
- S.C. Wong. Multi-commodity traffic assignment by continuum approximation of network flow with variable demand. *Transportation Research B*, Vol. 32, N°8 :567–581, November 1998.
- Tibye Saumtally, Jean-Patrick Lebacque and Habib Haj-Salem. A dynamical two-dimensional traffic model in an anisotropic network . NETWORKS AND HETEROGENEOUS MEDIA American Institute of Mathematical Sciences Volume 8, Number 3, September 2013 pp. 663-684



# Introduction

---

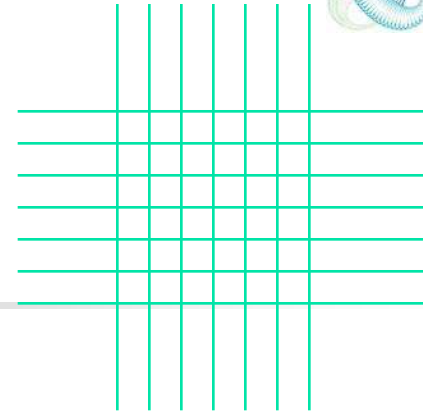

- What is bidimensional modelling of traffic flow?
  - Approximation of the network by a bidimensional medium
  - Approximation of traffic on links by a bidimensional fluid flow

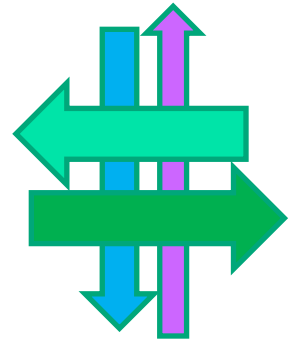

# Why bidimensional modelling?

- Complexity of large networks
  - Ex Madrid

21713 arcs, 10636 nœuds, 1179 centroïdes

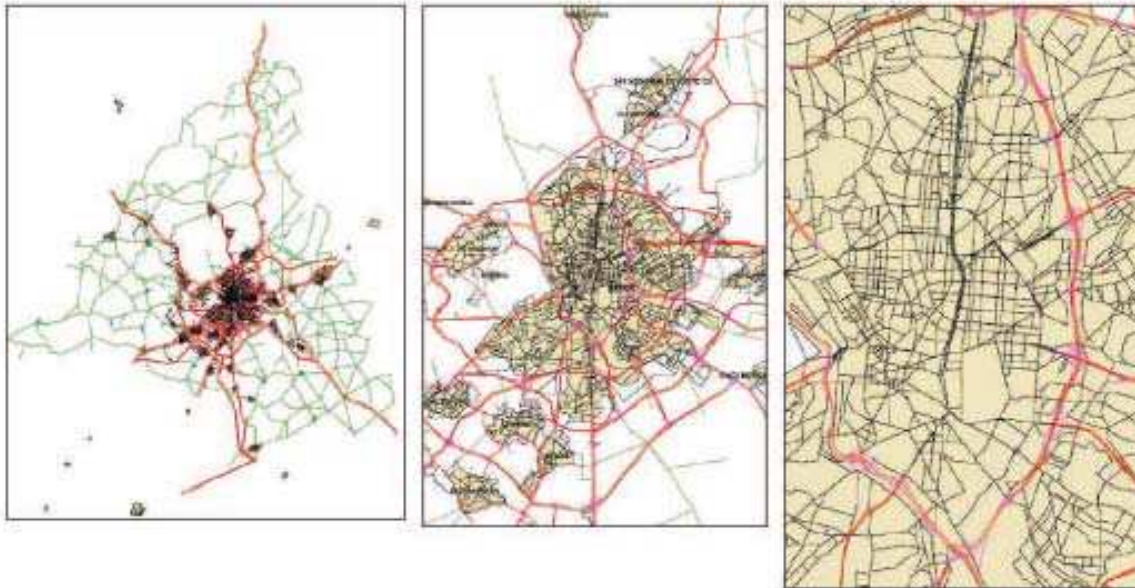

# Paris and close surroundings

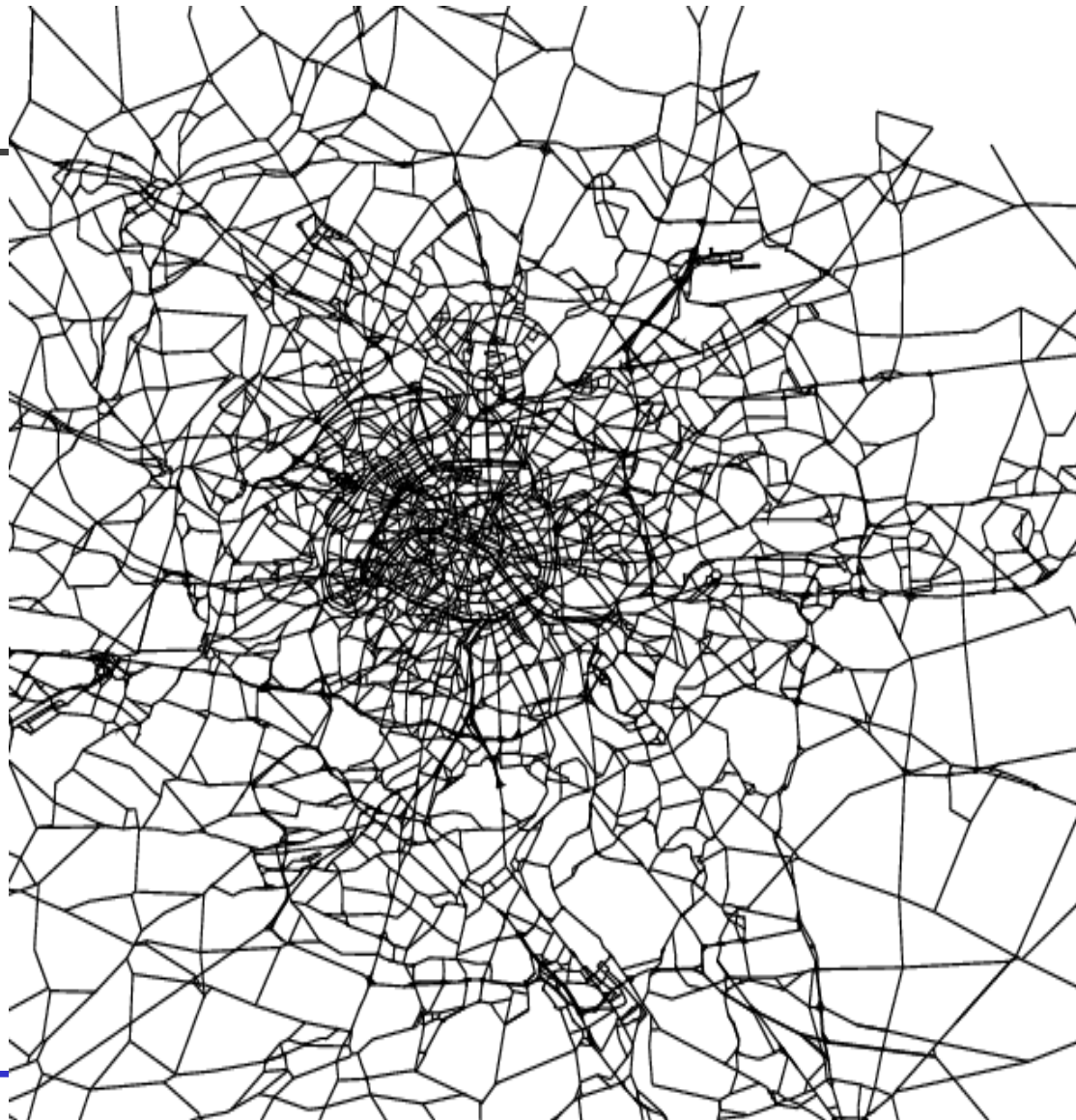

*Netco 2014, Tours, June 23-27, 2014*



# Ile de France network (36800 links)

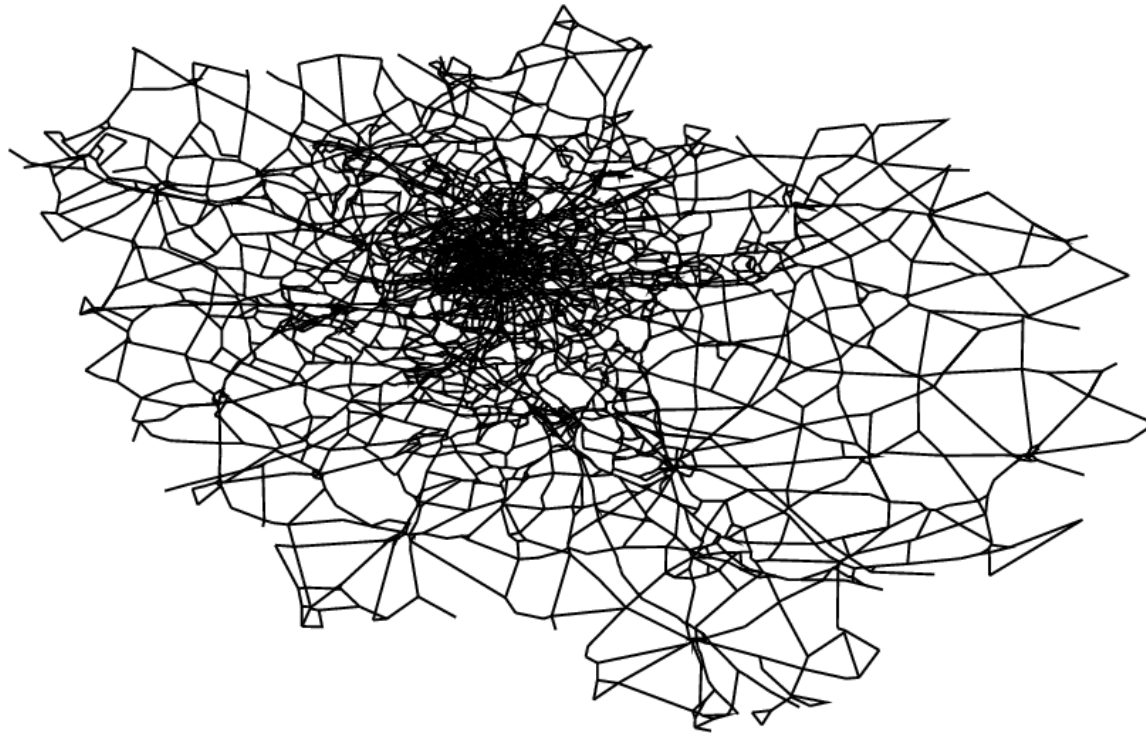
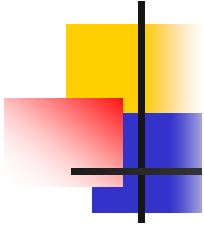





# Traffic measurements

---

- Classical (eulerian): detectors (loops, cameras) → flows, Occupancies, Speeds
    - Fixed measurement points
    - Problem: too few measurement points (many links don't have any)
  - Lagrangian (related to vehicles: GPS, smart phones) → trajectories, velocities, travel times
    - Mobile measurement points
    - Problem: measurement points not well distributed, biases in measurement
-

# Exemple: traffic measurements of taxis in San Francisco

- Data for a full day
- Note the inhomogeneous character of the representation of traffic on the network

A Hofleitner  
2009-2012

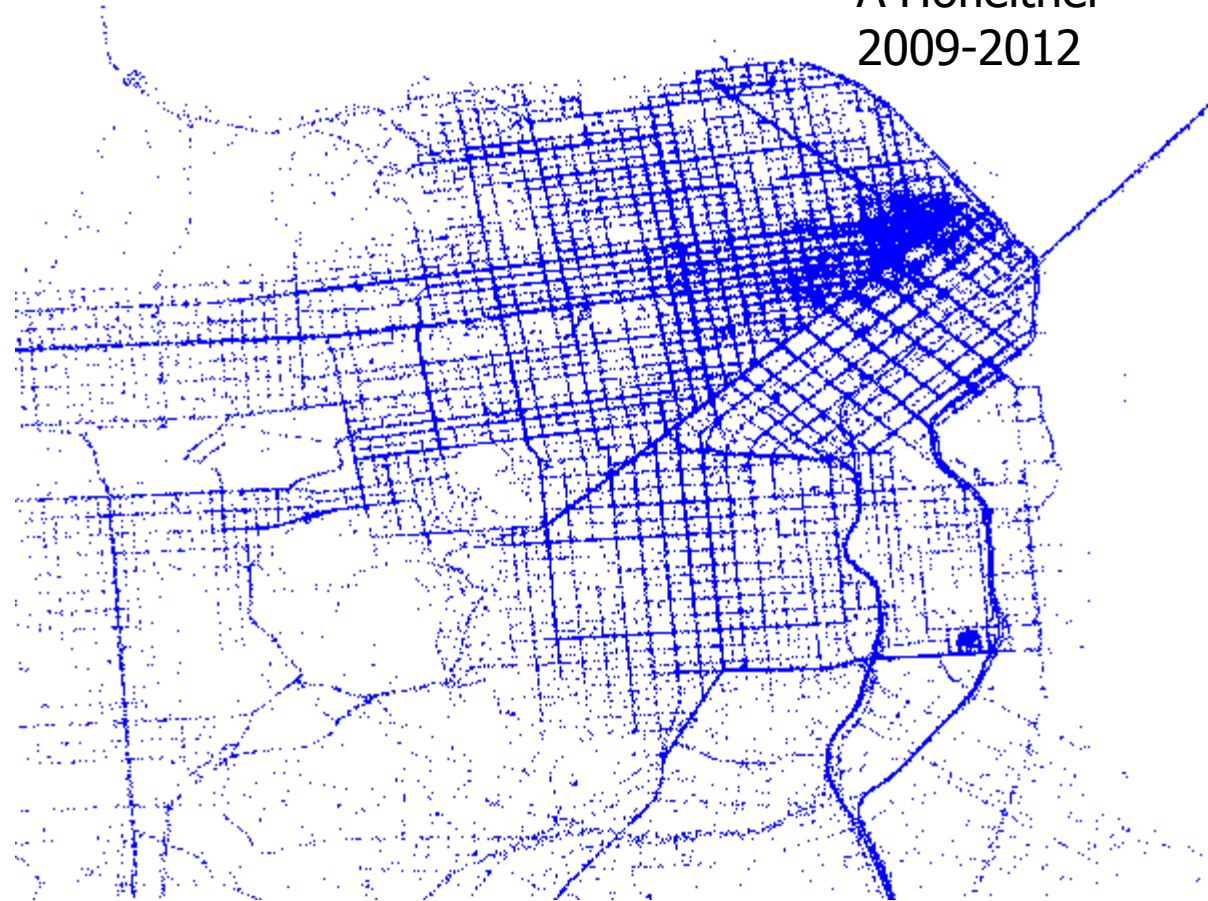

# Motivation for bidimensional modelling



---

- Complexity size of regional networks
  - Lacunary traffic data
  
  - → Aim:
    - to model global flows
    - To substitute for missing data (street network)
  
  - Very strong methodological analogy with dynamics of dense crowd
-

# A short history

---

- Tageushi and Iri 1984
    - Flow and shortest paths problems in large networks approximated as continuous bidimensional media
    - Local properties:
      - (in the tangent space at each point)
      - Capacity, speed
  - Wong (1996 → present)
    - Mainly various static assignment problems
-



## A short history (2)

---

- Pedestrian models (1996 → present)
    - Helbing, Hoogendoorn, Hughes,..
    - Kinetic models + closure + assignment
  - Daganzo, Geroliminis (2006): isotropic macroscopic fundamental diagram (behavioral law)
  - Jiang et al (2011): dynamic assignment
  - Saumtally (2011-2013): anisotropic medium + dynamic assignment
-

# Statical problems : assignment

- Statical assignment on networks (path choice)
  
- Supply-demand equilibrium Process: Wardrop principle
  - Users choose the most attractive paths
  - The attractiveness of a path is evaluated by its cost (travel time + monetary cost + ...)
  - The cost of a path is an increasing function of its traffic load (supply)
  - Paths become less attractive as they become more used (congestion)



# Equilibrium Conditions

- Wardrop (1955): the costs of used paths are equal ( $\rightarrow$  OD cost  $s_{OD}$ )
- the costs of unused paths are greater than the OD cost

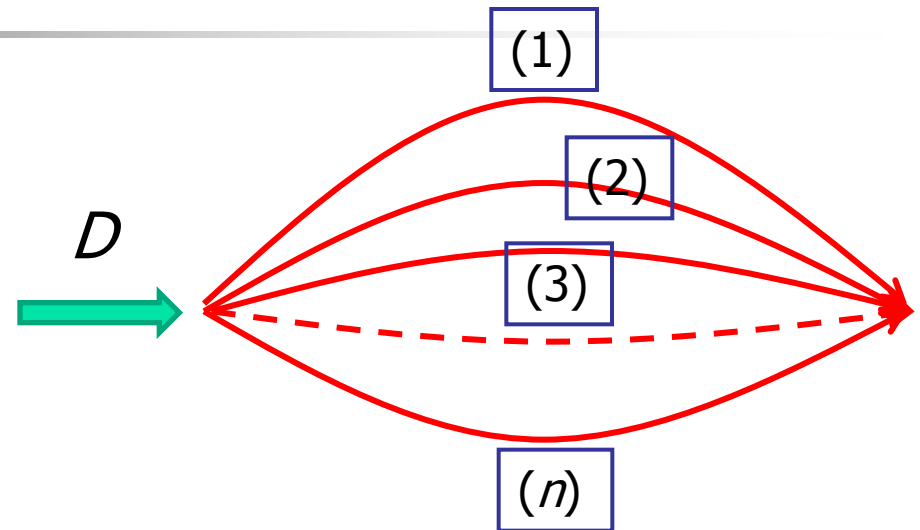

$$C_i(d_i) \stackrel{def}{=} s_{OD} \quad \text{if } d_i > 0$$

$$C_i(d_i) \geq s_{OD} \quad \text{if } d_i = 0$$

$$\sum_i d_i = D$$

# Beckman Transformation (1956)

- The solution of the assignment problem is obtained by solving an optimisation problem
  - Constraints = flow conservation constraints the graph
  - Criterion = cost of incremental formation of the equilibre

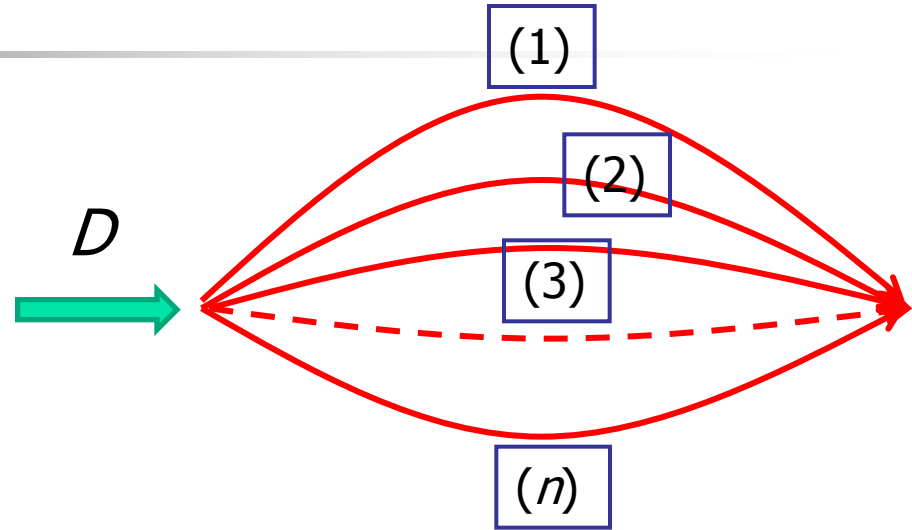

$$\begin{array}{l}
 \text{Min } \sum_{i=1, \dots, n} \int_0^{d_i} c_i(t) dt \\
 \left| \begin{array}{l}
 \sum_{i=1, \dots, n} d_i = D \\
 d_1, d_2, \dots, d_n \geq 0
 \end{array} \right.
 \end{array}$$

# Elastic demand?

- **Elastic Demand** : The travel demand is a decreasing function of the travel cost

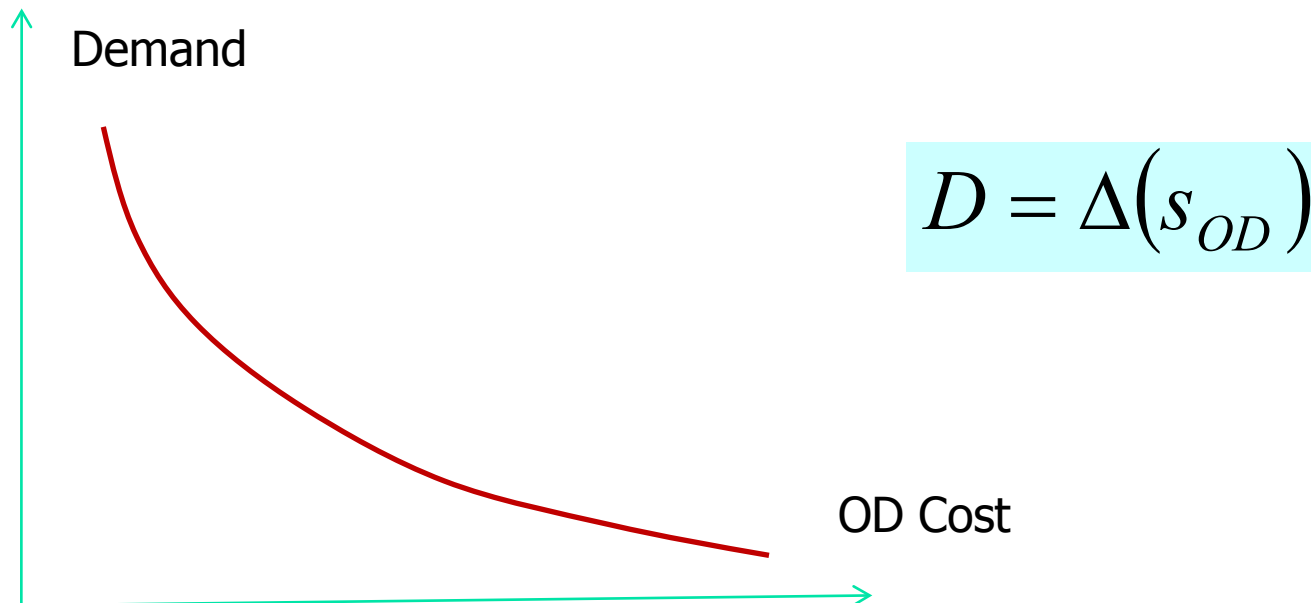

# Equilibrium with elastic demand

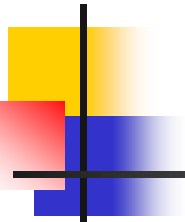

- The solution of the assignment problem is obtained again by solving an optimisation problem
  - Constraints = flow conservation constraints the graph
  - Criterion = cost of incremental formation of the equilibrium including the impact of the elasticity of the demand

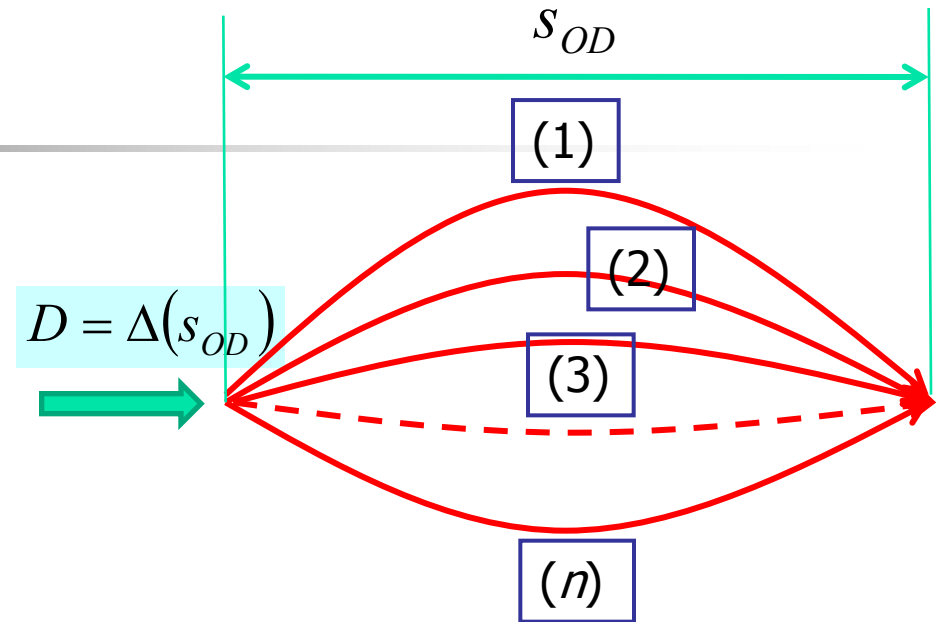

$$\text{Min } \sum_{i=1, \dots, n} \int_0^{d_i} c_i(t) dt - \int_0^D \Delta^{-1}(s) ds$$

$$\left| \begin{array}{l} \sum_{i=1, \dots, n} d_i = D \\ d_1, d_2, \dots, d_n \geq 0 \end{array} \right.$$

# A first example: static assignment in a very large network (Wong et al 1997...)

- Isotropic medium
- Pointwise source terms
  - (emissions)
  - Elastic demand
- 1 destination: CBD
  
- Conservation of traffic:
  - Divergence equation

$$\text{div}(f_m) + q_m = 0$$

$$C = a + b|f|$$

$f = (f_m)$ : flows ( $m$ )  $\rightarrow$  CBD

$$q_m = D_m(u_m)$$

$u_m = \text{OD cost: } (m) \rightarrow \text{CBD}$

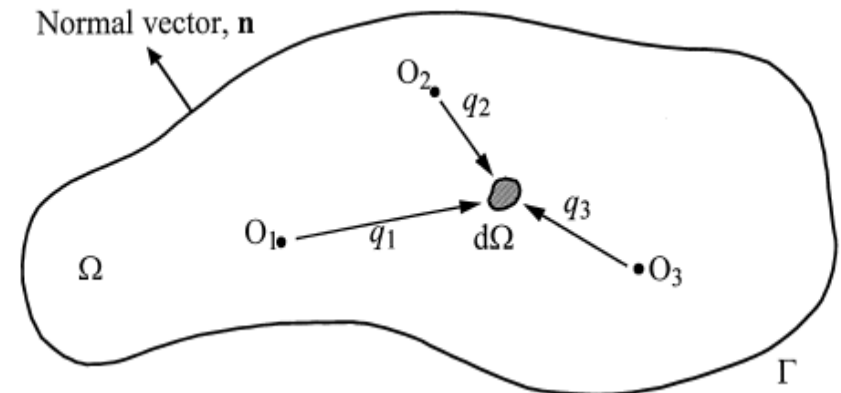

# Resolution of the model

- Beckman transformation in the continuous domain
- Minimisation of the integral of costs – integral of inverse demands
  - Constraints: conservation and BC

$$\text{Minimize}_{\mathbf{f}, \mathbf{q}} \theta(\mathbf{f}, \mathbf{q}) = \iint_{\Omega} a \sum_{m=1}^M |\mathbf{f}_m| + \frac{b}{2} \left( \sum_{m=1}^M |\mathbf{f}_m| \right)^2 - \sum_{m=1}^M \int_0^{q_m} D_m^{-1}(\xi) d\xi d\Omega$$

$$\nabla \mathbf{f}_m + q_m = 0, (x, y) \in \Omega, m = 1, 2, \dots, M,$$

$$\mathbf{f}_m \cdot \mathbf{n} = 0, (x, y) \in \Gamma, m = 1, 2, \dots, M.$$



# Qualitative Aspects of the solution

$$C_\gamma = \int_\gamma C(x, f) d\gamma(x)$$

$$C(x, f) = a + b|f|$$

$$C \frac{f_m}{|f_m|} = \nabla u_m$$

- Optimal paths: tangent to traffic flow
- Cost of optimal paths is minimal ( $= u_m$ )
- Normal to iso-values of cost

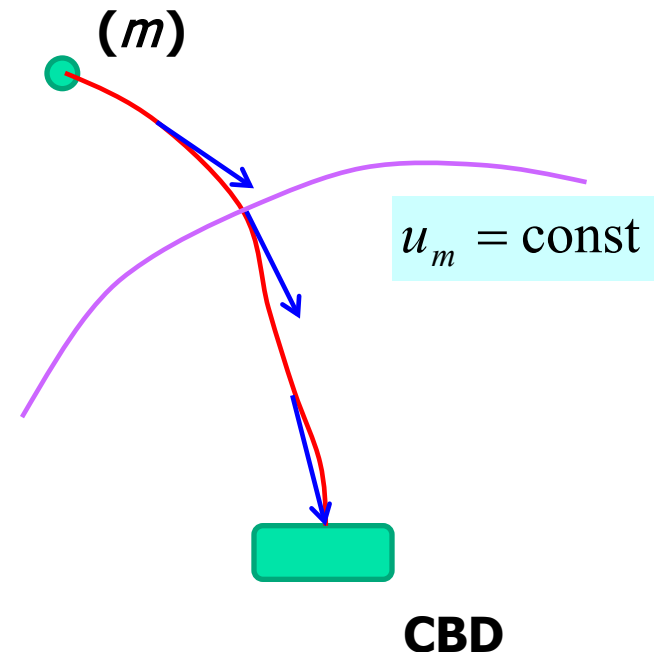

# Qualitative aspects of the solution



---

- Easily understood
  - Traffic is assigned on least cost paths
  - Given density (and costs): HJ problem
  - But costs depend on assignment
- Hence the min formulation

# Results



- Intensity of flow and iso-values of cost
- Example of application:
  - Optimal tolling

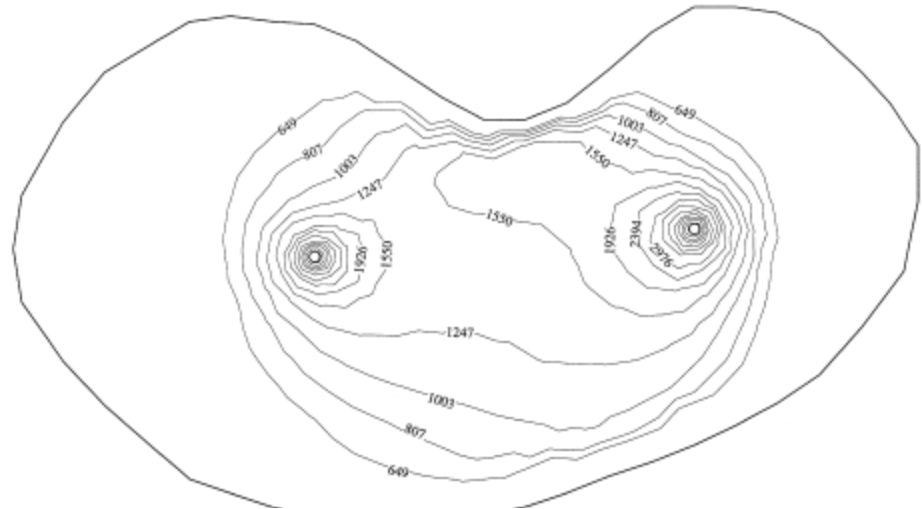

— Travel cost from CBD 1  
 ..... Travel cost from CBD 2

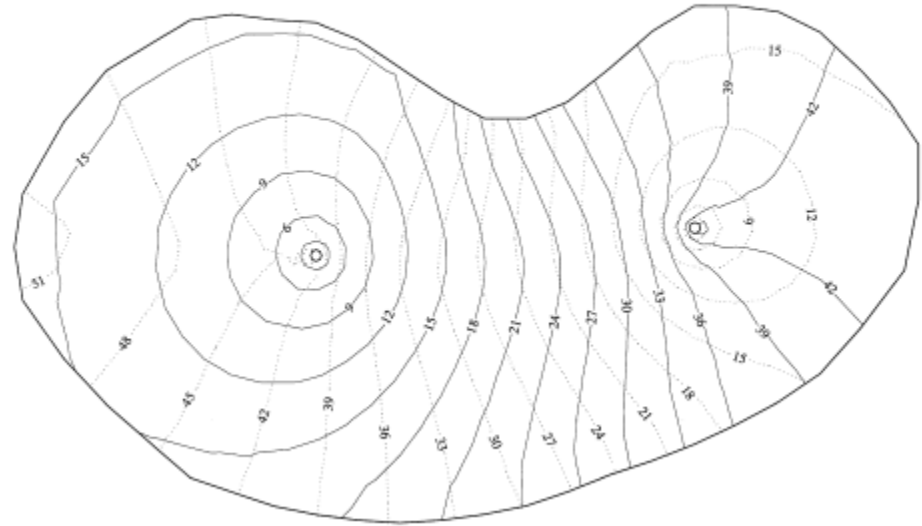
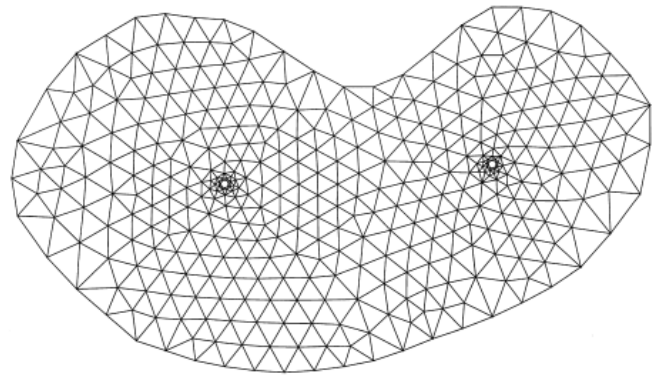

# A non isotropic model (Saumtally 2009-2012)

- privileged directions of propagation of traffic
- Locally 4 directions
- Traffic loads in those directions are estimated

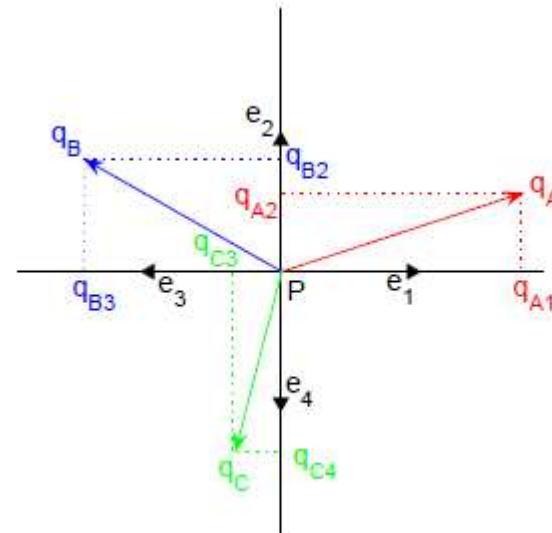
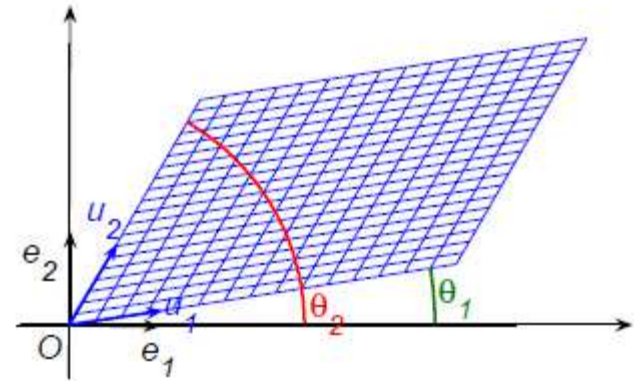

$$\sum_m \langle q_m | e_i \rangle^+ = \text{charge direction } e_i$$

# Constraints and hypotheses

- Conservation of traffic
- Traffic loads are bounded by infrastructure capacity (privileged directions of propagation)
  - Density of links x capacity
- Elastic demande (origins)
- Elastic supply (destinations)

$$\sum_{m=1}^M \langle q_m | e_i \rangle^+ \leq K_i$$

$$\text{div} q_m = \Theta_m$$

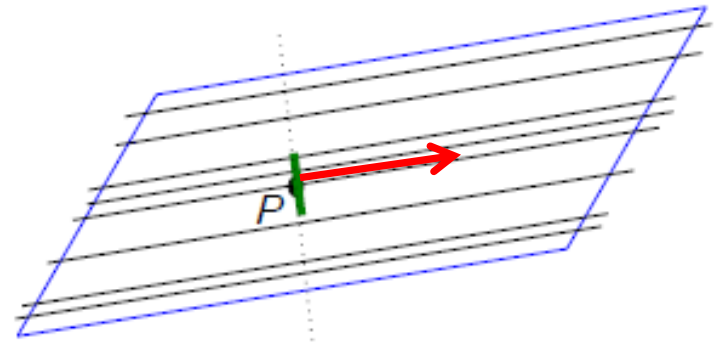

# Formulation: Beckman like ( $\rightarrow$ optimisation )

## ■ Criterion =

- integral of costs (relative to privileged directions, function of directional load)
- – integral of inverse demand functions
- + integral of inverse supply functions

$$\begin{aligned}
 \mathcal{J}_0(q, \Theta) = & \iint_{\mathfrak{A}} \sum_{i=1}^4 \int_0^{\sum_{m=1}^M \langle q_m(x,y) | e_i \rangle^+} c_i(x, y, \xi) d\xi \, dx dy \\
 & - \sum_{m=1}^M \left[ \iint_{\mathfrak{A} \setminus \mathfrak{B}_m} \int_0^{\Theta_m(x,y)} \mathcal{D}_{m,(x,y)}^{-1}(\vartheta) d\vartheta \, dx dy \right. \\
 & \left. + \iint_{\mathfrak{B}_m} \int_{\Theta_m(x,y)}^0 \mathcal{G}_{m,(x,y)}^{-1}(\vartheta) d\vartheta \, dx dy \right]
 \end{aligned}$$





# Towards models of dynamical flow: macroscopical pedestrian flow modelling



- Medium: homogeneous
- Classical variables of traffic (flow, density, speed)
- Minimise the travel cost to the destination
  
- → models very close to traffic models on a homogeneous network

# Pedestrian dynamics

- The model of Hugues (2002)
  - Dynamics flow/ density and fundamental diagram
  - Minimal cost to the destination  $\Phi$
  - Local cost of travel  $C$

$$\partial_t \rho + \operatorname{div} f = 0$$

$$f = \rho v$$

$$|v| = U(\rho, x)$$

$$C(\rho, x) \frac{f}{|f|} + \nabla \Phi = 0$$

# Resolution (Huang et al 2009)

- Given density,  $\Phi$  results by solving an eikonal equation (optimal paths)
- Flow is calculated
  - Fundamental diagram + direction of the gradient of cost to destination
- Density is calculated for next time step

$$|\nabla\Phi| = C(\rho, x)$$

$$|f| = \rho U(\rho, x)$$

$$C(\rho, x) \frac{f}{|f|} + \nabla\Phi = 0$$

$$\partial_t \rho + \operatorname{div} f = 0$$

# Modèle de Hugues (suite)

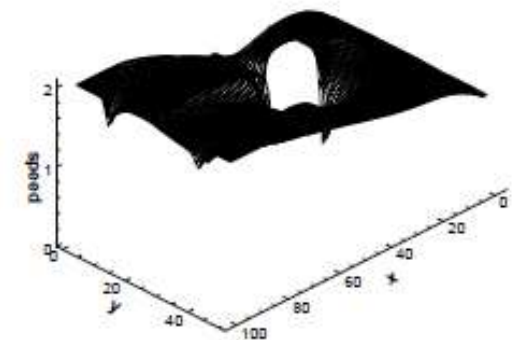
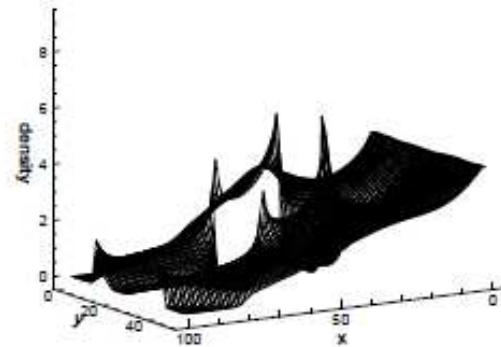
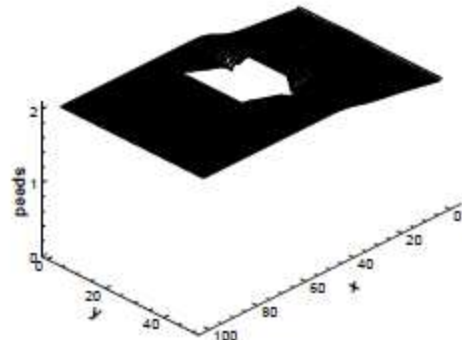
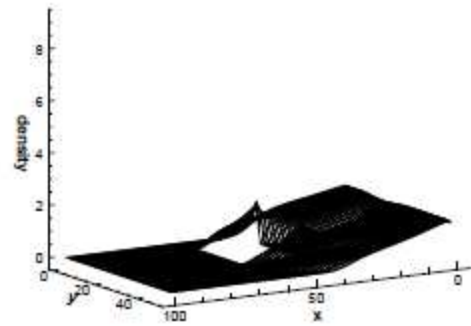
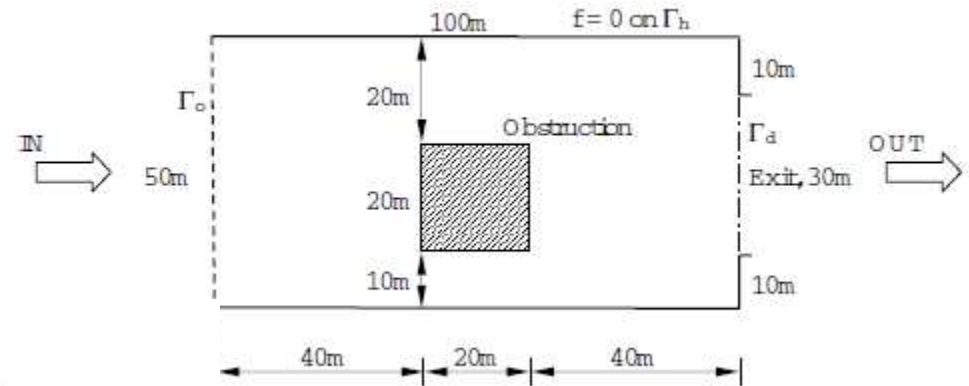

(Huang et al 2009)

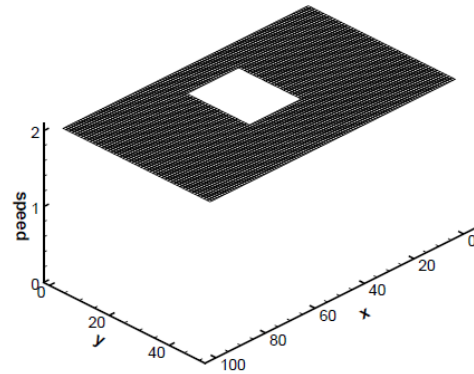
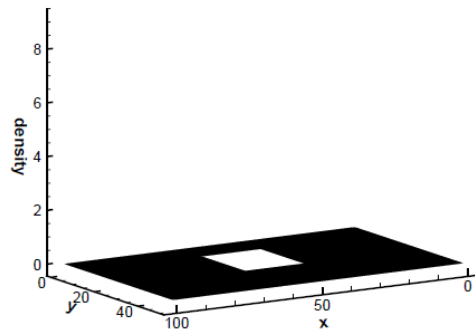
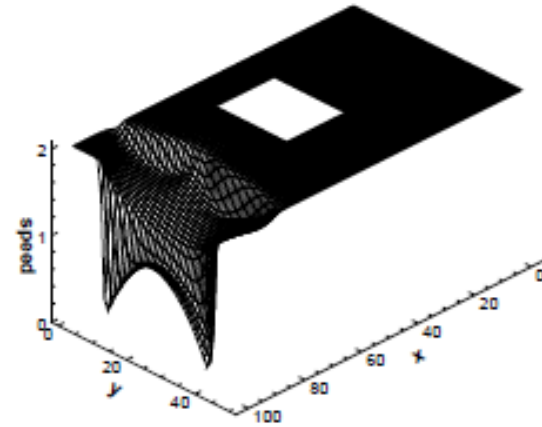
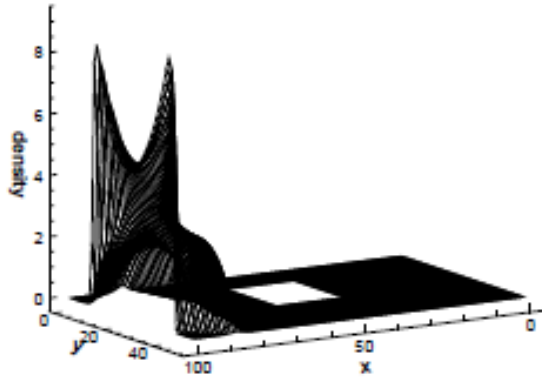
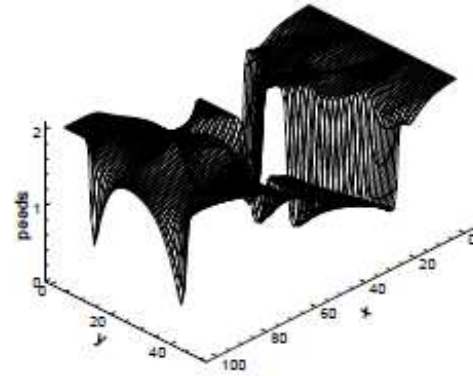
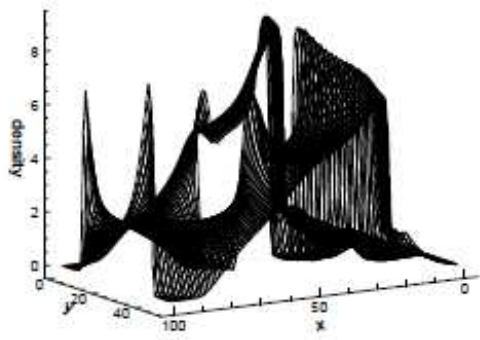
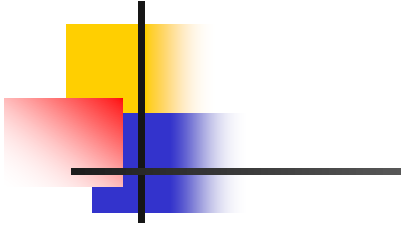



# Fundamental diagram (pedestrians)

- Many forms
- Depends on the nature of the flow
  - Channelled
  - Open space

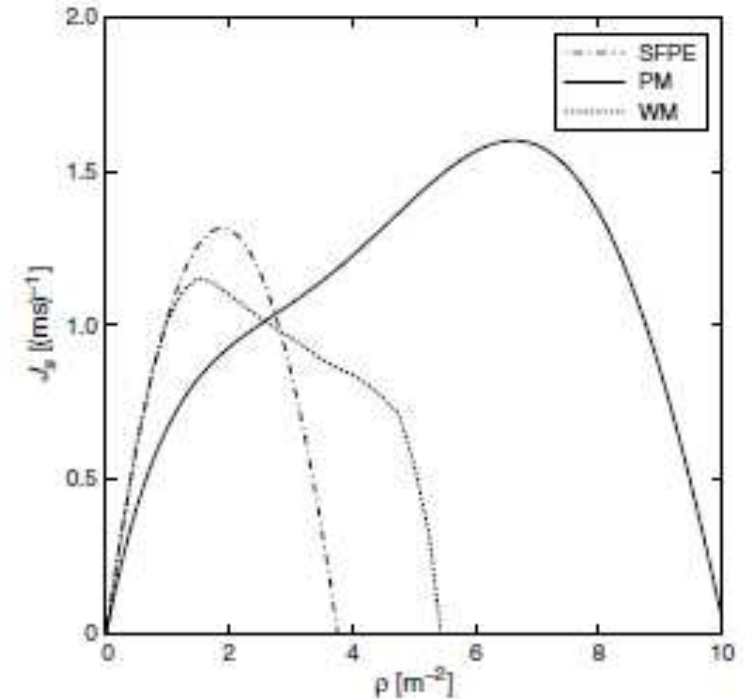
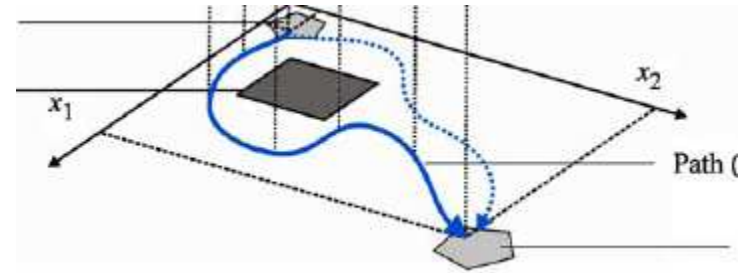

Figure 1 Fundamental Diagrams for Pedestrian Movement Through Openings and Doors According to the SFPE Handbook (SFPE, Nelson and Mowrer 2002) and the Guidelines of Predtechenskii and Milinskii (PM, 1978) and Weidmann (WM, 1993)

( Seyfried 2009 )

# The model of pedestrian dynamics of Hoogendoorn and Bovy (2004)



## ■ Basic idea

- Pedestrians while targetting their destination minimise their cost (travel time +...)
- Constraints applying to speed depend on local density, obstacles...

# Hamilton-Jacobi formulation

- The model boils down to:
  - Traffic assigned on shortest paths
  - Conservation of traffic

$$\text{Min}_v \int_{t_0}^T L(x, v, t) dt + J_{\mathfrak{S}}(x_0, t_0) \stackrel{\text{def}}{=} J(x_T, T)$$

$$\left| \begin{array}{l} \frac{dx}{dt} = v \\ v \in \mathfrak{R}(\rho(x, t), x) \\ x(t_0) = x_0, \quad x(T) = x_T \\ (x_0, t_0) \in \mathfrak{S} \end{array} \right.$$

$$\partial_t \rho + \text{div}(\rho v) = 0$$

# Hamilton-Jacobi equation

- Equation for  $V$

$$\partial_t J(x, t) = \text{Min}_{u \in \mathcal{R}(\rho(x, t), x)} [L(x, u, t) - \partial_x J(x, t) \cdot f]$$

- Hamiltonian

$$H(x, u, y, t) \stackrel{\text{def}}{=} L(x, u, t) - y \cdot u$$

$$H^0(x, y, t) \stackrel{\text{def}}{=} \text{Min}_{u \in \mathcal{R}(\rho(x, t), x)} [L(x, u, t) - y \cdot u]$$

- Hamilton-Jacobi equation + conservation

$$\partial_t \rho + \text{div}(\rho v) = 0$$

$$\partial_t J(x, t) = H^0(x, \partial_x J(x, t), t)$$

$$V|_{\mathfrak{S}} = J|_{\mathfrak{S}}$$

# Illustration

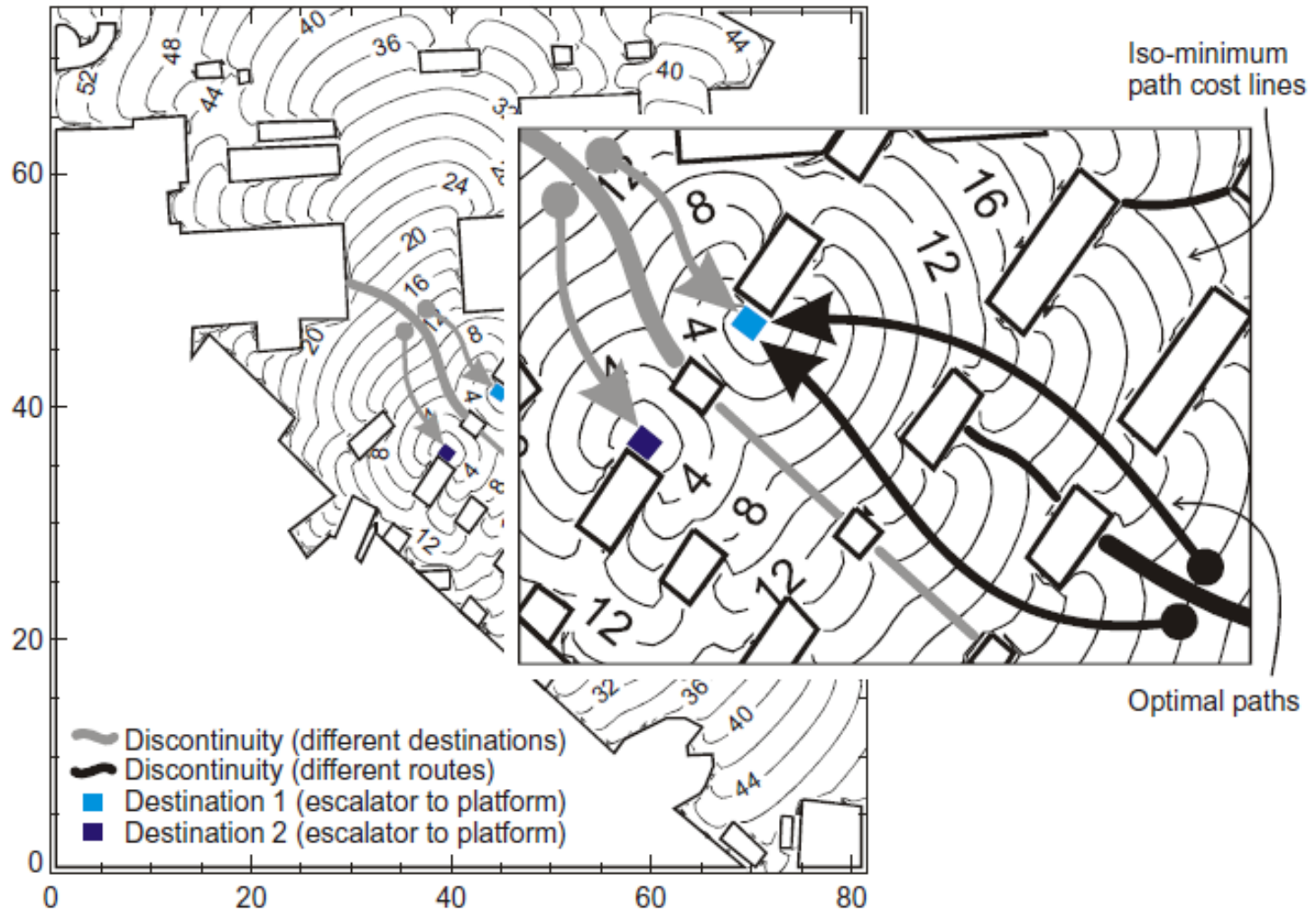

# The model for dynamic assignment in networks by Jiang et al (2011)

## ■ Principles

- Users chose the minimal cost path
- The module of speed depends on density (fundamental diagram)
- The cost depends on traffic density
- Traffic is conserved

$$C = \kappa \left( \frac{1}{|v|} + \Pi(\rho) \right) = \kappa \left( \frac{1}{U(\rho)} + \Pi(\rho) \right)$$

$$\partial_t \rho + \operatorname{div}(\rho v) = 0$$

$$|v| = U(\rho),$$

$$|q| = \rho |v| = \rho U(\rho) \stackrel{\text{def}}{=} F(\rho)$$

# Structure of the model

- fundamental diagram :
- Calculation of optimal trajectories (cost :  $\Phi$ )

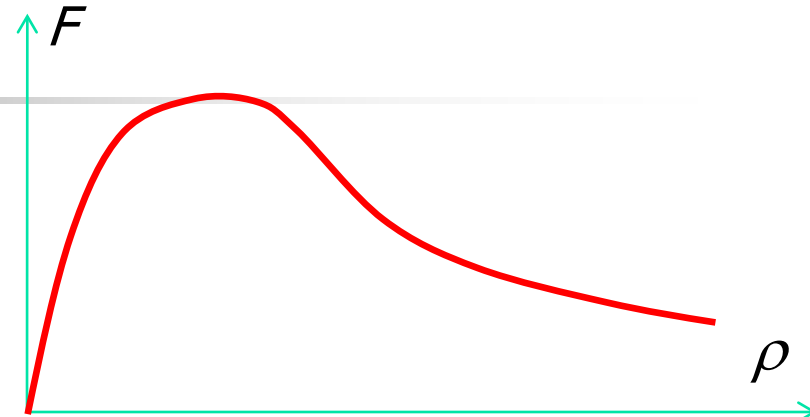

$$\text{Min}_{v(\cdot)} \int_{t_0}^{t_D} C(x, v) |v| dt + \Phi_D(x_0, t_0) \stackrel{\text{def}}{=} \Phi(x_T, T)$$

$$\left| \begin{array}{l} \frac{dx}{dt} = v \\ |v| = U(\rho(x, t)) \\ x(t_0) = x_0, \quad x(t_D) = x_D \\ x_D \in \mathfrak{I}_D \end{array} \right.$$

# Structure of the model (continued)

- Model very close to Hoogendoorn-Bovy
- Problem of constructing optimal trajectories is solved by Hamilton-Jacobi.
- Resulting system:

$$\partial_t \rho + \operatorname{div}(\rho v) = 0$$

$$v = -U(\rho) \frac{\partial_x \Phi}{|\partial_x \Phi|}$$

$$\partial_t \Phi = U(\rho)(C(\rho) - |\partial_x \Phi|)$$



# Some results: density

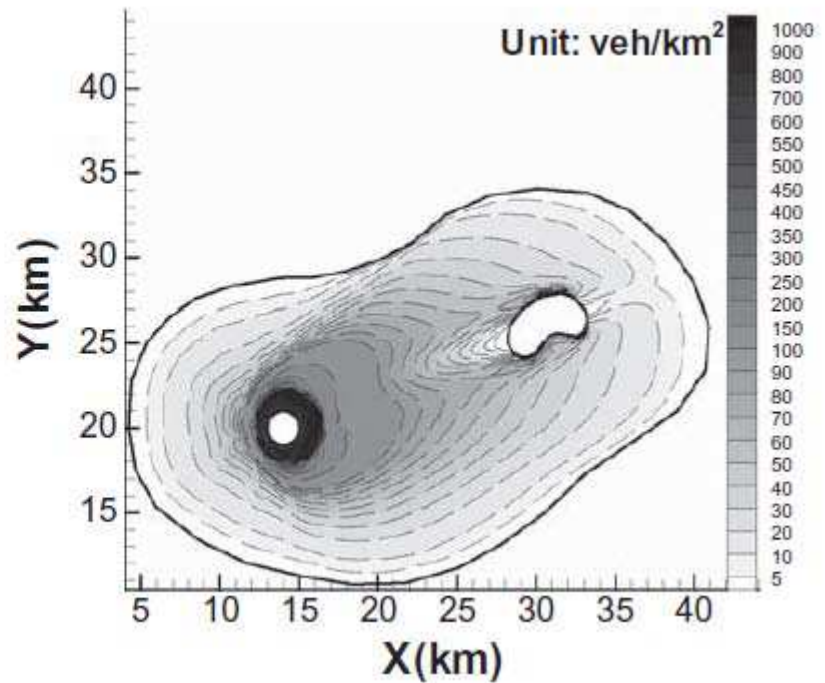
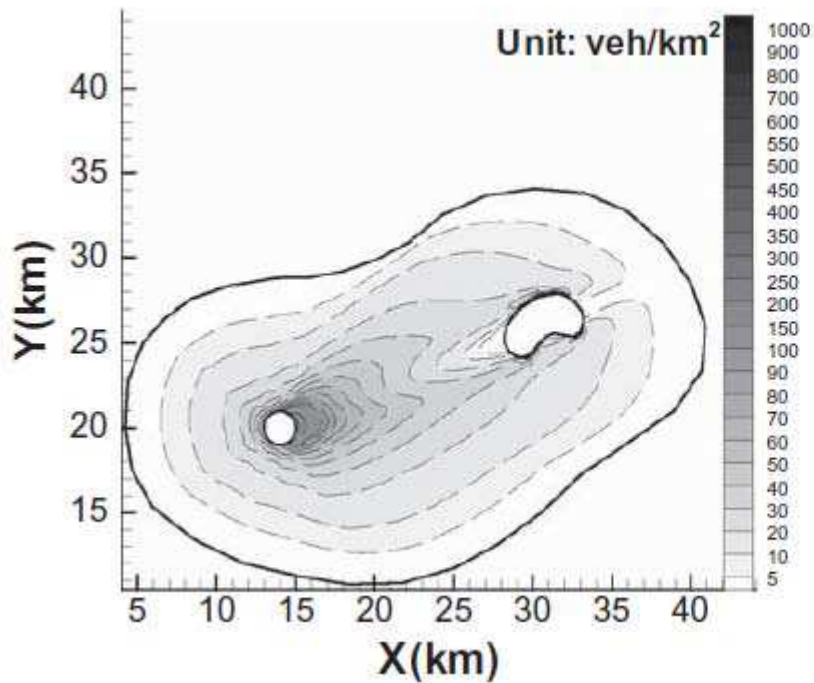

# Some results: speed

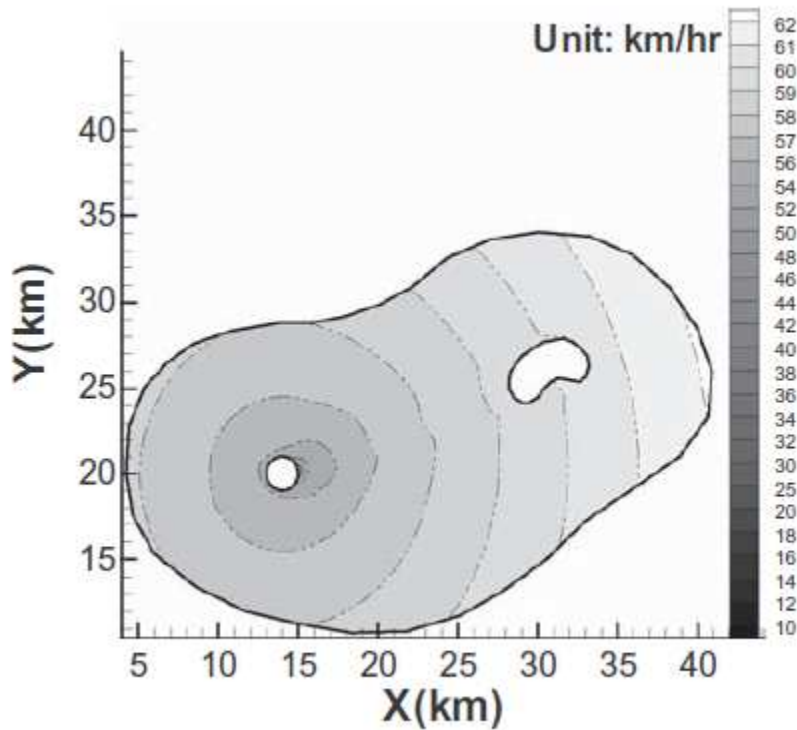

(a) 6:30 a.m.

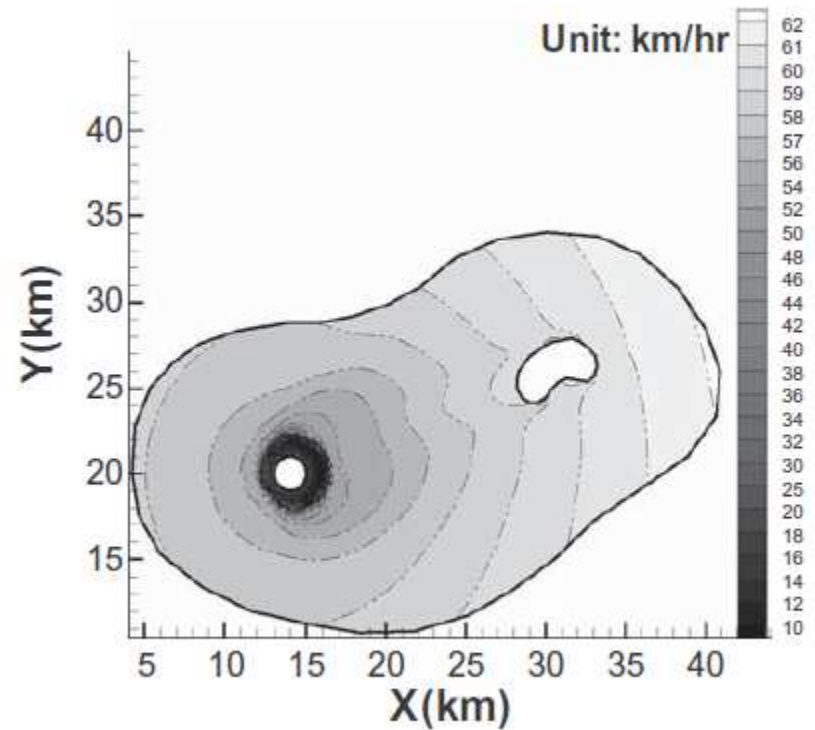

(b) 7:30 a.m.

# Some results: OD costs

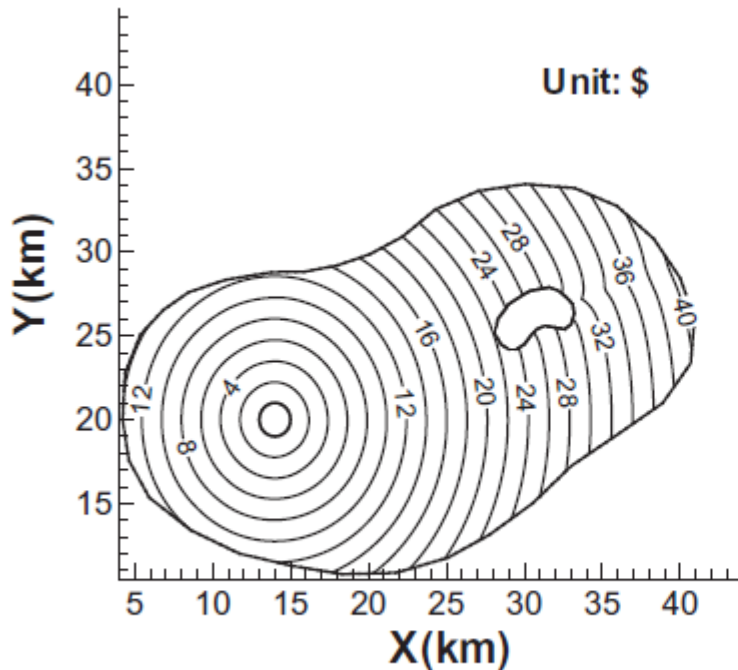

(a) 6:30 a.m.

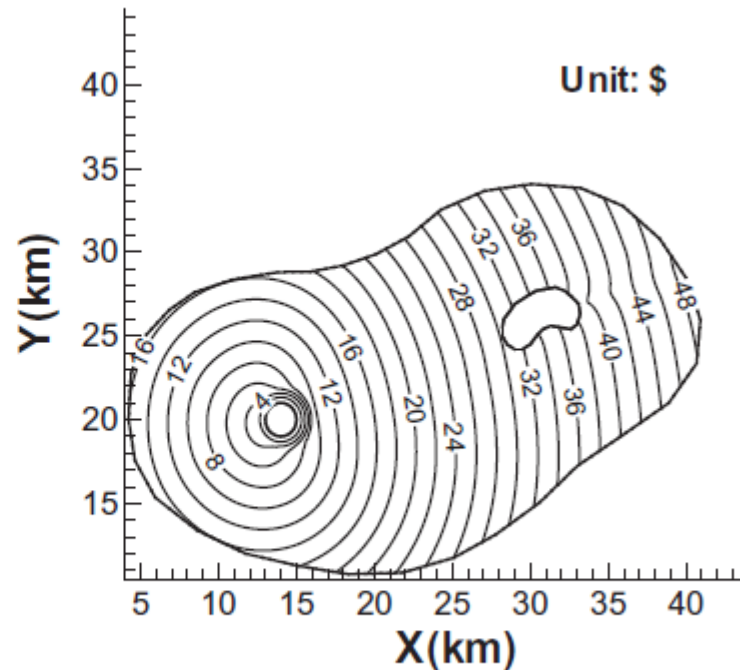

(b) 7:30 a.m.



# Comment

---

- From a modelling point of view
  - Pedestrian:
    - homogeneous medium + obstacles
  - Traffic on large networks:
    - Heterogeneous medium

# Macroscopic fundamental diagram (Daganzo Geroliminis 2007 → )

- Idea: macroscopic relationship between number of vehicles in a zone and in- and out-flows
  - Limitation : requires homogeneity in space and time (slow varying demand)

# Estimation

- Simplest is Edie procedure

- Link flow = total distance travelled / length x time
- Link density = total time spent / length x time
- Flow = weighted link flows
- Density = weighted link densities

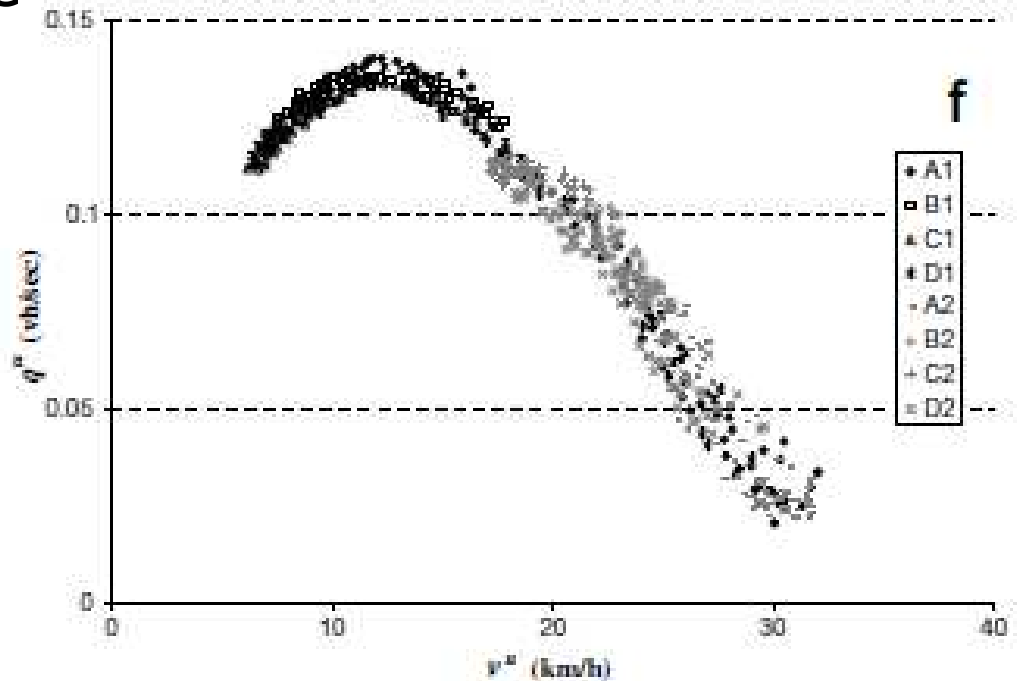



# Possible use

---

- Macroscopic (network level) traffic flow model
  - Dividing network into homogeneous isotropic cells
  - Combine with anisotropic models

# Network modeling

- Possibility: both
  - Anisotropic areas
  - Isotropic areas
  - (ex Barcelona)





# Dynamic bidimensional traffic model: non isotropic case (Saumtally Lebacque 2011-2013)

- Dynamic assignment: expressed by assignment coefficients
- The network is characterised by its macroscopic properties
  - Density of links
  - Capacity, Supplies, demands

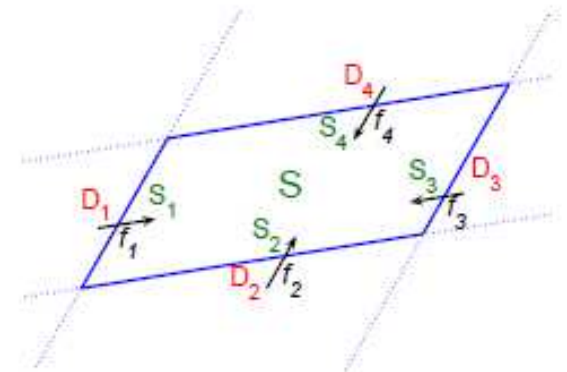
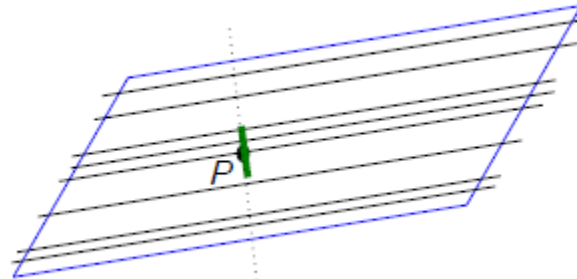
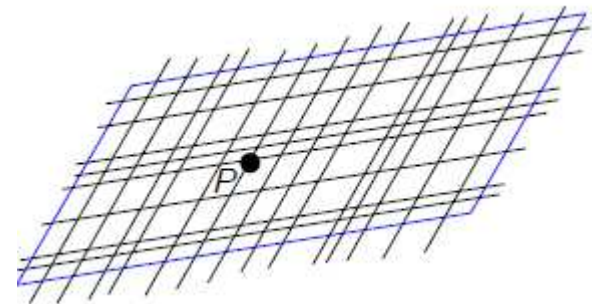

# Recall: supply / demand $\Sigma_e$ $\Delta_e$

- Are equilibrium functions defined based on the fundamental diagram (Lebacque, 1993-1996)

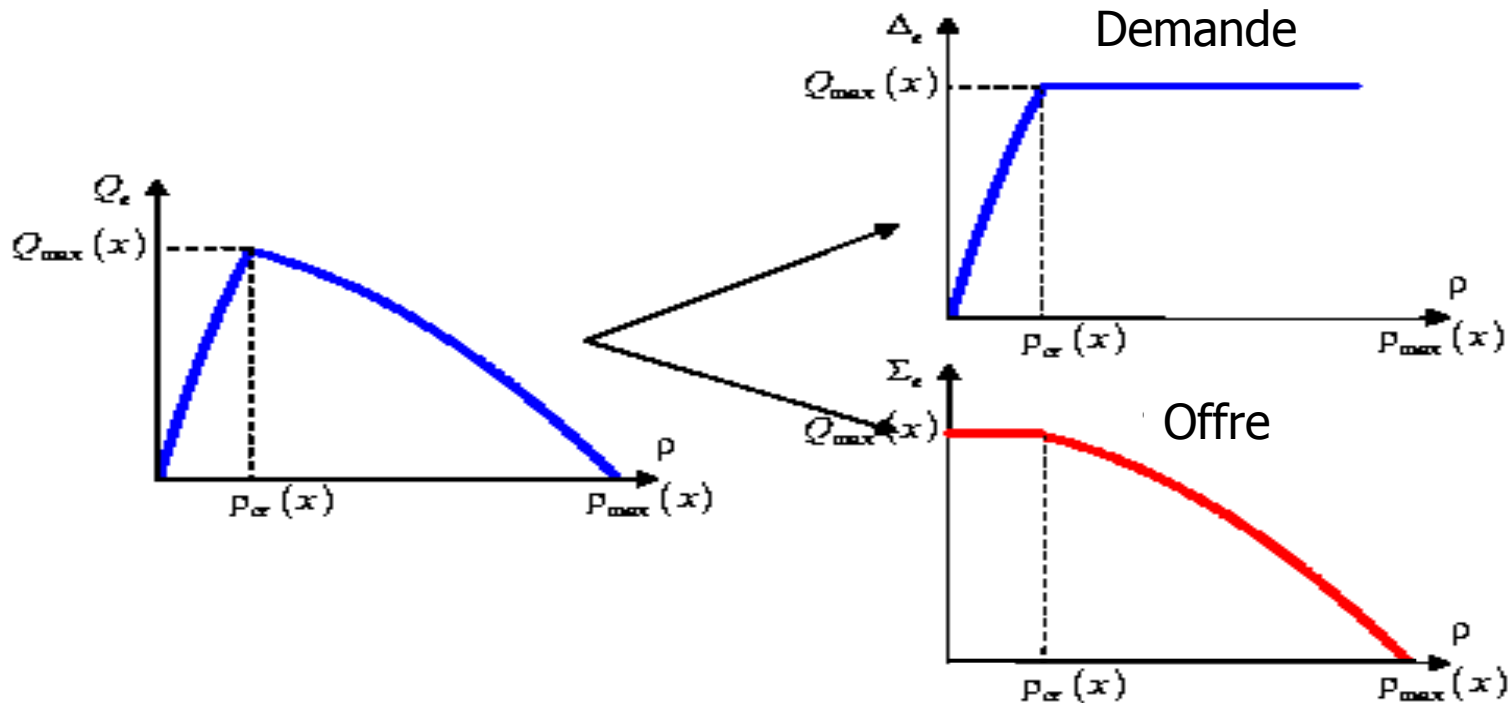



# Min formula

---

- Local traffic supply and demand:

$$\Sigma(x, t) = \Sigma_e(\rho(x+, t), x +)$$

$$\Delta(x, t) = \Delta_e(\rho(x-, t), x -)$$

- The **min formula**

$$Q(x, t) = \text{Min} [\Sigma(x, t), \Delta(x, t)]$$

- **Usage:** numerical schemes, boundary conditions a  
→ **intersections models**

# Flows and assignment coefficients

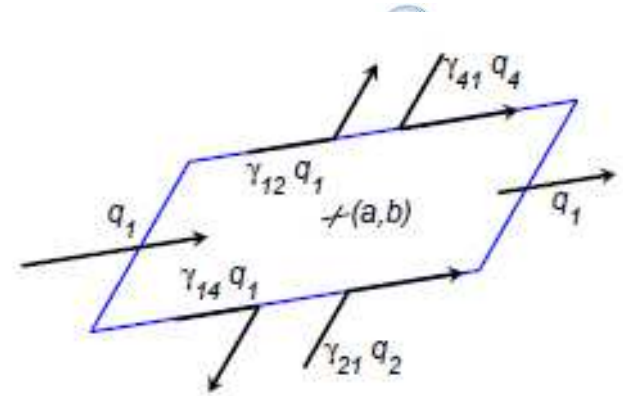

- Assignment coefficients are fractions of turning movements
- Reactive dynamic assignment: assignment coefficients  $\leftarrow$  a priori choice + dynamic processed (information etc)
- Vehicle conservation + « unzooming »  $\rightarrow$  flows and coefficients must be consistent

$$\sum_j \gamma_{ij} = 1 \quad \forall i$$

$$\gamma_{ij} \geq 0 \quad \forall i, j$$

$$\sum_i \gamma_{ij} q_i = q_j \quad \forall j$$

# Conservation equations

- Balance in each cell per directional category

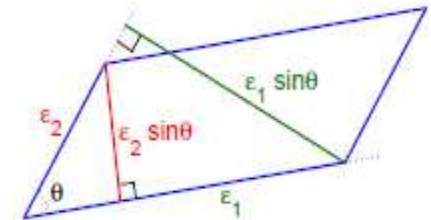
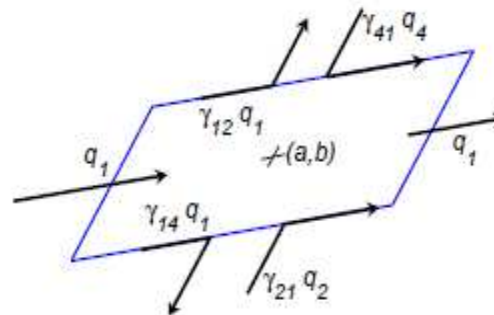

$$\begin{aligned}
 N_1(t + \Delta t) - N_1(t) = & \\
 & q_1\left(a - \frac{\epsilon_1}{2}, b, t\right) \lambda_1\left(a - \frac{\epsilon_1}{2}, b\right) \epsilon_2 \sin \theta \Delta t - q_1\left(a + \frac{\epsilon_1}{2}, b, t\right) \lambda_1\left(a + \frac{\epsilon_1}{2}, b\right) \epsilon_2 \sin \theta \Delta t \\
 & + \gamma_{21}\left(a, b - \frac{\epsilon_2}{2}\right) q_2\left(a, b - \frac{\epsilon_2}{2}, t\right) \lambda_2\left(a, b - \frac{\epsilon_2}{2}\right) \epsilon_1 \sin \theta \Delta t \\
 & - \gamma_{14}\left(a, b - \frac{\epsilon_2}{2}\right) q_1\left(a, b - \frac{\epsilon_2}{2}, t\right) \lambda_2\left(a, b - \frac{\epsilon_2}{2}\right) \epsilon_1 \sin \theta \Delta t \\
 & + \gamma_{41}\left(a, b + \frac{\epsilon_2}{2}\right) q_4\left(a, b + \frac{\epsilon_2}{2}, t\right) \lambda_2\left(a, b + \frac{\epsilon_2}{2}\right) \epsilon_1 \sin \theta \Delta t \\
 & - \gamma_{12}\left(a, b + \frac{\epsilon_2}{2}\right) q_1\left(a, b + \frac{\epsilon_2}{2}, t\right) \lambda_2\left(a, b + \frac{\epsilon_2}{2}\right) \epsilon_1 \sin \theta \Delta t.
 \end{aligned}$$

- Yields a system of conservation equations

$$\begin{aligned} \partial_t \rho_1 + \partial_x f_1 + \partial_y \left( \frac{f_2 \gamma_{21} - f_4 \gamma_{41}}{2} + \frac{\lambda_2}{\lambda_1} \frac{f_1 \gamma_{12} - f_1 \gamma_{14}}{2} \right) &= 0, \\ \partial_t \rho_2 + \partial_x \left( \frac{f_1 \gamma_{12} - f_3 \gamma_{32}}{2} + \frac{\lambda_1}{\lambda_2} \frac{f_2 \gamma_{21} - f_2 \gamma_{23}}{2} \right) + \partial_y f_2 &= 0, \\ \partial_t \rho_3 + \partial_x (-f_3) + \partial_y \left( \frac{f_2 \gamma_{23} - f_4 \gamma_{43}}{2} + \frac{\lambda_2}{\lambda_1} \frac{f_3 \gamma_{32} - f_3 \gamma_{34}}{2} \right) &= 0, \\ \partial_t \rho_4 + \partial_x \left( \frac{f_1 \gamma_{14} - f_3 \gamma_{34}}{2} + \frac{\lambda_1}{\lambda_2} \frac{f_4 \gamma_{41} - f_4 \gamma_{43}}{2} \right) + \partial_y (-f_4) &= 0. \end{aligned}$$

- Expression: variation of densities as function of flows
- Why this choice: we cannot disaggregate traffic flows per OD
  - Data?
  - Non unicity of path assignment...

# Behavioral equations? And discretisation

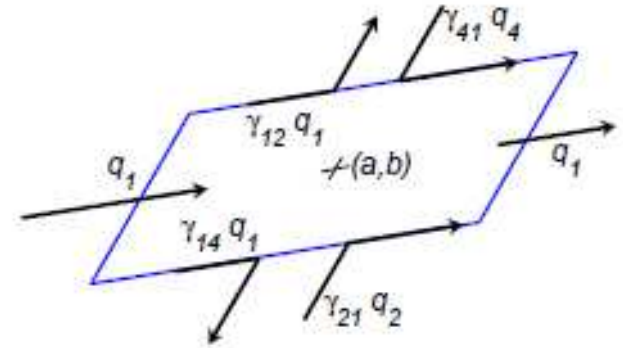
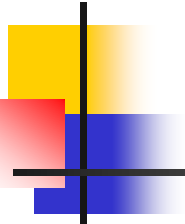

## Idea:

- Consider each cell as an intersection
  - With in- and out-flows
  - With assignment coefficients
  - With an internal state disaggregated per movement
- Apply GSOM (Generic second order modelling) methodology

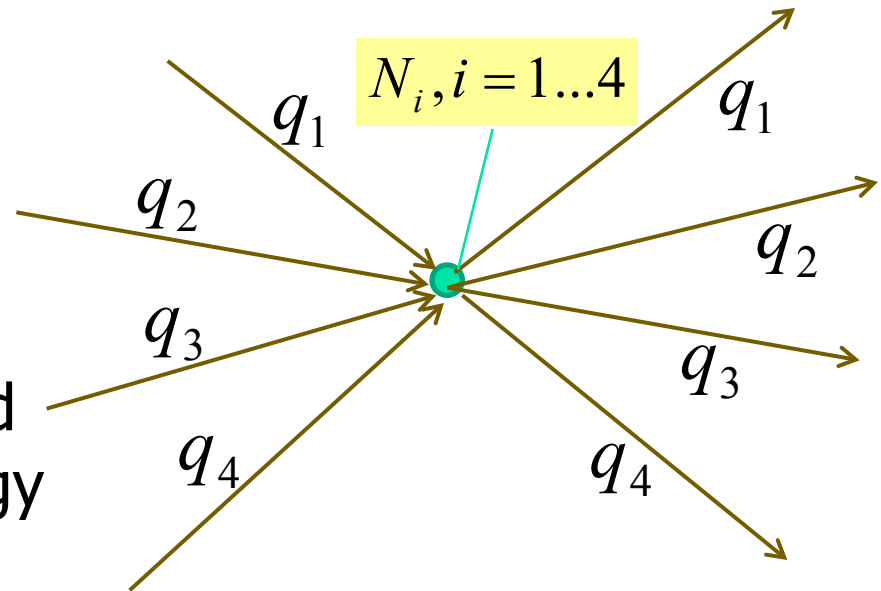

# Internal state intersection model

(Lebacque Khoshyaran 1998-2002-2005-2009)

- Application to
  - LWR = conservation law for density + FD
  - GSOM = LWR + driver attribute dynamics (OD, vh type, stochastic perturbation, behavior, cold start engine, pv mode as taxis etc)
  
- Intersection  $\Leftrightarrow$  "buffer" between upstream and downstream boundary conditions (demands resp supplies)

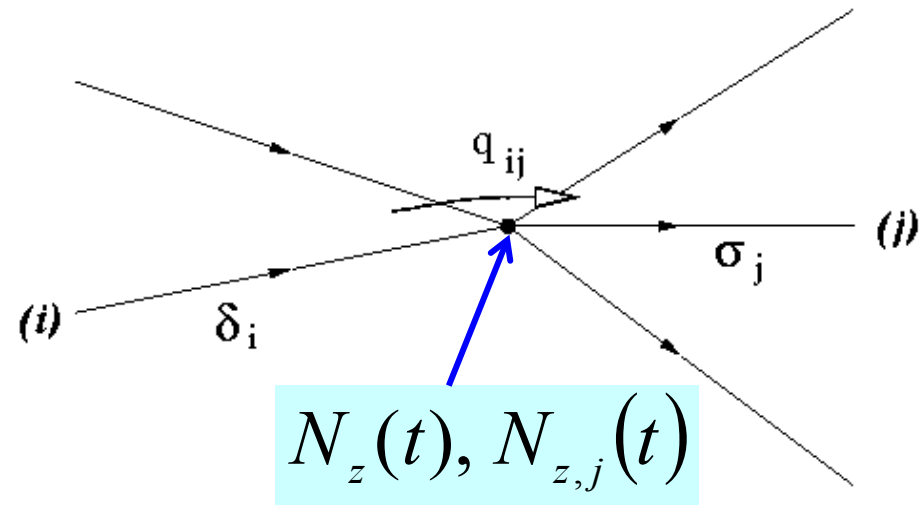



# Supply, Demand of an intersection

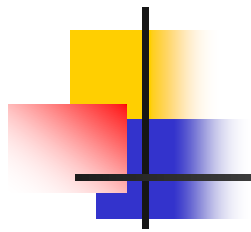

Node demand

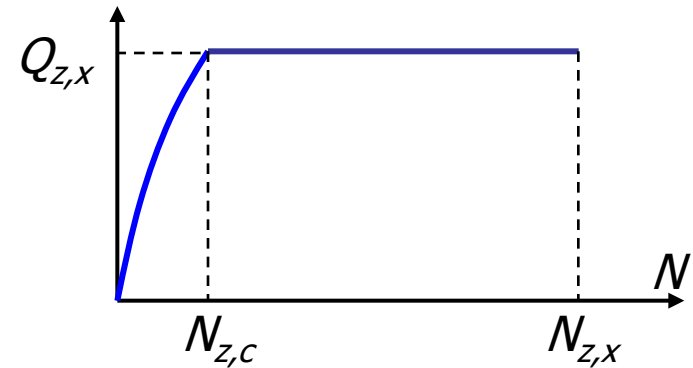

- Main parameters

$Q_{z,x}$  : through - flow capacity

$N_{z,x}$  : storage capacity

$N_{z,c}$  : critical number of vhs

Node supply

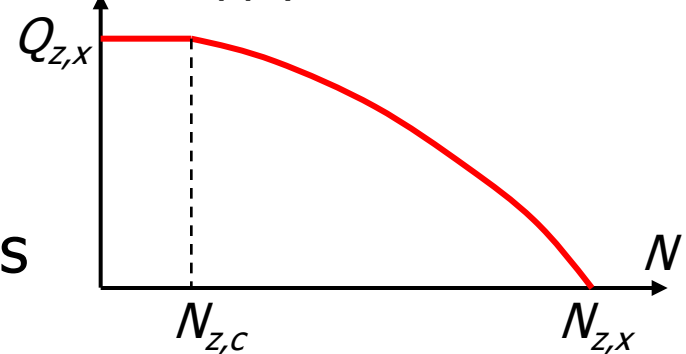

- Demand can be modified to include traffic hysteresis
- Possible: partial demands and supplies per node exit resp entry points

# Internal state intersection model

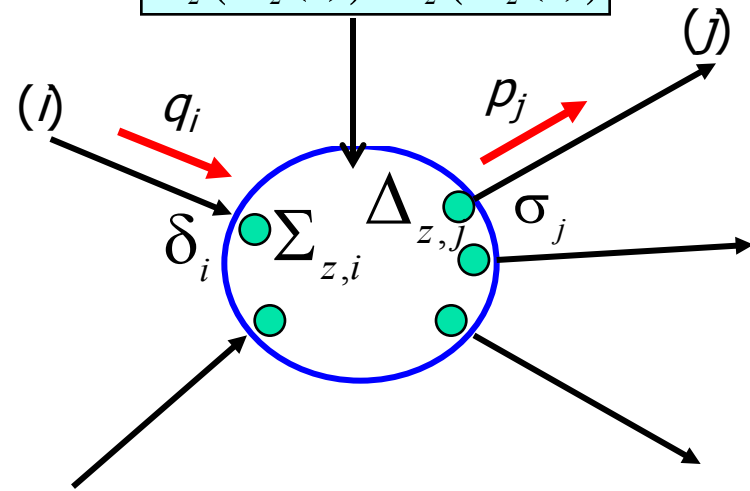
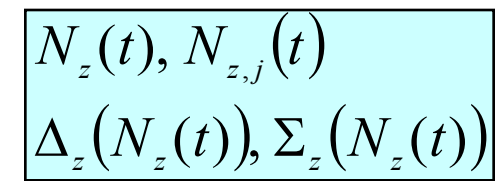
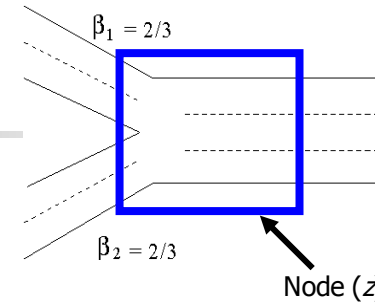
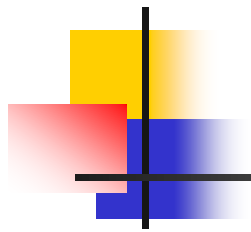

- Intersection supply is disaggregated per entry

$$\Sigma_{z,i}(t) = \beta_i \Sigma_z(N_z(t))$$

- Intersection demand is disaggregated per exit

$$\Delta_{z,j}(t) = \frac{N_{z,j}(t)}{N_z(t)} \Delta_z(N_z(t))$$

- Flow = Min (demand, supply)

$$q_i(t) = \text{Min}[\delta_i(t), \Sigma_{z,i}(t)]$$

$$p_j(t) = \text{Min}[\Delta_{z,j}(t), \sigma_j(t)]$$

# Internal state intersection model: dynamics

- Min formula for flows
- Conservation Equation for vehicles stored in the node (per category)
- Assignment coefficients (external)

$$q_i(t) = \text{Min}[\delta_i(t), \Sigma_{z,i}(t)] = \text{Min}[\delta_i(t), \beta_i \Sigma_z(N_z(t))]$$

$$p_j(t) = \text{Min}[\Delta_{z,j}(t), \sigma_j(t)] = \text{Min}\left[\frac{N_{z,j}(t)}{N_z(t)} \Delta_z(N_z(t)), \sigma_j(t)\right]$$

$$\frac{dN_{z,j}(t)}{dt} = -p_j(t) + \sum_i \gamma_{ij}(t) q_i(t)$$

$$N_z(t) = \sum_j N_{z,j}(t)$$

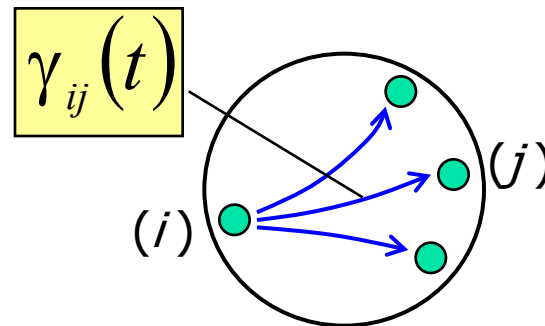

# Bi-dimensional behavioral law



- Define directional supplies and demands  $\leftarrow$  supplies and demands of the links in the cell

- Flows result from the Min formula  $\leftarrow$  supplies and demands of the neighbouring cells

- Color codes :
  - Orange = supply
  - Green = demand

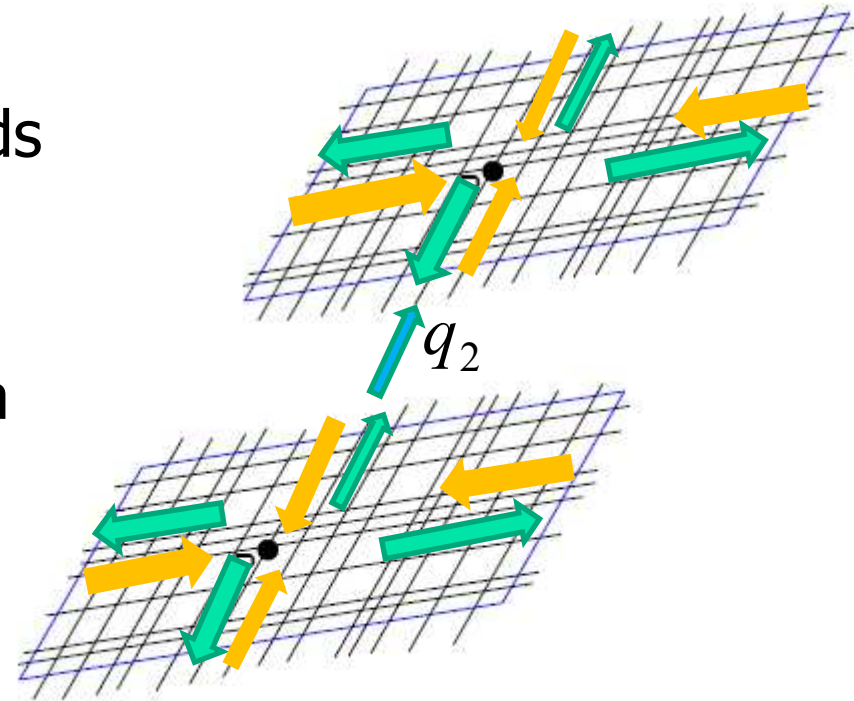



# Perspectives

---

- Couple bidimensional model with graph GSOM model (main roads with data= graph)
  - → multiscale meso/macro models
- Integrate data notably lagrangian (trajectories, travel times, passage times)
  - Trajectories = optimal paths
  - travel times = costs



# Projects

---

- French national science foundation
  - SUD, Trafipollu, HjNet
  - SystemX / MIC
- Contracts
  - DirNord, Dirif
- Platform:
  - MAGISTER

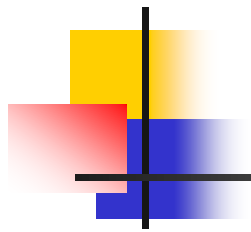

# Briques pour les fonctions offre et demande

- Par arc → par direction

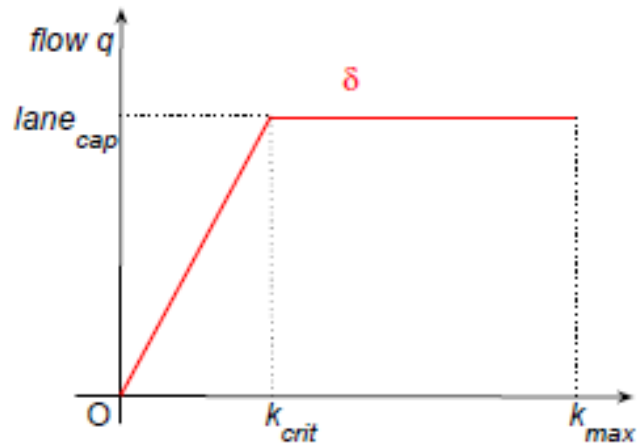

$$D_1 = \lambda_1 \delta_1 \left( \frac{\rho_1}{\lambda_1} \right)$$

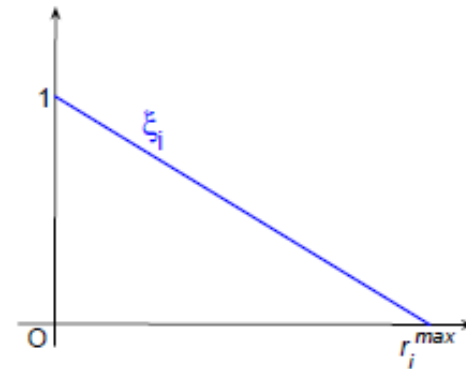

$$S_1 = \lambda_1 K_c \xi_1 \left( \frac{\rho_1}{\lambda_1} \right) \xi_2 \left( \frac{\rho_2}{\lambda_2} \right) \xi_4 \left( \frac{\rho_4}{\lambda_4} \right)$$



# Expériences reproductibles

- Expériences (piétons, Hoogendoorn, Daamen, Bovy)

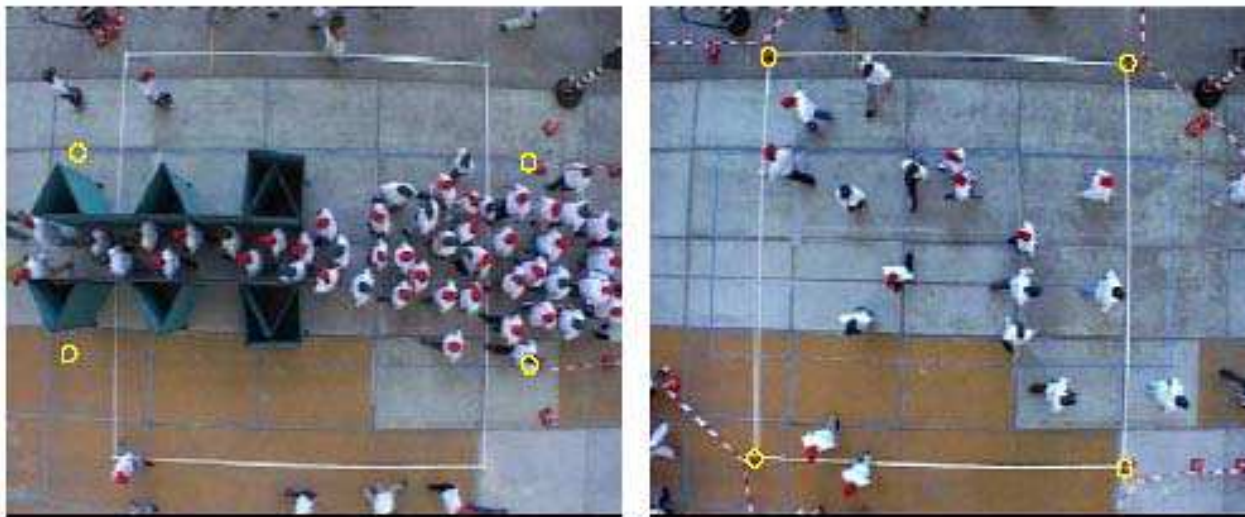
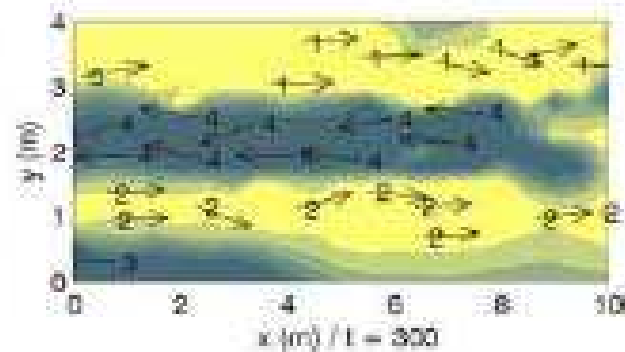
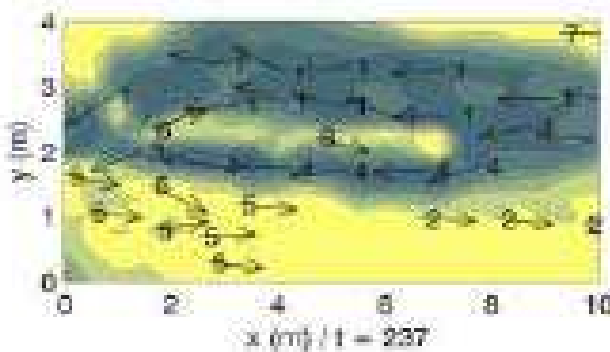
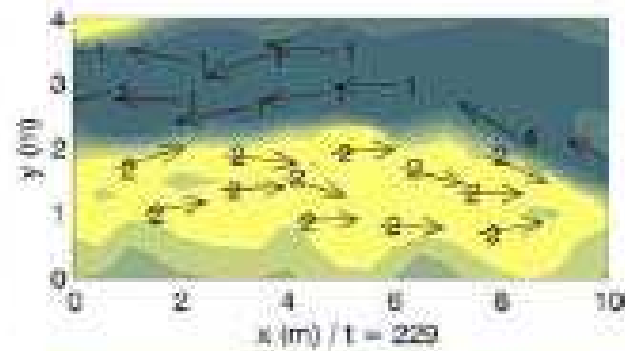
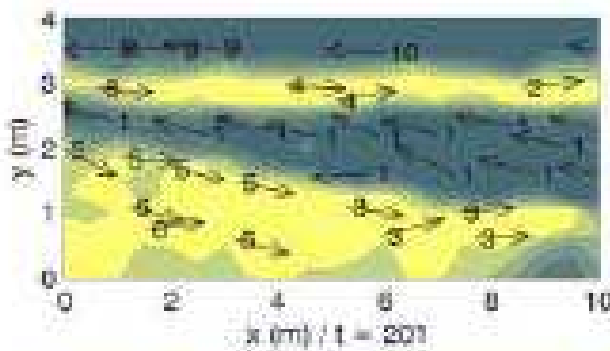

Figure 1 Examples of pedestrian experiments; a) narrow bottleneck experiment, and b) four-directional crossing flow experiment. Yellow circles (and demarcation on the floor) indicate the respective walking areas. The figure also shows the so-called pincushion distortion and the slight rotation of the camera (around 1%).

# Modèle mathématique (affectation + écoulement 2-D)

- EdP Hoogendoorn



# Exemple: dynamique de piétons

- Mouvement des piétons = **compromis** entre:
  - Évitement obstacles
  - Longueur et durée du trajet
  - destination

$$\begin{cases}
 \mathcal{J}(x, t) = \min \int_t^{t_d} |v(s)| ds \\
 \dot{y}(s) = v(s) \quad \forall s \in [t, t_d] \\
 y(t) = x \\
 y(t_d) \in \Gamma_d \\
 v(s) \in \Xi(y(s)) \quad \forall s \in [t, t_d]
 \end{cases}$$

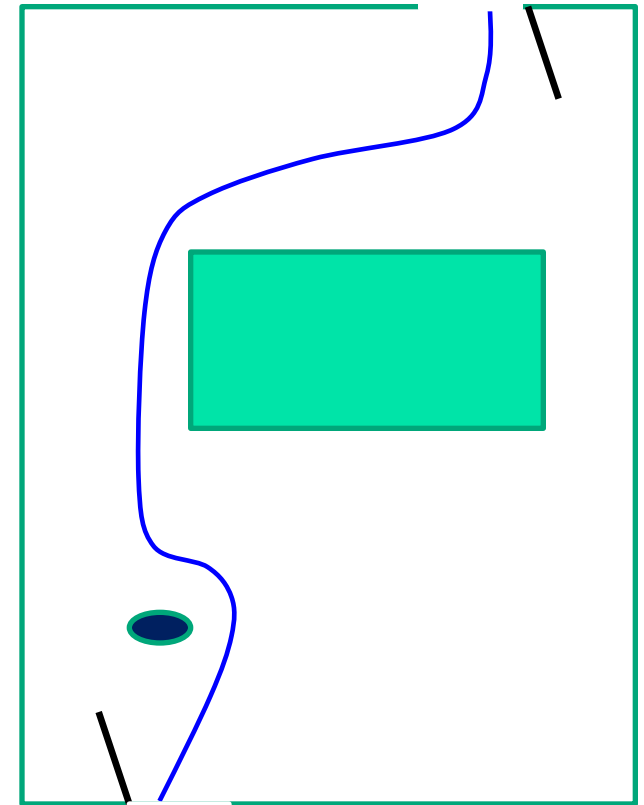

# Dynamique de piétons

- Modèle plus sophistiqué (Hoogendoorn, Bovy):
  - équation dynamique pour la densité des piétons +
  - chemin de coût minimum

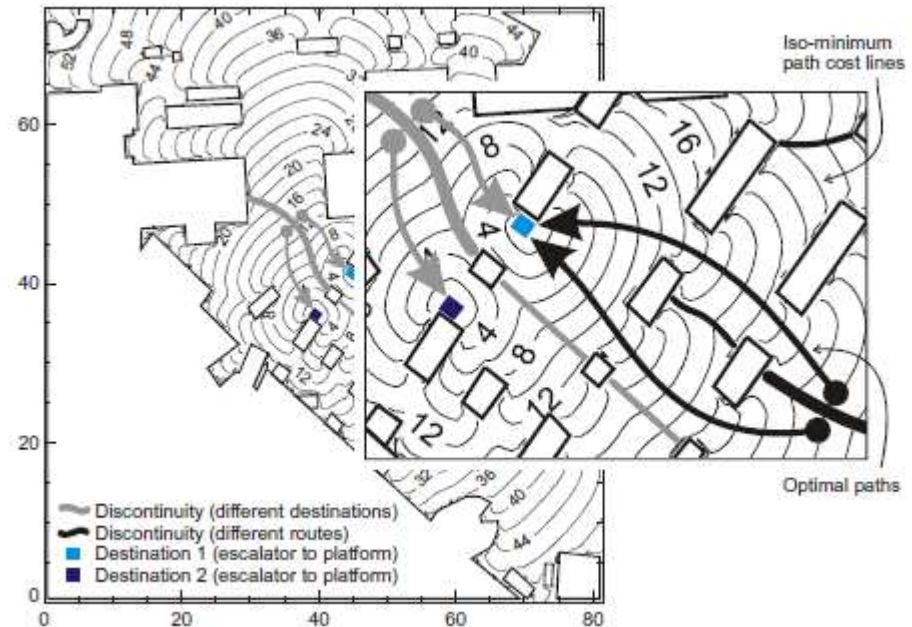

# Dynamique de piétons

- Le modèle de Hugues (continu):
  - Dynamique débit / densité
  - Coût minimum jusqu'à la destination
  - Coût déplacement local

$$\partial_t \rho + \operatorname{div} f = 0$$

$$f = \rho v$$

$$v = U(\rho, x)$$

$$C(v, x) \frac{f}{|f|} + \nabla \Phi = 0$$

# Modèle de Hugues (suite)

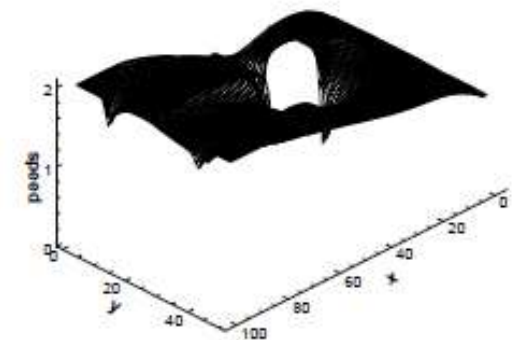
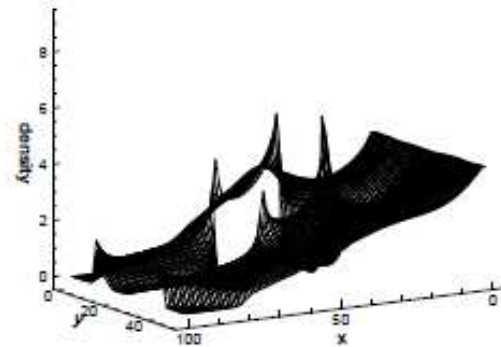
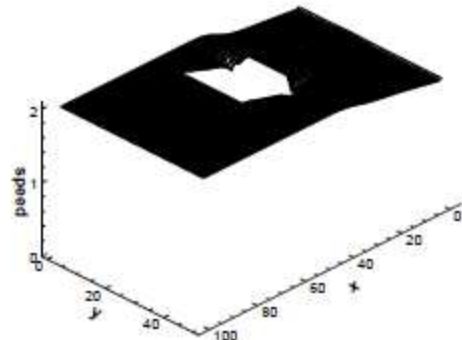
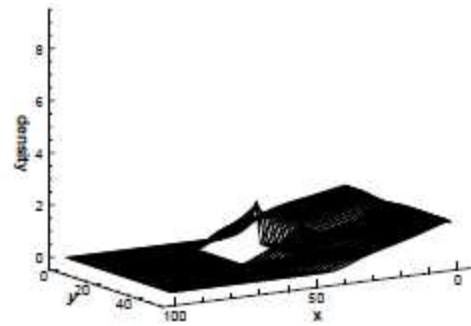
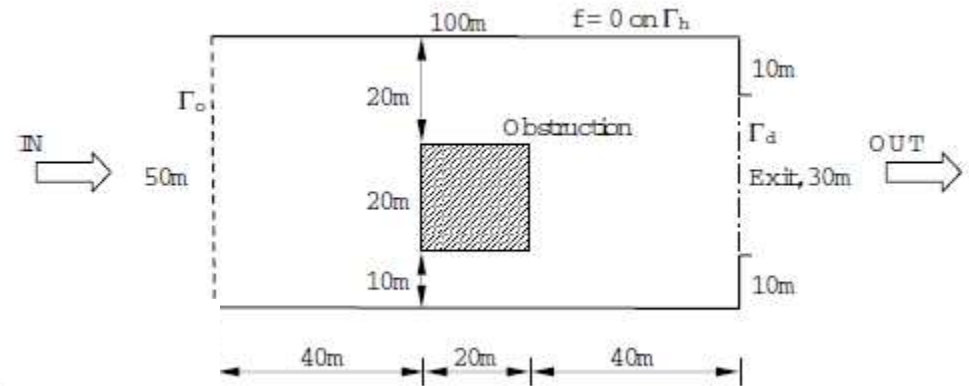

(Huang et al 2006)

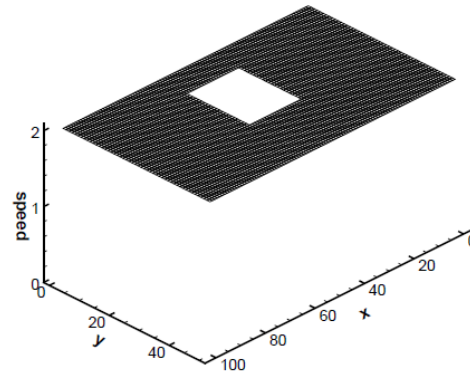
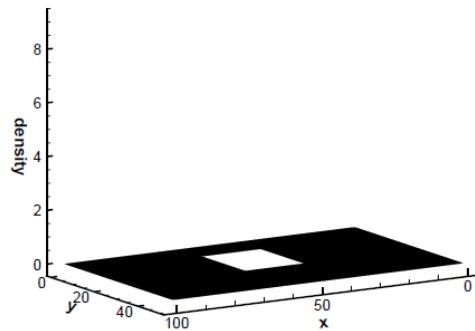
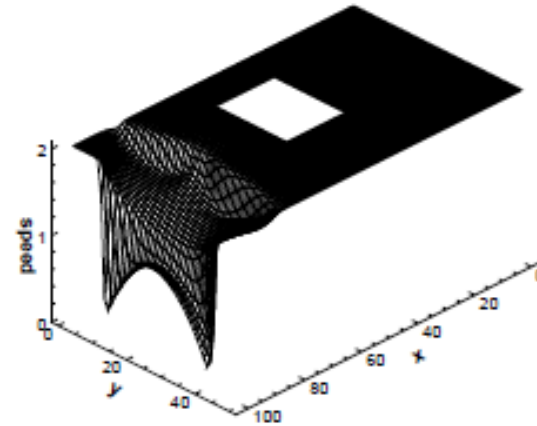
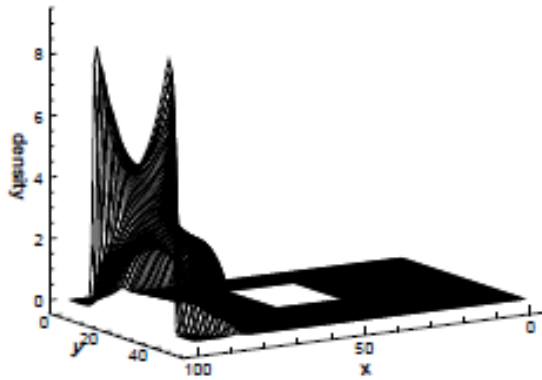
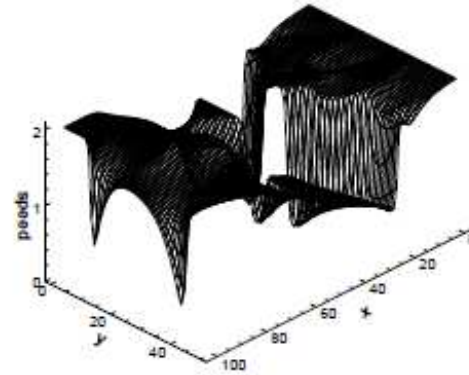
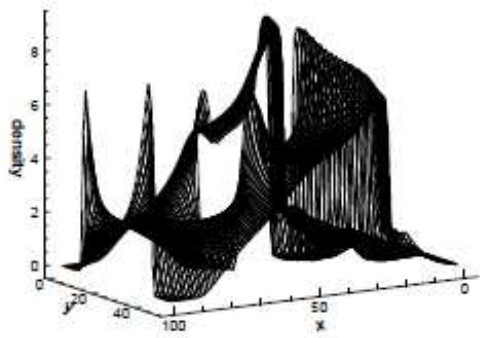
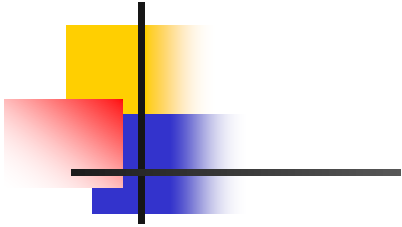



# Equilibre

$$\text{Min} \sum_a \int_0^{d_a} C_a(u) du$$

$$d_a = \sum_{p \ni a} f_p$$

$$T_w = \sum_{p \in w} f_p$$

$$f_p \geq 0$$

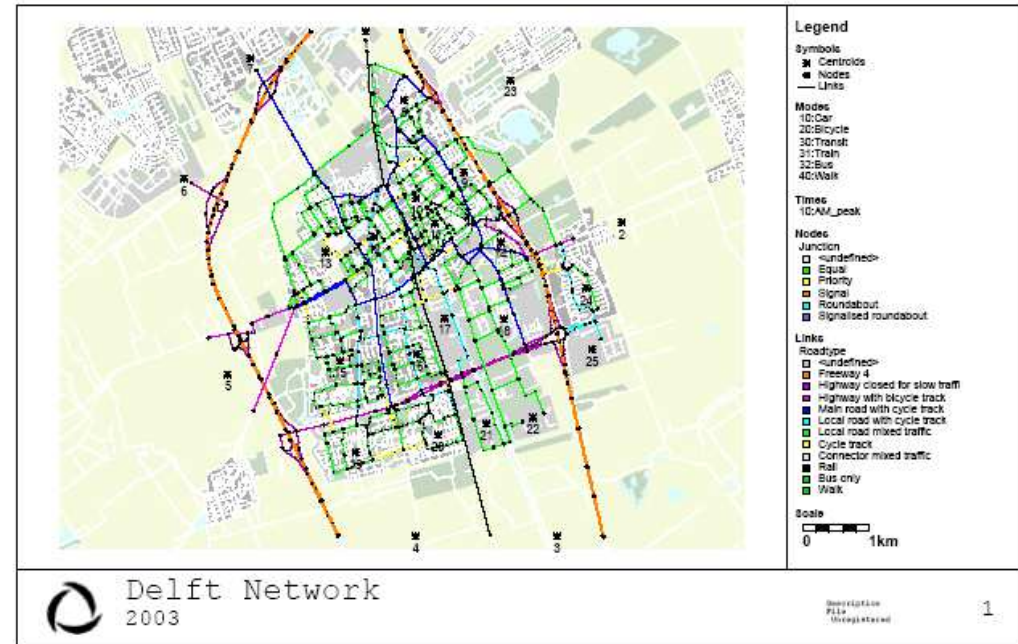

## ■ Equilibre:

- Plus un itinéraire est attractif, plus il est utilisé
- Plus un itinéraire est utilisé, plus son coût est élevé et moins il est attractif
- Equilibre ← principe d'optimalité (critère = coût de formation de l'équilibre)



# Evolution du modèle statique

- Multi-modes multi-classes:
  - Les coûts deviennent fonctions des débits modaux qui interagissent
  - Equilibre: point fixe (ou Inéquation variationnelle) Nagurney et al (198..)
- Fiabilité des réseaux (nicholson et al 2003, Karauchi et al 2009)
  - Vulnérabilité (arcs)

# Internal state node model

- The extension of the node is neglected (point wise intersection)
- The node is assumed to exhibit a global behavior: global supply and demand
- The demand is modified to take into account bounded acceleration
- Node  $\Leftrightarrow$  "buffer" between upstream and downstream link Boundary Conditions

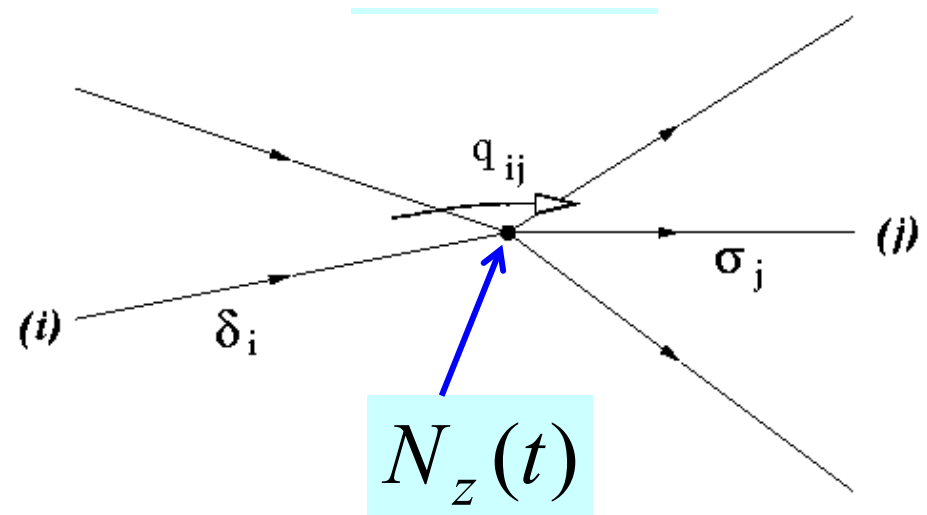

# Internal state model (simplified): basic variables

- Simplified case: merges.
- Descriptive variable: total number of vehicles
- Total demand, total supply, which are a function of total number of vehicles inside the node
- Demand: modified for bounded acceleration

$$N_z(t)$$

$$\Delta_z(N(t)), \Sigma_z(N(t))$$

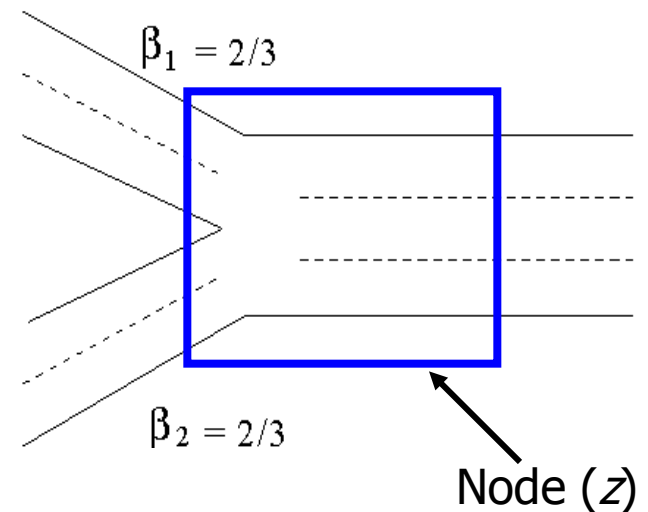

# Node supply, demand

- Main parameters

$Q_{z,x}$  : through - flow capacity

$N_{z,x}$  : storage capacity

$N_{z,c}$  : critical number of vhs

Node demand

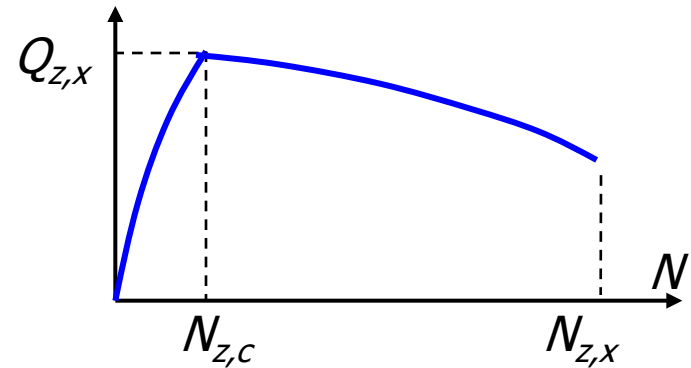

Node supply

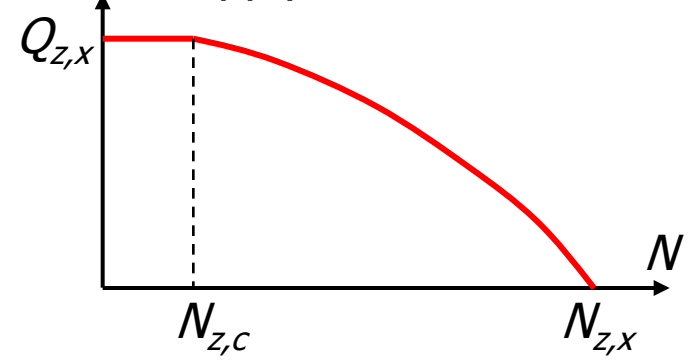

- For merges: the parameters are directly related to number of lanes, capacity

# Internal state node model

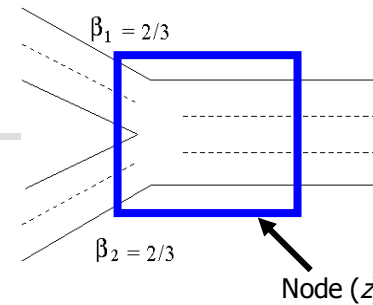
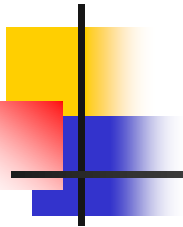

- The node supply is split (constant split coefficient)

$$\Sigma_{z,i}(t) = \beta_i \Sigma_z(N(t))$$

- Flows = Min(demand, supply)

$$q_i(t) = \text{Min}[\delta_i(t), \Sigma_{z,i}(N(t))]$$

$$p(t) = \text{Min}[\Delta_z(N(t)), \sigma(t)]$$

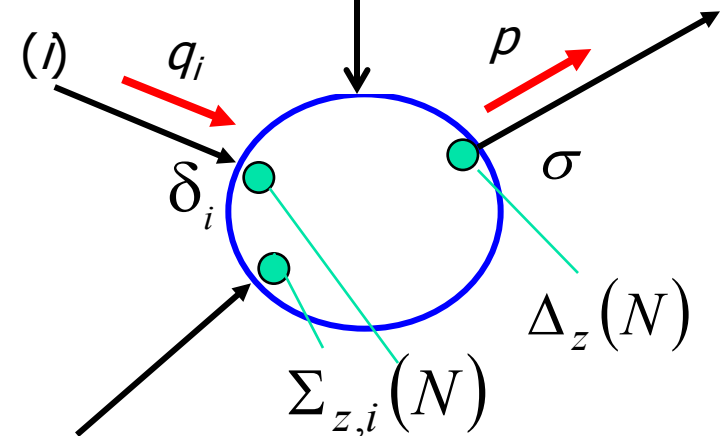
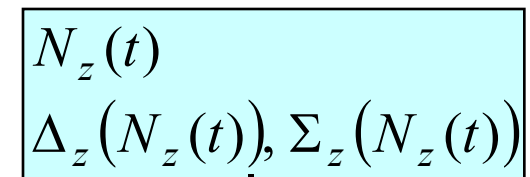

# Internal state node model: node state dynamics

- Min formula for the flows: **the invariance principle is satisfied**
- That is to say: LWR waves travel in the right directions
- Conservation equation for the numbers of vehicles stored inside the node (to be viewed as a finite volume element)

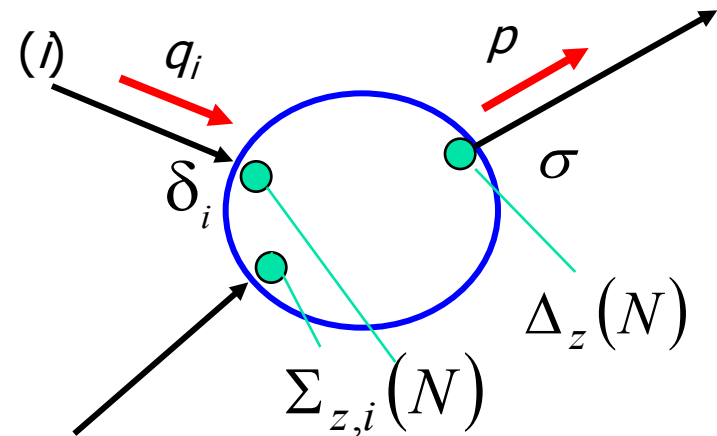

$$q_i(t) = \text{Min}[\delta_i(t), \Sigma_{z,i}(N_z(t))] = \text{Min}[\delta_i(t), \beta_i \Sigma_z(N_z(t))]$$

$$p(t) = \text{Min}[\Delta_z(N_z(t)), \sigma(t)]$$

$$\frac{dN_z(t)}{dt} = -p(t) + \sum_i q_i(t)$$

# A simple example: lane drop

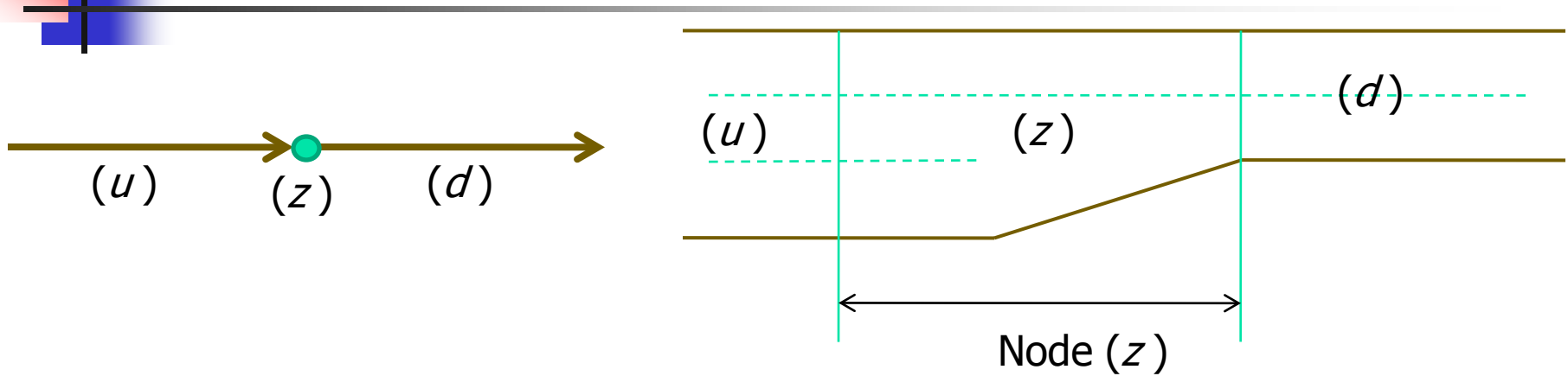
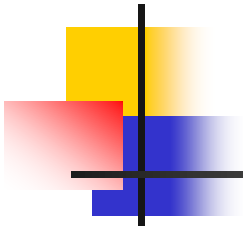

Node supply

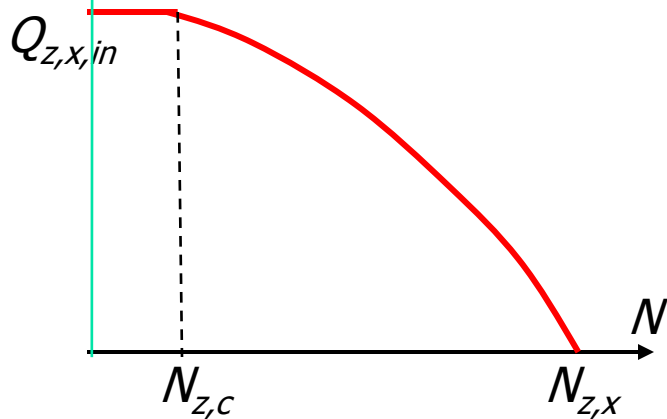

Node demand

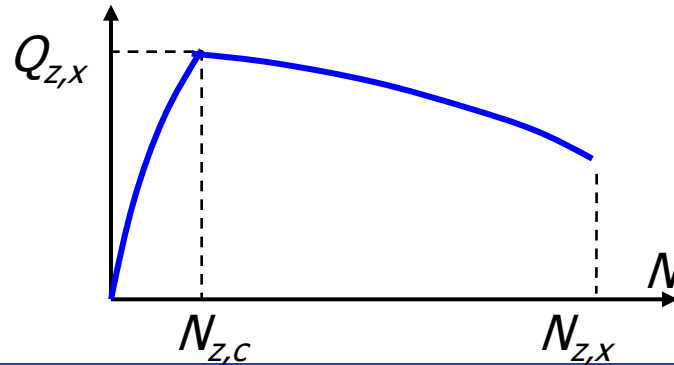

# Lane drop (2)

$$qI(t) = \text{Min}[\delta(t), \Sigma_z(N_z(t))]$$

$$qO(t) = \text{Min}[\Delta_z(N_z(t)), \sigma(t)]$$

$$\frac{dN_z(t)}{dt} = -qO(t) + qI(t)$$

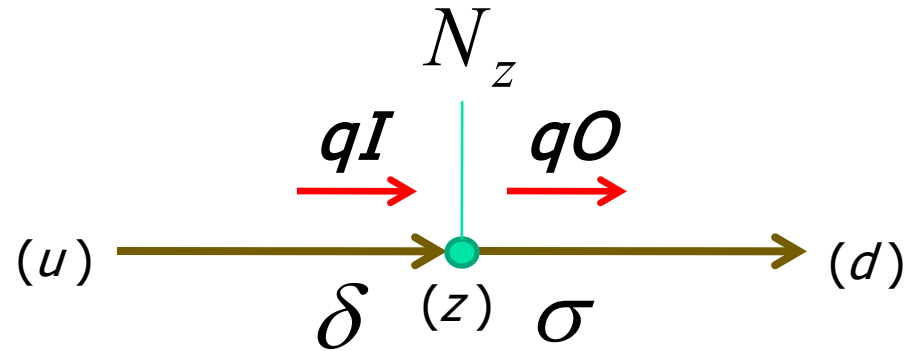

- The inflow is a decreasing function of the number of vehicles in the node
- The outflow is also a decreasing function of the number of vehicles in the node in congested traffic state
- $\rightarrow$  induces traffic hysteresis and capacity drop



# Lane drop (3)

- Assumption:
  - downstream supply = capacity,
  - node outflow = demand
  
- Equilibrium, at a level below the capacity of the node (and of the downstream infrastructure)
  
- Stable equilibrium:
  - If  $N > N^*$ , the outflow is greater than the inflow,  $N$  decreases
  - If  $N < N^*$ , the outflow is less than the inflow,  $N$  increases

$$qI(t) = \text{Min}[\delta(t), \Sigma_z(N_z(t))]$$

$$qO(t) = \text{Min}[\Delta_z(N_z(t)), \sigma(t)]$$

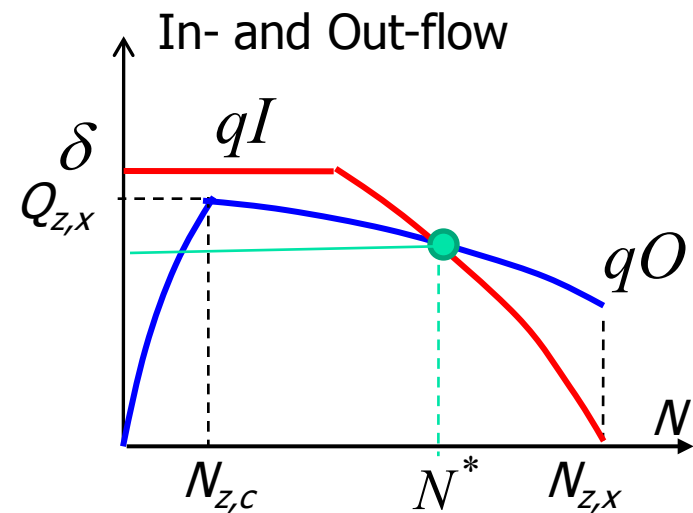

# Other possible equilibrium configurations

- Upstream demand high, but less than downstream capacity:
  - 3 equilibria, 2 stable:  $N^{*1}$   $N^{*3}$ , and 1 unstable  $N^{*2}$
  
- Upstream demand high (previous slide): 1 equilibrium left:  $N^{*3}$
  
- Upstream demand low: 1 equilibrium left:  $N^{*1}$

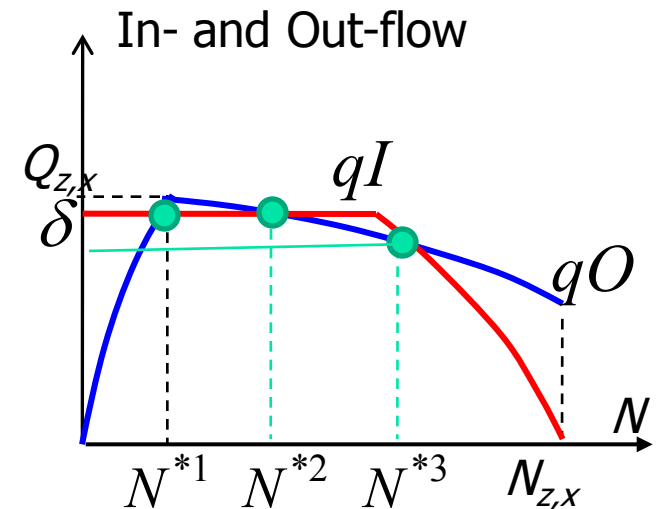

# Hysteresis

---

- Consider a cycle where the upstream demand
  - starts low
  - Increases above the downstream capacity
  - Decreases below the flow level of the equilibrium point  $N^*$

# Hysteresis (1)

■ X

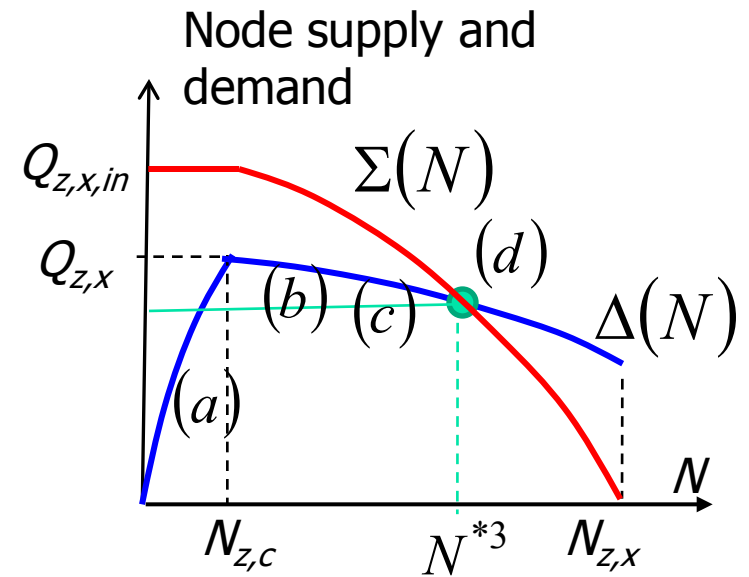
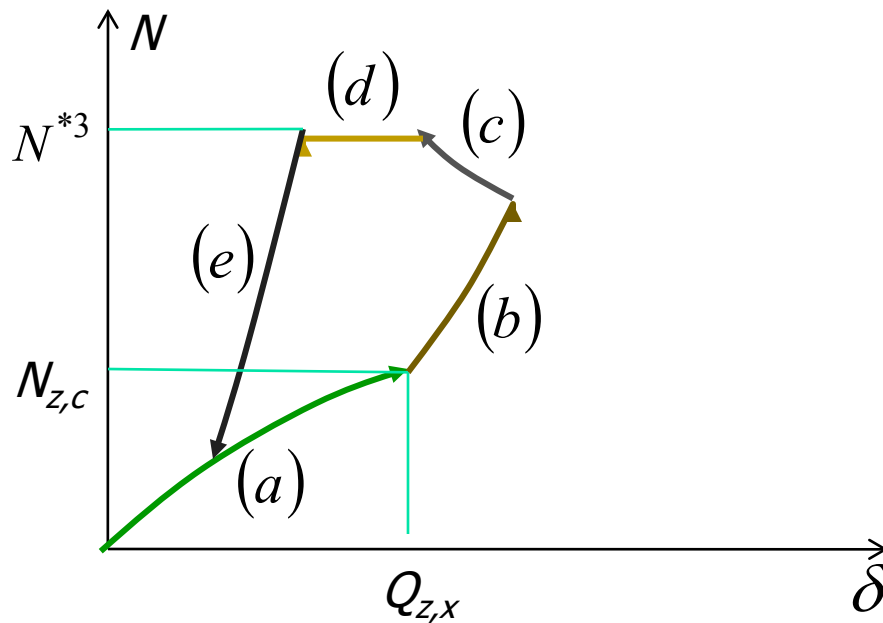

# Comparison: data vs model (LWR + Bounded acceleration node) Flow downstream of the merge

■ X

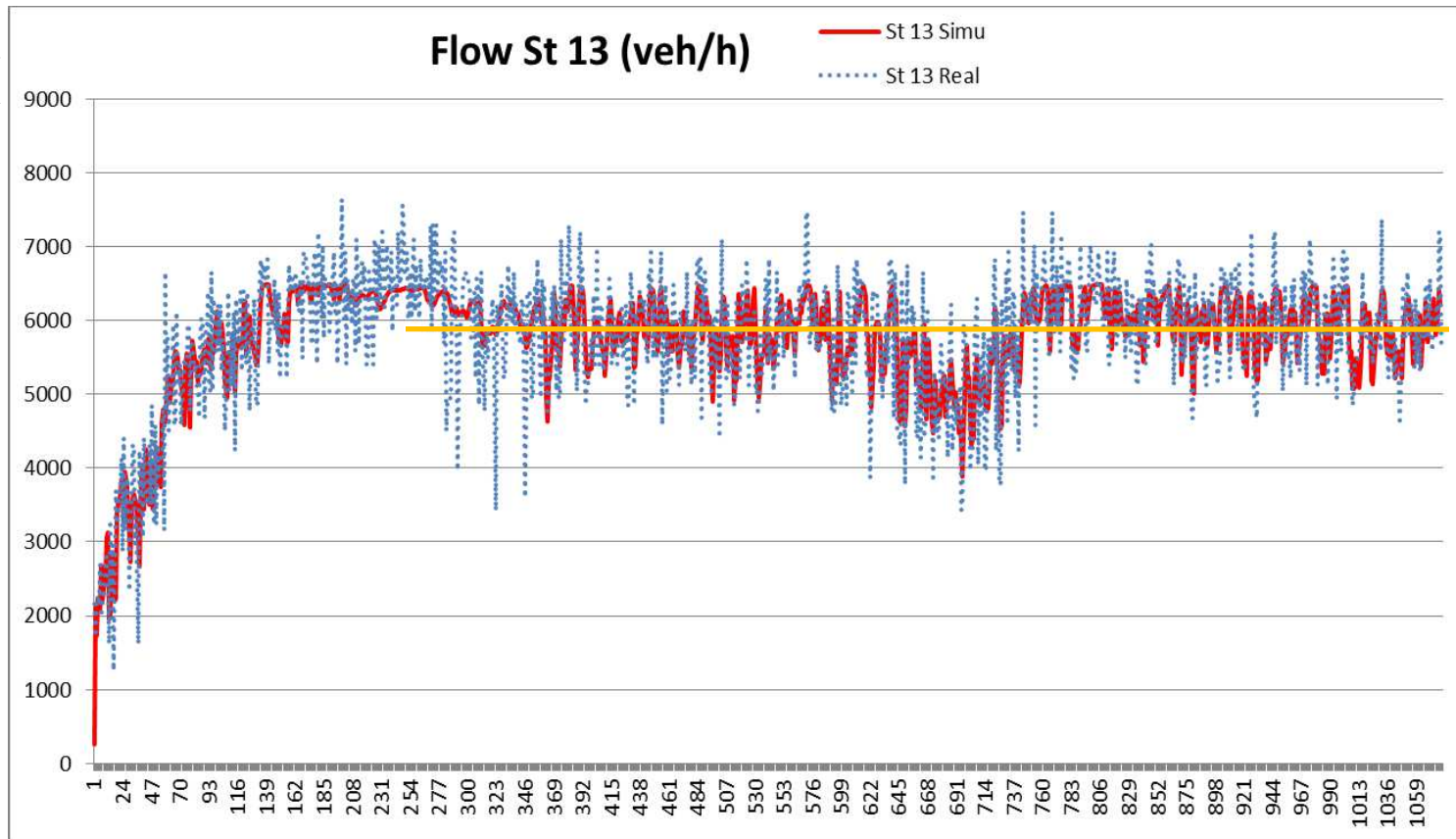



# Streaming data

---

- Usually abundant but incomplete and biased
- Model required for completion
  - Ex: add bidimensional model of area to a model of links with data
  - Ex: estimate traffic light requires additional traffic model (fi LWR)

# L'équation d'Hamilton-Jacobi résulte du principe d'optimalité

- Une trajectoire optimale jusqu'à  $T$  résulte d'une trajectoire optimale jusqu'à  $T - dT$  et d'un incrément  $L$

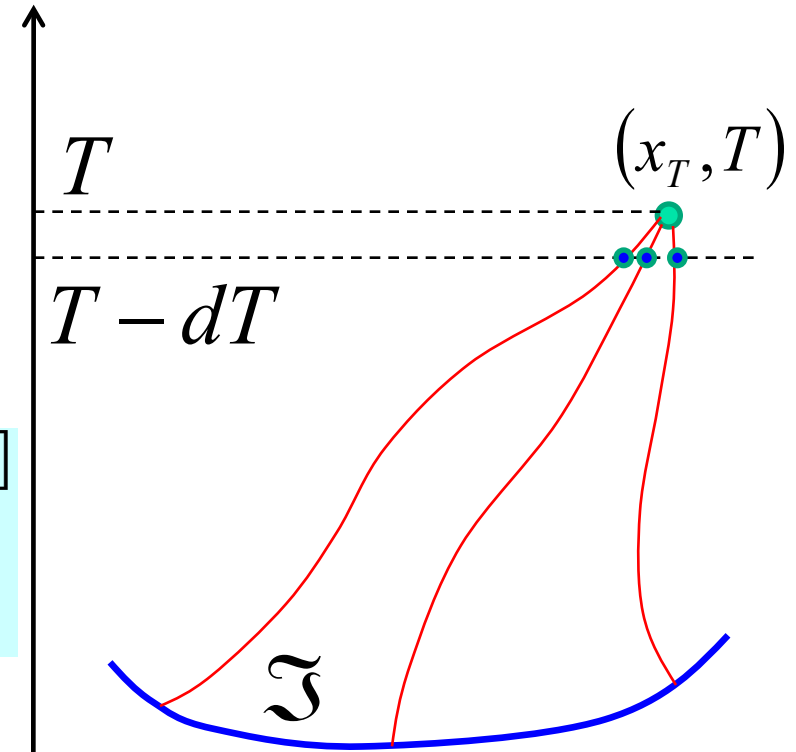

$$J(x_T, T) = \text{Min}_u [J(x_T - dx_T, T - dT) + L(x_T, u, T)dT]$$

$$\left| \begin{array}{l} u \in \mathfrak{R}(\rho(x_T, T)) \\ dx_T = u dT \end{array} \right.$$

# Taxi data (pb: representativity. Ex Mobile millenium)

A Hofleitner

- Partial view
- In IdF: main link for taxis = Paris → Roissy
- Necessary to complete with models! (**general comment**)

