



HAL
open science

Quantitative DEM of dense granular packings with a multiple contacts force model

Nicolas Brodu, Joshua Dijksman, Robert Behringer

► **To cite this version:**

Nicolas Brodu, Joshua Dijksman, Robert Behringer. Quantitative DEM of dense granular packings with a multiple contacts force model. MGMAS 2014 - Modeling Granular Media Across Scales, Jul 2014, Montpellier, France. hal-01024663

HAL Id: hal-01024663

<https://inria.hal.science/hal-01024663>

Submitted on 16 Jul 2014

HAL is a multi-disciplinary open access archive for the deposit and dissemination of scientific research documents, whether they are published or not. The documents may come from teaching and research institutions in France or abroad, or from public or private research centers.

L'archive ouverte pluridisciplinaire **HAL**, est destinée au dépôt et à la diffusion de documents scientifiques de niveau recherche, publiés ou non, émanant des établissements d'enseignement et de recherche français ou étrangers, des laboratoires publics ou privés.

Quantitative DEM of dense granular packings with a multiple contacts force model

Nicolas Brodu^{1,2}, Joshua Dijksman^{1,3}, Robert Behringer¹

¹ Department of Physics, Duke University, USA

² Geostat team, INRIA Bordeaux, France

³ Wageningen University, Wageningen, The Netherlands

Modeling Granular Media across scales, Montpellier, July 2014

MOTIVATION

1. 3D Experiments

Access to the micro-structure, 3D force vectors

Used as a reference for a comparison with DEM

2. DEM

Usual DEM + Hertz interactions not good enough

Interactions between multiple contacts

ACCESSING THE MICRO-STRUCTURE

X-rays / micro-ct

Fine resolution

Most materials

Costly

Confocal: emulsions

Microscopic

Costly

Difficult to control applied stresses

This work: refractive index matching

Macroscopic grains

Easy to control, tri-axial shearing

Cheap

Submersed

Next slides on:

1. Structure
2. Forces in 3D

Mukhopadhyay *et al.*
Phys. Rev. E 84, 011302, 2011

Dijksman *et al.*
Rev. Sci. Instrum. 2012

Hydrogel grains
index-matched
+ fluorescent dye

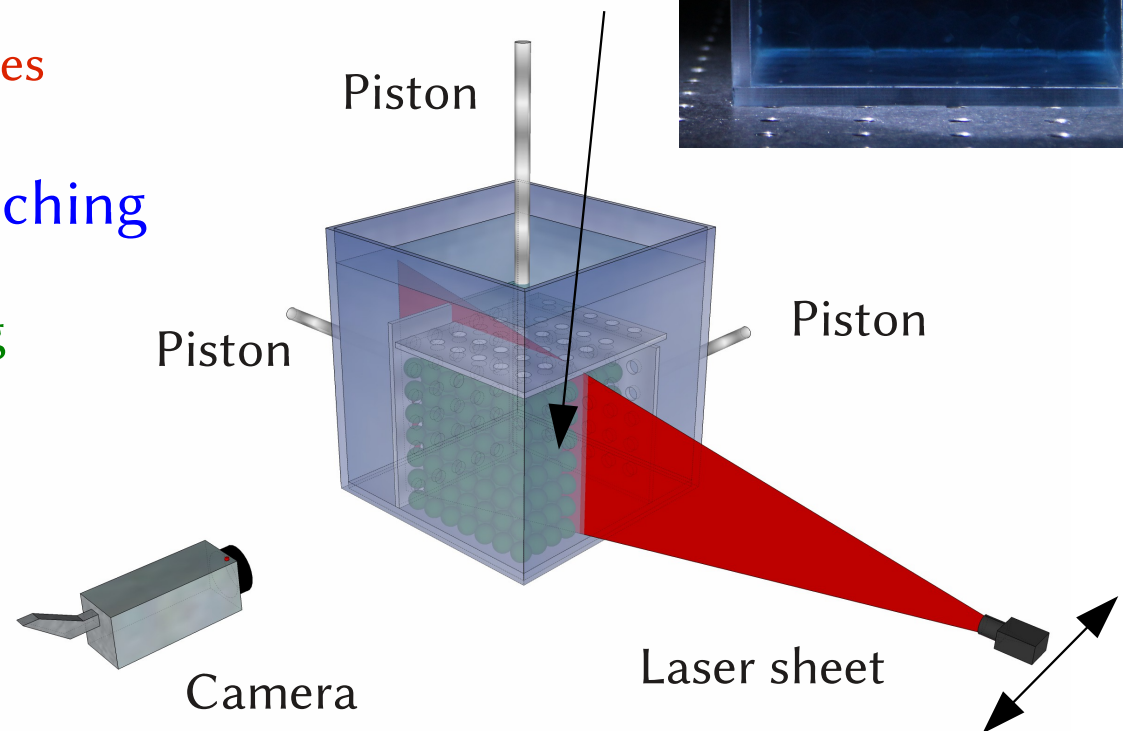
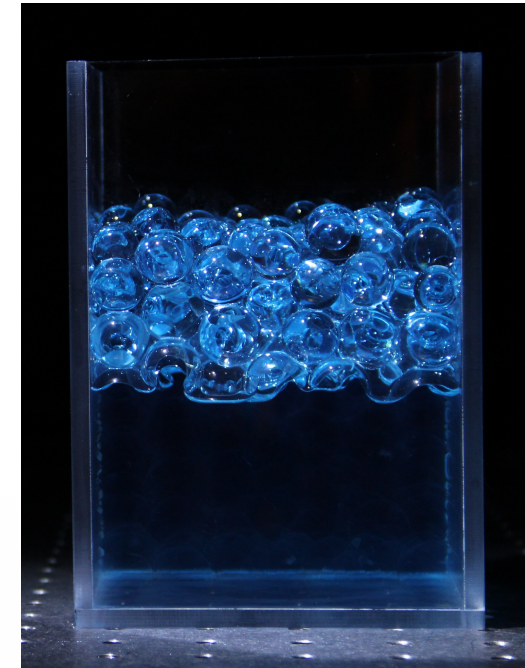

WHAT WE GET

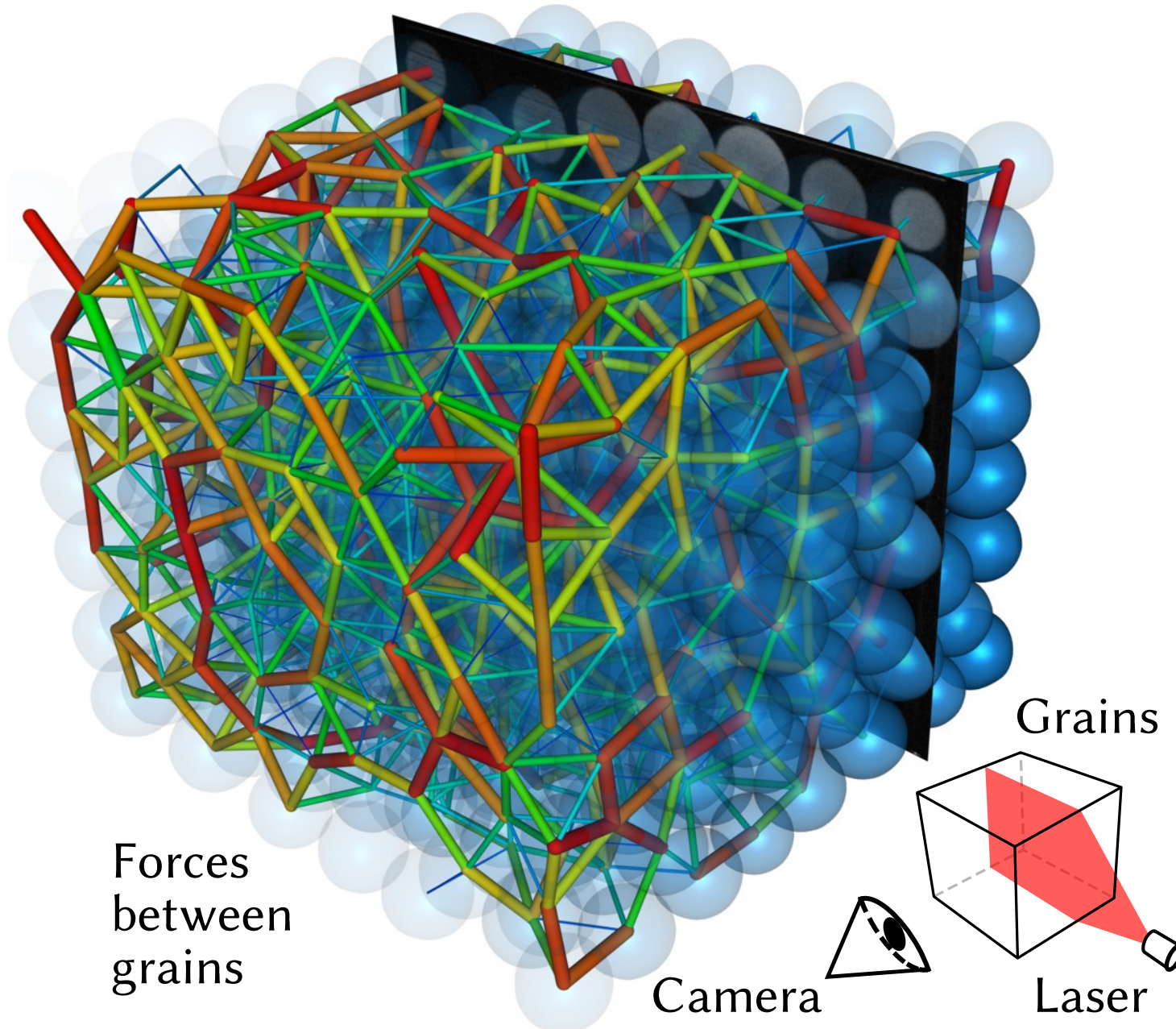

TYPICAL IMAGE

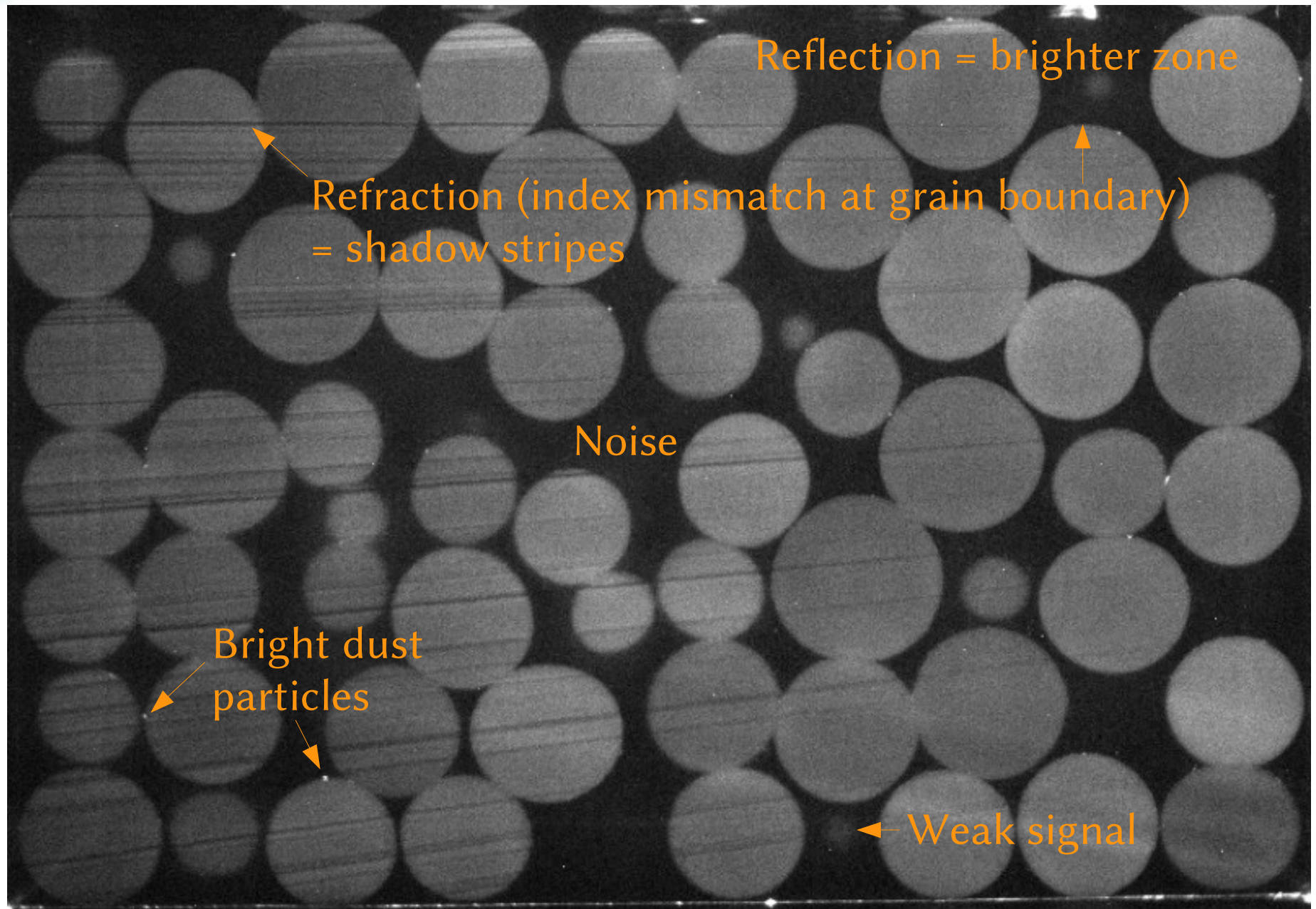

FROM 2D IMAGES TO 3D GRAINS

Step 1: Stack the images into 3D voxels

Step 2: Detect border voxels and assign them to unique grains

Step 3: Fit an analytic surface to these borders

Step 4: Use these surfaces to get accurate forces

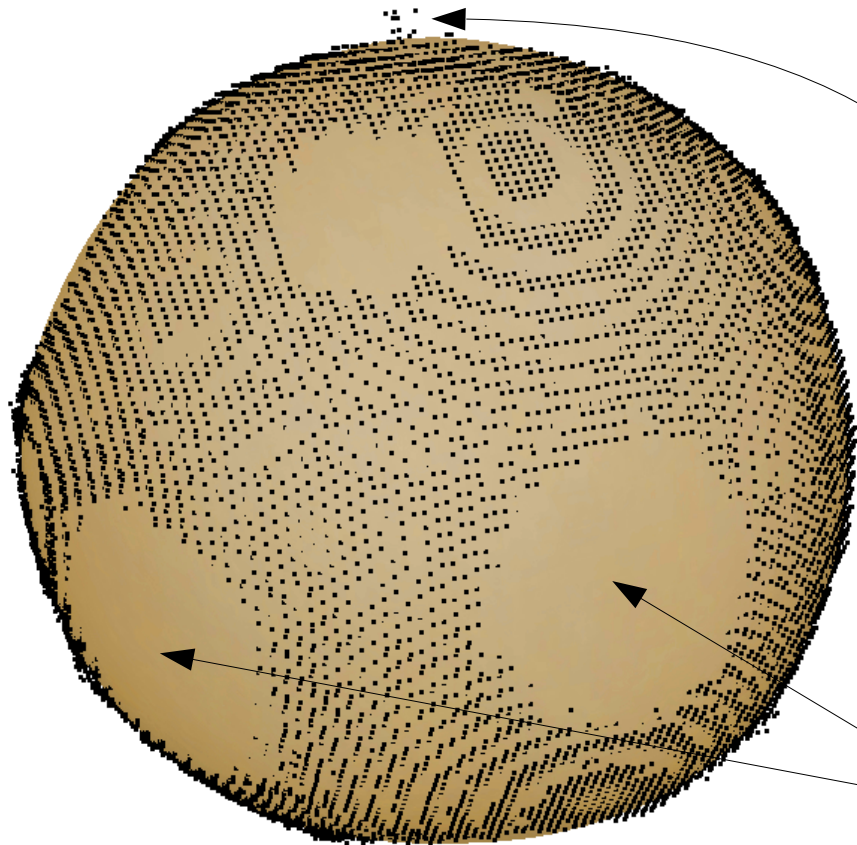

Outliers completely eliminated

Contacts = no border between grains
BUT surface area is well defined

INFERRING FORCES IN FULL 3D

Analytic shape descriptions \Rightarrow contact properties

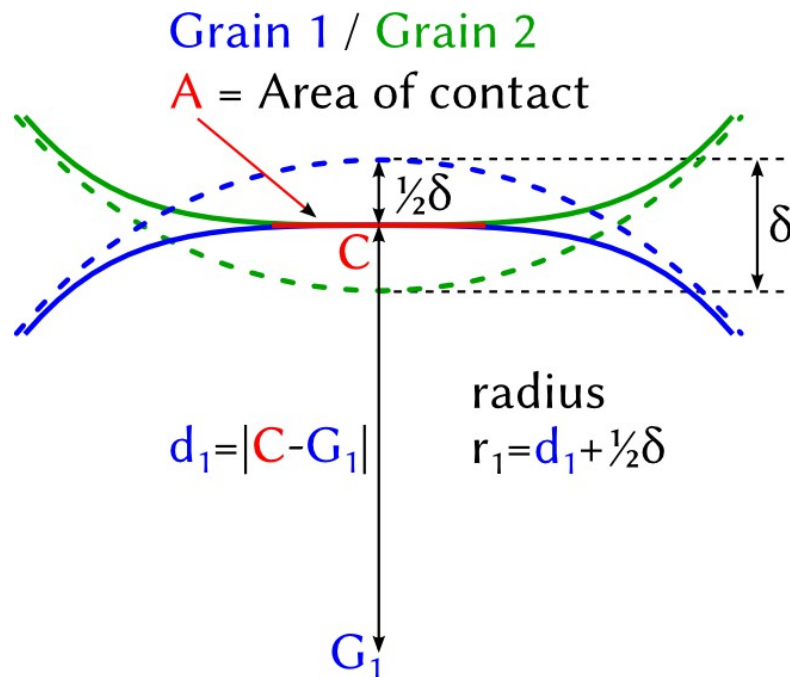

Measured here: A , C , G_1 , G_2 , d_1 , d_2 .

Unknown: δ

Contact properties \Rightarrow forces

$1/r = 1/r_1 + 1/r_2$ radius of curvature at contact

$F = E r^{1/2} \delta^{3/2}$ E = effective Young modulus

$F = E \delta a$ $a = \sqrt{A/\pi}$ radius of the contact

Hence $r \delta = A/\pi \Rightarrow \delta \Rightarrow F$ (with given E)

\Rightarrow Vector forces in full 3D, with orientation, position, norm
 + grain centers of mass, stress tensor, etc.

UNI-AXIAL COMPRESSION CYCLES

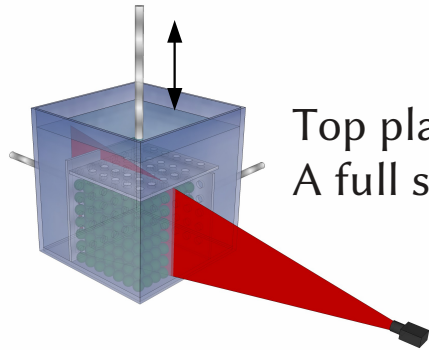
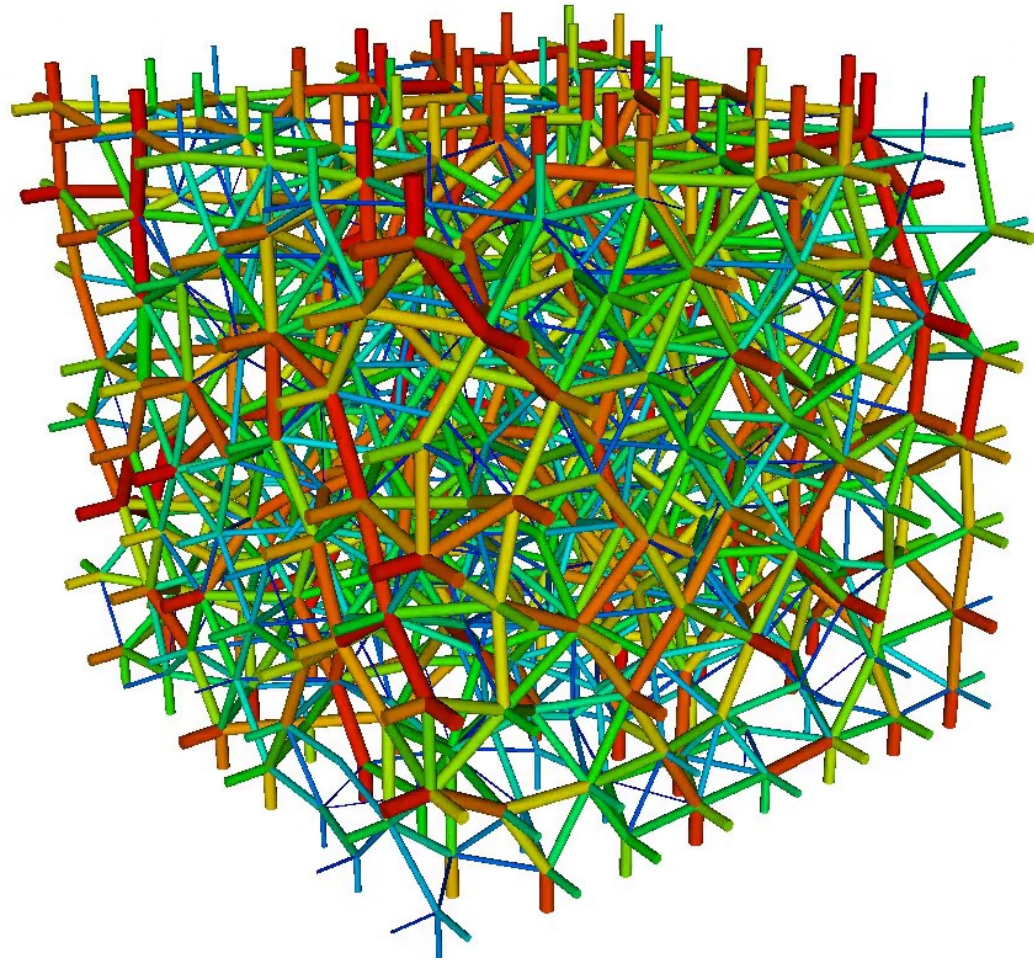
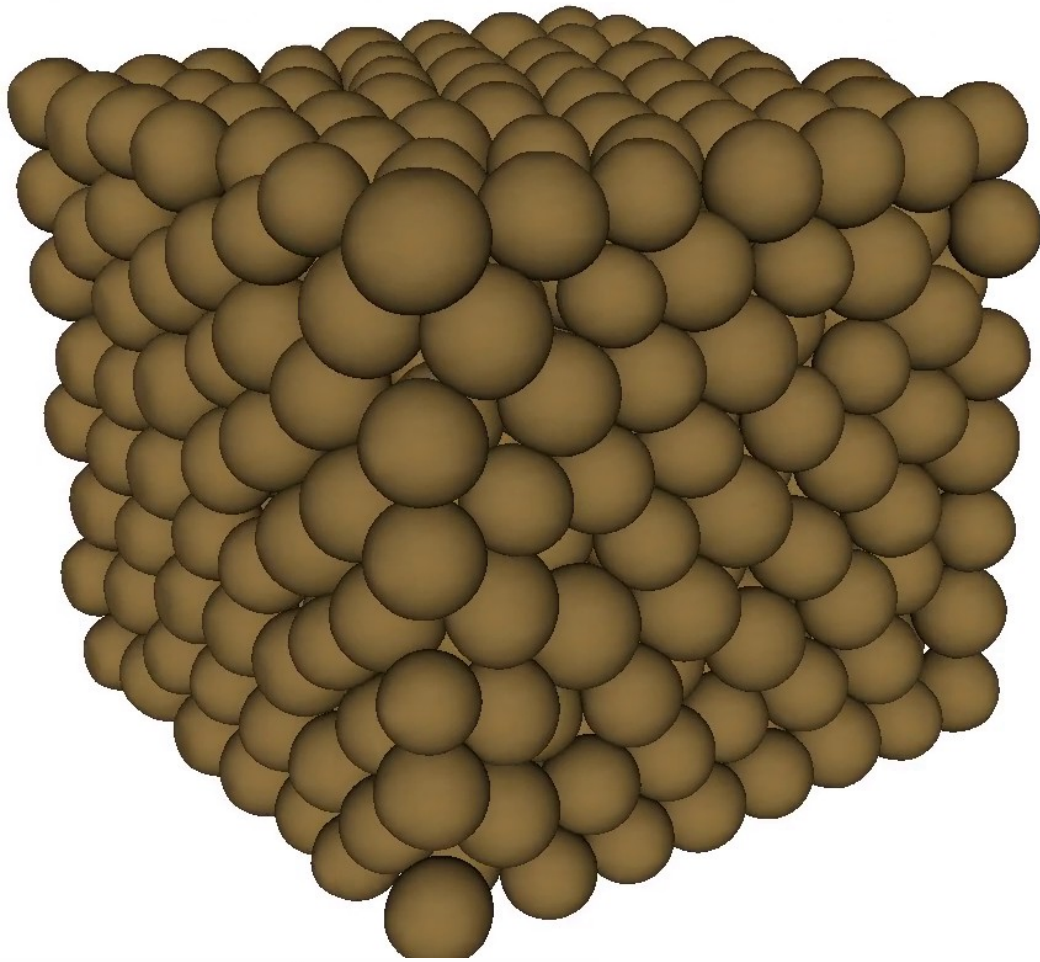

Top plate moves by 1mm increments
A full scan is taken between increments

Forces = struts joining the grain centers
Blue = weakest, Red = strongest

VALIDATION ON COMPRESSION CYCLES

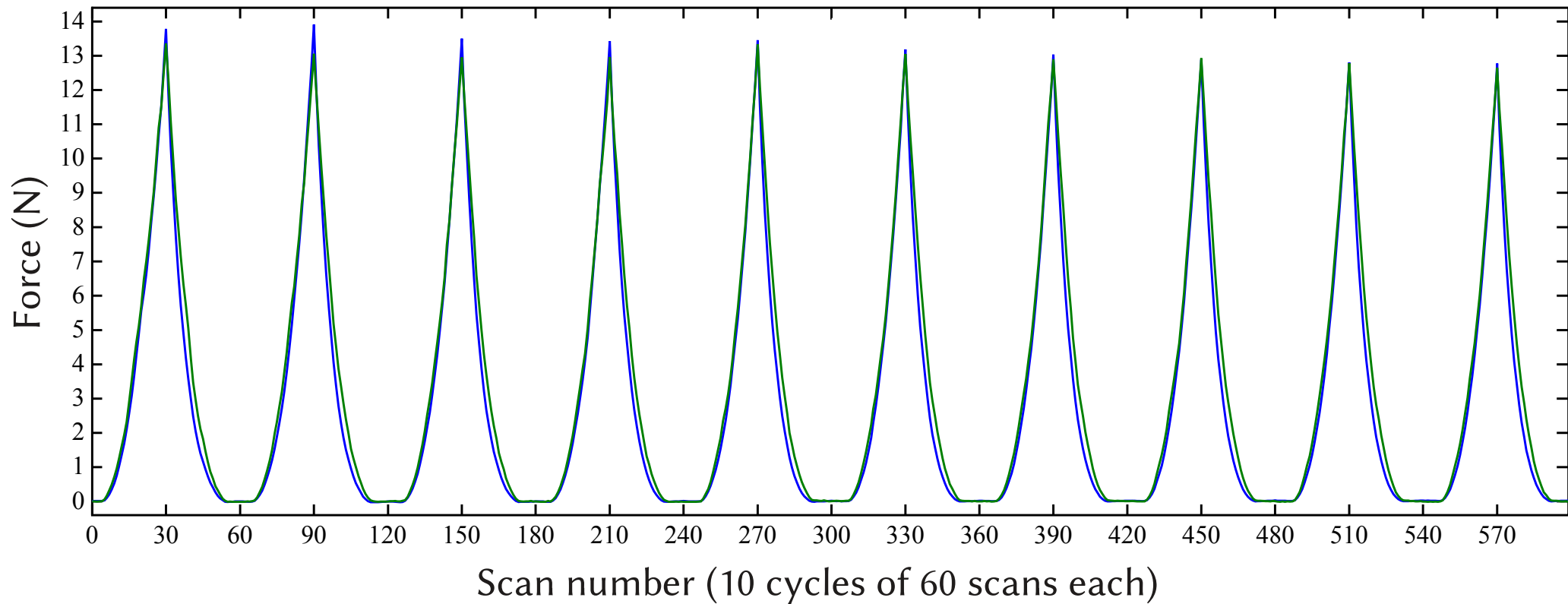

Blue = force measured on the top plate sensor

Green = force inferred from the images + measure of $E \approx 23$ kPa

Full experiment:

Maximal compression of $\Delta \approx 13\%$ the initial height

Average force at min compression $\approx 10^{-2}$ N

20 cycles = 1200 scans, >1M contacts (=good stats!).

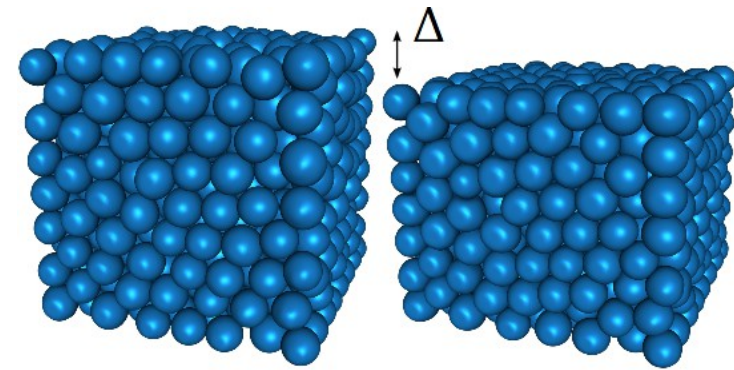

NON-HERTZIAN PACKING RESPONSE

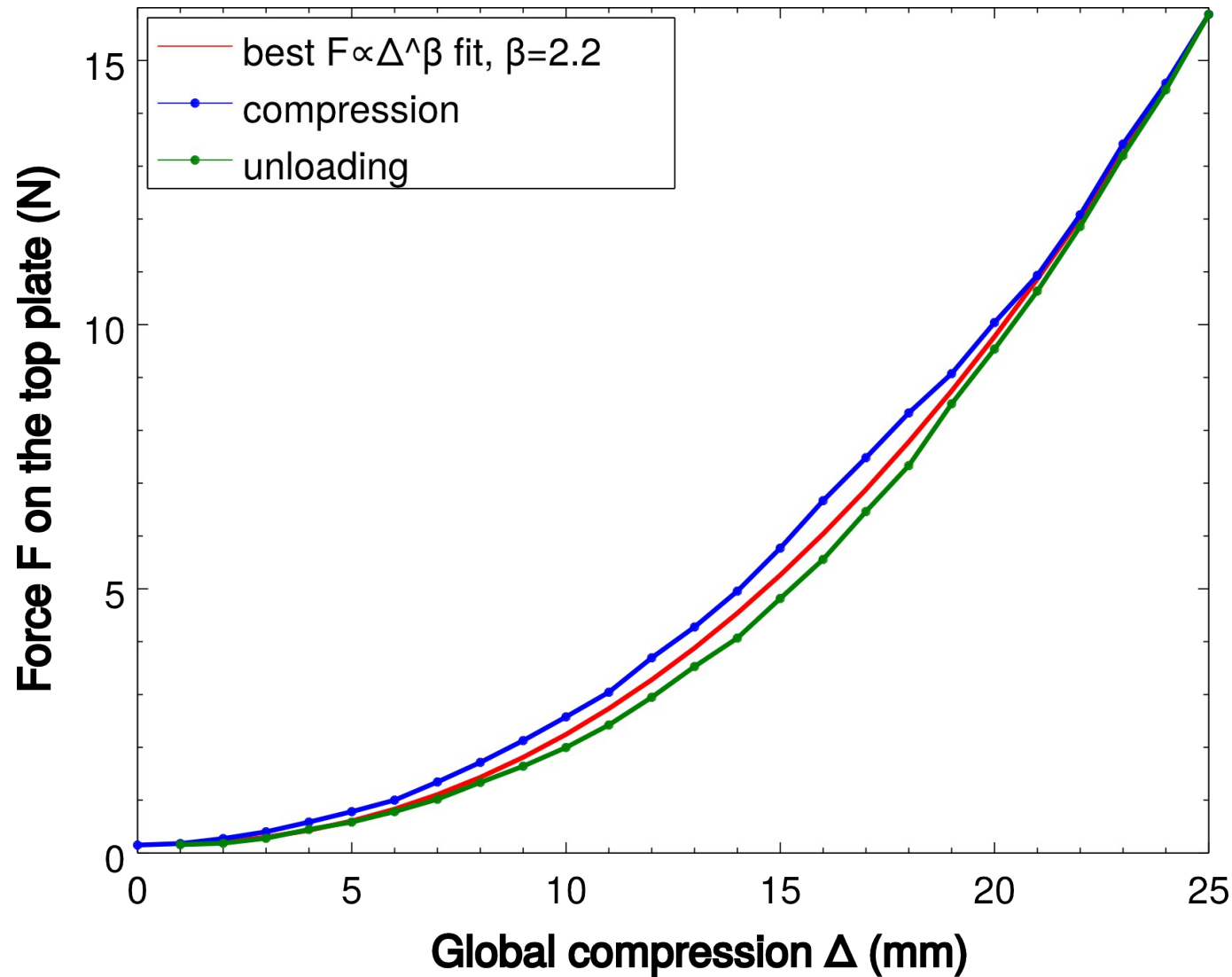

A SCALING HOLDS

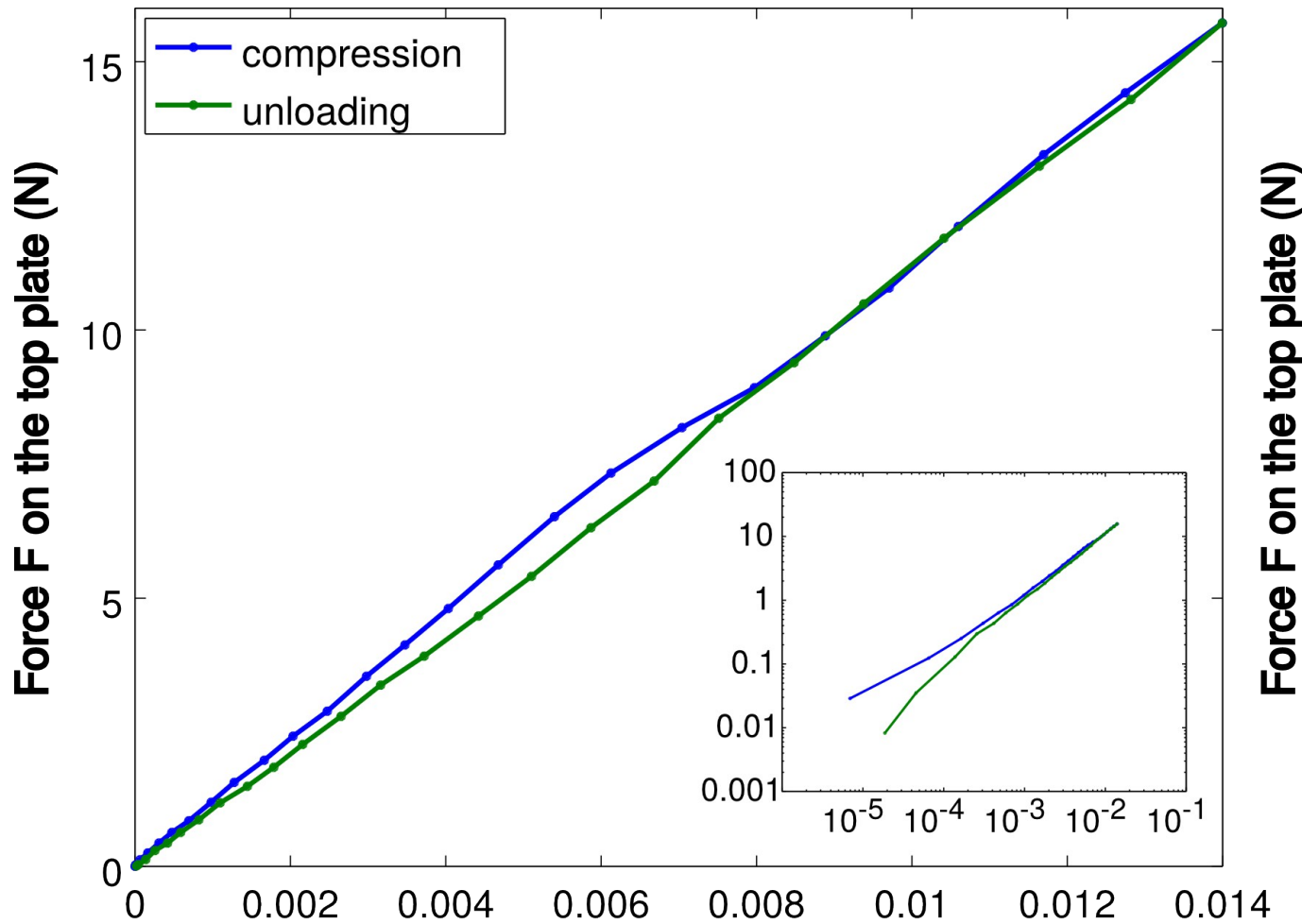

$$F \propto \Delta^\beta$$

$$\updownarrow$$

$$f \propto \delta^{3/2}$$

Links Micro & Macro
 $\Rightarrow \Delta(\delta)$ relation

Source of the scaling
 = stress tensor
 (details on demand)

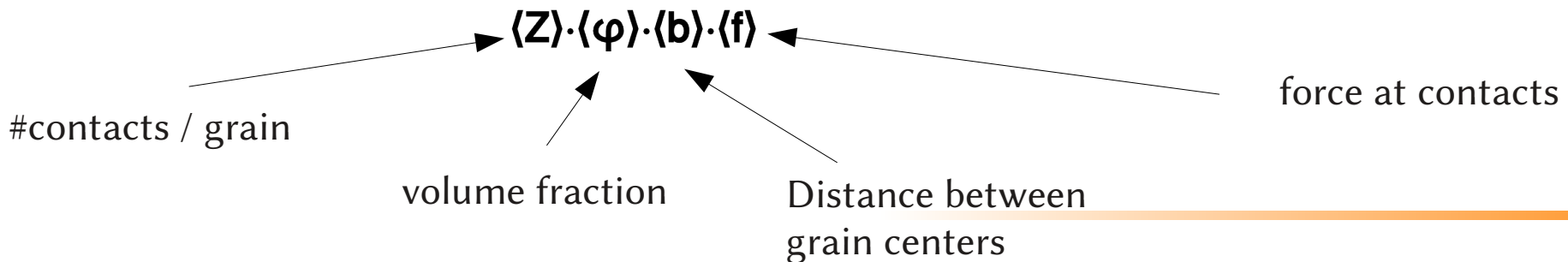

DEM OF THE “SAME” SYSTEM

Standard DEM simulation

- Overlapping non-deformable spheres, overlap = δ
- + Force model $F = F(\delta)$ (either linear, Hertz, hysteretic...)
- + Solid Dynamics (friction, solid bodies)
- + Newton's law for integrating the new positions after an elementary dt
- = Trajectories of all particles + all contact properties

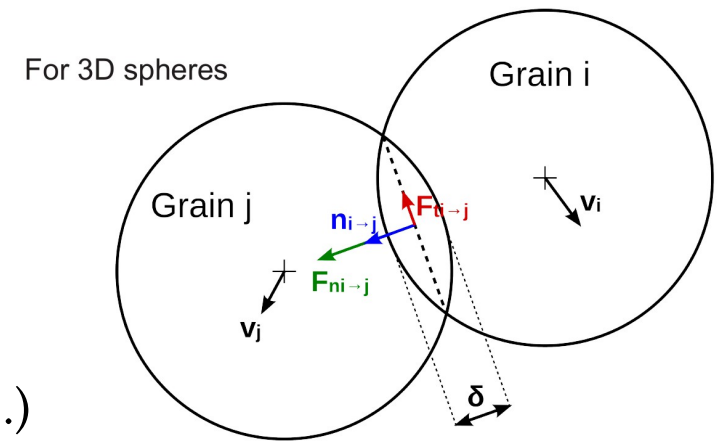

As close as we can get to the experimental setup

Hertz + same material properties

Grains are replaced by spheres of the same volume with the same center of mass

Same box size and piston motion

COMPARISON WITH DATA

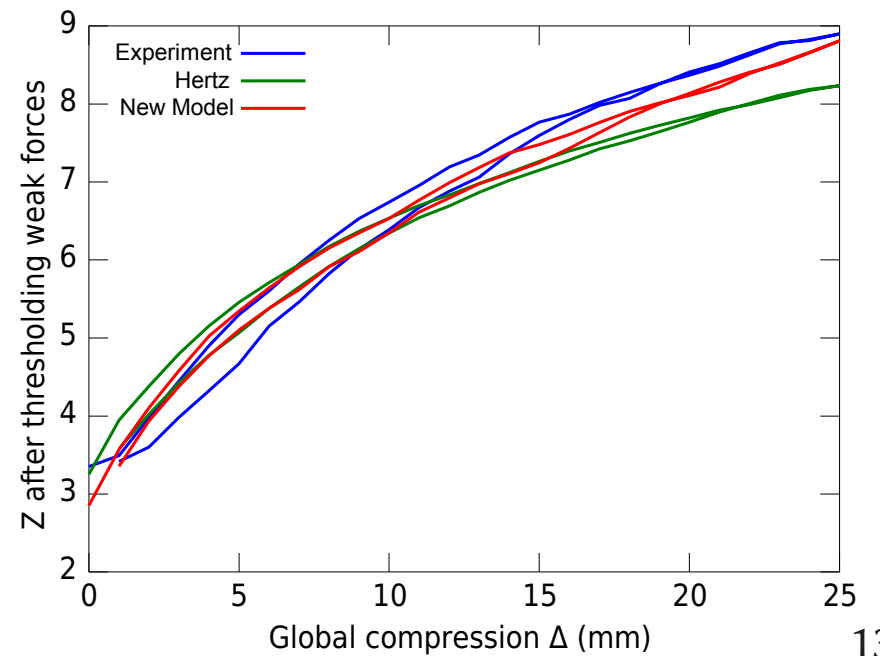
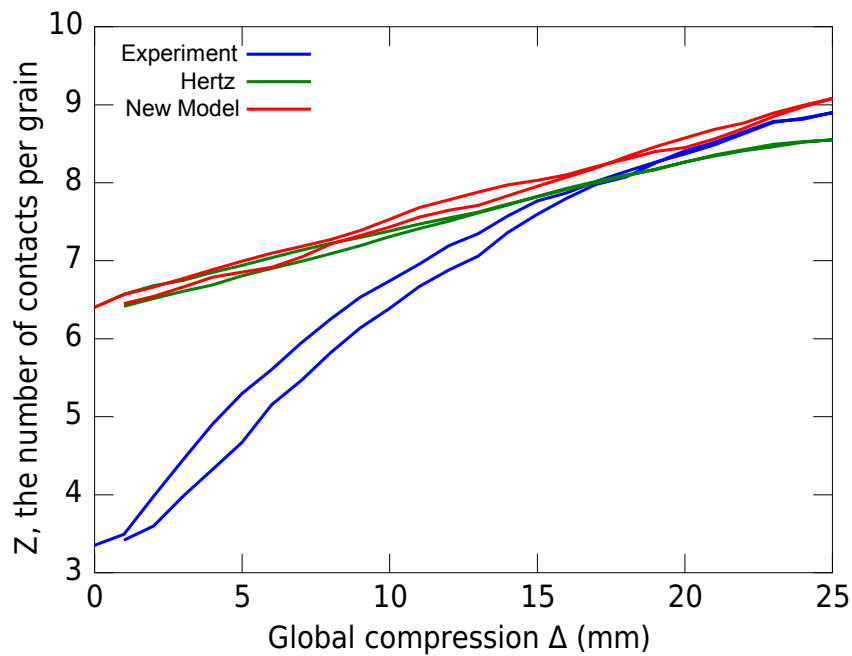
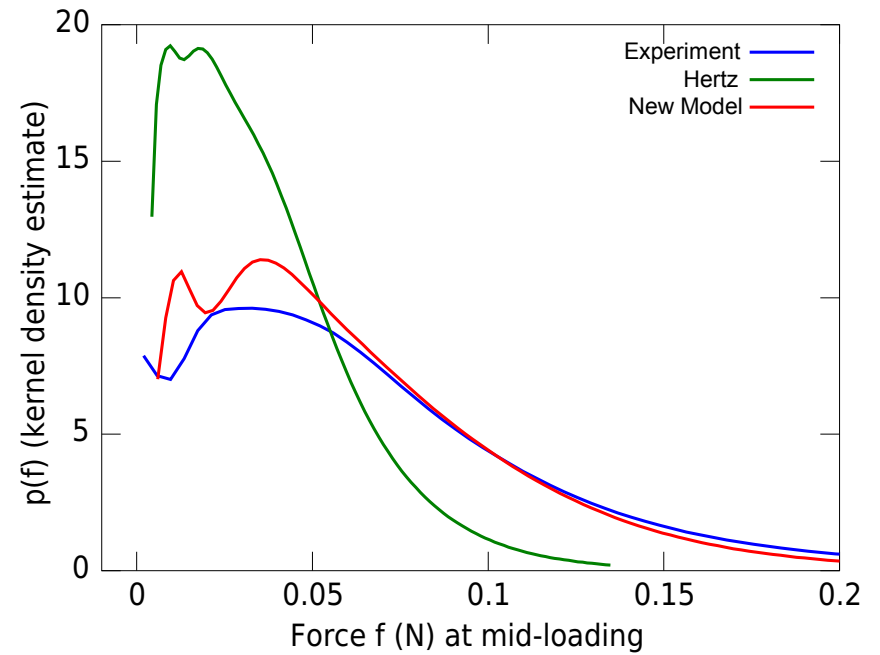
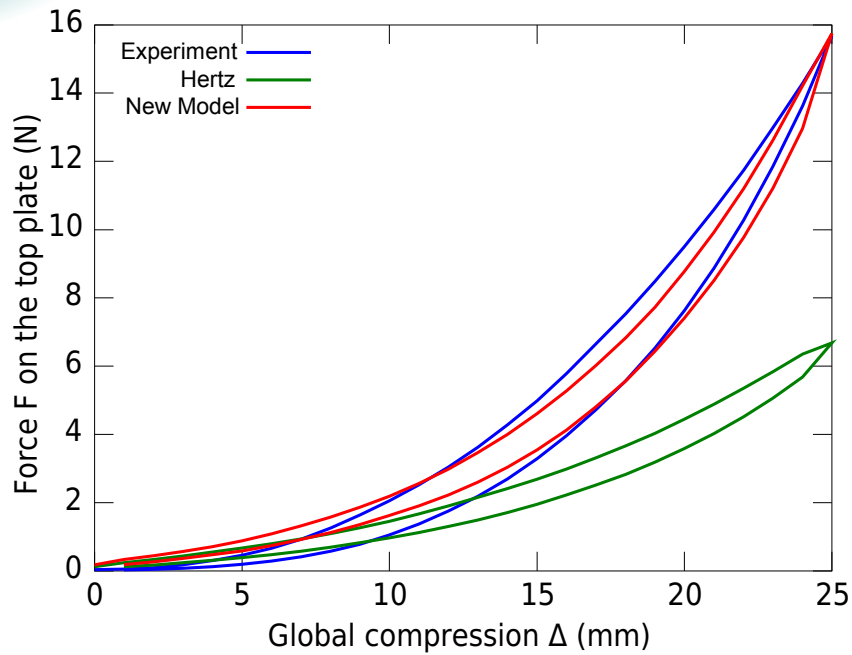

DEALING WITH MULTIPLE CONTACTS

Usual DEM model

- Non-deformable spheres
- Independent contacts $F_c = f(\delta_c)$

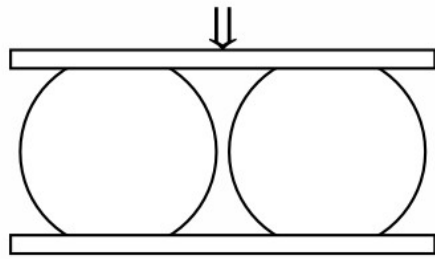

The new model

- Surface deformations can create new contacts
- Multiple contacts $F_c = f(\delta_c, \delta_i, \delta_j, \delta_k, \delta_l)$

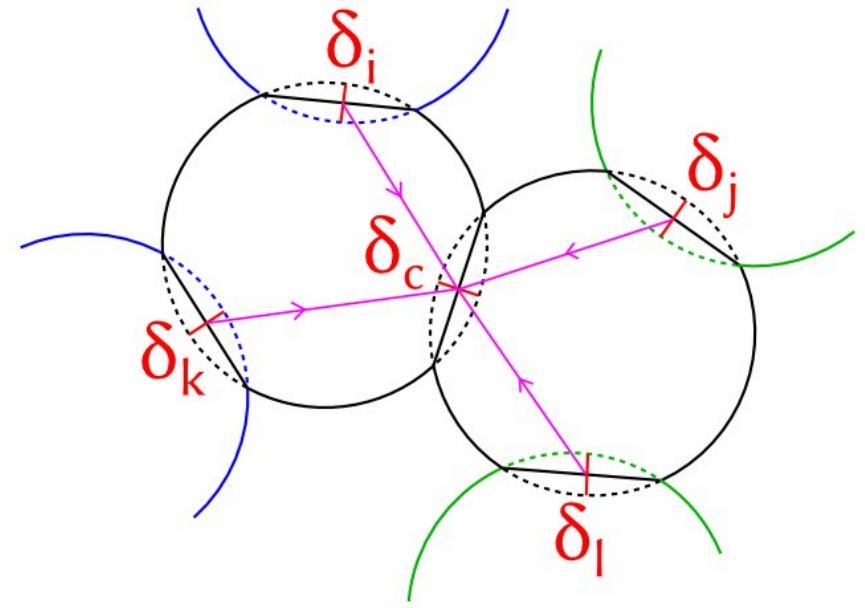
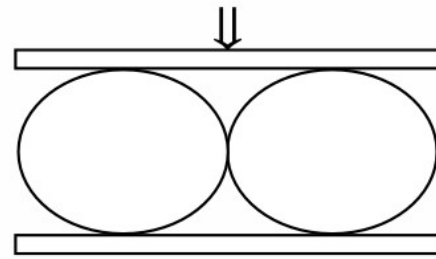

Correlation between contacts (ex [Gonzalez/Cuitiño])

- δ_c = the deformation at contact c .
- Other contacts i, j, k, l have an extra influence on c

New model

- A different expression for the correlations
- Surfaces are deformed **before** the grains touch: new contacts can be created
- **Backed up by data!**

INDUCED DISPLACEMENTS

Sphere-based ideas in the literature

- Point force on full sphere solution [Bondareva 1969]
- Gonzales / Cuitiño, approximating Zhapanska's solution for two spheres in contact

Problem:

Dense granular material is more like an interconnected medium with pores

Very complex boundary (+inner) conditions.

DEM \Rightarrow Decoupling of the grains. Contact model = recoupling.

Here: Linear Elasticity on infinite half space

- Point force applied on elastic material
- Half-plane approximation = consistent with Hertz
- Geometric factor introduced in the model to compensate for the holes

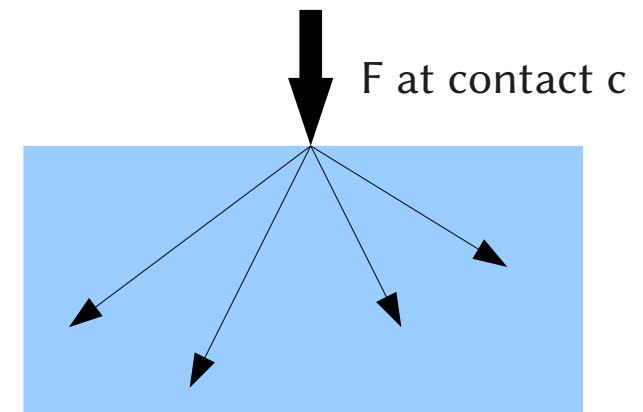

Displacement δ induced by F at distance d in the continuous elastic medium

THE MODEL

$$\delta_{k \rightarrow c} = -\frac{(1 + \nu)\delta_k \sqrt{\delta_k r_k}}{2\pi d_{kc}} \left\{ (\mathbf{n}_k \cdot \mathbf{u}_{kc}) (\mathbf{n}_c \cdot \mathbf{u}_{ck}) + (3 - 4\nu)\mathbf{n}_k \cdot \mathbf{n}_c - (1 - 2\nu) \frac{(\mathbf{n}_k + \mathbf{u}_{kc}) \cdot \mathbf{n}_c}{1 + \mathbf{n}_k \cdot \mathbf{u}_{kc}} \right\} \times \gamma$$

Linear Elasticity

$$F_c = E^* \sqrt{r_c^*} \left(\delta_L + \sum_{k \neq c} \delta_{k \rightarrow c} \right)^{3/2}$$

Geometric factor (to fit)
 $\gamma \approx 1.19$

Non-local contributions
 (same as in [Gonzales/Cuitiño])

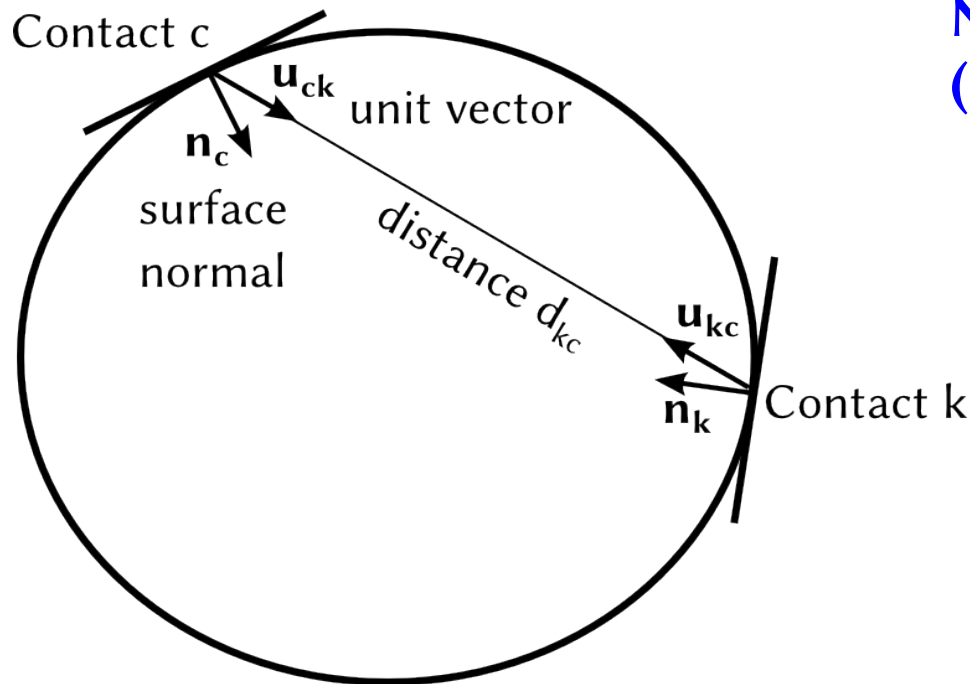

Notes

- $\delta_{k \rightarrow c}$ has no dependency on E
 \Rightarrow hard grains OK close to jamming
- γ may change with the packing fraction... not done yet
- Only validated for $\nu = 0.5$

QUESTIONS?

