



**HAL**  
open science

## Control of 1-D hyperbolic systems

Jean-Michel Coron

► **To cite this version:**

Jean-Michel Coron. Control of 1-D hyperbolic systems. NETCO 2014, 2014, Tours, France. hal-01024417

**HAL Id: hal-01024417**

**<https://inria.hal.science/hal-01024417>**

Submitted on 16 Jul 2014

**HAL** is a multi-disciplinary open access archive for the deposit and dissemination of scientific research documents, whether they are published or not. The documents may come from teaching and research institutions in France or abroad, or from public or private research centers.

L'archive ouverte pluridisciplinaire **HAL**, est destinée au dépôt et à la diffusion de documents scientifiques de niveau recherche, publiés ou non, émanant des établissements d'enseignement et de recherche français ou étrangers, des laboratoires publics ou privés.

# Control of 1-D hyperbolic systems

Jean-Michel Coron



Laboratory J.-L. Lions, University Pierre et Marie Curie (Paris 6)  
NetCo 2014

Conference on New Trends in Optimal Control, Tours, June 23-27, 2014



# Outline

- 1 Controllability of 1-D hyperbolic systems
- 2 Dissipative boundary conditions for 1-D hyperbolic systems
- 3 Stabilization of 1-D balance laws
- 4 An open problem: The stabilization of a 1-D water-tank system

- 1 Controllability of 1-D hyperbolic systems
  - The control system
  - Controllability
- 2 Dissipative boundary conditions for 1-D hyperbolic systems
  - The equations
  - Main result
  - Comparison with prior results
  - Proof of the exponential stability
  - Application to the control of open channels
- 3 Stabilization of 1-D balance laws
  - Balance laws and basic control Lyapunov functions
  - Stabilization of balance laws and backstepping
- 4 An open problem: The stabilization of a 1-D water-tank system

# The hyperbolic control system considered

Our hyperbolic control system is

$$(1) \quad y_t + A(y)y_x = 0, \quad (t, x) \in [0, T] \times [0, L],$$

where, at time  $t \in [0, T]$ , the state is  $x \in [0, L] \mapsto y(t, x) \in \mathbb{R}^n$ . Let  $y^* \in \mathbb{R}^n$  be fixed. Assume that  $A(y^*)$  has  $n$  distinct real distinct eigenvalues:  $\Lambda_1(y^*) < \dots < \Lambda_m(y^*) < 0 < \dots < \Lambda_n(y^*)$  for some  $m \in \{0, \dots, n\}$ . After a linear change of variables, we may assume that  $A(y^*) = \text{diag}(\Lambda_1(y^*), \dots, \Lambda_n(y^*))$ . For  $y \in \mathbb{R}^n$ , let  $y_- \in \mathbb{R}^m$  and  $y_+ \in \mathbb{R}^{n-m}$  be such that

$$y = \begin{pmatrix} y_- \\ y_+ \end{pmatrix}.$$

The control is  $y_+(t, 0)$  and  $y_-(t, L)$ .



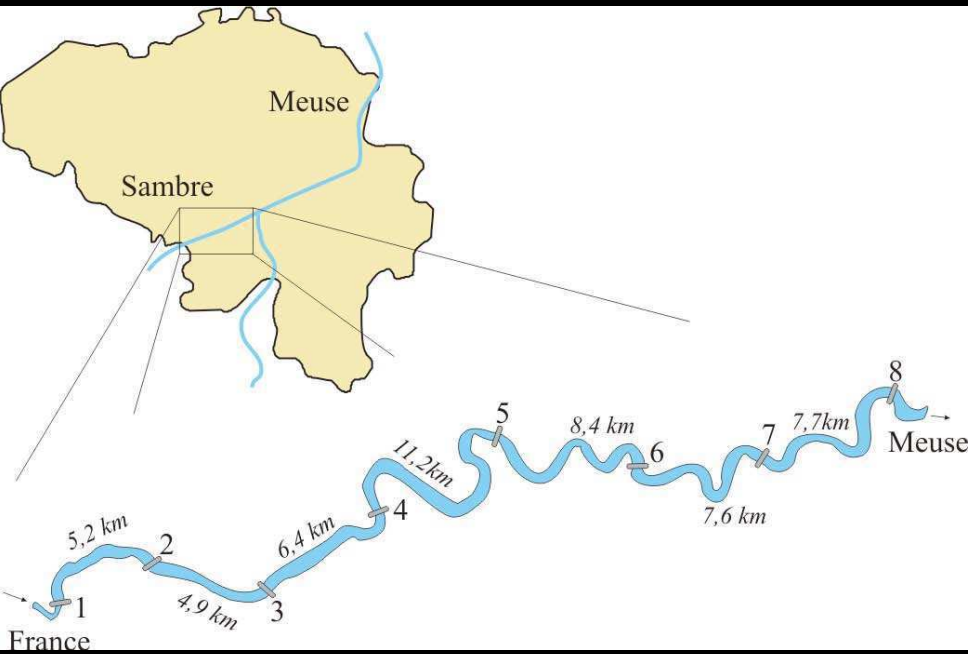

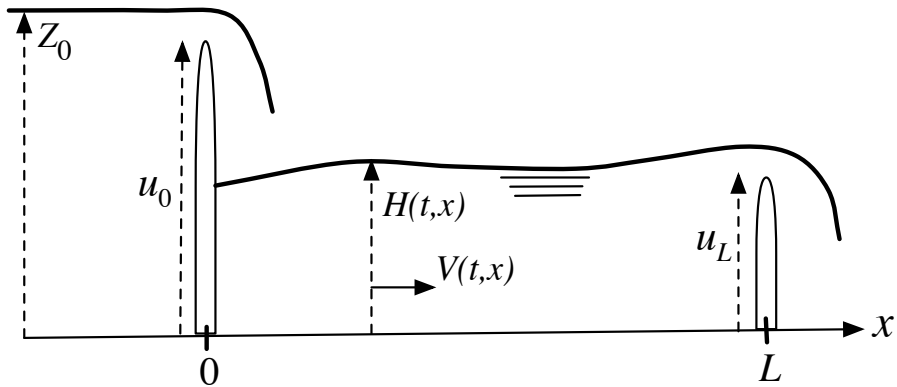



# The Saint-Venant equations

The index  $j$  is for the  $j$ -th reach.

Conservation of mass:

$$(1) \quad H_{jt} + (H_j V_j)_x = 0.$$

Conservation of momentum:

$$(2) \quad V_{jt} + \left( gH_j + \frac{V_j^2}{2} \right)_x = 0.$$

Flow rate:  $Q_j = H_j V_j$ .



Barré de Saint-Venant  
(Adhémar-Jean-Claude)  
1797-1886

Théorie du mouvement non permanent des eaux, avec applications aux crues des rivières et à l'introduction des marées dans leur lit, C. R. Acad. Sci. Paris Sér. I Math., vol. 53 (1871), pp.147–154.

# Riemann coordinates

Let  $l$  be the number of reaches. Let  $n = 2l$ ,

$$(1) \quad y_i = V_i - \sqrt{2gH_i}, \quad y_{i+l} = V_i + \sqrt{2gH_i}, \quad \forall i \in \{1, \dots, l\},$$

$$(2) \quad \Lambda_i = V_i - \sqrt{gH_i}, \quad \Lambda_{i+l} = V_i + \sqrt{gH_i}, \quad \forall i \in \{1, \dots, l\}.$$

Then the Saint-Venant equations can be written as

$$(3) \quad y_t + A(y)y_x = 0,$$

with

$$(4) \quad A(y) := \text{diag} (\Lambda_1(y), \dots, \Lambda_n(y)).$$

The flow is subcritical flow  $V_i < \sqrt{gH_i}$ ,  $\forall i \in \{1, \dots, l\}$ . For subcritical flows, one has  $m = l$ .

# La Sambre: Hydraulic gates



# Boundary conditions

Underflow (sluice)

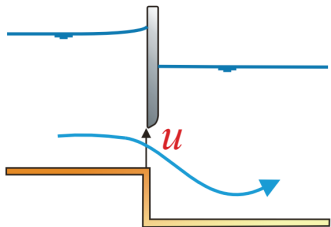

$$Q = K \sqrt{u(H_{up} - H_{down})}$$

Overflow (spillway)

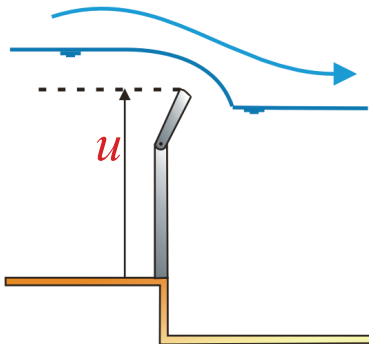

$$Q = K(H_{up} - u)^{3/2}$$

# The control problem

Let  $T > 0$ . Given  $y^0 : [0, 1] \rightarrow \mathbb{R}^n$  and  $y^1 : [0, 1] \rightarrow \mathbb{R}^n$ . Does there exist a solution of the control system such that  $y(0, x) = y^0(x)$  and  $y(T, x) = y^1(x)$ ? Local controllability:  $y^0$  and  $y^1$  are close to  $y^*$ .

## A very simple example

$$y_t + y_x = 0, \quad y(t, 0) = u(t), \quad x \in [0, L], \quad t > 0.$$

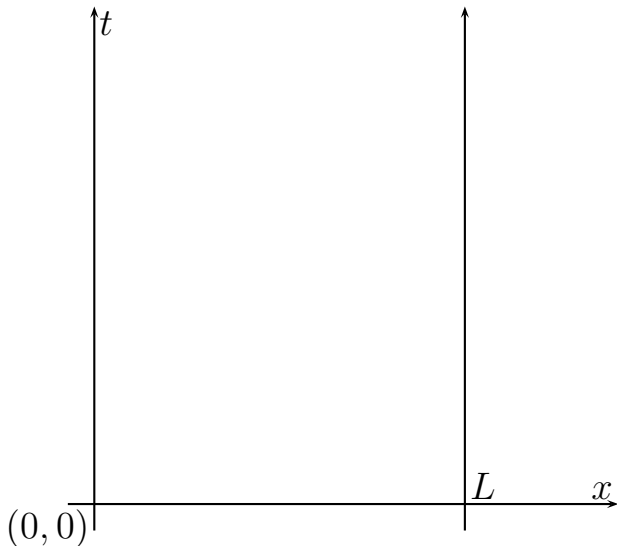

# A very simple example

$$y_t + y_x = 0, \quad y(t, 0) = u(t), \quad x \in [0, L], \quad t > 0.$$

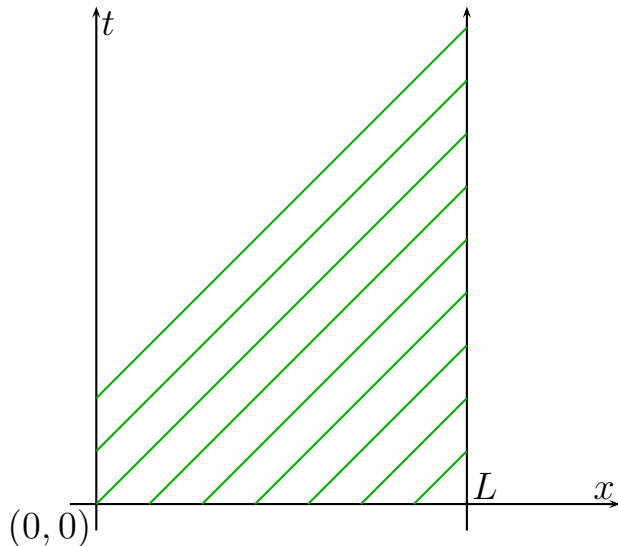



# A very simple example

$$y_t + y_x = 0, \quad y(t, 0) = u(t), \quad x \in [0, L], \quad t > 0.$$

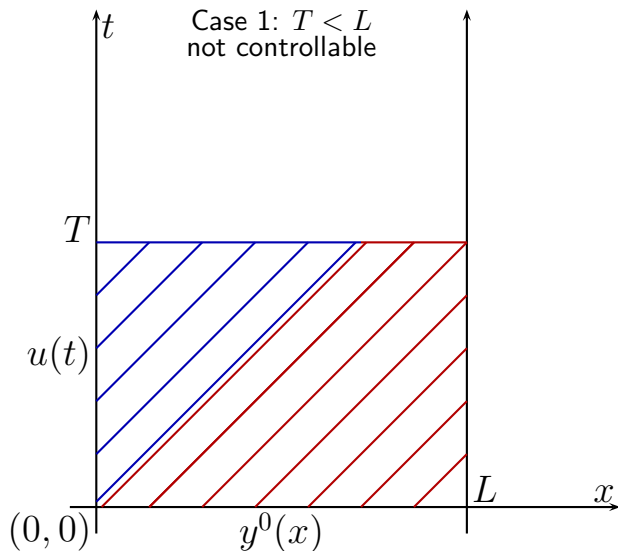

# A very simple example

$$y_t + y_x = 0, \quad y(t, 0) = u(t), \quad x \in [0, L], \quad t > 0.$$

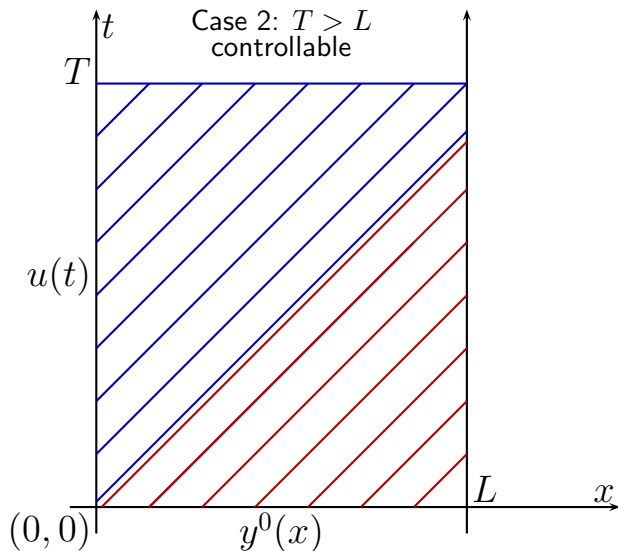

# Controllability theorem

## Theorem (Tatsien Li and Bopeng Rao (2003))

*The local controllability for the  $C^1$ -norm holds if and only if  $T > T_c$  with*

$$(1) \quad T_c := \max \left\{ \frac{L}{|\Lambda_1(y^*)|}, \dots, \frac{L}{|\Lambda_n(y^*)|} \right\}.$$

- For the control on one side only, see T. Li and B. Rao (2002).
- Global steady states controllability for the Saint-Venant equations: M. Gugat (2003), M. Gugat and G. Leugering (2003, 2009). Friction and slopes are allowed in the last paper.
- Generalization:  $A(t, x, y)$ : Z. Wang (2007).

## Complements: BV solutions

- F. Ancona and A. Marson (1998):  $y_t + f(y)_x = 0$ ,  $x \in (0, +\infty)$ ,  $y(0, x) = 0$ : reachable set.
- Th. Horsin (1998):  $y_t + (y^2/2)_x = 0$ ,  $x \in (0, L)$ ,  $y(0, x) = y^0(x)$ : approximate controllability under general conditions on the desired target.
- V. Perrollaz (2012):  $y_t + (f(y))_x = u(t)$ ,  $x \in (0, L)$ ,  $y(0, x) = y^0(x)$ : global controllability in small time.
- Adimurthi, S. Ghoshal and G. Gowda (2014):  $y_t + (f(y))_x = 0$ ,  $x \in (0, L)$ ,  $y(0, x) = y^0(x)$ : reachable set.
- A. Bressan and G. Coclite (2002): In the BV class of entropy solutions, already with  $n = 2$ , there are cases where one cannot steer the control system from  $y^0$  to  $y^*$  even if  $y^0$  is close to  $y^*$  (if one remains close to  $y^*$  in the BV-norm).
- O. Glass: One-dimensional Euler isentropic (2007) and non-isentropic system (2014), both in Eulerian and Lagrangian coordinates: Study of the controllability. Corollary: one can steer the control to  $y^*$  if  $y^0$  is close (in the BV-norm) to  $y^*$  (while remaining close to  $y^*$  in the BV-norm).

# Sketch of proof of Li-Rao's theorem

We assume that

$$(1) \quad T > \max\{L/|\Lambda_i(y^*)|; i \in \{1, \dots, n\}\}.$$

Let  $T_1 > 0$  be such that

$$(2) \quad T_1 > \frac{1}{2} \max\{L/|\Lambda_i(y^*)|; i \in \{1, \dots, n\}\},$$

$$(3) \quad 2T_1 < T.$$

Let us recall that, for  $y \in \mathbb{R}^n$ ,  $y_- \in \mathbb{R}^m$  and  $y_+ \in \mathbb{R}^{n-m}$  are such that

$$y = \begin{pmatrix} y_- \\ y_+ \end{pmatrix}.$$

# Sketch of proof (continued)

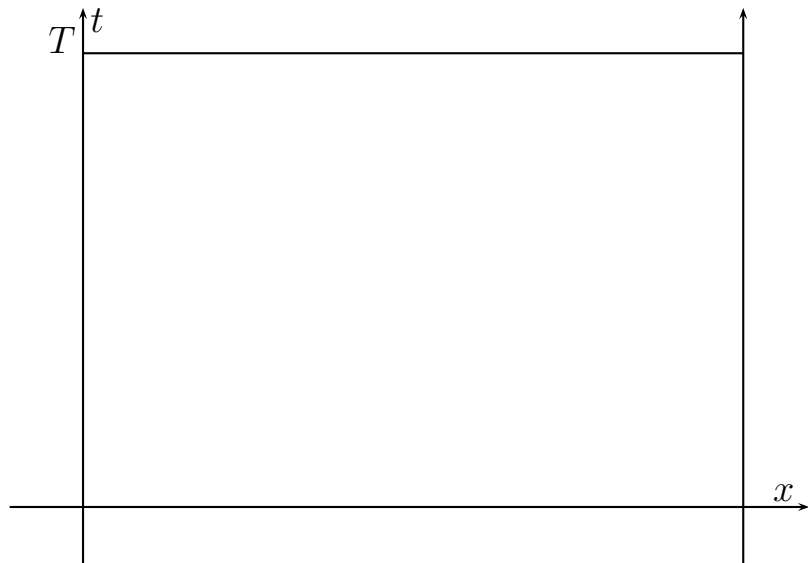

# Sketch of proof (continued)

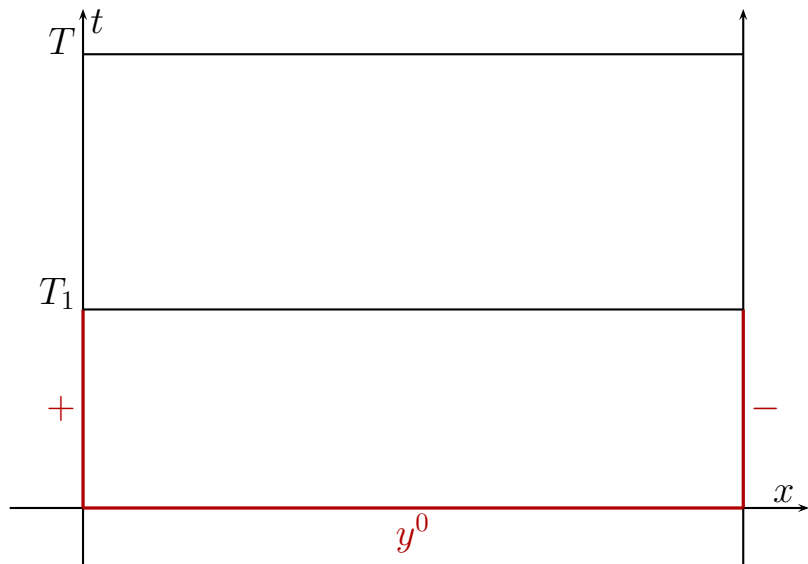



# Sketch of proof (continued)

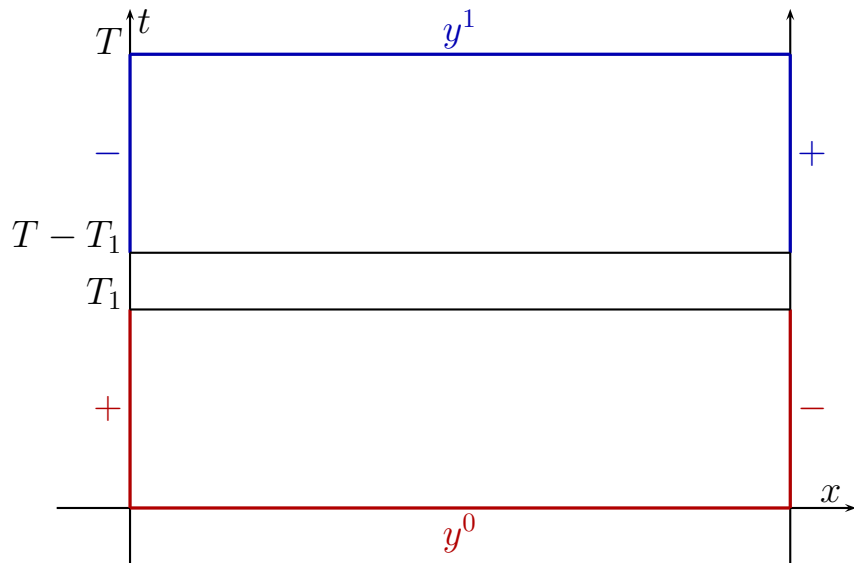

# Sketch of proof (continued)

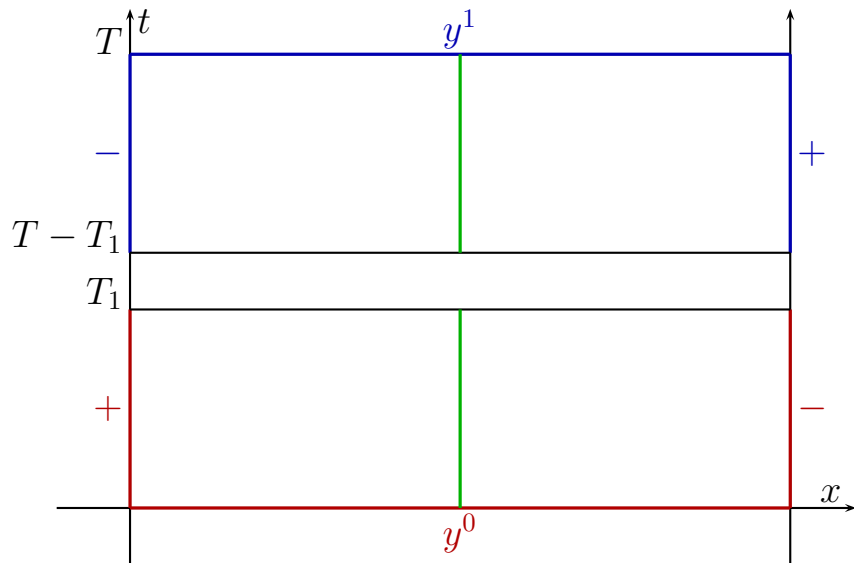

# Sketch of proof (continued)

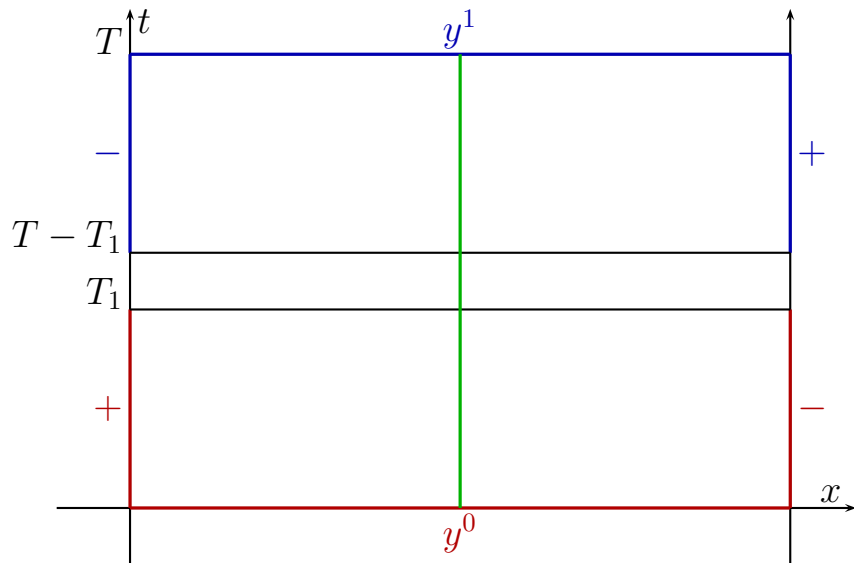

# Sketch of proof (continued)

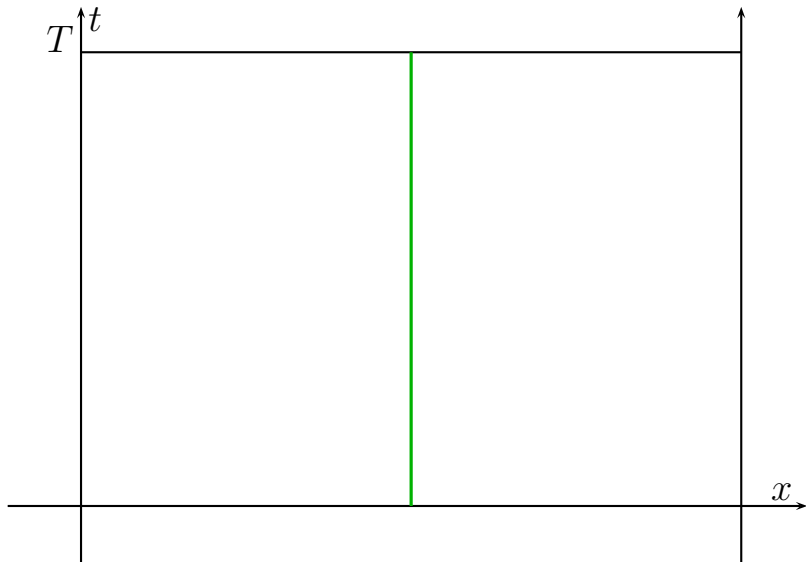

# Sketch of proof (continued)

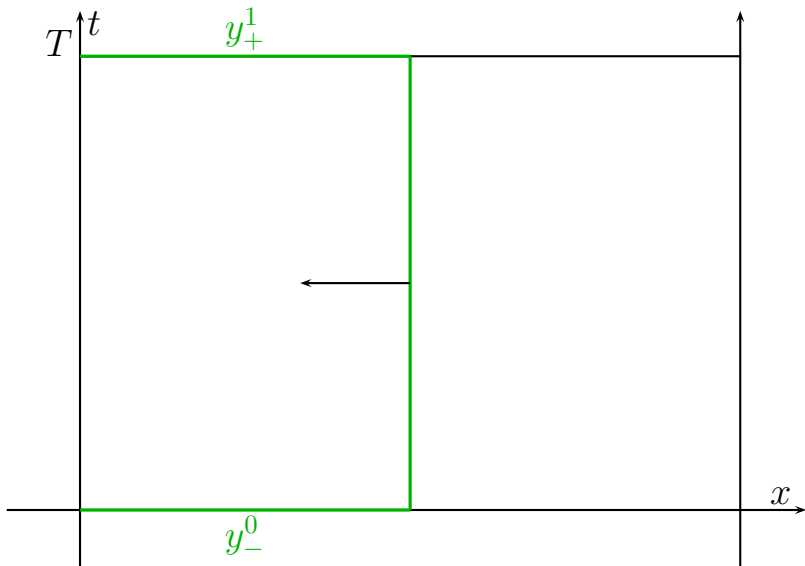

# Sketch of proof (continued)

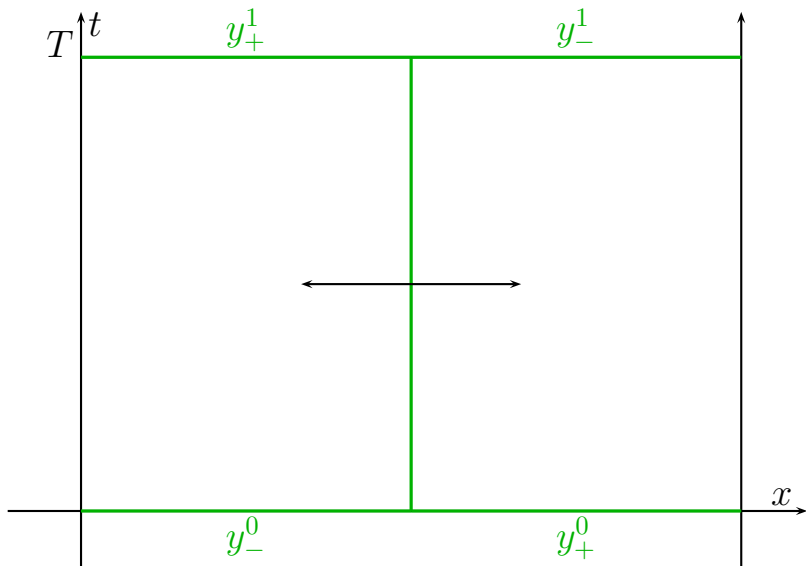

# Sketch of proof (continued)

$$T_1 > \max\{L/|\Lambda_i(0)|; i \in \{1, \dots, n\}\}/2.$$

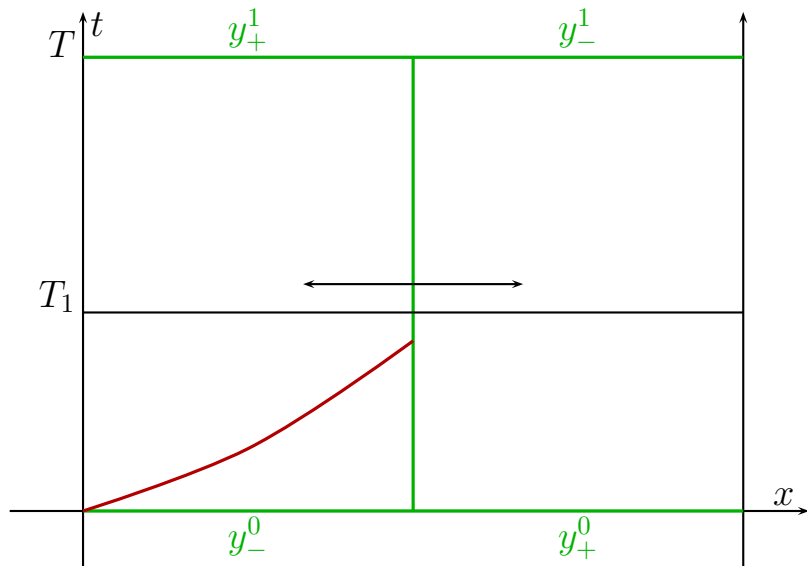

- 1 Controllability of 1-D hyperbolic systems
  - The control system
  - Controllability
- 2 Dissipative boundary conditions for 1-D hyperbolic systems
  - The equations
  - Main result
  - Comparison with prior results
  - Proof of the exponential stability
  - Application to the control of open channels
- 3 Stabilization of 1-D balance laws
  - Balance laws and basic control Lyapunov functions
  - Stabilization of balance laws and backstepping
- 4 An open problem: The stabilization of a 1-D water-tank system



# More on controllability and stabilization

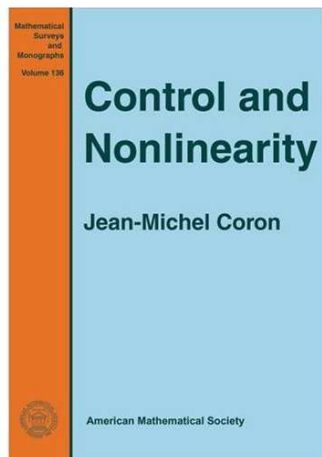

JMC, Control and nonlinearity, Mathematical Surveys and Monographs, 136, 2007, 427 p. Pdf file freely available from my web page.

# Double inverted pendulum (CAS, ENSMP/La Villette)

