



HAL
open science

Wireless and Autonomous Sensor for Strut Load Monitoring

William Bense, Nicolas Florent, Jean-Renaud Frutos, Yoann Hebrard

► **To cite this version:**

William Bense, Nicolas Florent, Jean-Renaud Frutos, Yoann Hebrard. Wireless and Autonomous Sensor for Strut Load Monitoring. EWSHM - 7th European Workshop on Structural Health Monitoring, IFFSTTAR, Inria, Université de Nantes, Jul 2014, Nantes, France. hal-01021202

HAL Id: hal-01021202

<https://inria.hal.science/hal-01021202>

Submitted on 9 Jul 2014

HAL is a multi-disciplinary open access archive for the deposit and dissemination of scientific research documents, whether they are published or not. The documents may come from teaching and research institutions in France or abroad, or from public or private research centers.

L'archive ouverte pluridisciplinaire **HAL**, est destinée au dépôt et à la diffusion de documents scientifiques de niveau recherche, publiés ou non, émanant des établissements d'enseignement et de recherche français ou étrangers, des laboratoires publics ou privés.

WIRELESS AND AUTONOMOUS SENSOR FOR STRUT LOAD MONITORING

William Bense¹, Nicolas Florent¹, Jean-Renaud Frutos², Yoann Hebrard³

¹ Snecma (Safran group), Rond point René Ravaud, 77550 Moissy Cramayel, France

² SilMach, 16 rue Sophie Germain, F-25000 Besançon, France

³ SKF Aerospace, 29 chemin de Thabor, 26000 Valence, France

william.bense@snecma.fr, nicolas.florent@snecma.fr,
jrfrutos@silmach.com, Yoann.Hebrard@skf.com

ABSTRACT

In case of hard landings, engine mounts or landing gears can be damaged and must be inspected as the severity of landing is not well estimated based on aircraft inertial system and models. Such inspections can be time consuming and generate delays, cancellations and inappropriate maintenance actions that could be avoided if a sensor is able to measure the accurate load level sustained by the equipment. The aim of the project is to develop an autonomous wireless sensor with local intelligence and storage capacity that can be downloaded upon request. A micro-mechanic MEMS sensor (chronoMEMS), using cogwheels, has been implemented: when a predefined level of load is reached, the sensor increments a counter. To validate the discrete information given by this sensor, strain gauges have been added. Interrogating the sensor must be easy and fast so that a wireless interrogating system based on RFID has been chosen. An Energy Harvesting system transforming Thermal and Vibration into electric power has been developed to supply the strain gauges and the memory (chronoMEMS does not require power).

Lab tests have been done on thermal and vibration energy harvesters. RFID transmission in the engine area is yet under studies and tests. The next step is to develop a prototype of a full sensor integrating all these parts working together in the engine harsh environment.

This technology could be used to monitor any kind of load charge for which real time surveillance is not necessary. Snecma (Safran Group) is the leader of this project allied to SilMach and SKF Aerospace. SilMach develops the chronoMEMS load sensor. SKF Aerospace is in charge of strain gauges, energy harvesting, RFID modules and complete system assembly.

KEYWORDS : *load counter, health monitoring, wireless sensor*

INTRODUCTION

Aircraft operational reliability is a main concern in aeronautics industry. Health monitoring i.e. system detecting premises of failure is the key tool for improving the level of aircraft operability. Monitoring systems combines sensors diagnosis/prognosis algorithms and data management (see [1] and [2] for details about monitoring algorithms). This article focuses on the sensor part and particularly on an autonomous load sensor currently under development. Measuring load can have a high value to estimate the remaining useful life of equipments like suspension rods or landing gears after a hard landing for instance. Indeed after such an event, aircraft companies need to know if suspension rods/landing gears are safe or could have been damaged (ref [3] gives information about inspection procedure). The goal of the project is to develop an autonomous sensor able to measure load that would help to reduce maintenance actions. This project is managed by Snecma (Safran group) in partnership with SilMach and SKF Aerospace.

1 ARCHITECTURE

The aim of the project is to develop a technology to optimize maintenance actions. So the way to use the strain sensor and particularly to interrogate it is really important: reading the strain value of the sensor shall not add maintenance constraints. For that, a wireless system has been chosen. Furthermore, the system does not require any external power supply. So the developed system is not only a sensitive part but a complete autonomous and wireless device.

The device is architected with the following sub-systems (see figure 1):

- **A strain sensor called chronoMEMS.** This micro-mechanical sensor is able to detect and count the number of strain threshold overrides. As it is based on a mechanical system, no power supply is required for the sensitive part. The number of threshold overrides can be read directly on the sensor but it is really small and the operator must be very close to the sensor or use glasses/camera. So a wireless transmission system and an encoder to translate the value of the sensor into a digital value have been added.
- **A strain gauge.** The project is under development and to secure the measure and be able to compare the value of chronoMEMS to a known reference, a classic strain gauge is added.
- **An Energy harvesting system** to supply the additional strain gauge and the non volatile memory. Energy is harvested from vibrations and thermal differences of the engine.
- **Data and power management system.** Sensors data are stored into a NVM that will be interrogated using a wireless RFID transmission. Energy harvesters provide energy but it must be stored and managed to supply strain gauge and memory. All these parts are managed by an integrated electronic device.
- **An interrogating system.** It is a RFID interrogator and is not embedded into the road but approached by an operator.

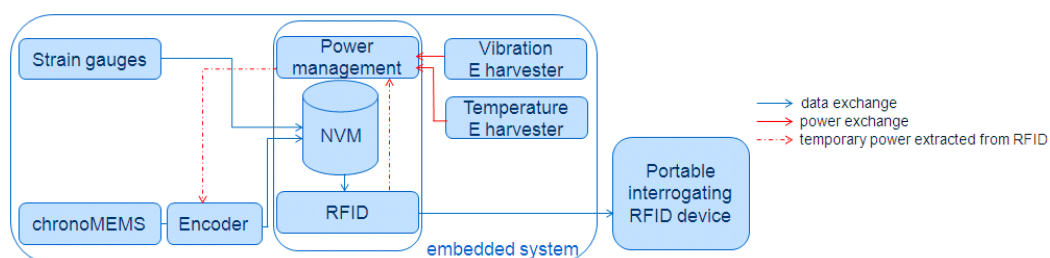

Figure 1: Architecture of the device. RFID module can provide energy when interrogated. The encoder is supplied only by this energy when interrogation is performed.

2 STRAIN SENSITIVE ELEMENTS

2.1 ChronoMEMS technology

ChronoMEMS is a fully autonomous and passive sensor, developed by SilMach and the DGA, designed for Health and Usage Monitoring applications (see [4] and [5]). It is a micro-mechanical sensor which does not need electronics or energy supply for its own functioning: it takes its own mechanical sensing energy from the deformations of the structures it monitors. Furthermore, it belongs to miniaturized "Stick and Forget" sensors which do not need any wiring. ChronoMEMS can detect, count and records all type of events like: impacts, mechanical vibrations or mechanical and/or thermal deflections. In this project, it is intended for Health Monitoring of aircraft equipments by detecting, counting and recording strain threshold overrides. When the monitored structure is mechanically loaded by a suspension rod for example, the ChronoMEMS sensor will only detect, count and record strains that override the thresholds defined during the development. Relevant strain thresholds are chosen depending on the health monitoring strategy (few number of high strain level events and/or numerous events of low strain level for instance). Output data are

simply reduced to couples {level of strain ; number of strains} that can be easily implemented in a fatigue model. Then ChronoMEMS sensor gives very compact information on the monitored structure. The core of the ChronoMEMS strain sensor is composed with a micro cog wheel that will display the number of strain threshold overrides (see figures 2 and 3).

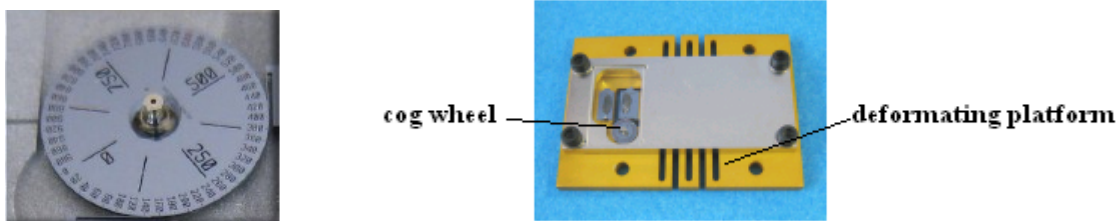

Figure 2 : ChronoMEMS micro cog wheel. One strain threshold overrides corresponds to one cog on the micro wheel. Strain threshold level is defined by the pitch of the cog wheel.

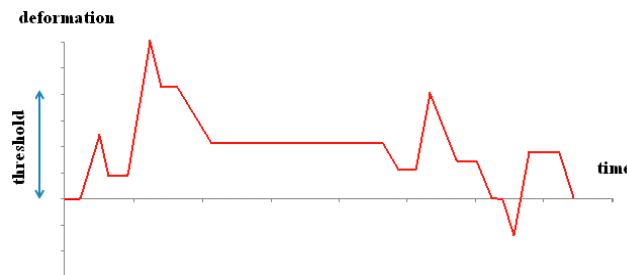

Figure 3: for the given threshold, the counter will detect only 1 threshold override for the example given cycle.

2.2 Strain gauge

ChronoMEMS is an innovative sensor which has not been tested on an aircraft engine yet. Then a strain gauge has been added on the test device in order to be able to compare its value to a conventional measure. Furthermore, the project tests several new technologies for aerospace like wireless transmission and energy harvesting.

2.3 Energy harvesting

Strain gauges and Non Volatile Memory require energy supply. Energy harvesting has been chosen to facilitate sensor integration and limit engine wires. Two sources had been considered: vibration and heat.

2.4 Vibration Harvesters

Regarding the micro-generators powered by mechanical source, piezoelectrics seems to be the most appropriate element in terms of performance, simplicity, and low cost productions. For the thermal case, thermoelectricity based on Seebeck effect has advantages over pyroelectricity thanks to its technological maturity for quickly getting industrialized solutions. Finally, both technologies have been selected for their robustness and their resistance to environmental conditions.

The operating principle of a piezoelectric generator is based on the direct piezoelectric effect, i.e. the internal generation of electrical charge resulting from an applied mechanical. Two families of piezoelectric micro-generator can be found. The first one, named direct coupling, is directly bonded to the host structure (Figure 4 a). The second, called indirect or seismic coupling, is connected to the host structure through a secondary element, e.g. a beam (Figure 4 b).

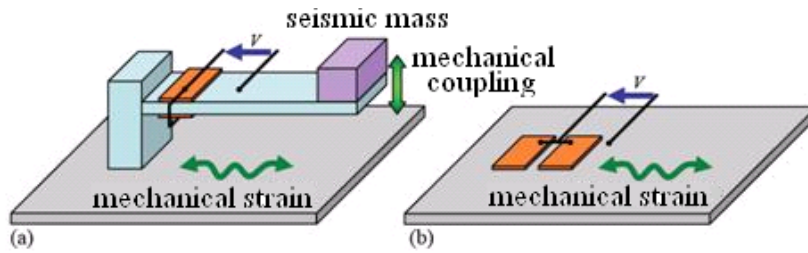

Figure 4. Kind of coupling : (a) seismic ; (b) direct

The piezoelectric elements provide substantial power densities ($250\mu\text{W}/\text{cm}^3$ at 120Hz and $2.5\text{m}/\text{s}^2$), which makes them particularly attractive for various energy harvesting applications. Seismic coupling had been selected for the vibration harvester, as it can provide up to ten times more energy than the classical method. Details on vibration energy harvesting can be found on ref [6] and [7]. To keep a stable voltage value, the technique of Synchronized Switching Harvesting on Inductor is used: an electronic switch is synchronously commanded with the vibration and connects briefly the piezoelectric module to an inductance leading to voltage inversion and keeping voltage value stable.

2.5 Thermal harvester

Thermal harvester principle is to convert heat flux between two different temperature points into electricity. It is called Seebeck effect presented in figure 5 (one can refer to ref [8] for more details)

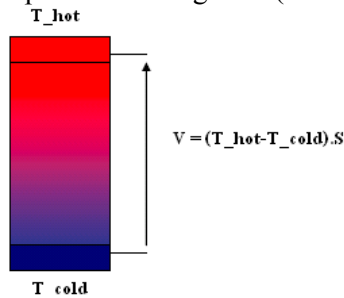

Figure 5. Illustration of Seebeck effect where S is the Seebeck coefficient

As engine is hot, energy will be generated using two points at different temperatures.

2.6 Power storage

A super capacitor (tens of μF) will store the converted electrical energy for phases when vibration and thermal differences are not sufficient for system power supply.

2.7 Power reduction

To be able to power a system with energy harvesting, a key step is also to reduce power consumption. On this project electronics and the RFID platform has been integrated into an ASIC to minimize main function consumptions. The following paragraph details the electronic architecture.

3 DATA AND POWER MANAGERMENTS

Data and power are managed thanks to the following elements (illustrated into figure 6):

- RFID Tag: it is a small radio device also called transponder or smart tag (one can refer to ref [9] for general details about RFID technology). The tag includes a microchip managing RF communications and a flat aerial. Project tag works in the Ultra-High Frequency (UHF) band - 860 MHz to 950 MHz - as this band offers the best compromise in power consumption with a high range - approximately 10 meters in free environment. (Details on RFID frequencies can be found on [10] and on aerospace standards on ref **Erreur ! Source du renvoi introuvable.**).
- An electronic platform (microcontroller, volatile memory, power management circuit, strain gauge conditioning circuit) - this platform locally counts the strain threshold crossings and stores it into a non-volatile memory.

Note about NVM: ChronoMEMS is a mechanical system which stores the total load that has been experienced by the monitored equipment. If an operator checks its value after each flight, there is no need for memory. But in the idea of reducing maintenance actions, a Non Volatile Memory has been added. Thanks to this NVM, the operator has the complete history of the load, can identify when exactly happened a high load, and does not need to download the value after each flight. Furthermore, a strain gauge has been added in the prototype and such equipment requires a memory to store its value.

Electronic platform can be energized in two ways depending on the operational phase:

- When engine is ON: energy is provided by energy harvesting modules
- When engine is OFF: energy harvester cannot supply energy for the chronoMEMS encoding system nor NVM or the electronic platform. But RFID technology gives the possibility to harvest energy from the interrogating radio frequency wave. When engine is off, energy is provided through the RFID link.
- Reader or Interrogator: it sends and receives Radio Frequency data to and from the tag using antennas. A reader may have several antennas that sends and receives radio waves.

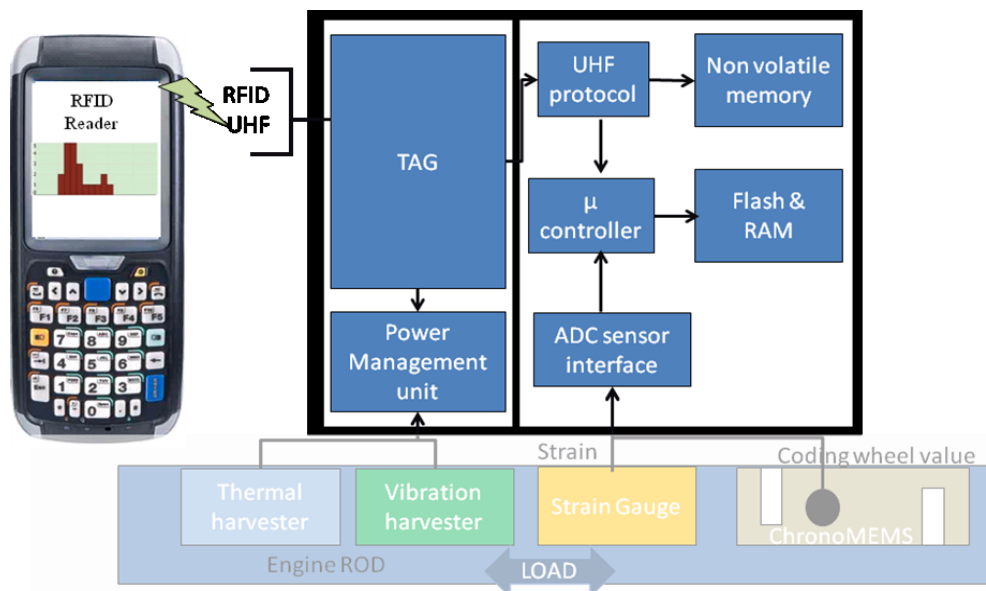

Figure 6. Links between modules

4 TESTS

Wireless load sensors could be used for various applications, like suspension rod and landing gear. For the context of the project, strut load will be used for tests as their deformation is directly dependent from the thrust that can be controlled during test phases on an engine more easily than the deformation due to a hard landing on suspension rod for instance. Furthermore, hard landing tests are risky for the engine and much more expensive than thrust tests. (figure 7 presents suspension rod and strut load)

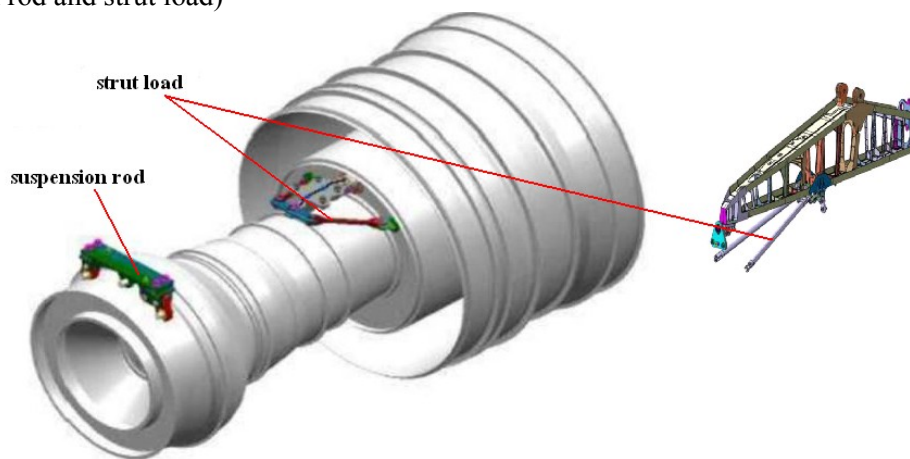

Figure 7. Suspension rod and strut load

Last year, lab tests of main technologies have been done – results are presented in the following paragraph.

4.1 chronoMEMS tests

The first step was to test if the sensing element is able to detect strain threshold crossing. Several cycles around the predefined threshold for the test, have been applied with a hydraulic press (see figure 8)

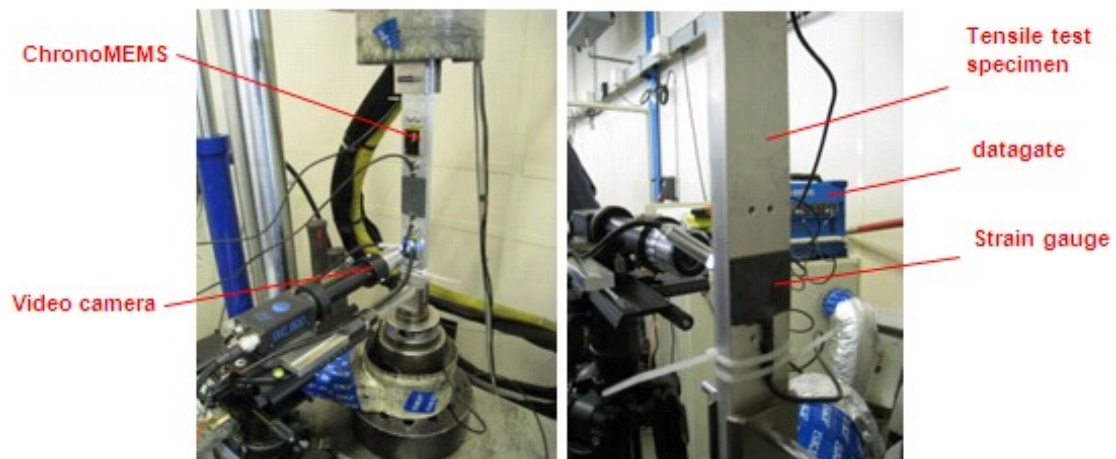

Figure 8. Test device

Counted cycles complied with the applied cycles (see figure 9) and confirmed the ability of the sensor to be used.

4.2 Energy harvesting tests

Estimated required power is around 1 mW when the system is working and some μW for sleep mode.

Tests have been realized to check if vibration and temperature could supply such amount of energy. For vibration a shaker device simulated vibrations that could occur. For an excitation of 1g, the measured harvested energy was around 500 μW . So with a limited number of vibration energy harvesters, the system can be supplied.

For thermal harvester, a rod mounted with the thermoelectric system has been heated (see figure 10). Around 3°C should be necessary for system a mW supply.

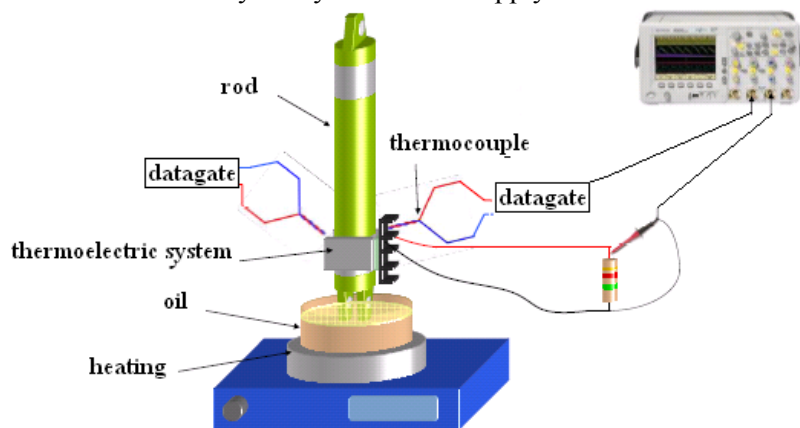

Figure 10. Thermoelectric tests

5 CONCLUSION

At this day, each element of the project have been developed: Now they have to be integrated and packaged together in a minimum volume compatible with strut environment, demonstrate the correct behaviour in lab and then in a real test engine. It is a real challenge but building wireless embedded sensors would have a great value in aeronautics industry. Wireless sensors will be key for future health monitoring services: they give the possibility to monitor new components, to add new sensors on the engine as the mass is reduced and there is no wire to install. They could be useful not only on for operational engines but also during test phases for their quick installation/removal. Success of the project will begin to open this way.

ACRONYMS

Acronyms	Description
ASIC	Application Specific Integrated Circuit
DGA	Direction Générale de l'Armement
MEMS	MicroElectroMechanical System
NVM	Non Volatile Memory
RF	Radio Frequency
RFID	Radio Frequency Identification
UHF	Ultra High Frequency

REFERENCES

- [1] J. Lacaille. «Standardized failure signature for a turbofan engine», IEEE Aerospace conference, 2009
- [2] W. Bense. "Prognosis and Health Monitoring Systems for Aircraft Engines", SAE Aerotech, 2013
- [3] http://www.boeing.com/commercial/aeromagazine/aero_14/conditional.pdf
- [4] <http://www.gouvernement.fr/gouvernement/des-patches-pour-mesurer-la-fatigue-des-ponts-autoroulants-de-l-armee-de-terre>
- [5] <http://www.defense.gouv.fr/salle-de-presse/communiqués/ministere/chronomems-une-innovation-pour-la-maintenance-en-premiere-mondiale>
- [6] M. N. Lallart. « Amélioration de la conversion électroactive de matériaux piézoélectriques et pyroélectriques pour le contrôle vibratoire et la récupération d'énergie - Application au contrôle de santé structurale auto-alimenté » INSA Lyon, 2008.
- [7] M. Lallart. « Small-Scale Energy Harvesting », 2012.
- [8] G. Sebald, D. Guyomar, and A. Agbossou. « On thermoelectric and pyroelectric energy harvesting » Smart Materials and Structures, vol. 18, no. 12, p. 125006, Dec. 2009.
- [9] <http://www.rfidc.com/docs/rfid.htm>
- [10] <http://www.centrenational-rfid.com/les-gammes-de-frequences-rfid-article-16-fr-ruid-17.html>
- [11] PREN 4817 Aerospace series - Passive UHF RFID Tags Intended for Aircraft Use.