



HAL
open science

Piezoelectric Paint Sensor for Impact and Vibration Monitoring

Lae-Hyong Kang, Jyung-Ryul Lee

► **To cite this version:**

Lae-Hyong Kang, Jyung-Ryul Lee. Piezoelectric Paint Sensor for Impact and Vibration Monitoring. EWSHM - 7th European Workshop on Structural Health Monitoring, IFFSTTAR, Inria, Université de Nantes, Jul 2014, Nantes, France. hal-01020382

HAL Id: hal-01020382

<https://inria.hal.science/hal-01020382>

Submitted on 8 Jul 2014

HAL is a multi-disciplinary open access archive for the deposit and dissemination of scientific research documents, whether they are published or not. The documents may come from teaching and research institutions in France or abroad, or from public or private research centers.

L'archive ouverte pluridisciplinaire **HAL**, est destinée au dépôt et à la diffusion de documents scientifiques de niveau recherche, publiés ou non, émanant des établissements d'enseignement et de recherche français ou étrangers, des laboratoires publics ou privés.

PIEZOELECTRIC PAINT SENSOR FOR IMPACT AND VIBRATION MONITORING

*Lae-Hyong Kang^{1,2}, Jyung-Ryul Lee^{1,2,3}

¹LANL-CBNU Engineering Institute Korea, Chonbuk National University

²Department of Mechatronics Engineering, Chonbuk National University

³Department of Aerospace Engineering, Chonbuk National University
664-14 Duckjin-dong, Duckjin-gu, Jeonju, Chonbuk 561-756, Republic of Korea

reon.kang@jbnu.ac.kr

ABSTRACT

This paper presents a fabrication method for a piezoelectric paint sensor, and its application to impact and vibration monitoring of a beam structure. The piezoelectric paint in the paper is composed of $\text{Pb}(\text{Nb},\text{Ni})\text{O}_3\text{-Pb}(\text{Zr},\text{Ti})\text{O}_3$ (PNN-PZT) powder and epoxy resin. The piezoelectric paint has been coated on an aluminum beam structure, and the electrode has been made on the upper surface of the piezoelectric paint using silver paste. By using the aluminum structure as the opposite electrode, the poling of the PNN-PZT/Epoxy paint has been conducted successfully at room temperature with the electric field of 4 kV/mm for 30 min. When the cantilevered aluminum beam was under several vibration conditions, especially resonance, the vibration response has been monitored by measuring the output voltage from the piezoelectric paint sensor. The output voltage responses to the in-plane deformation(strain) of the beam structure, so the displacement-strain transformation technique has been used in order to obtain out-of-plane deformation. The transformed out-of-plane deformation from the paint sensor was compared with the measured from laser displacement sensors at a certain beam position. The results showed that the estimated data matches the measured and, moreover, the deformations at various points along the beam length also can be obtained from the displacement-strain transformation technique. In addition to the vibration, impact signal also can be easily monitored using the piezoelectric paint, because the piezoelectric paint is inherently more sensitive to higher frequency signals. By using the impact hammer, several impacts have been applied to the beam structure. The impact monitoring test results showed that the impact force signal over 10N can be captured using the piezo-paint.

KEYWORDS : *piezoelectric, paint, sensor, impact, vibration*

INTRODUCTION

Piezoelectric materials convert the mechanical energy to the electrical energy, and vice versa. Due to their electromechanical coupling characteristics, the piezoelectric materials can be used for various sensor and actuator applications. When the piezoelectric materials are used as sensors, the sensor signal in response to mechanical loads can be obtained without any external power source, so the total sensor system can be smaller and lighter. For this reason, the piezoelectric sensors are widely used and valuable for applications where power consumption is significantly constrained. Piezoelectric materials include ferroelectric ceramics, polymers, and composites. Ferroelectric ceramics have good piezoelectric responses but they are brittle and heavy, and are not able to be applied to the curvature or the structures with complex geometry. Piezoelectric polymers are flexible, but generally vulnerable to the severe environment and have lower electromechanical

coupling properties. Piezoelectric composite is formed as a combination of both ferroelectric ceramics and polymer in order to overcome disadvantage of the ceramics and the polymers, and meet the desirable piezoelectric material properties which cannot be attainable in a single-phase material. The mechanical and electrical properties of a composite depend on the characteristics of each phase and their connectivity. The piezoelectric paint is a kind of the piezoelectric composites, and belongs to piezoelectric 0-3 composite materials. The first and second numbers in the connectivity denote the continuity of the piezoelectric and polymer phases, respectively. The 0-3 composites are made of a homogeneous distribution of piezoelectric ceramic particles within a polymer matrix. Typical 0-3 composites are the materials or structures which are already formed with certain shapes so that they have to be cut to desired dimensions and bonded onto host structures for such a vibration measurement. On the other hand, the piezoelectric paint concerned here is that it is very flexible, liquid type adhesive, and can be applied to various complex shapes of structures. The primary advantage of 0-3 composites including piezoelectric paint is that they can be formed into various and complex shapes and still retain their piezoelectricity. However, they cannot be sufficiently poled or difficult to be poled because the ceramic phase is not self-connected in the poling direction[1].

Some researchers[2-4] have developed piezoelectric paint sensors and investigated on the poling of the piezoelectric paint sensors. White et al.[2] uses PZT5A type powder provided by Morgan Electro Ceramics Ltd., and a water-based acrylic produced by Rohm and Haas, and PZT powder-lacquer compositions with weight ratios lying between 1:1 and 4:1 were investigated. The poling was conducted with an electric field of 5-10kV/mm at an elevated temperature of 40-50°C by placing 150W lamp close to the sensor for 1-5s (sometimes up to 1,000s). Payo et al.[3] uses PKI-502, commonly known as "Navy type II", similar with PZT5A, by Piezo Kinetics Inc. and acrylic paint base (weight ratio of PZT:resin=13:7) provided by Rohm and Haas with various additives (coalescent, plasticizer, dispersant, surfactant, deformer and neutralizer) required for a viable paint. The piezoelectric coating was poled with an electric field of 5kV/mm at room temperature for 10 s (after some tests varying the poling time). Zhang[4] uses PZT5A powder and epoxy resin (weight ratio of PZT:resin=7:3) for piezoelectric paint sensor, and the poling was performed at an elevated temperature of 80°C.

Although various researches on the piezoelectric paint sensors have been conducted as described above, the piezoelectric paint sensors are still heavy and expensive, and usually high temperature and large electric field are needed for poling. In order to perform the poling at lower temperature with lower electric fields, more soft type piezoelectric material was used in this study, and the weight percent between PZT powder and resin was chosen as 1:1 for weight reduction.

FABRICATION OF THE PIEZOELECTRIC PAINT SENSOR

Piezoelectric material can be simply classified into two groups: soft type piezoelectric material; and hard type piezoelectric material. Soft type piezoelectric material can be obtained using donor ions (La^{3+} into the A site, or Nb^{5+} or Sb^{5+} into the B site) as additives in the ABO_3 perovskite structure, and has larger electromechanical coupling factors, larger piezoelectric strain coefficient, and easy to be poled. Hard type piezoelectric material can be obtained using acceptor ions (K^+ or Na^+ at the A site, or Fe^{3+} , Al^{3+} , or Mn^{3+} at the B site), and has smaller electromechanical coupling factors, smaller piezoelectric strain coefficient, and difficult to be poled[1]. The soft type piezoelectric material is suitable for the piezoelectric paint manufacturing due to its easier polarization and higher electromechanical properties. In this study, Nb_2O_5 were used for the soft type piezoelectric material[5,6], and mixed with PbO , TiO_2 , ZrO_2 , and NiO (all produced by Sigma Aldrich), which reduces the sintering temperature[6]. Table 1 shows the weight percent of each material for the PNN-PZT powder, and the overall test procedure in this study is summarized in Figure 1. The sintering process was conducted at 1,000°C in the muffle furnace (DF-3A, DAEHUNG.SCIENCE

Corp.), and the PNN-PZT powder before sintering is shown in Figure 2. The PNN-PZT powder after sintering was mixed with epoxy (KFR-120 with KFH-150, Kukdo Chemical Co., Ltd.) in the vacuum desiccator to remove the voids inside the paint mixture as shown in Figure 3, and then the piezoelectric paint was applied onto the aluminum beam surface with electrode (silver paste ELCOAT P-100, CANS). Finally, the poling has been performed successfully at room temperature with 4kV/mm in 30 min. using high voltage DC power supply (HCN-140, Fug). After the poling process, the piezoelectric paint sensor can act as a sensor to monitor impact or vibration.

Table 1: Weight percent of 5 raw materials for the PNN-PZT powder.

Material	PbO	Nb ₂ O ₅	NiO	ZrO ₂	TiO ₂
Weight percent (%)	66.91	14.46	6.10	4.98	7.54

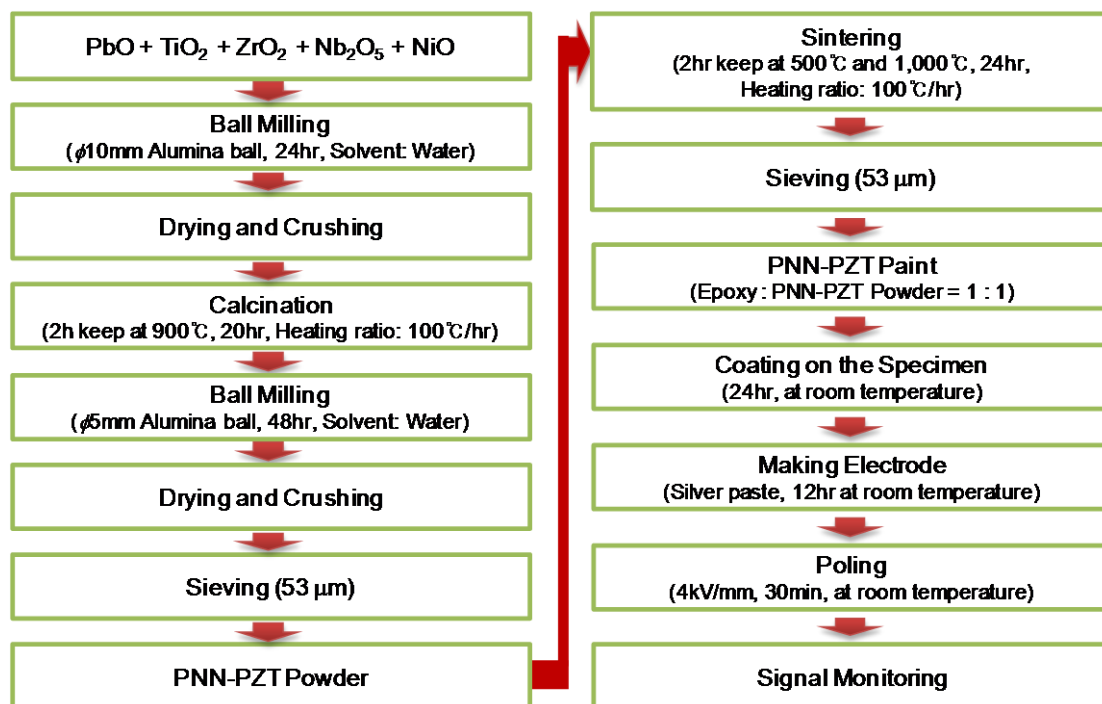

Figure 1: Overall experimental procedure for the PNN-PZT paint sensor.



Figure 2: PNN-PZT powder.



Figure 3: Piezo-paint in the vacuum desiccator.

IMPACT MONITORING USING THE PIEZOELECTRIC PAINT SENSOR

The dimensions of the aluminum specimen with the piezoelectric paint sensor are illustrated in Figure 4. The piezoelectric paint sensor (thickness: 0.15mm) coated on the aluminum beam was divided into 6 parts to detect impact location, and there are 1mm electrode gaps between each adjunct sensors. When the impact hammer(086C01, PCB Piezotronics, Inc.) with soft tip hits the piezoelectric paint sensor, the output voltage from the paint sensor was obtained. From the test results, the voltage output from the sensor at impact region was significantly bigger than others. It means that the impact region can be easily distinguished, and thus the piezoelectric paint sensor can be used for impact region detection. Figure 5 shows one of the test results when impact force applied to S1. The experimental results showed that the impact force over about 10N can be detected using the piezoelectric paint sensor.

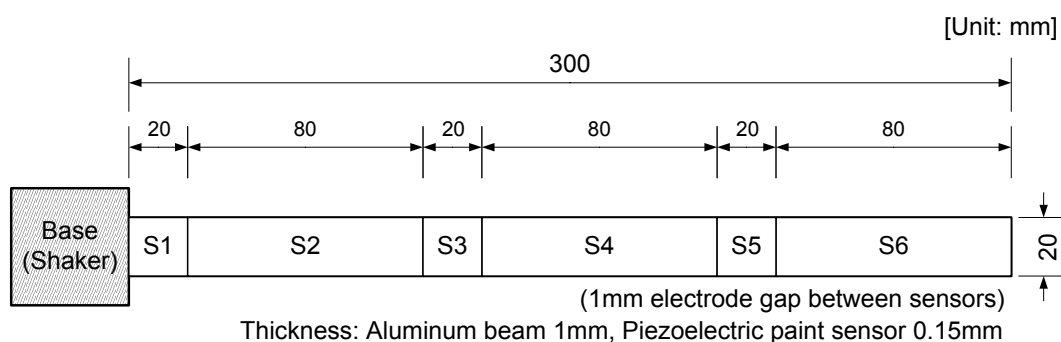

Figure. 4: Dimensions of the cantilevered beam structure.

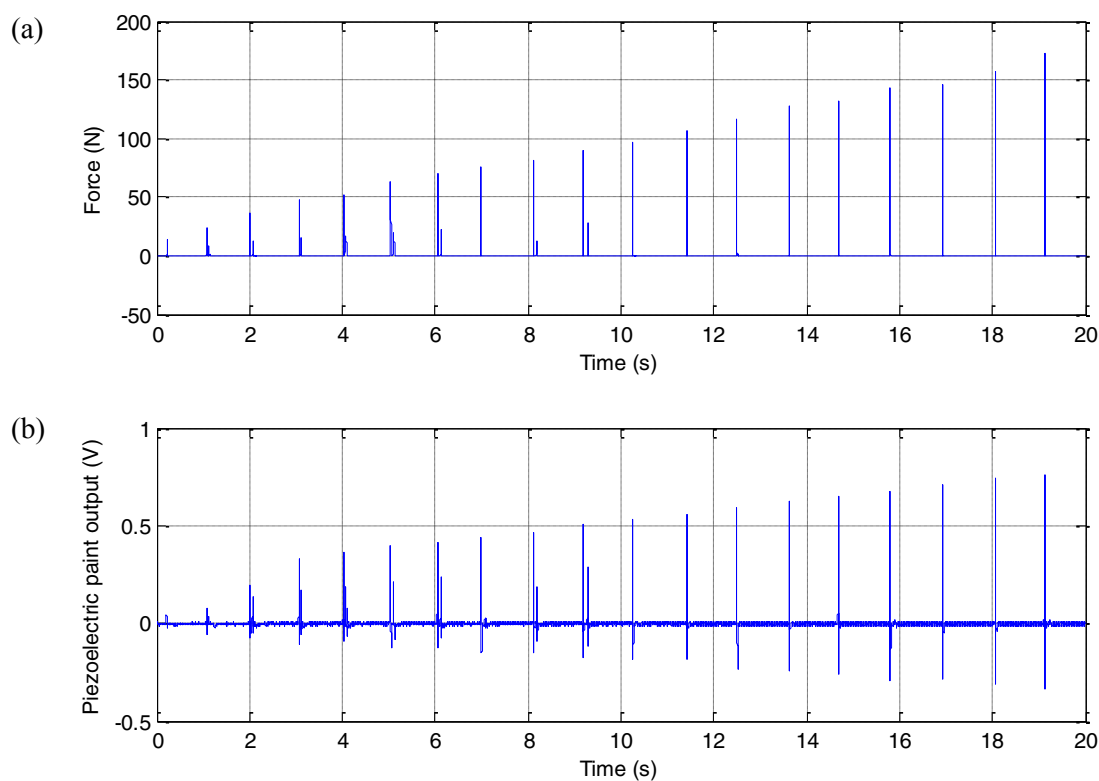

Figure. 5: Impact monitoring when impact occurs at S1: (a) applied force; (b) piezo-paint output.

VIBRATION MONITORING USING THE PIEZOELECTRIC PAINT SENSOR

Vibration of the cantilevered aluminum beam structure has been estimated using the output voltages from the piezoelectric paint sensors, and validated with the measurement data. The aluminum beam structure has the dimensions of $0.3 \times 0.02 \times 0.001 \text{m}^3$, the density of $2,700 \text{kg/m}^3$, and the elastic modulus of 68 GPa. Using these dimensions and material properties, the first 3 natural frequencies and mode shapes were calculated from the analytical solution of the cantilevered beam structure. Experimental natural frequencies were obtained from the frequency response function (out-of-plane displacement vs. input voltage from the function generator) as shown in Figure 6. Table 2 summarized the natural frequency comparison results between analysis and experiment, and the analytic results and the experimental results showed very good agreement (about 3% errors).

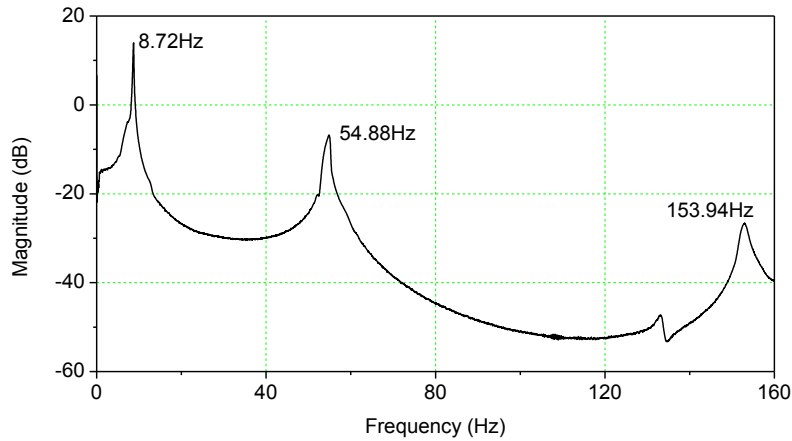

Figure 6: Frequency response function of the aluminum beam structure.

Table 2: Comparison of natural frequencies between analysis and experiment.

Natural frequency (Hz)	Analysis(A)	Experiment(E)	Error=(A-E)/A × 100(%)
1st	9.01	8.72	3.22
2nd	56.45	54.88	2.78
3rd	158.06	153.94	2.61

Piezoelectric paint sensor can only measure in-plane dynamic motions, in terms of vibration measurement, we need to know the relationship between the in-plane motion(strain) and the out-of-plane vibration(displacement). In order to obtain relationship between the strain and the deformation, modal approach was used for construction of displacement-strain transformation(DST) matrix. In other words, DST matrix was constructed using displacement mode shapes and strain mode shapes[7]. The calculation steps of the DST matrix are as follows: If we assume that displacement and strain of structures can be expressed using finite N mode shapes. Then, the displacement and strain are

$$\{d\} = [\Phi_N] \{\eta_N\}, \tag{1}$$

$$\{s\} = [\Psi_N] \{\eta_N\} \tag{2}$$

where $\{d\}$, $[\Phi_N]$, $\{s\}$, $[\Psi_N]$, and $\{\eta_N\}$ represent the displacement, the displacement mode shapes, the strain, the strain mode shapes and the modal coordinates, respectively. Each mode shape was obtained using analytical solution for the beam model.

From Eq. (2), the modal coordinates can be expressed as

$$\{\eta_N\} = ([\Psi_N]^T [\Psi_N])^{-1} [\Psi_N]^T \{s\} \tag{3}$$

Substituting Eq. (3) into Eq. (1), we obtain

$$\{d\} = [\Phi_N][\Psi_N]^T[\Psi_N]^{-1}[\Psi_N]^T\{s\} \tag{4}$$

According to Eq. (4), it is possible to estimate displacement by the multiplication of strain data by DST matrix $([\Phi_N][\Psi_N]^T[\Psi_N]^{-1}[\Psi_N]^T)$. The rank of the DST matrix cannot exceed the number of used strain sensors. It means that we can use as many mode shapes as the number of used sensors at most. Therefore, we must use more sensors if we want to estimate the vibration or deformed shapes accurately at the higher frequency excitation. The piezoelectric paint signal is related to the in-plane strain rate, so that we compared velocity components of the beam vibration in the study. The DST matrix has been constructed by using the analytical strain and displacement mode shapes, and the strain rates have been captured from S1, S3, and S5. For the reference, 3 laser displacement sensors were equipped to measure displacements of the aluminum beam structure mounted on the shaker: one pointed at 0mm; another pointed at 150mm; and the other pointed at 290mm. The overall test setup for vibration monitoring of the beam structure is shown in Figure 7. When vibration occurs on the aluminum beam structure, especially resonant vibration, the output voltages from the piezoelectric paint sensors and displacement from the laser sensors were monitored. Measured output voltages were used to calculate the estimated velocity with DST matrix, then the estimation result was compared with the measured. Figure 8 shows the vibration measurement and estimation results when the shaker excites at the first natural frequency. In addition to the one point measurement, whole structural vibration is also computed and compared with two measurement data as shown in Figure 9.

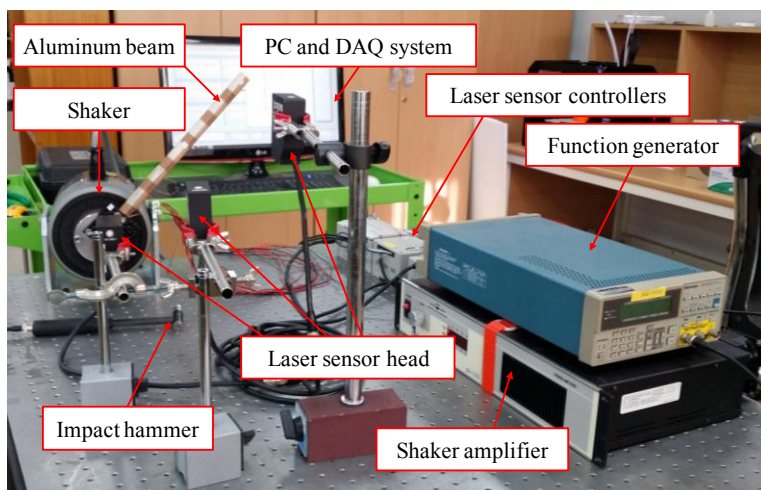

Figure 7: Test setup for vibration monitoring of the beam.

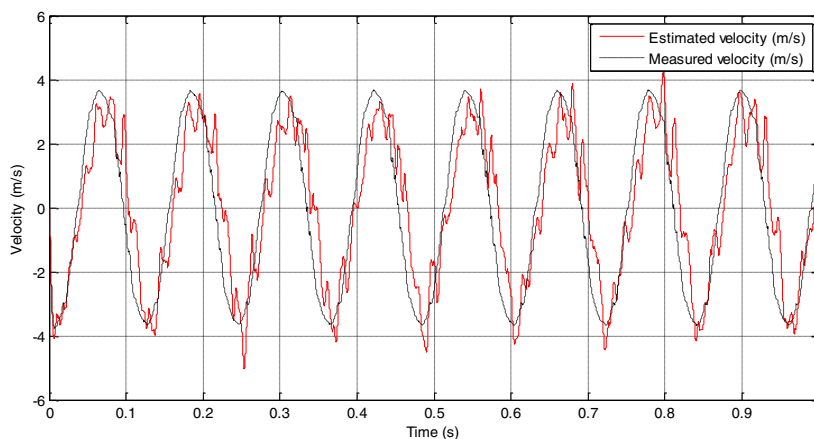

Figure 8: Estimated velocity vs. measured velocity at 290mm.

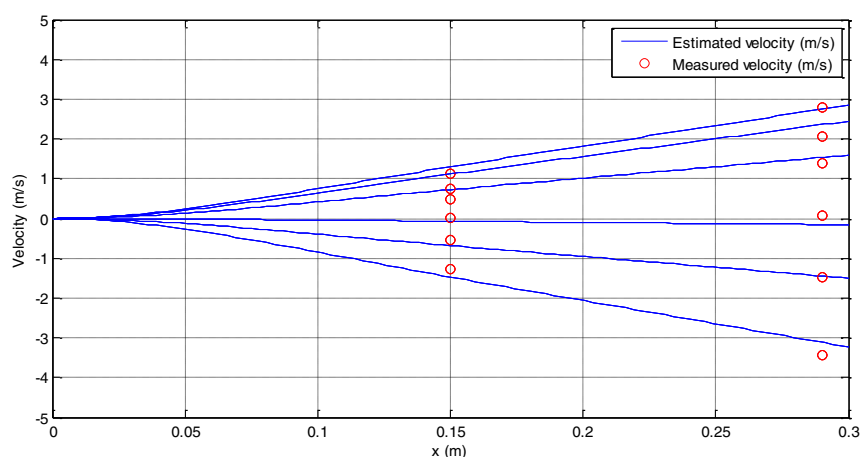

Figure 9: Estimated whole structural vibration with the velocity measured at 150 and 290mm.

CONCLUSION

Piezoelectric paint sensor composed of piezoelectric powder and epoxy resin has been studied for impact and vibration monitoring. In order to make the paint sensor have high sensitivity and easy poling characteristics, PNN-PZT, one of the soft type piezoelectric ceramic, has been used in this study. The poling process was conducted successfully with an electric field of 4kV/mm at room temperature for 30 min. The PNN-PZT/Epoxy paint was coated on the fixed-free aluminum beam structure with 6 electrode parts, and the output voltage were captured when the beam was under several vibration conditions, especially resonant vibration. From 3 piezoelectric paint sensors, the in-plane strain rate signal was obtained and the signal was used to calculate the out-of-plane vibration with DST matrix. The estimation results matches the measured data, and the whole structural vibration can be estimated just using 3 measurement data. In addition to the vibration, impact signal was also monitored using the piezoelectric paint sensors. When the impact hammer hits on the structure, the output voltage from the piezoelectric paint sensors were obtained. The impact monitoring test results showed that the impact force signal over 10N can be captured using the piezoelectric paint sensors.

ACKNOWLEDGEMENT

This research was supported by Leading Foreign Research Institute Recruitment Program through the National Research Foundation of Korea funded by the Ministry of Science, ICT and Future Planning. (2011-0030065)

REFERENCES

- [1] M. Schwartz. *Encyclopedia of Smart Materials*. John Wiley & Sons, Inc., 2002
- [2] J. R. White, B. de Poumeyrol, J. M. Hale and R. Stephenson. Piezoelectric Paint: Ceramic-polymer Composites for Vibration Sensors. *Journal of Materials Science*, 39(9):3105-3114, 2004.
- [3] I. Payo, J. M. Hale. Dynamic Characterization of Piezoelectric Paint Sensors under Biaxial Strain. *Sensors and Actuators A: Physical*, 163(1):150-158, 2010.
- [4] Y. Zhang. In Situ Fatigue Crack Detection using Piezoelectric Paint Sensor. *Journal of Intelligent Material and Structures*, 17(10):843-852, 2006.
- [5] J. Qiu, J. Tani, N. Yanada, Y. Kobayashi, and H. Takahashi. Fabrication of $\text{Pb}(\text{Nb},\text{Ni})\text{O}_3\text{-Pb}(\text{Zr},\text{Ti})\text{O}_3$ Piezoelectric Ceramic Fibers by Extrusion of a Sol-powder Mixture. *Journal of Intelligent Material Systems and Structures*, 15(8):643-653, 2004.

- [6] M.-W. Lee, S.-J. Kim, M.-S. Yoon, S.-L. Ryu, and S.-Y. Kweon. Low Temperature Sintering of PNN-PZT Ceramics and Its Electrical Properties, *Journal of the Korean Institute of Electrical and Electronic Material Engineers*, 21(12):1077-1082, 2008.
- [7] L.-H. Kang, D.-K. Kim, J.-H. Han. Estimation of Dynamic Structural Displacements Using Fiber Bragg Grating Strain Sensors. *Journal of Sound and Vibration*, 305:534–542, 2007.