



HAL
open science

Structure and forces in stressed 3D packings

Nicolas Brodu, Joshua Dijksman, Robert Behringer

► **To cite this version:**

Nicolas Brodu, Joshua Dijksman, Robert Behringer. Structure and forces in stressed 3D packings. DDS 2014 - Driven Disordered Systems, Jun 2014, Grenoble, France. hal-01016902

HAL Id: hal-01016902

<https://inria.hal.science/hal-01016902>

Submitted on 4 Oct 2014

HAL is a multi-disciplinary open access archive for the deposit and dissemination of scientific research documents, whether they are published or not. The documents may come from teaching and research institutions in France or abroad, or from public or private research centers.

L'archive ouverte pluridisciplinaire **HAL**, est destinée au dépôt et à la diffusion de documents scientifiques de niveau recherche, publiés ou non, émanant des établissements d'enseignement et de recherche français ou étrangers, des laboratoires publics ou privés.

STRUCTURE AND FORCES IN STRESSED 3D PACKINGS

Nicolas Brodu^{1,2}, Joshua Dijksman¹, Robert Behringer¹

¹ Department of Physics, Duke University

² Geostat team, INRIA Bordeaux

Gdr Phenix, Driven Disordered Systems meeting June 2014

RATIONALE / WHY

Mechanical stresses on granular assemblies are ubiquitous

- Repeated compression
(e.g. trucks passing on a road)
- Shearing
(e.g. gravitational pull on a mountain slope)
- Industrial processes, civil engineering, environment...

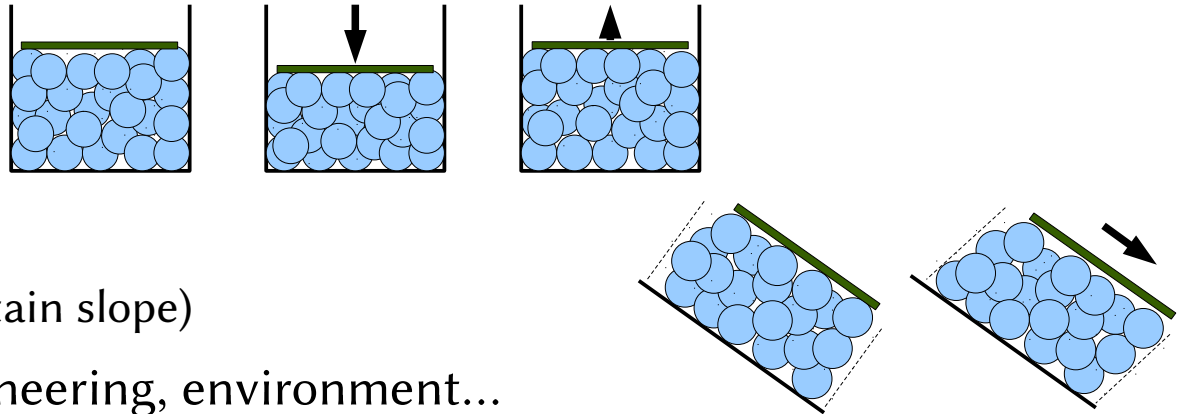

Understanding their macroscopic response is necessary

- Requires “seeing” what is the state at the level of grains

Most studies are 2D. Most real cases are 3D.

This work = structure + forces in 3D

ACCESSING THE MICRO-STRUCTURE

X-rays / micro-ct

Fine resolution

Most materials

Costly

Confocal: emulsions

Microscopic

Costly

Difficult to control applied stresses

This work: refractive index matching

Macroscopic grains

Easy to control, tri-axial shearing

Cheap

Submersed

Next slides on:

1. Structure
2. Forces in 3D

Mukhopadhyay *et al.*
Phys. Rev. E 84, 011302, 2011

Dijksman *et al.*
Rev. Sci. Instrum. 2012

Hydrogel grains
index-matched
+ fluorescent dye

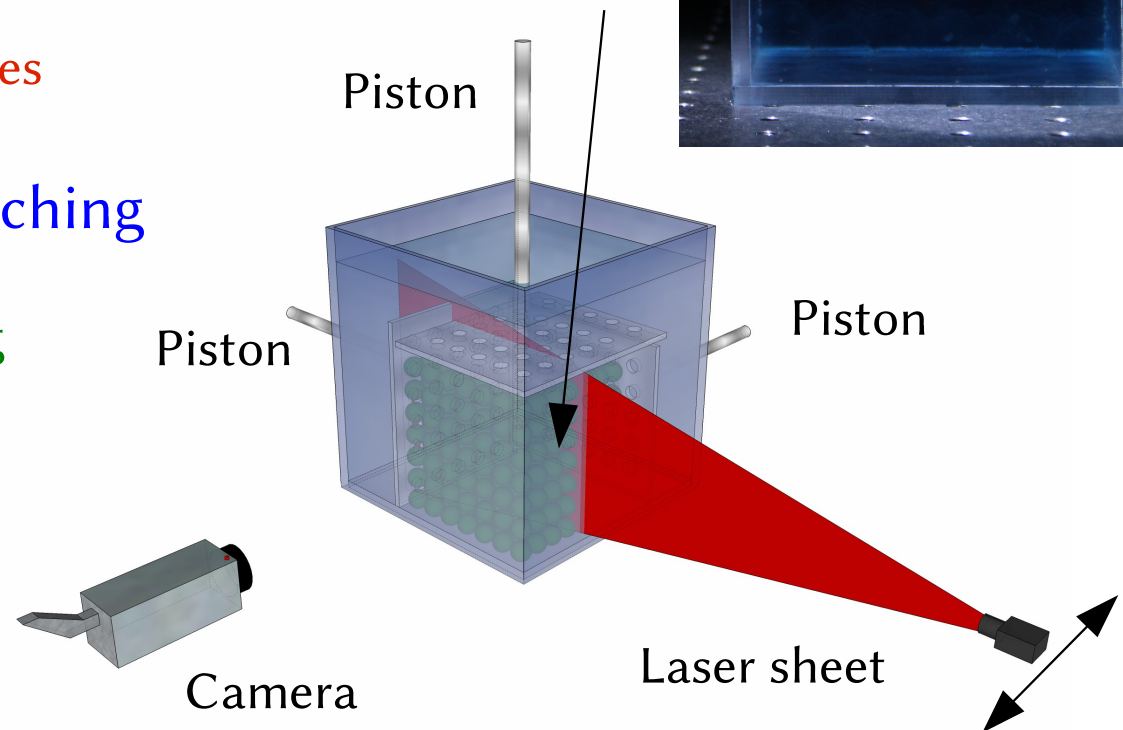
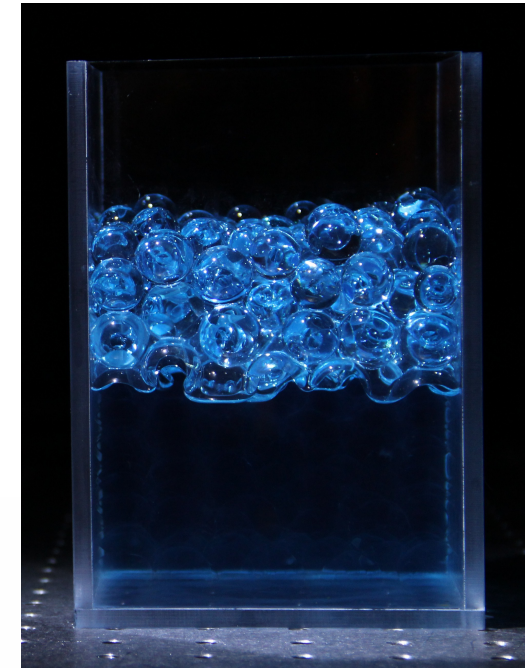

WHAT WE GET

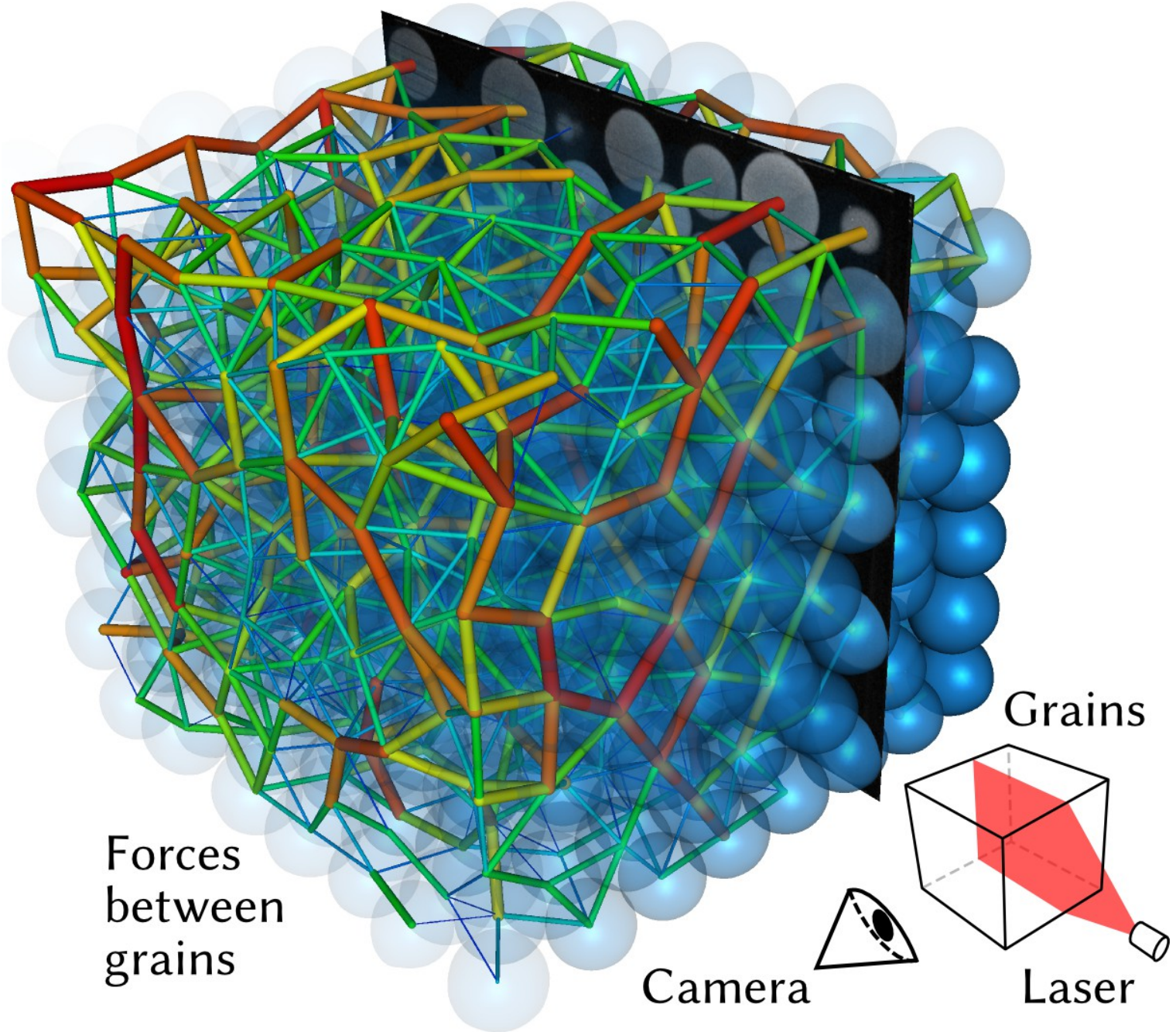

TYPICAL IMAGE

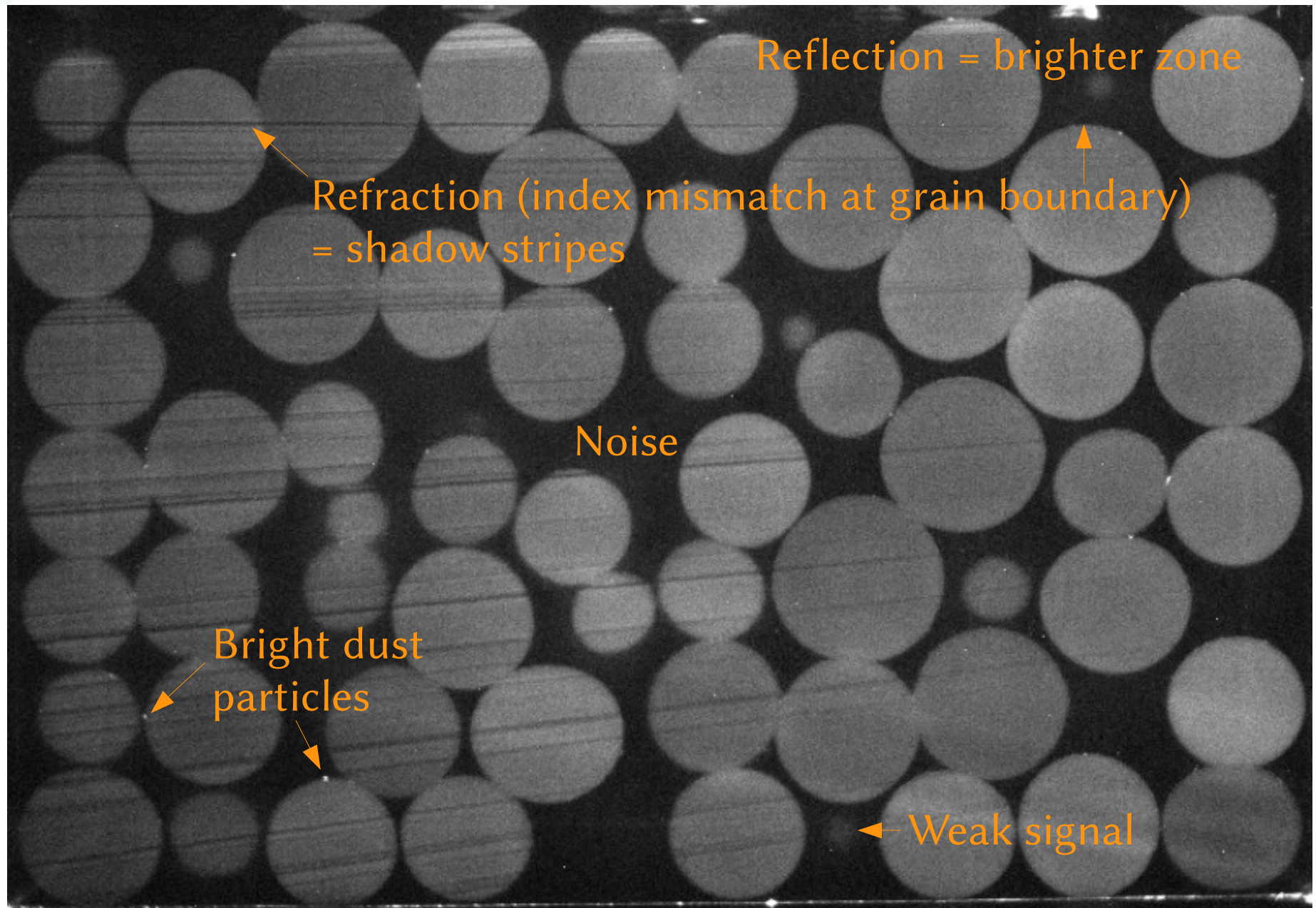
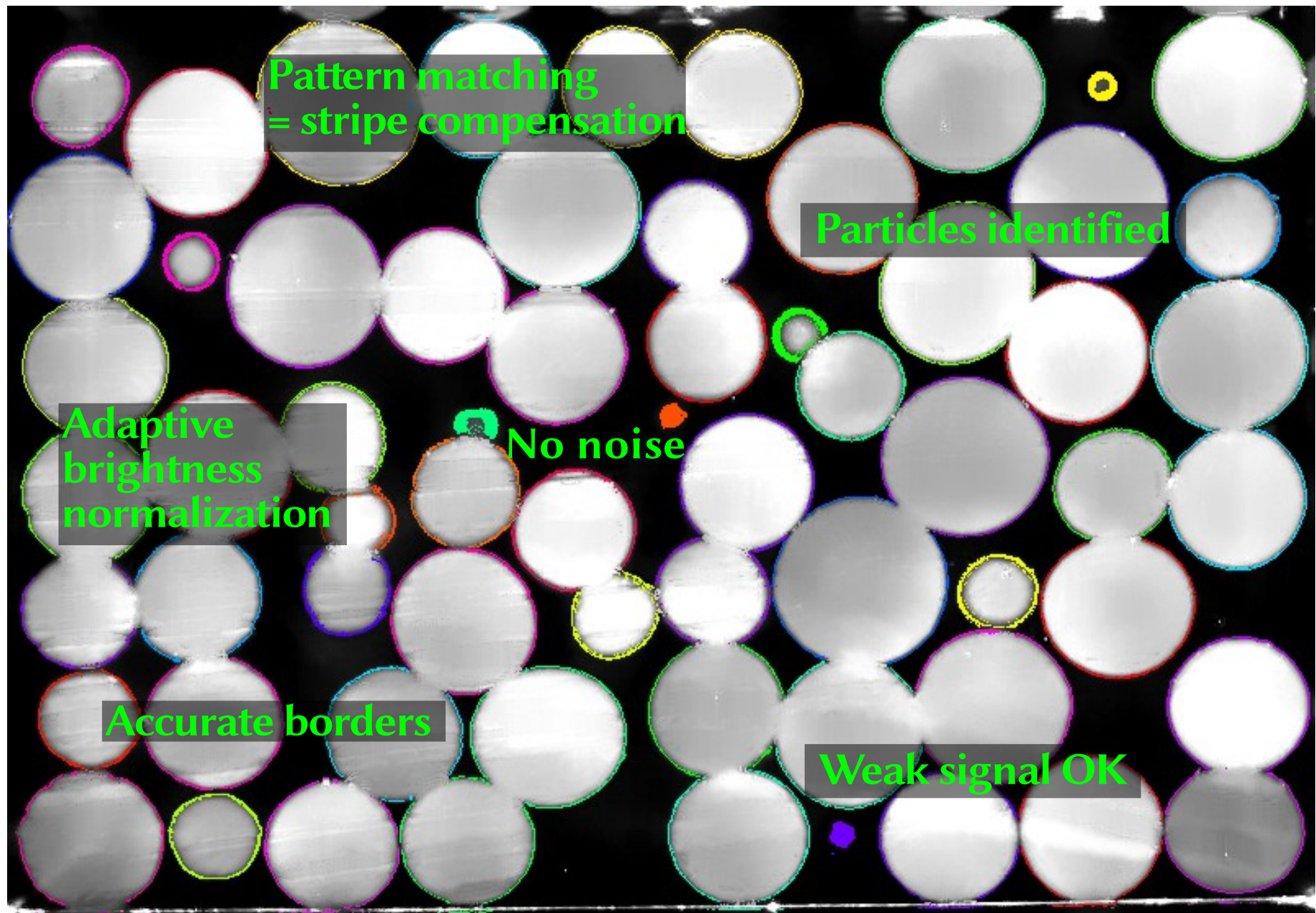

IMAGE PROCESSING



FROM 2D IMAGES TO 3D GRAINS

Step 1: Stack the images into 3D voxel

Step 2: Detect border voxels

Step 3: Fit an analytic surface to these borders

Done here using a spline basis of functions on the unit sphere

Step 4: Use these surfaces to get accurate forces

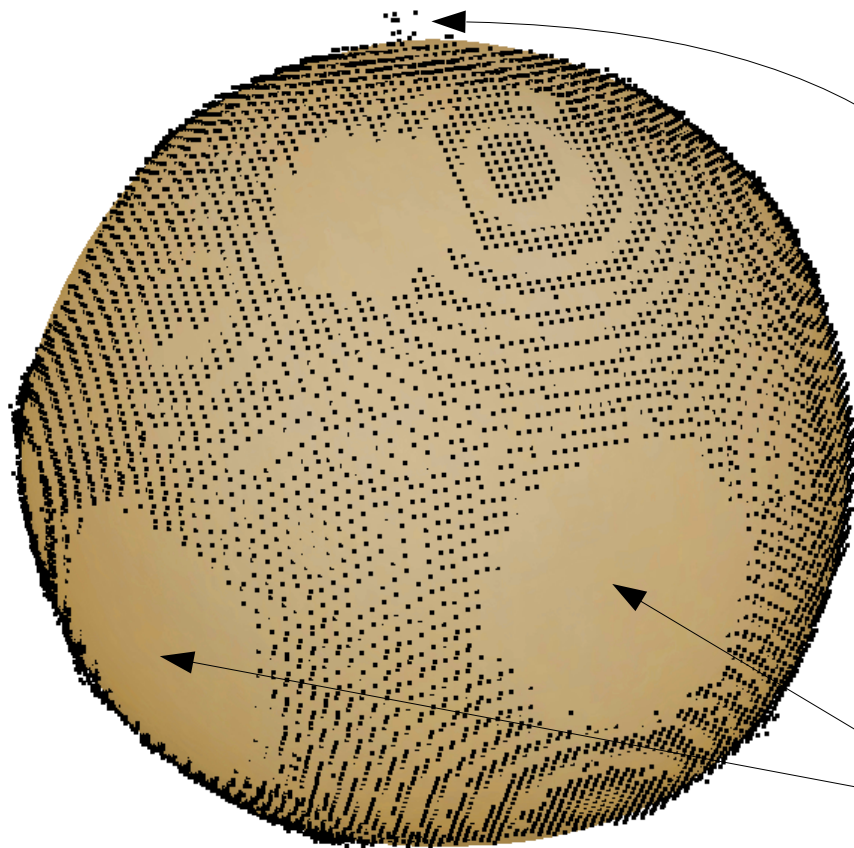

Outliers completely eliminated

Contacts = no border between grains
BUT surface area is well defined

INFERRING FORCES IN FULL 3D

Analytic shape descriptions \Rightarrow contact properties

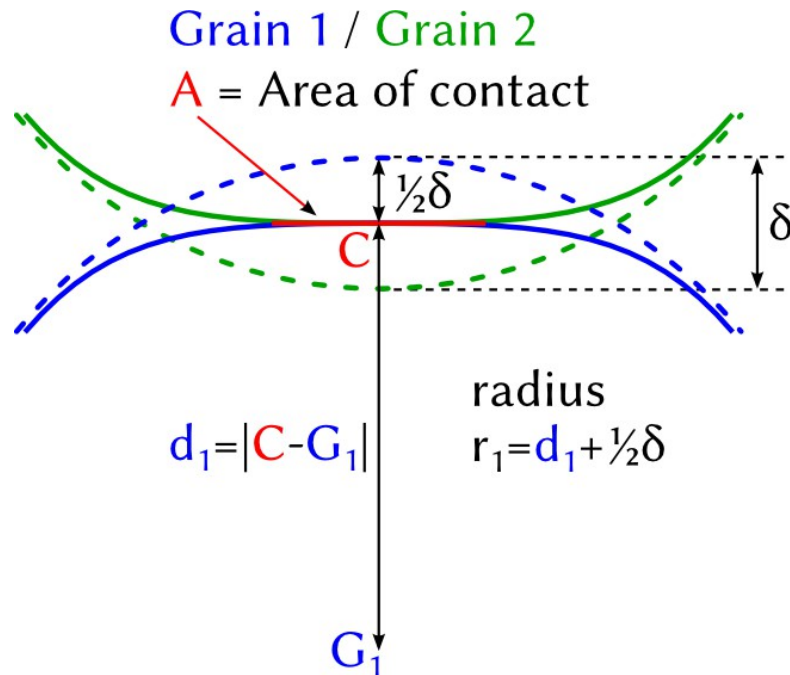

Measured here: A, C, G_1, G_2, d_1, d_2 .
 Unknown: δ

Contact properties \Rightarrow forces

$$\frac{1}{r} = \frac{1}{r_1} + \frac{1}{r_2} \quad \text{radius of curvature at contact}$$

$$F = E r^{1/2} \delta^{3/2} \quad E = \text{effective Young modulus}$$

$$F = E \delta a \quad a = \sqrt{A/\pi} \quad \text{radius of the contact}$$

$$\text{Hence } r \delta = A/\pi \Rightarrow \delta \Rightarrow F \quad (\text{with given } E)$$

\Rightarrow Vector forces in full 3D, with orientation, position, norm
 + grain centers of mass, stress tensor, etc.

10 UNI-AXIAL COMPRESSION CYCLES

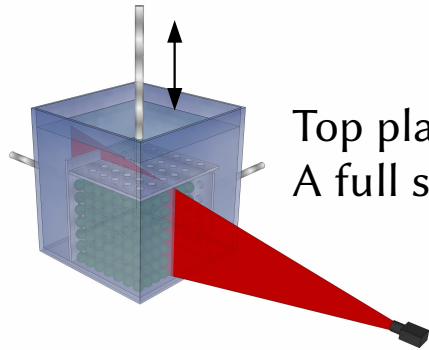
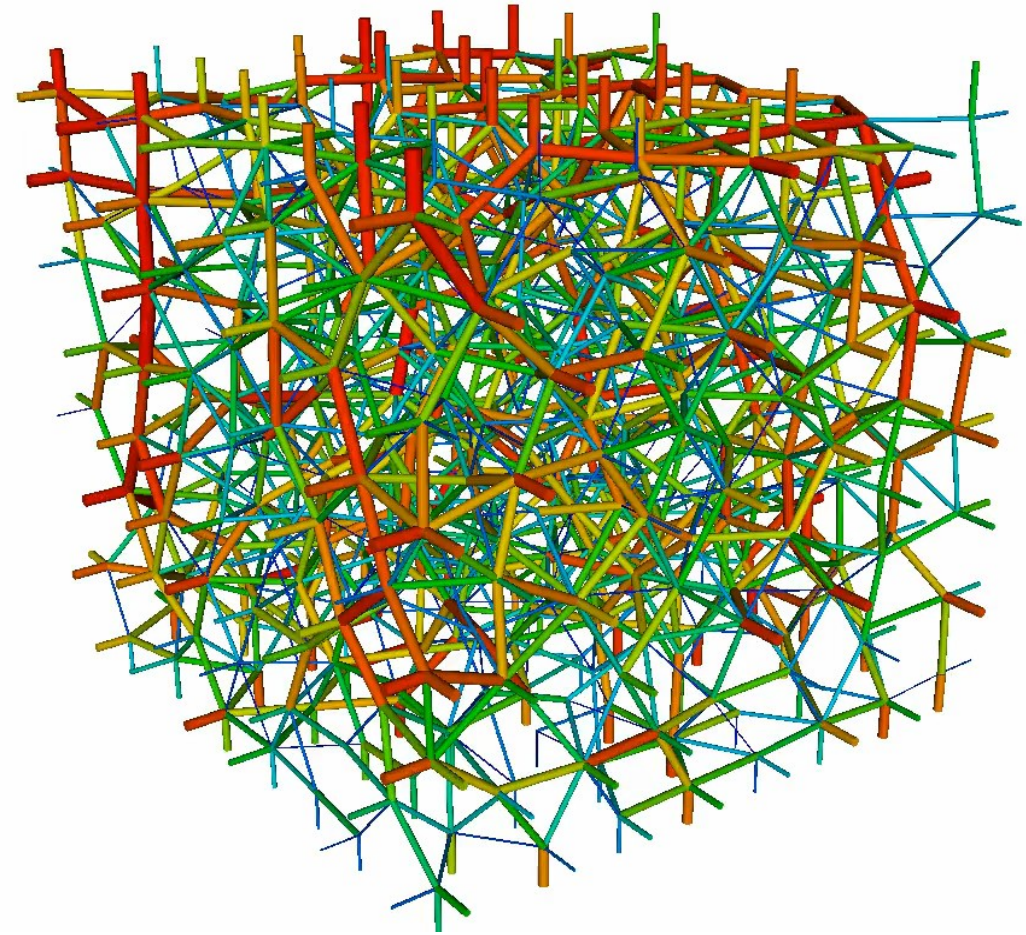
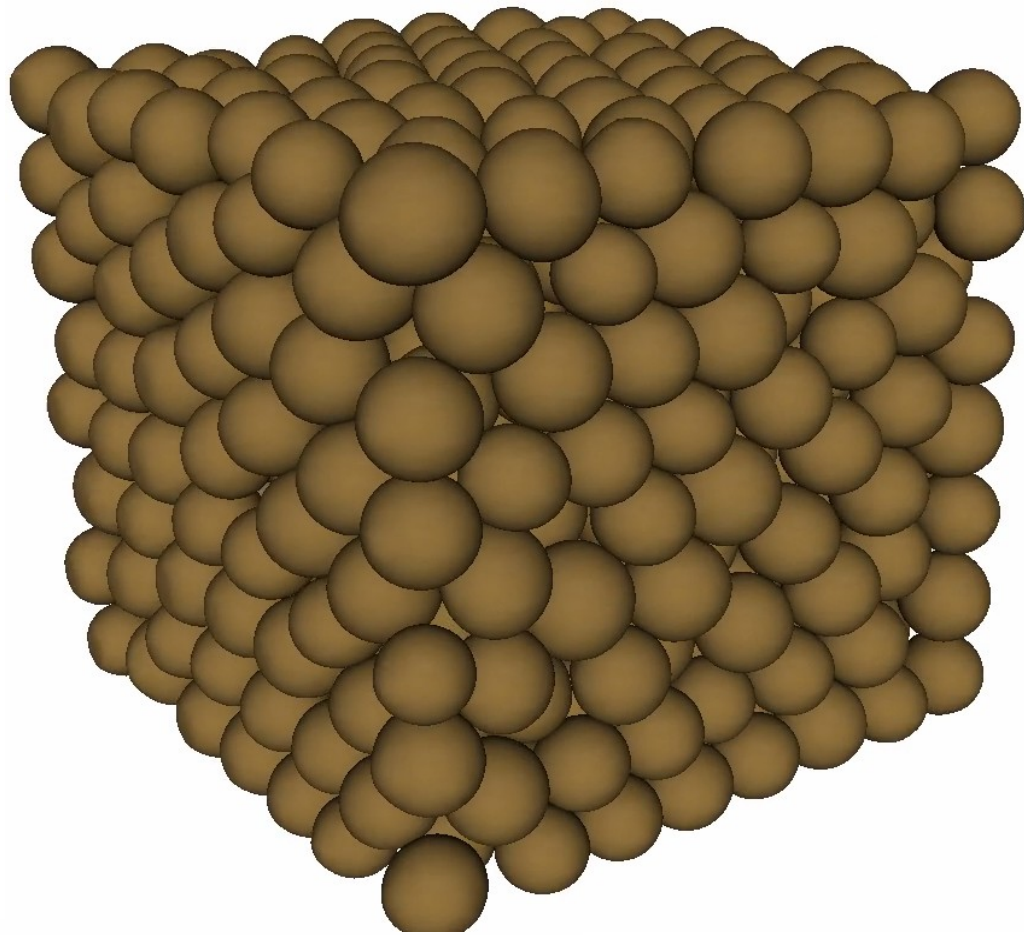

Top plate moves by 1mm increments
A full scan is taken between increments

Forces = struts joining the grain centers
Blue = weakest, Red = strongest

VALIDATION ON COMPRESSION CYCLES

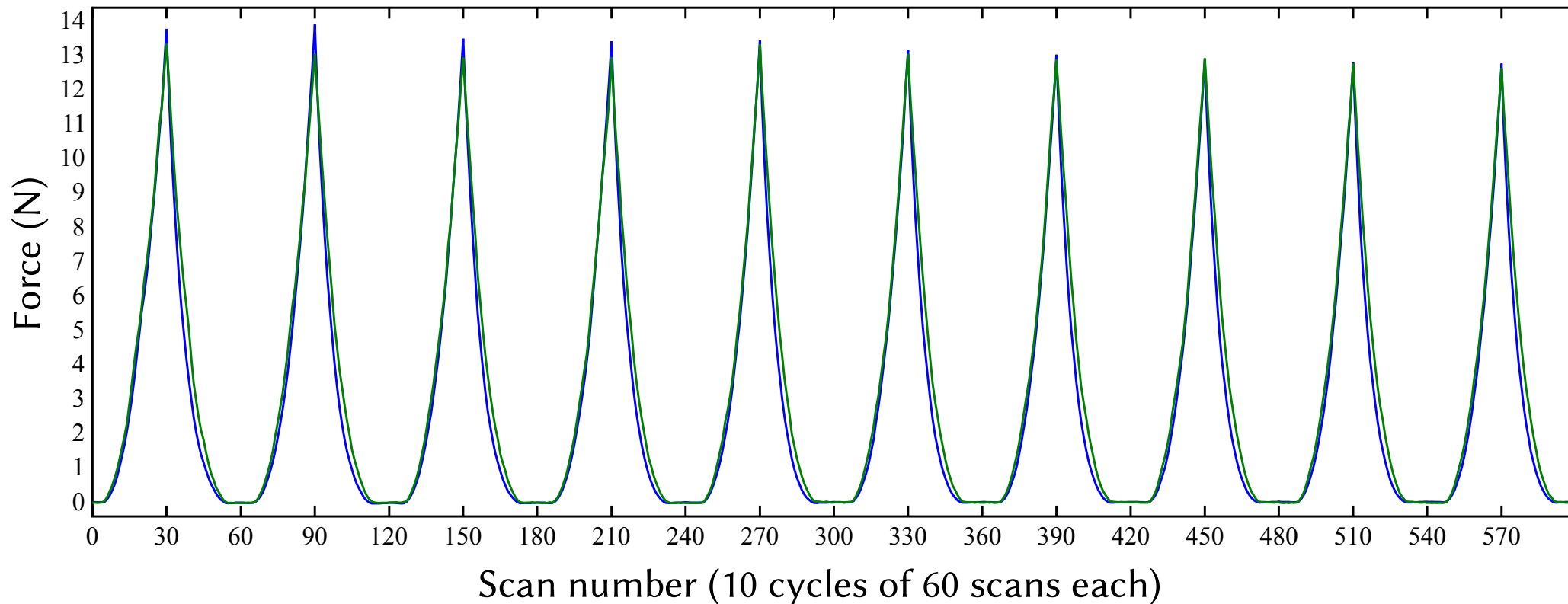

Blue = force measured on the top plate sensor

Green = force inferred from the images + measure of $E=22.4$ kPa

Grain deformation up to $\approx 13\%$, scan processed independently: no global fitting
 $\approx 980 \cdot 10^3$ contacts over 600 scans. Resolution $\approx 10^{-2}$ N.

NUMBER OF CONTACTS PER GRAIN Z

Number of contacts per grain (Z)

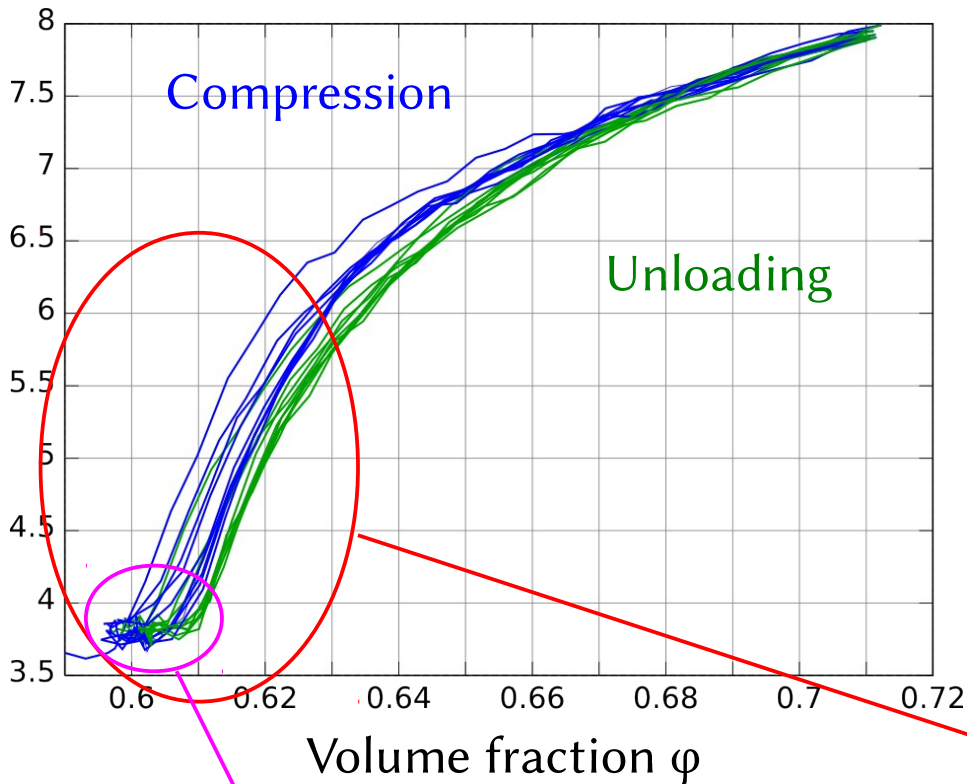

The top plate does not touch the grains
= ignored scans

$p(Z)$

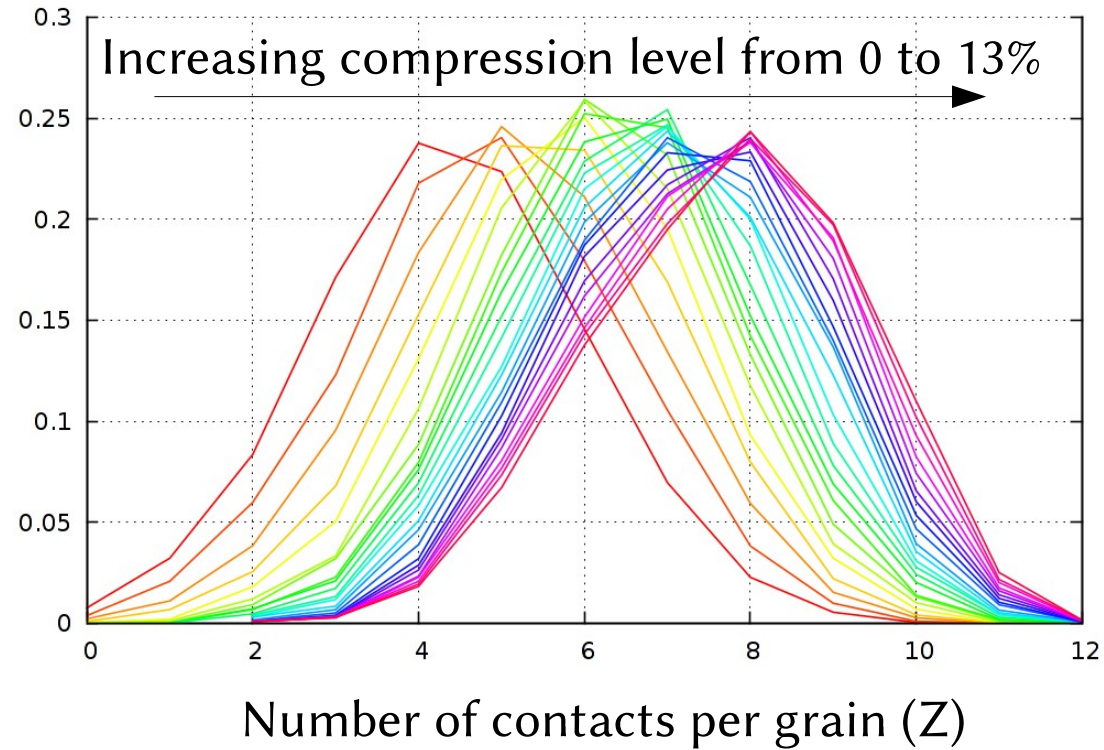

Weak contacts are missing and below the experiment resolution!

NON-HERTZIAN PACKING RESPONSE

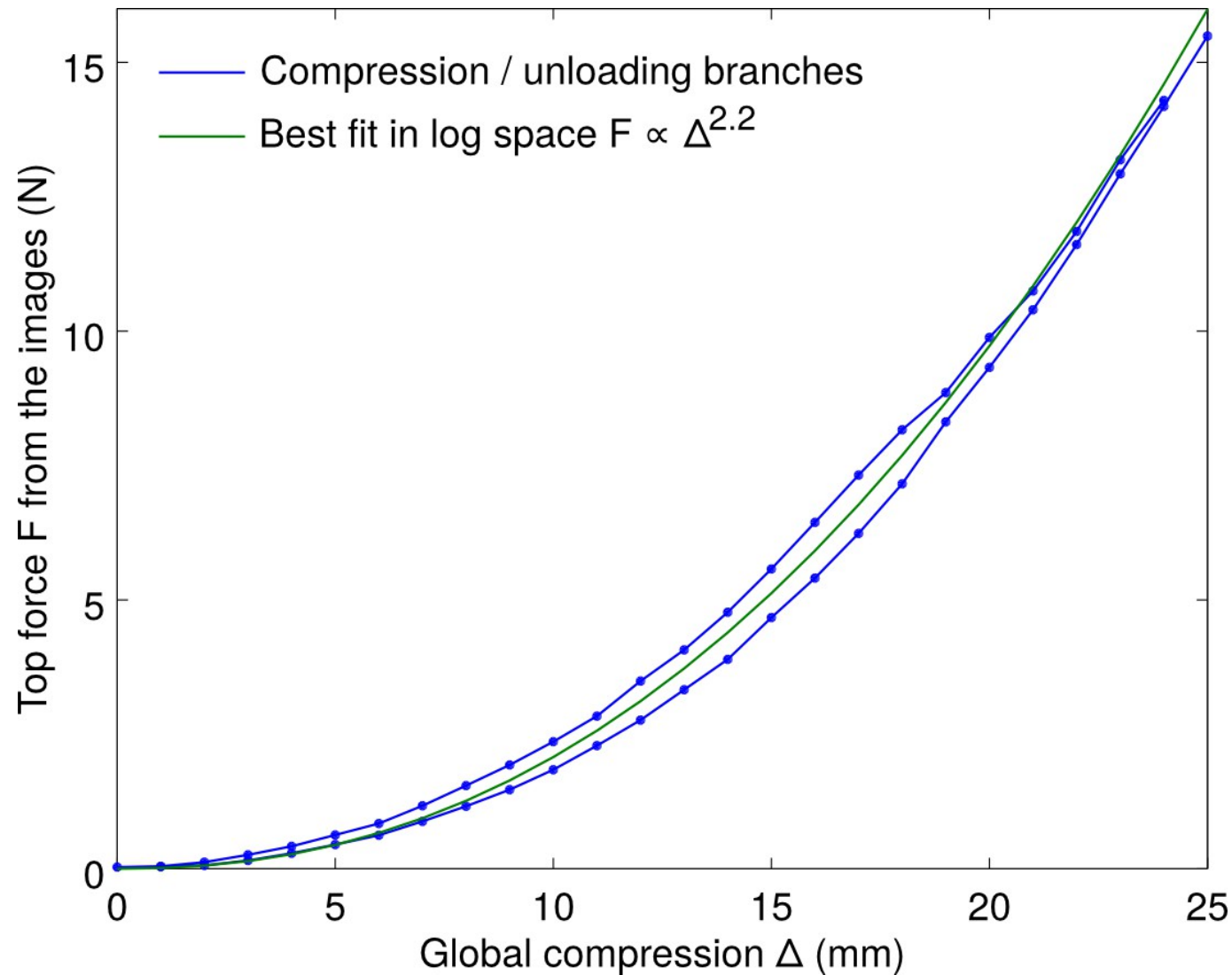

A SCALING HOLDS, WHICH IS ...

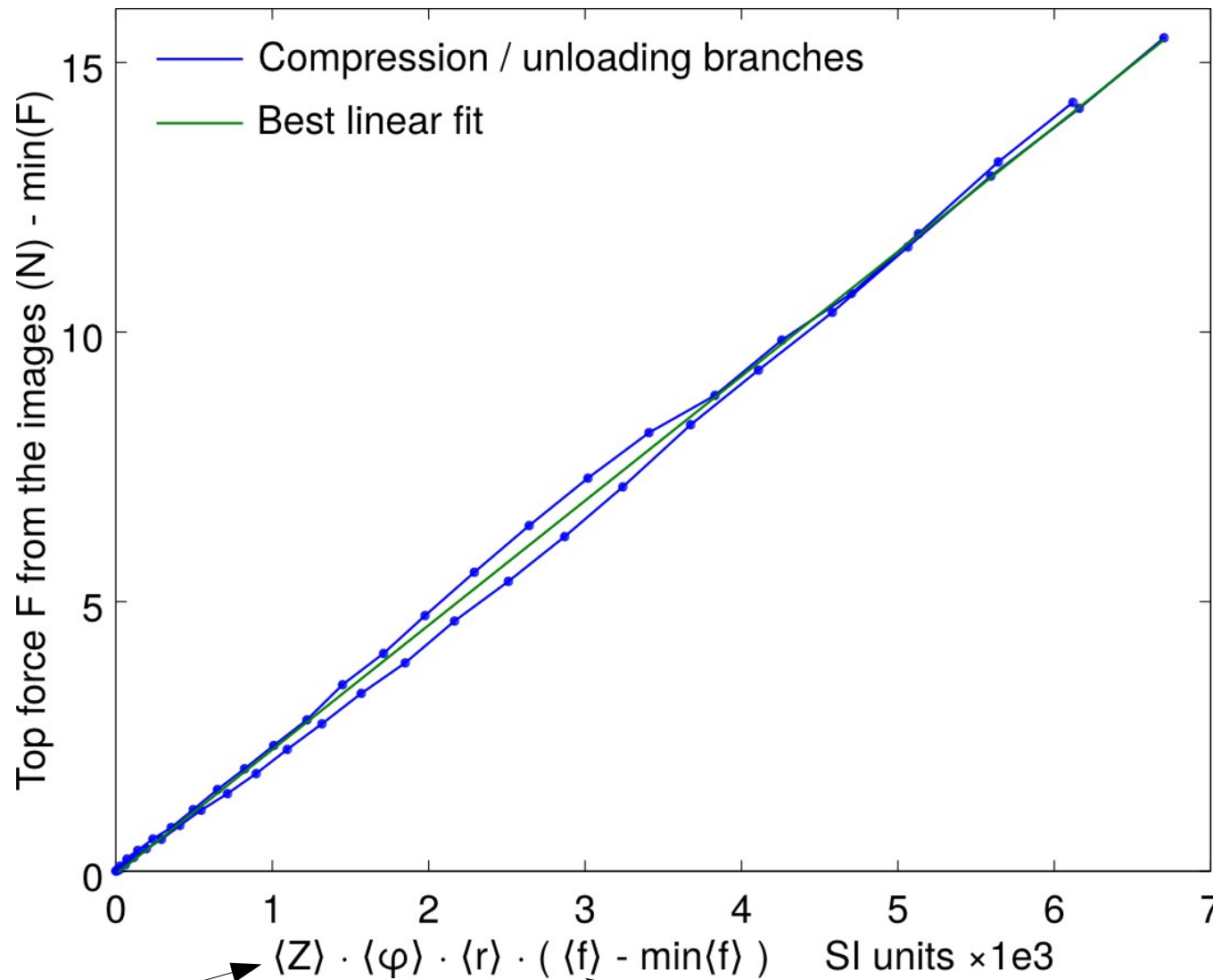

#contacts / grain

volume fraction

radius

force at contacts

... A MEAN STRESS TENSOR

A mean $\langle Z \rangle$ in the relation \Rightarrow some kind of isotropy between contacts

\Rightarrow Use the isotropic pressure $p = \frac{1}{3} \text{tr} S$ with S the stress tensor.

Without hydrostatic gradient (density match), the force on the top plate $F = p \cdot L \cdot W$

For a given volume element V_e : $S = \frac{1}{V_e} \sum_{c \in V_e} \mathbf{b} \otimes \mathbf{f}_c$

With \mathbf{b} linking the grain centers and \mathbf{f}_c the force vector at contact c .

Sphere approximation: the trace is simply the dot product: $\text{tr} \mathbf{b} \otimes \mathbf{f}_c = \mathbf{b} \cdot \mathbf{f}_c$
and also $\langle \mathbf{b} \rangle = 2 \langle r \rangle$, with r = distance from center to contact for spheres.

The number of terms in the sum depends on the density of contacts v . Incompressible grains \Rightarrow avg. volume $\langle V \rangle$ is constant. With φ the grain volume fraction: $v = \frac{1}{2} Z \varphi / \langle V \rangle$

Replacing these terms by their averages over all contacts $\Rightarrow F \propto \langle Z \rangle \langle \varphi \rangle \langle r \rangle \langle f \rangle$

Note: subtracting min F and min $\langle f \rangle$ on both sides
in noisy experimental data for consistency with $f=0 \Rightarrow F=0$

DEMO + QUESTIONS