



HAL
open science

Gray codes avoiding matchings

Darko Dimitrov, Tomáš Dvořák, Petr Gregor, Riste Škrekovski

► **To cite this version:**

Darko Dimitrov, Tomáš Dvořák, Petr Gregor, Riste Škrekovski. Gray codes avoiding matchings. Discrete Mathematics and Theoretical Computer Science, 2009, Vol. 11 no. 2 (2), pp.123–147. 10.46298/dmtcs.457 . hal-00988206

HAL Id: hal-00988206

<https://inria.hal.science/hal-00988206>

Submitted on 7 May 2014

HAL is a multi-disciplinary open access archive for the deposit and dissemination of scientific research documents, whether they are published or not. The documents may come from teaching and research institutions in France or abroad, or from public or private research centers.

L'archive ouverte pluridisciplinaire **HAL**, est destinée au dépôt et à la diffusion de documents scientifiques de niveau recherche, publiés ou non, émanant des établissements d'enseignement et de recherche français ou étrangers, des laboratoires publics ou privés.

Gray Codes Avoiding Matchings[†]

Darko Dimitrov¹, Tomáš Dvořák², Petr Gregor^{2,‡} and Riste Škrekovski^{3,§}

¹*Institut für Informatik, Freie Universität Berlin, Takustraße 9, 14195 Berlin, Germany.*

²*Faculty of Mathematics and Physics, Charles University, Malostranské nám. 25, 11800 Praha, Czech Republic.*

³*Department of Mathematics, University of Ljubljana, Jadranska 19, 1111 Ljubljana, Slovenia.*

A (cyclic) n -bit Gray code is a (cyclic) ordering of all 2^n binary strings of length n such that consecutive strings differ in a single bit. Equivalently, an n -bit Gray code can be viewed as a Hamiltonian path of the n -dimensional hypercube Q_n , and a cyclic Gray code as a Hamiltonian cycle of Q_n . In this paper we study (cyclic) Gray codes avoiding a given set of faulty edges that form a matching. Given a matching M and two vertices u, v of Q_n , $n \geq 4$, our main result provides a necessary and sufficient condition, expressed in terms of forbidden configurations for M , for the existence of a Gray code between u and v that avoids M . As a corollary, we obtain a similar characterization for a cyclic Gray code avoiding M . In particular, in the case that M is a perfect matching, Q_n has a (cyclic) Gray code that avoids M if and only if $Q_n - M$ is a connected graph. This complements a recent result of Fink, who proved that every perfect matching of Q_n can be extended to a Hamiltonian cycle. Furthermore, our results imply that the problem of Hamiltonicity of Q_n with faulty edges, which is NP-complete in general, becomes polynomial for up to 2^{n-1} edges provided they form a matching.

Keywords: Gray code, hypercube, Hamiltonian path, Hamiltonian cycle, matching, fault tolerance

1 Introduction

A (cyclic) n -bit Gray code is a (cyclic) ordering of all 2^n binary strings of length n such that consecutive strings differ in a single bit. It is named after Frank Gray, who in 1953 patented a simple scheme to generate such a cyclic code for every $n \geq 2$ [7]. Since then, the research on Gray codes satisfying certain additional properties has received a considerable attention, and applications have been found in such diverse areas as data compression, graphics and image processing, information retrieval, signal encoding or processor allocation in hypercubic networks [13].

Alternatively, an n -bit Gray code can be viewed as a Hamiltonian path of the n -dimensional hypercube Q_n , and a cyclic Gray code as a Hamiltonian cycle of Q_n . The applications of hypercubes in parallel computing [10] inspired the investigation of Hamiltonian paths and cycles in hypercubes avoiding a given set of faulty edges. Chan and Lee [2] proved that the problem whether Q_n contains a Hamiltonian cycle avoiding a given set \mathcal{F} of faulty edges is NP-complete. On the other hand, they showed that if $|\mathcal{F}| \leq$

[†]Partially supported by the Czech-Slovenian bilateral grant MEB 090805.

[‡]Corresponding author, gregor@ktiml.mff.cuni.cz. Partially supported by the Czech Science Foundation Grant 201/08/P298.

[§]The work of this author was partially supported by Slovenian ARRS Research Grant P1-0297.

$2n - 5$, $n \geq 3$, then such a Hamiltonian cycle exists if and only if each vertex is incident with at least two nonfaulty edges. This upper bound is sharp in the sense that for any $n \geq 3$ there are $2n - 4$ faulty edges in Q_n satisfying the above condition, but there is no Hamiltonian cycle avoiding them. Tsai [14] obtained a similar result for Hamiltonian paths with given endvertices.

A related problem considers Hamiltonian cycles and paths in hypercubes passing through a set of prescribed edges. Caha and Koubek [1] observed that if a set \mathcal{P} of prescribed edges extends to a Hamiltonian cycle, then it induces a subgraph consisting of pairwise vertex-disjoint paths. On the other hand, they showed that for any $n \geq 3$ there is a set of $2n - 2$ edges, satisfying this necessary condition, but there is no Hamiltonian cycle of Q_n containing them. This bound is sharp in the sense that $|\mathcal{P}| \leq 2n - 3$, $n \geq 2$, the necessary condition is also sufficient for a Hamiltonian cycle of Q_n passing through every edge of \mathcal{P} [3]. There is a similar result for Hamiltonian paths with prescribed endvertices if $|\mathcal{P}| \leq 2n - 4$, $n \geq 5$ [4]. A special case of the above problem, posed by Ruskey and Savage [12], is when the prescribed edges comprise a matching of the hypercube. Kreweras [9] conjectured that every perfect matching of Q_n , $n \geq 2$, can be completed to a Hamiltonian cycle. Recently, the conjecture was proved by Fink [5].

In this paper we study (cyclic) Gray codes avoiding a given set of faulty edges that form a matching. Given a matching M and two vertices u, v of Q_n , $n \geq 4$, our main result provides a necessary and sufficient condition for the existence of a Gray code between u and v that avoids M . As a corollary, we obtain a similar characterization for the existence of a cyclic Gray code avoiding M . In particular, in the case that M is a perfect matching, Q_n has a (cyclic) Gray code that avoids M if and only if $Q_n - M$ is a connected graph.

Note that this complements the above quoted result of Fink. Furthermore, since our necessary and sufficient conditions are decidable in a polynomial time, our results imply that the problem of Hamiltonicity of Q_n with faulty edges, which is NP-complete in general, becomes polynomial for up to 2^{n-1} edges provided they form a matching.

After definitions and preliminary results in the next two sections, we study necessary conditions in Sections 4 and 5. The induction step of our construction is presented in Section 6, while the obtained results are summarized in Section 7. The study of initial cases $n = 3$ and $n = 4$, which involves a rather elaborate case analysis, can be found in Appendix A and B.

2 Preliminaries

In this text n is always a positive integer and $[n]$ denotes the set $\{1, 2, \dots, n\}$. As usual, the vertex and edge sets of a graph G are denoted by $V(G)$ and $E(G)$, respectively. For a vertex $v \in V(G)$ and a set $E \subseteq E(G)$, let $G - v$ denote the subgraph of G induced by $V(G) \setminus \{v\}$, and let $G - E$ denote the graph with vertices $V(G)$ and edges $E(G) \setminus E$. Similarly, for a pair of vertices $x, y \in V(G)$ let $G + xy$ denote the graph with vertices $V(G)$ and edges $E(G) \cup \{xy\}$. The distance of vertices u and v is denoted by $d(u, v)$. The distance $d(u, vw)$ of a vertex u and an edge vw is defined as the minimum of distances $d(u, v)$ and $d(u, w)$.

A *path between a and b* , denoted by P_{ab} , is a graph consisting of pairwise distinct vertices $a = x_1, x_2, \dots, x_n = b$ and edges $x_i x_{i+1}$ for all $i \in [n - 1]$. Note that if $a = b$, then $n = 1$ and we obtain the trivial path P_{aa} consisting of a single vertex a . If P_{ab} and P_{cd} are vertex disjoint paths and b and c are adjacent vertices, then $P_{ab} + P_{cd}$ denotes the path between a and d , obtained as a concatenation of P_{ab} with P_{cd} . A path P is called a *subpath* of a path P' if P forms a subgraph of P' . We say that paths $\{P_i\}_{i=1}^n$ are *spanning paths* of a graph G if $\{V(P_i)\}_{i=1}^n$ partitions $V(G)$.

The n -dimensional hypercube Q_n is the graph with vertex set $V(Q_n) = \{0, 1\}^n$ and edge set $E(Q_n) = \{uv \mid |\Delta(u, v)| = 1\}$ where $\Delta(u, v) = \{i \in [n] \mid u_i \neq v_i\}$. The *dimension* $\dim(uv)$ of an edge $uv \in E(Q_n)$ is the integer d such that $\Delta(u, v) = \{d\}$. For a vertex $v \in V(Q_n)$ let v^d denote the vertex of Q_n such that vv^d is an edge of dimension d .

All edges of the same dimension d form a *layer (of dimension d)* in Q_n . Note that $E(Q_n)$ is partitioned into n layers, each of size 2^{n-1} . Moreover, for every $d \in \Delta(u, v)$, each path P_{uv} contains an edge of dimension d . In other words, vertices u and v are separated by the layer of dimension d .

The *parity* $p(v)$ of a vertex $v \in V(Q_n)$ is defined by $p(v) = \|v\| \bmod 2$ where $\|v\| = \sum_{i=1}^n v_i$. Note that vertices of each parity form bipartite sets of Q_n . Consequently, $p(u) = p(v)$ if and only if $d(u, v)$ is even. We extend the definition of the parity to edges by putting for $uv \in E(Q_n)$

$$p(uv) = \begin{cases} p(u), & \text{if } \|u\| < \|v\|; \\ p(v), & \text{otherwise.} \end{cases}$$

For every $d \in [n]$ let Q_L^d and Q_R^d denote the subgraphs of Q_n induced by the sets $\{v \in V(Q_n) \mid v_d = 0\}$ and $\{v \in V(Q_n) \mid v_d = 1\}$, respectively. The symbols L and R stand for ‘left’ and ‘right’, which corresponds to the presentation of Q_L and Q_R in our figures. Note that both Q_L^d and Q_R^d are isomorphic to Q_{n-1} . Similarly, for a matching M in Q_n put

$$\begin{aligned} M^d &= \{e \in M \mid \dim(e) = d\}, \\ M_L^d &= M \cap E(Q_L^d), \text{ and} \\ M_R^d &= M \cap E(Q_R^d). \end{aligned}$$

Observe that $(Q_i^a)_j^b = (Q_j^b)_i^a$ and $(M_i^a)_j^b = (M_j^b)_i^a$ for every $a, b \in [n]$ and $i, j \in \{L, R\}$.

Given a set F of faulty edges of Q_n , we say that a subgraph of Q_n *avoids* F if it forms a subgraph of $Q_n - F$.

3 Some fundamental results

A classical result of Lewinter and Widulski [11] describes Hamiltonian paths in hypercubes with one faulty vertex.

Lemma 1 *For any pairwise distinct vertices u, v, w in Q_n such that $p(u) = p(v) \neq p(w)$, there exists a Hamiltonian path of $Q_n - w$ between u and v .*

There is a similar characterization for hypercubes with at most one faulty edge, which follows from more general results of Tsai et al. [15]. It should be remarked that the special case of $M = \emptyset$ was firstly observed by Havel [8].

Lemma 2 *For every $n \geq 3$, vertices u and v of different parities, and a matching M of Q_n with $|M| \leq 1$, there exists a Hamiltonian path in $Q_n - M$ between u and v .*

An extension of the above mentioned Havel’s result was obtained in [3].

Lemma 3 *For every distinct vertices u, v, x, y of Q_n such that $p(u) \neq p(v)$ and $p(x) \neq p(y)$, there exist spanning paths P_{uv}, P_{xy} of Q_n .*

We shall also employ the following lemma on the existence of a Hamiltonian path passing through a prescribed edge, which is a special case of more general results of Caha and Koubek [1].

Lemma 4 For every two vertices u, v and an edge e of Q_n such that $p(u) \neq p(v)$ and $e \neq uv$, there exists a Hamiltonian path of Q_n between u and v passing through e .

We conclude this section with a simple observation.

Proposition 1 For every matching M in Q_n with $|M| = 2$ there exists a dimension $d \in [n]$ such that $|M_L^d| = |M_R^d| = 1$.

Proof: We argue by induction on n . Since the case $n \leq 2$ is obvious, assume that $n \geq 3$ and choose an arbitrary $d \in [n] \setminus \{\dim(e) \mid e \in M\}$. If $|M_L^d| = |M_R^d| = 1$, we are done. Otherwise it must be the case that $M = M_i^d$ for some $i \in \{L, R\}$ and hence by the induction hypothesis, there exists $d' \in [n] \setminus \{d\}$ such that $|M_L^{d'}| = |(M_i^d)^{d'}| = 1 = |(M_i^d)^{d'}| = |M_R^{d'}|$ as required. \square

4 Half-layers

A matching M in Q_n , $n \geq 2$, is called a *half-layer* in Q_n if M consists exactly of all edges of dimension d and parity p for some $d \in [n]$ and $p \in \{0, 1\}$. Observe that each layer is partitioned into two half-layers, each of size 2^{n-2} . Moreover, if a perfect matching of Q_n contains a half-layer, then it actually is a layer of Q_n .

We shall see in the next section that half-layers are obstacles that cannot be overcome. More precisely, we shall see in Lemma 6 that there is no Hamiltonian cycle avoiding a half-layer. The need to treat half-layers as a special case motivates the following definitions.

Given a matching M in Q_n , we call $d \in [n]$

- a *main dimension* of M in Q_n if M^d contains a half-layer in Q_n ;
- a *splitting dimension* for M if M_i^d does not contain a half-layer in Q_i^d for both $i \in \{L, R\}$.

Now we show that the main dimension is uniquely determined.

Proposition 2 Let d be a main dimension of a matching M in Q_n , $n \geq 2$. Then,

- (i) M contains only edges of dimension d . Consequently, d is the only main dimension of M .
- (ii) d is the unique main dimension of M_i^a in Q_i^a for every $a \in [n] \setminus \{d\}$ and $i \in \{L, R\}$ provided $n \geq 3$.

Proof: Since for every edge $uv \in E(Q_n)$ of dimension $d' \neq d$ we have $p(u) \neq p(v)$, it follows that at least one of u, v must be incident with an edge of M^d . Hence $uv \notin M$ and consequently, $M_L^{d'} = M_R^{d'} = \emptyset$. This, together with the fact that M^d contains a half-layer and therefore must be nonempty, verifies part (i).

To see why (ii) holds, note that if $n \geq 3$, then a half-layer in Q_n contains a half-layer in both Q_L^a and Q_R^a by definition. It follows that d is a main dimension of M_i^a in Q_i^a while the uniqueness follows from part (i). \square

A matching M in Q_n is called *aligned* if there exists a dimension $d \in [n]$ such that $|M_L^d| \leq 1$ and $|M_R^d| \leq 1$. Otherwise, it is called *unaligned*. Note that a matching containing a half-layer is always aligned by Proposition 2(i). For aligned matchings our problem is easy, as we shall see in the next section. But this is not the case with unaligned matchings. For them, we use the following lemma.

Lemma 5 *If M is an unaligned matching in Q_n , $n \geq 4$, then there are at least two splitting dimensions for M .*

Proof: First note that if every $a \in [n]$ is a splitting dimension for M , we are done. Hence we can assume that this is not the case, i. e., there exist distinct $a, b \in [n]$ such that b is the main dimension of M_L^a in Q_L^a .

Case 1: b is not a splitting dimension for M . Then there exist $i \in \{L, R\}$ and $d \in [n] \setminus \{b\}$ such that d is the main dimension of M_i^b . Assume that $d \neq a$. Then Proposition 2 (ii) implies that d is also the main dimension of $(M_i^b)_L^a$ in $(Q_i^b)_L^a$. It follows that $(M_L^a)_i^b = (M_i^b)_L^a$ contains a half-layer. On the other hand, as b is the main dimension of M_L^a , Proposition 2 (i) reveals that M_L^a contains only edges of dimension b and therefore $(M_L^a)_i^b = \emptyset$. This, however, leads to a contradiction since a half-layer is always nonempty. Hence we conclude that $d = a$.

Now choose an arbitrary $c \in [n] \setminus \{a, b\}$ and $j \in \{L, R\}$ and suppose that M_j^c contains a half-layer in Q_j^c . Using Proposition 2 (ii) again, a and b are the main dimensions of $(M_i^b)_j^c$ and $(M_L^a)_j^c$ in $(Q_i^b)_j^c$ and $(Q_L^a)_j^c$, respectively. Since $(M_i^b)_j^c = (M_j^c)_i^b$ and $(M_L^a)_j^c = (M_j^c)_L^a$, part (ii) of Proposition 2 implies that a and b are also main dimensions of M_j^c in Q_j^c , while part (i) then reveals that $a = b$, which is a contradiction with our assumption. Hence c must be a splitting dimension for M . It follows that there exist $n - 2 \geq 2$ splitting dimensions in this case.

Case 2: b is a splitting dimension for M . In this case we need to show that there exists another splitting dimension for M , different from b . Assume, by way of contradiction, that this is not the case. Then for any $c \in [n] \setminus \{b\}$ there exists $i \in \{L, R\}$ such that M_i^c contains a half-layer. Recall that b is the main dimension of M_L^a in Q_L^a . If $c \neq a$, then Proposition 2 (ii) implies that b is the main dimension of $(M_L^a)_i^c = (M_i^c)_L^a$ in $(Q_L^a)_i^c$ and therefore b is also the main dimension of M_i^c in Q_i^c . Hence we conclude that for any $c \in [n] \setminus \{b\}$ there exists $i \in \{L, R\}$ such that b is the main dimension of M_i^c in Q_i^c .

Since M is an unaligned matching, there must exist $i \in \{L, R\}$ such that M_i^b contains two distinct edges e_1, e_2 . Note that both $\dim(e_1)$ and $\dim(e_2)$ are different from b . By Proposition 1 there must be a dimension $d \in [n] \setminus \{b\}$ such that $|M_j^d \cap \{e_1, e_2\}| = 1$ for each $j \in \{L, R\}$. But then each M_j^d contains an edge of dimension distinct from b , which by Proposition 2 (i) means that b cannot be the main dimension of M_j^d , contrary to the conclusion of the previous paragraph. \square

5 Admissible configurations

A nonempty matching M is called an *almost-layer (of dimension d)* in Q_n if there exist vertices $u, v \in Q_L^d$ of different parities such that M consists of all edges of dimension d except uu^d and vv^d . Pairs $\{u, v\}$ and $\{u^d, v^d\}$ are called the *free pairs* of M .

The next lemma gives necessary conditions for a Gray code avoiding a given matching.

Lemma 6 *Let M be a matching and u, v vertices of Q_n . If there exists a Hamiltonian path in $Q_n - M$ between u and v , then*

- (i) $p(u) \neq p(v)$;
- (ii) for every $d \in \Delta(u, v)$ there exists an edge $e \in E(Q_n) \setminus M$ of dimension d such that $d(u, e)$ is odd;
- (iii) for every $d \in [n] \setminus \Delta(u, v)$ there exist two edges in $E(Q_n) \setminus M$ of dimension d of different parities;
- (iv) M contains no almost-layer with a free pair $\{u, v\}$.

Proof: Claims (i)–(iii) follow from the facts that in a hypercube the number of vertices of odd parity equals the number of vertices of even parity, and that the parity of vertices on every path alternates. To verify (iv), observe that if M is an almost-layer with a free pair $\{u, v\} \subseteq V(Q_L^d)$, then every path P_{uv} in $Q_n - M$ avoids either all vertices of $V(Q_L^d) \setminus \{u, v\}$, or all vertices of $V(Q_R^d)$, and therefore cannot be Hamiltonian. \square

We say that a triple (u, v, M) is a *configuration* in Q_n if M is a matching in Q_n and u and v are vertices of different parities, i. e., condition (i) of Lemma 6 holds. Since we do not need to distinguish between vertices u and v , we consider the configurations (u, v, M) and (v, u, M) to coincide. If, moreover, conditions (ii)–(iv) of Lemma 6 hold, we say that the configuration (u, v, M) is *admissible*.

The conditions (ii) and (iii) of Lemma 6 can be unified into one condition using a slight modification of the concept of a half-layer. Note that since a half-layer contains only edges of the same parity, the distances of a given vertex to edges of a given half-layer must also have the same parity. If the distance of a vertex u to edges of a half-layer M in Q_n is odd, we say that M is an *odd half-layer* for the vertex u .

Proposition 3 *A configuration (u, v, M) is admissible if and only if the following holds*

- (i) M contains no odd half-layer for u or v ; and
- (ii) M contains no almost-layer with a free pair $\{u, v\}$.

The next lemma shows that these conditions are also sufficient for the existence of a Hamiltonian path in Q_n , $n \geq 4$, provided that M is aligned.

Lemma 7 *Let M be an aligned matching, and let u and v be vertices of Q_n , $n \geq 4$. If (u, v, M) is an admissible configuration, then $Q_n - M$ contains a Hamiltonian path between u and v .*

Proof: Since M is an aligned matching, there exists $d \in [n]$ such that $|M_L^d| \leq 1$ and $|M_R^d| \leq 1$. Without a loss of generality assume that $u \in V(Q_L^d)$ and consider the following two cases:

Case 1: $v \in V(Q_R^d)$. Since (u, v, M) is an admissible configuration, there exists a vertex $w \in V(Q_L^d)$ such that $p(u) \neq p(w)$ and $ww^d \notin M$. Note that then also $p(w^d) \neq p(v)$. Now, by Lemma 2, there exist Hamiltonian paths P_{uw} of $Q_L^d - M_L^d$ and P_{w^dv} of $Q_R^d - M_R^d$. Then $P_{uv} := P_{uw} + P_{w^dv}$ is the required Hamiltonian path.

Case 2: $v \in V(Q_L^d)$. Here, we consider the following subcases.

Subcase 2.1: $M_L^d = \emptyset$. Since (u, v, M) is an admissible configuration, there are vertices $x, y \in V(Q_L^d)$ such that $p(x) \neq p(y)$, $xx^d \notin M$, $yy^d \notin M$, and $\{u, v\} \neq \{x, y\}$. Apply Lemma 2 to obtain a Hamiltonian path $P_{x^dy^d}$ of $Q_R^d - M_R^d$. Note that as $p(u) \neq p(v)$ and $p(x) \neq p(y)$, we can assume that also $p(u) \neq p(x)$ and $p(v) \neq p(y)$, interchanging x and y if necessary.

We conclude the subcase with the following construction. If $\{u, v\} \cap \{x, y\} = \emptyset$, then apply Lemma 3 to obtain spanning paths P_{ux} and P_{vy} of Q_L^d and put $P_{uv} := P_{ux} + P_{x^dy^d} + P_{yv}$. Otherwise it must be the case that $|\{u, v\} \cap \{x, y\}| = 1$. Assume without a loss of generality that $v = x$ and $u \neq y$. Then apply Lemma 1 to obtain a Hamiltonian path P_{uy} of $Q_L^d - v$ and put $P_{uv} := P_{uy} + P_{y^dx^d} + P_{xx}$. In both cases we obtained the required Hamiltonian path.

Subcase 2.2: $M_L^d = \{e\}$. If $e \neq uv$, then put $xy = e$ and apply the construction of Subcase 2.1. So, we may assume that $e = uv$. Since (u, v, M) is an admissible configuration, there is a vertex $y \in V(Q_L^d) \setminus \{u, v\}$ such that $yy^d \notin M$. Assume without a loss of generality that $p(u) \neq p(y)$. Finally, put $x = v$ and apply the construction of Subcase 2.1 in order to conclude this case. \square

Note that the above lemma does not hold for $n = 3$, see e. g. configurations (e), (f) or (g) in Figure 1. The case of small dimensions is analyzed separately in Appendix A and B.

6 Gray codes in hypercubes of higher dimensions

In this section we use $\text{AL}(u, v, M, Q_n)$ to denote the fact that a matching M contains an almost-layer in Q_n with a free pair $\{u, v\}$. Recall that if $\text{AL}(u, v, M, Q_n)$ holds, then there exists d such that M^d consists of all edges of dimension d except uu^d and vv^d . The following simple observation is used later.

Proposition 4 *Let M be a matching which contains an almost-layer A with a free pair $\{u, v\}$ in Q_n , $n \geq 4$.*

(i) *If $\text{AL}(u, w, M, Q_n)$ holds, then $v = w$.*

(ii) *If at least one of vertices x, y is incident with an edge of A , then $\text{AL}(x, y, M, Q_n)$ does not hold.*

Note that the assumption $n \geq 4$ is for part (ii) essential, as it fails to hold in the case that M is the perfect matching of Q_3 depicted in Figure 2(10). Now we are ready to resolve the case of matchings not containing a half-layer.

Lemma 8 *Let $u, v \in V(Q_n)$, $n \geq 4$, such that $p(u) \neq p(v)$ and let M be a matching in Q_n containing no half-layer. Then $Q_n - M$ contains a Hamiltonian path between u and v unless M is an almost-layer in Q_n with a free pair $\{u, v\}$.*

Proof: We argue by induction on n . Since the case $n = 4$ is settled by Lemma 14 in Appendix B, assume that $n > 4$. If M is aligned, the statement follows from Lemma 7. If M is unaligned, then by Lemma 5, there is $d \in [n]$ such that M_i^d contains no half-layer in Q_i^d for both $i \in \{L, R\}$. Without a loss of generality assume that $u \in V(Q_L^d)$. To obtain the desired Hamiltonian path P_{uv} of $Q_n - M$, consider the following two cases:

Case 1: $v \in V(Q_R^d)$. Since M does not contain a half-layer, there is a vertex $w \in V(Q_L^d)$ such that

$$p(u) \neq p(w) \quad \text{and} \quad ww^d \notin M. \quad (1)$$

Notice that also $p(w^d) \neq p(v)$. We claim that w can be chosen so that neither $\text{AL}(u, w, M_L^d, Q_L^d)$ nor $\text{AL}(w^d, v, M_R^d, Q_R^d)$ holds. Indeed, if M_L^d contains an almost-layer A in Q_L^d with a free pair $\{u, w\}$, then each edge of A contains one vertex that can play the role of w in (1). Hence there are still $|A| = 2^{n-2} - 2 > 2$ choices for w , and M_R^d may contain an almost-layer in Q_R^d with a free pair $\{w^d, v\}$ for no more than one of them by Proposition 4(i).

It remains to apply the induction to obtain Hamiltonian paths P_{uw} and $P_{w^d v}$ of $Q_L^d - M_L^d$ and $Q_R^d - M_R^d$, respectively, and finally put $P_{uv} := P_{uw} + P_{w^d v}$ to conclude this case.

Case 2: $v \in V(Q_L^d)$. Consider the following subcases.

Subcase 2.1: $\text{AL}(u, v, M_L^d, Q_L^d)$ holds. Since M_L^d contains an almost-layer A with $2^{n-2} - 2 > 3$ edges, Proposition 4(ii) implies that there must be an edge $xy \in A$ such that M_R^d contains no almost-layer in Q_R^d with a free pair $\{x^d, y^d\}$. Thus, by the induction hypothesis, there are Hamiltonian paths P_{uv} and $P_{x^d y^d}$ of $Q_L^d - (M_L^d \setminus \{xy\})$ and $Q_R^d - M_R^d$, respectively. Note that by Lemma 6, the path P_{uv} passes through the edge xy , and hence there are subpaths P_{ux} and P_{yv} of P_{uv} such that $P_{uv} = P_{ux} + P_{yv}$. It remains to put $P_{uv} := P_{ux} + P_{x^d y^d} + P_{yv}$ to complete this subcase.

Subcase 2.2: $\text{AL}(u, v, M_L^d, Q_L^d)$ does not hold. First apply the induction hypothesis to obtain a Hamiltonian path P_{uv}^L of $Q_L^d - M_L^d$. Next, distinguish the following two possibilities.

Subcase 2.2.1: $\{xx^d, yy^d\} \cap M = \emptyset$ for some pair x, y of neighbors on P_{uv}^L . We claim that vertices x and y can be chosen so that $\text{AL}(x^d, y^d, M_R^d, Q_R^d)$ does not hold. To verify the claim, suppose, by way of contradiction, that M_R^d contains an almost-layer A in Q_R^d with a free pair $\{x^d, y^d\}$. Denote by S the set of vertices z of Q_L^d such that z^d is incident with an edge of A . Then

$$|S| = 2|A| = 2^{n-1} - 4 > 2^{n-2} = |V(Q_L^d)|/2 = |V(P_{uv}^L)|/2$$

and hence there exist $x, y \in S$ that are neighbors on P_{uv}^L . Then, it follows by Proposition 4(ii) that $\text{AL}(x^d, y^d, M_R^d, Q_R^d)$ does not hold.

As in Subcase 2.1, it remains to apply the induction to obtain a Hamiltonian path $P_{x^d y^d}$ of $Q_R^d - M_R^d$ and put $P_{uv} := P_{ux} + P_{x^d y^d} + P_{yv}$, where P_{ux} and P_{yv} are the subpaths of P_{uv}^L satisfying $P_{uv}^L = P_{ux} + P_{yv}$.

Subcase 2.2.2: $\{xx^d, yy^d\} \cap M \neq \emptyset$ for each pair x, y of neighbors on P_{uv}^L . By Lemma 5 there exists another splitting dimension $d' \neq d$ and we claim that Subcase 2.2.2 for d' cannot occur. To verify the claim, first observe that

$$|M^d| \geq |V(P_{uv}^L)|/2 = 2^{n-2}. \quad (2)$$

If this inequality is strict, then $|M| \leq 2^{n-1}$ implies that $|M^{d'}| < 2^{n-2}$, contrary to (2), and hence the claim holds. Thus we can assume that

$$|M^d| = |M^{d'}| = 2^{n-2}. \quad (3)$$

This means that $|M^d| = |V(P_{uv}^L)|/2$, which together with the assumption of this subcase implies that $|\{xx^d, yy^d\} \cap M^d| = 1$ for each pair x, y of neighbors on P_{uv}^L . Since the parity of consecutive vertices on P_{uv}^L alternates, it follows that if $uu^d \in M^d$, then $xx^d \in M^d$ for each vertex $x \in V(P_{uv}^L)$ with $p(u) = p(x)$. However, this would mean that M contains a half-layer, contrary to our assumption. Since the same reasons apply to the endvertex v , we conclude that neither u nor v are incident with an edge of M^d . Applying the same argument to the dimension d' , it follows that

$$|M^d| + |M^{d'}| \leq |V(Q_n) \setminus \{u, v\}|/2 = 2^{n-1} - 1,$$

contrary to (3). \square

7 The main results

Now we are ready to formulate the necessary and sufficient conditions for (cyclic) Gray codes avoiding a given matching. Note that the conditions are expressed in terms of half-layers and almost-layers, which were defined in Sections 4 and 5, respectively.

Theorem 1 *Let M be a matching, and let u and v be vertices of Q_n , $n \geq 4$. Then Q_n has a Gray code between u and v that avoids M if and only if M contains no odd half-layer for u or v and no almost layer with a free pair $\{u, v\}$.*

Proof: Recall that (u, v, M) is an admissible configuration if and only if the left side of the equivalence holds, by Proposition 3. The necessity is settled by Lemma 6. The sufficiency follows from Lemma 7 in the case M contains a half-layer, and from Lemma 8 otherwise. \square

It should be noted that for $n = 3$ the problem is fully described by Lemma 9 in Appendix A, and for $n \leq 2$ it is trivial.

Corollary 1 *Let M be a matching in Q_n , $n \geq 4$. Then Q_n has a cyclic Gray code that avoids M if and only if M does not contain a half-layer.*

Proof: Observe that the following two equivalences hold.

- $Q_n - M$ contains a Hamiltonian cycle $\iff Q_n - M$ contains a Hamiltonian path P_{uv} for some edge $uv \in E(Q_n)$;
- there exists an admissible configuration (u, v, M) for some edge $uv \in E(Q_n)$ $\iff M$ does not contain a half-layer.

The corollary now follows from Theorem 1. □

Corollary 2 *Let M be a perfect matching in Q_n . Then the following three statements are equivalent:*

- (i) Q_n has a Gray code avoiding M ;
- (ii) Q_n has a cyclic Gray code avoiding M ;
- (iii) $Q_n - M$ is connected.

Proof: First observe that clearly (iii) \implies (i) and (i) \implies (iii). Hence it only remains to prove that (iii) \implies (ii). To that end, notice that for any perfect matching M of Q_n ,

$$M \text{ contains a half-layer in } Q_n \iff M \text{ forms a layer of } Q_n \iff Q_n - M \text{ is disconnected.}$$

The validity of the implication (iii) \implies (ii) for $n \geq 4$ now follows from Corollary 1, the case $n = 3$ may be verified by inspection of parts (9) and (10) of Figure 2, and the case $n \leq 2$ is trivial. □

Appendix A: Gray codes in Q_3

At this point it only remains to settle the initial cases $n = 3$ and $n = 4$. Note that we were able to use computer search to verify the main result of this part, namely Lemma 14, which is needed for the induction basis in the proof of Lemma 8. However, considering the difficulties in independently verifying computer-aided proofs, here we provide arguments that may be verified without a computer assistance. This involves a rather elaborate case analysis, but we believe that in this case it is indispensable.

A configuration (u, v, M) in Q_n is *good* if there is a Hamiltonian path of $Q_n - M$ between u and v . Otherwise it is *bad*. In this terminology, our aim is to characterize all good configurations.

A configuration (u, v, M_1) *contains* a configuration (u, v, M_2) if $M_1 \supseteq M_2$. A bad configuration is *minimal* if it does not contain any other bad configuration. An admissible configuration is *maximal* if it is not contained in any other admissible configuration. Similarly, a *matching* is *maximal* if it is not contained in any other matching.

We start with the list of all minimal bad configurations in Q_3 .

Lemma 9 *Let u and v be vertices of different parity and let M be a matching in Q_3 . Then there is a Hamiltonian path of $Q_3 - M$ between u and v unless (u, v, M) contains one of the bad configurations depicted in Figure 1.*

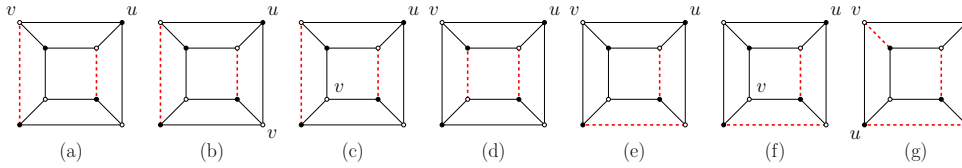

Fig. 1: The minimal bad configurations in Q_3 .

Proof: First observe that each configuration (u, v, M) in Figure 1 is bad. Note that M is presented with dashed lines. Moreover, observe that there are no two configurations in Figure 1 such that the first one contains the other one.

Now we show that the configuration (u, v, M) is either good or contains one of the bad configurations in Figure 1. The hypercube Q_3 has 10 non-isomorphic matchings, including the empty one, depicted in Figure 2(1)-(10). Note that in this figure the edges of the matchings are presented with dashed lines. So M is one of the following cases in Figure 2.

- (1), (2): In these cases M has at most one edge, thus the configuration (u, v, M) is good by Lemma 2.
- (3), (6): Observe that if $u \in \{u_1, u_2\}$ and $v \in \{v_1, v_2\}$, then the configuration (u, v, M) is good. Otherwise it contains a configuration of type (a), (b), or (c) in Figure 1.
- (4): Observe that the configuration (u, v, M) is good unless it equals (u_1, v_1, M) or (u_2, v_2, M) which are of type (d) in Figure 1.
- (5): Observe that the configuration (u, v, M) is good unless it equals (u_1, v_1, M) , (u_1, v_2, M) , or (u_2, v_2, M) which are of type (e) or (f) in Figure 1.
- (7): In this case $Q_3 - M - xy$ is a Hamiltonian cycle. Thus the configuration (u, v, M) is good if uv is an edge on this cycle. Furthermore, if the configuration (u, v, M) equals (u_1, v_1, M) or (u_2, v_2, M) , observe that it is also good. Otherwise it contains a configuration of type (e) or (f) in Figure 1.

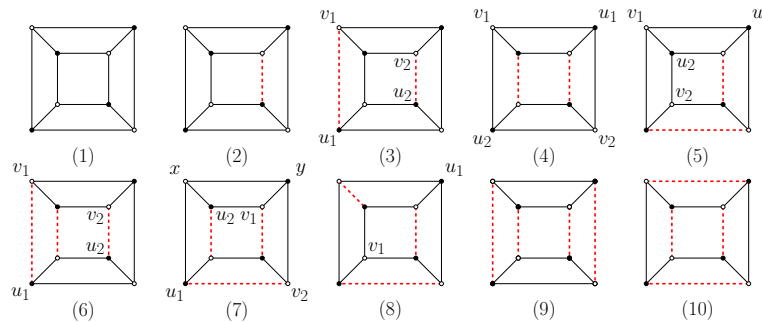

Fig. 2: All matchings in Q_3 up to isomorphism.

- (8): Observe that if $uv \in M$, then the configuration (u, v, M) is good. Furthermore, it is also good if $d(u, v) = 3$ and $\{u, v\} \neq \{u_1, v_1\}$. Otherwise it contains a configuration of type (e), (f), or (g) in Figure 1.
- (9): In this case $Q_3 - M$ is disconnected so (u, v, M) is a bad configuration. Observe that it contains a configuration of type (a), (b), or (c) in Figure 1.
- (10): In the last case $Q_3 - M$ is a Hamiltonian cycle. Thus the configuration (u, v, M) is good if uv is an edge on this cycle. Otherwise it contains a configuration of type (e) or (f) in Figure 1.

This completes the analysis of all cases and establishes the lemma. □

The following two lemmas will be useful for inquiry of Q_4 in the next section. The first lemma applies typically for configurations (u, v, M) such that both u and v belong to a same subcube Q_L^d or Q_R^d which contains at most 2 edges of M .

Lemma 10 *Let u and v be vertices of different parity and let e_1 and e_2 be distinct edges in Q_3 . Then there is a Hamiltonian path of Q_3 between u and v that*

- (i) *contains exactly one of e_1 and e_2 ; or*
- (ii) *avoids both e_1, e_2 but contains an edge xy such that $x \in e_1$ and $y \in e_2$.*

Proof: Suppose first that u and v are at distance 3. From Figure 3(1) it is obvious that all Hamiltonian paths between u and v are isomorphic. Moreover, each of them contains one edge of the upper level, one edge of the lower level, and five edges of the middle level. Considering few cases, regarding the levels that contain e_1 and e_2 , it is easy to find a suitable path.

Suppose now that uv is an edge of Q_3 . We distinguish three cases:

Case 1: Edges e_1 and e_2 are adjacent at some vertex x . If $x = u$, then assume that $e_1 = uy \neq uv$ and apply Lemma 1 to find a Hamiltonian path of $Q_3 - u$ between y and v . Extending this path with the edge $e_1 = uy$ we obtain a Hamiltonian path of Q_3 between u and v that contains e_1 and avoids e_2 . If $x = v$, then proceed similarly. Otherwise we have $x \notin \{u, v\}$. The Hamiltonian path between u and v that avoids e_1 from Lemma 2 contains e_2 since it passes through the vertex x .

Case 2: Edges e_1 and e_2 are at distance 1. If the edge uv is adjacent to both e_1 and e_2 , then we have two non-isomorphic cases in Figures 3(2)-(3) with desired Hamiltonian paths. Otherwise, we may assume that $x \in e_1, y \in e_2$, and $y \notin \{u, v\}$ for some edge xy . The Hamiltonian path between u and v that avoids e_1 from Lemma 2 contains e_2 or xy since it passes through the vertex y .

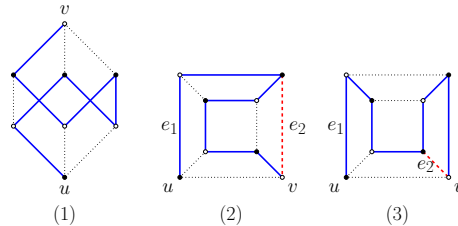

Fig. 3: An illustration for Lemma 10.

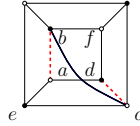

Fig. 4: The configuration of Lemma 11.

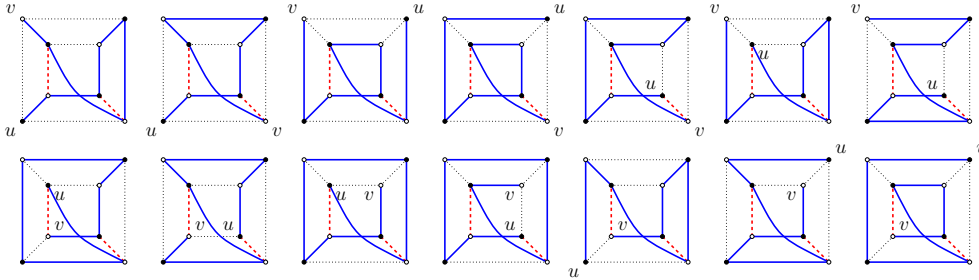

Fig. 5: Hamiltonian paths in Lemma 11 for each pair $\{u, v\}$ of endvertices.

Case 3: Edges e_1 and e_2 are at distance 2. If $e_1 = uv$, apply Corollary 4 to find a Hamiltonian path between u and v that contains edge e_2 . If $e_2 = uv$, proceed similarly. Otherwise the configuration $(u, v, \{e_1, e_2\})$ is bad since it is of type (a), (b), or (c) in Figure 1. Thus the Hamiltonian path between u and v that avoids e_1 from Lemma 2 contains e_2 . This completes the analysis of all cases. \square

The second lemma applies for example when $M_R^d = \{ab, cd\}$ as in Figure 4 and Q_L^d contains a path between vertices b^d and c^d . The extra edge bc represents this path.

Lemma 11 Let a, b, c, d, e, f be vertices of Q_3 as depicted in Figure 4 and $u, v \in V(Q_3)$ be any two vertices of different parity. Then $Q_3 + bc$ has a Hamiltonian path between u and v that contains the edge bc and avoids $\{ab, cd\}$ unless $\{u, v\} = \{b, c\}$ or $\{u, v\} = \{e, f\}$.

Proof: By exhausting all 14 possibilities for $\{u, v\}$, as it is presented in Figure 5, one can verify the validity of the lemma. \square

Appendix B: Gray codes in Q_4

If M is aligned in Q_4 , we can use Lemma 7 which holds for every $n \geq 4$. Thus, it remains to consider admissible configurations (u, v, M) only with an unaligned matching M . We start with the list of all maximal unaligned matchings in Q_4 .

Let $m(M)$ denote the maximum number of edges of M of the same dimension, i. e., $m(M) = \max_{d \in [n]} |M^d|$.

Lemma 12 Let M be a maximal unaligned matching in Q_4 . Then $m(M) \in \{2, 3, 4\}$ and M is isomorphic to one of the matchings in Figures 6-8.

Proof: Let $d \in [4]$ be a dimension with the maximal number of edges of M , i. e., $|M^d| = m(M)$. Since M is unaligned, we have $|M_L^d| \geq 2$ or $|M_R^d| \geq 2$, say $|M_L^d| \geq 2$. Thus among eight vertices of

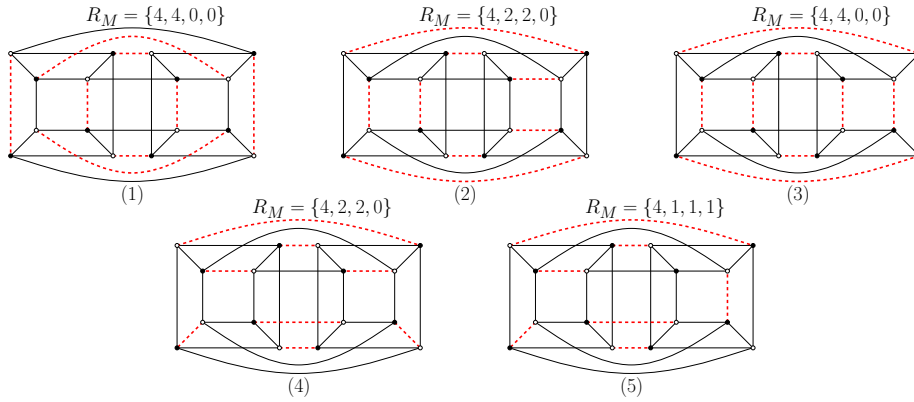

Fig. 6: All maximal unaligned matchings M of Q_4 with $m(M) = 4$.

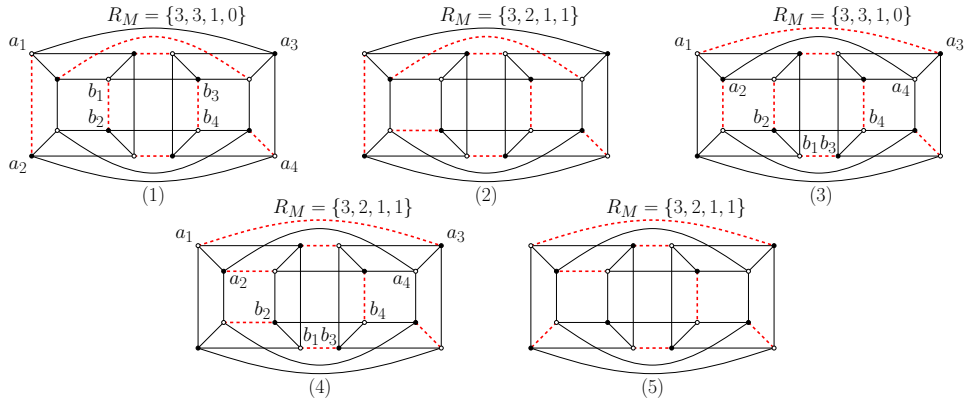

Fig. 7: All maximal unaligned matchings M of Q_4 with $m(M) = 3$.

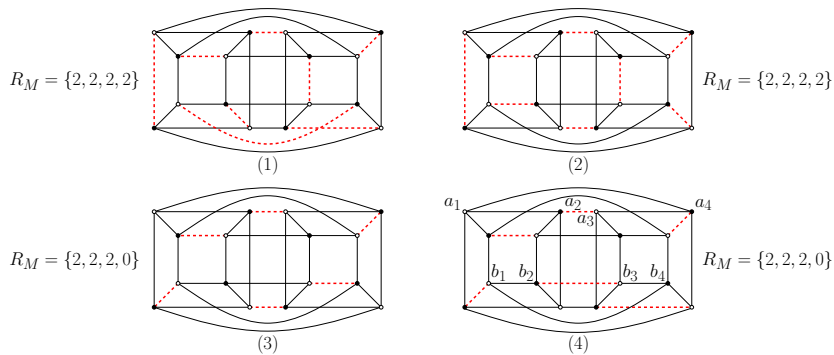

Fig. 8: All maximal unaligned matchings M of Q_4 with $m(M) = 2$.

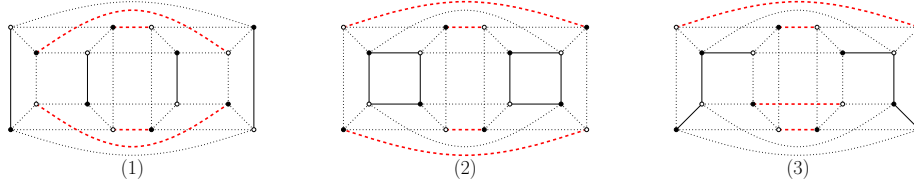

Fig. 9: All sets M^d with 4 edges in a maximal unaligned matching M of Q_4 .

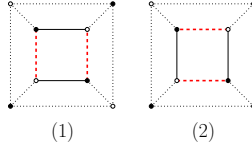

Fig. 10: All maximal matchings of G in Subcase 1.2.

Q_L^d there are at most four vertices that are not matched by M_L^d . Hence $m(M) \leq 4$. On the other hand, every maximal matching in Q_4 contains at least 6 edges [6], hence at least 2 edges from M are of a same dimension. This implies that $m(M) \geq 2$. So $m(M) \in \{2, 3, 4\}$.

Let G_L and G_R be the graphs obtained from Q_L^d and Q_R^d , respectively, by removing all vertices incident with M^d . Note that G_L and G_R are isomorphic, so let us write simply G when it is clear from the context for which of the graphs we speak. Since M is maximal, both M_L^d and M_R^d are maximal matchings of G .

To show that M is one of the matchings in Figures 6-8, we first consider the set M^d and then the combination of sets M_L^d and M_R^d . The matchings M^d , M_L^d and M_R^d in the following figures are represented by dashed lines, the edges of the graph G are bold, and the remaining edges are dotted.

Note that in the following figures the isomorphic graphs G_L and G_R are presented in a mirrored way, so the matchings M_L^d and the maximal matchings of G are also presented in a mirrored way.

Case 1: $m(M) = 4$. Since M is unaligned, there are three non-isomorphic combinations of four edges in M^d ; see Figure 9. We consider now three possibilities.

Subcase 1.1: M^d is as in Figure 9(1). Obviously, there is only one maximal matching of G . Thus M_L^d and M_R^d are uniquely determined and the matching M is as in Figure 6(1).

Subcase 1.2: M^d is as in Figure 9(2). There are two maximal matchings of G depicted in Figure 10. By symmetry, we may assume that M_L^d is as in Figure 10(1). Now, if M_R^d is also as in Figure 10(1), the matching M corresponds to Figure 6(3). And, if M_R^d is as in Figure 10(2), then M corresponds to Figure 6(2).

Subcase 1.3: M^d is as in Figure 9(3). There are two maximal matchings of G depicted in Figure 12. By the maximality of M , it follows that M_L^d and M_R^d are not both as in Figure 12(2). Now, if both of them are as in Figure 12(1), we infer Figure 6(4). Finally, if one of them is as in Figure 12(1), and the other one as in Figure 12(2), we infer Figure 6(5).

Case 2: $m(M) = 3$. Since M is unaligned, there are two non-isomorphic combinations of three edges in M^d which are depicted in Figure 11. Consider now these two cases separately.

Subcase 2.1: M^d is as in Figure 11(1). There are three maximal matchings of G depicted in Figure 13. By symmetry, we may assume that if M_L^d is as in Figure 13(x), then M_R^d is as in Figure 13(y) where $1 \leq x \leq y \leq 3$. Moreover, since M is a maximal matching, we infer $x \neq y$. We have the following

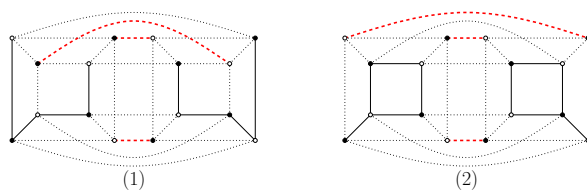

Fig. 11: All sets M^d with 3 edges in a maximal unaligned matching M of Q_4 .

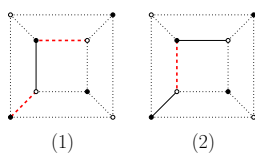

Fig. 12: All maximal matchings of G in Subcase 1.3.

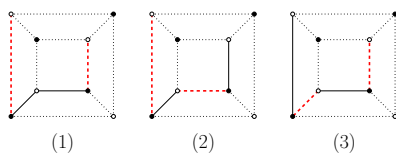

Fig. 13: All maximal matchings of G in Subcase 2.1.

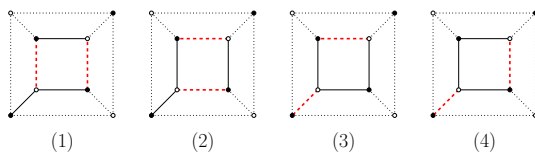

Fig. 14: All maximal matchings of G in Subcase 2.2.

possibilities for the pair (x, y) :

- (1, 3): The matching M is as in Figure 7(1);
- (2, 3): The matching M is as in Figure 7(2);
- (1, 2): This case is isomorphic to the case (1, 3). Indeed, consider the isomorphism of Q_4 that interchanges vertices a_i and b_i in Figure 7(1) for every $i \in [4]$ and fixes all other vertices.

Subcase 2.2: M^d is as in Figure 11(2). There are four maximal matchings of G depicted in Figure 14. By symmetry, we may assume that if M_L^d is as in Figure 14(x), then M_R^d is as in Figure 14(y) where $1 \leq x \leq y \leq 4$. Moreover, since M is a maximal matching, it follows that $x \neq y$. Thus, we have the following possibilities for the pair (x, y) :

- (1, 4): The matching M is as in Figure 7(3);
- (2, 4): The matching M is as in Figure 7(4);
- (3, 4): The matching M is as in Figure 7(5);
- (1, 2): This case does not occur since M is a maximal matching;
- (1, 3) and (2, 3): These cases are isomorphic to the cases (2, 4) and (1, 4), respectively. Indeed, consider the isomorphism of Q_4 that interchanges vertices a_i and b_i in Figures 7(4) and 7(3) for every $i \in [4]$ and that fixes all other vertices.

Case 3: $m(M) = 2$. Let $k(M)$ be the minimal distance of distinct edges of M of a same dimension, i. e.,

$$k(M) = \min\{d(e_1, e_2) \mid e_1, e_2 \in M^i \text{ for some } i \in [4] \text{ and } e_1 \neq e_2\}.$$

We assume that M^d contains edges at distance $k(M)$, otherwise choose d accordingly. For each $k(M) \in [3]$ we have M^d in Figure 15.

Subcase 3.1: $k(M) = 3$. Thus M^d is as in Figure 15(1). There are five maximal matchings of G depicted in Figure 16. Observe that neither M_L^d nor M_R^d is as in Figures 16(3)-(5) since $k(M) = 3$. Moreover, M_d^L and M_d^R are not both as in Figure 16(1), or both as in Figure 16(2) since $k(M) = 3$. Thus, one of them is as in Figure 16(1), and the other one as in Figure 16(2). Hence M corresponds to Figure 8(1).

Subcase 3.2: $k(M) = 2$. Thus M^d is as in Figure 15(2). There are seven maximal matchings of G depicted in Figure 17. Observe that neither M_L^d nor M_R^d is as in Figures 17(6)-(7) since $k(M) = 2$. Furthermore, neither M_L^d nor M_R^d is as in Figure 17(5) since all matchings of G in Figures 17(1)-(5) contain at least one edge of e_1 or e_2 and $k(M) = 2$. By symmetry, we may assume that if M_L^d is as in Figure 17(x), then M_R^d is as in Figure 17(y) where $1 \leq x \leq y \leq 4$. Moreover, $x \neq y$ since M is a maximal matching. We have the following possibilities for the pair (x, y) :

- (1, 2): The matching M is as in Figure 8(4);
- (3, 4): This case is isomorphic to the case (1, 2). Indeed, consider the isomorphism of Q_4 that interchanges vertices a_i and b_i in Figure 8(4) for every $i \in [4]$ and fixes all other vertices.
- (1, 3), (1, 4), (2, 3), and (2, 4): These cases do not occur since M is a maximal matching.

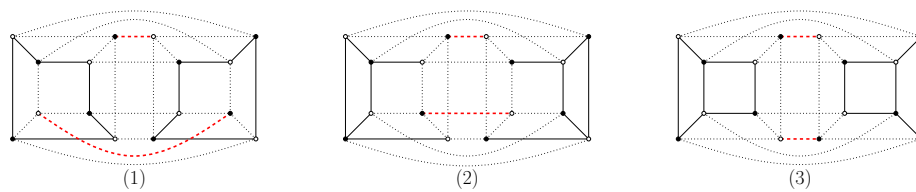

Fig. 15: All sets M^d with 2 edges in a maximal unaligned matching M of Q_4 .

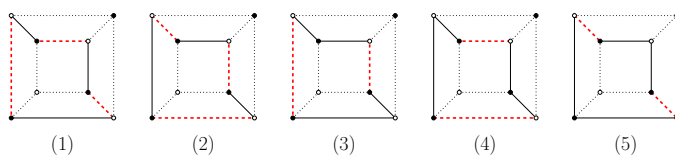

Fig. 16: All maximal matchings of G in Subcase 3.1.

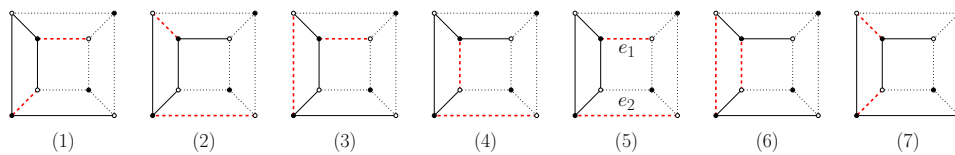

Fig. 17: All maximal matchings of G in Subcase 3.2.

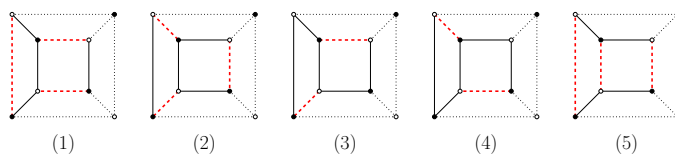

Fig. 18: All maximal matchings of G in Subcase 3.3.

Subcase 3.3: $k(M) = 1$. Thus M^d is as in Figure 15(3). There are five maximal matchings of G depicted in Figure 18. Observe that neither M_L^d nor M_R^d is as in Figure 18(5) since $m(M) = 2$. By symmetry, we may assume that if M_L^d is as in Figure 18(x), then M_R^d is as in Figure 18(y) where $1 \leq x \leq y \leq 4$. We have the following possibilities for the pair (x, y) :

(1, 2): The matching M is as in Figure 8(2);

(3, 4): The matching M is as in Figure 8(3);

(1, 1), (1, 3), (1, 4), (2, 2), (2, 3), and (2, 4): These cases do not occur since $m(M) = 2$;

(3, 3) and (4, 4): These cases do not occur since M is a maximal matching.

Note that the choice of the dimension d was not determined uniquely. Therefore, to conclude the proof, we need to verify that the matchings in Figures 6-8 are non-isomorphic.

Define the *mark* of M to be the collection $R_M = \{|M^d|\}_{d \in [n]}$. Clearly, matchings with different marks are not isomorphic. So we need to examine only matchings with different marks in Figures 6-8. This can be easily verified by the reader. \square

Lemma 13 *Let (u, v, M) be a maximal admissible configuration in Q_n with an unaligned matching M . Then M is maximal with respect to inclusion.*

Proof: Suppose on the contrary that M is not maximal, i. e., $M \cup \{e\}$ is a matching for some edge $e \in E(Q_n) \setminus M$. Let d be the dimension of e . Since M is unaligned, we have $|M_L^d| \geq 2$ or $|M_R^d| \geq 2$, so we may assume that M_L^d contains edges x_1x_2 and x_3x_4 . Let $e_i = x_ix_i^d$ for $i \in [4]$.

Since $d(e_1, e_2)$ is odd, $d(e_3, e_4)$ is odd, e_1, e_2, e_3, e_4 are not in $M \cup \{e\}$, and (u, v, M) is admissible, it follows from the definition that $(u, v, M \cup \{e\})$ is also admissible. But this contradicts the assumption that (u, v, M) is a maximal admissible configuration. \square

Now we are ready to find a Hamiltonian path of $Q_4 - M$ between u and v if (u, v, M) is admissible configuration. The following lemma serves as a basis of induction in the next section.

Lemma 14 *Let M be a matching in Q_4 and $u, v \in V(Q_4)$. If (u, v, M) is admissible, then there is a Hamiltonian path of $Q_4 - M$ between u and v .*

Proof: If M is aligned, we can use Lemma 7 which holds for every $n \geq 4$. Thus, it remains to consider admissible configurations (u, v, M) only with unaligned matching M .

Assume that (u, v, M) is a maximal admissible configuration, otherwise introduce new edges in M . Notice that with this procedure M stays unaligned. By Lemma 13, the matching M is maximal. Thus $m(M) \in \{2, 3, 4\}$ and M corresponds to one of the matchings in Figures 6-8 by Lemma 12.

Let $d \in [4]$ be a dimension with the maximal number of edges from M , i. e., $|M^d| = m(M)$. Now, as d is fixed, for the sake of simplicity, let us omit d in the notions of Q_L^d, Q_R^d, M_L^d , and M_R^d . Furthermore, for $x \in V(Q_R)$ and $y \in V(Q_L)$ let x_L and y_R denote their corresponding vertices in the opposite subcube, i. e., $x_L = x^d$ and $y_R = y^d$. We say that vertices u and v are *separated* if $u \in V(Q_L)$ and $v \in V(Q_R)$ or vice versa.

In what follows, we distinguish three cases regarding $m(M)$. In each case we consider good/bad configurations in Q_L and Q_R . Then, regarding the position of vertices u and v , we look separately in Q_L and Q_R for paths that can be combined into a Hamiltonian path of $Q_4 - M$ between u and v .

Case 1: $m(M) = 4$. Applying Lemma 9, observe that Figure 20(1)-(5) shows all bad configurations in Q_L or Q_R for each of the five maximal unaligned matchings M with $m(M) = 4$ depicted in Figure 6, respectively. Vertices u and v that form a bad configuration (u, v, M_L) in Q_L or (u, v, M_R) in Q_R are encompassed by a solid elliptic curve, the matching M is represented by dashed edges, whereas other edges of Q_4 are omitted for the sake of clarity. For example, in Figure 20(2) we have two bad configurations in Q_L and two bad configurations in Q_R .

Subcase 1.1: Vertices u and v are separated. Assume that $u \in V(Q_L)$ and $v \in V(Q_R)$. We distinguish the following two possibilities.

1.1.1: M is as in Figure 20(1) and u or v is incident with M^d . By symmetry, we may assume that $u = a$. Observe in Figure 21 that the statement of the lemma holds for each $v \in V(Q_R)$ of different parity than u . The Hamiltonian paths are presented by bold edges.

1.1.2: M is as in Figure 20(2)-(5) or none of u and v is incident with M^d . Let $w \in V(Q_L)$ be a vertex of different parity than u such that it is incident with M_L . Then, v and w^R are also of different parities. Observe in Figure 20(2)-(5) that the vertices w and w^R are in no bad configuration in Q_L and Q_R , respectively. Thus the configurations (u, w, M_L) and (v, w^R, M_R) are good.

Hence there is a Hamiltonian path P_{uw} of $Q_L - M_L$, and a Hamiltonian path P_{w^Rv} of $Q_R - M_R$. The desired Hamiltonian path of $Q_4 - M$ is $P_{uw} + P_{w^Rv}$.

Subcase 1.2: Both vertices u and v are in Q_L . Note that M_L is of size 2, thus denote by e_1, e_2 these two edges. By Lemma 10, there is a Hamiltonian path P_{uv} that either contains precisely one of e_1 and e_2 , or avoids both e_1, e_2 but contains an edge adjacent to both e_1, e_2 . Let $xy \in E(Q_L)$ be that contained edge. Observe in Figure 20(1)-(5) that there is no bad configuration (w, z, M_R) in Q_R such that w_L and z_L are both incident with e_1 or e_2 . Thus the configuration (x_R, y_R, M_R) is good.

Hence there is a Hamiltonian path $P_{x_Ry_R}$ of $Q_R - M_R$. The desired Hamiltonian path of $Q_4 - M$ is $P_{ux} + P_{x_Ry_R} + P_{yv}$ where P_{ux} and P_{yv} are disjoint subpaths of P_{uv} , assuming that x is closer to u on P_{uv} than y .

Subcase 1.3: Both vertices u and v are in Q_R . If M is as in Figure 20(1)-(4), we have symmetry to the previous subcase. However, if M is as in Figure 20(5), then M_R contains only one edge e_1 . Then just put $e_2 = bc$ and proceed symmetrically as in Subcase 1.2.

Case 2: $m(M) = 3$. Applying Lemma 9 observe that Figure 19(1)-(5) shows all bad configurations in Q_L or Q_R for each of the five maximal unaligned matchings M with $m(M) = 3$ depicted in Figure 7, respectively. We consider the following possibilities.

Subcase 2.1: Vertices u and v are separated. Again, assume that $u \in V(Q_L)$ and $v \in V(Q_R)$. We distinguish the following two possibilities.

2.1.1: M is as in Figure 19(1) and u is not incident with M_L . Observe in Figure 22 that for each $u \in V(Q_L)$ that is not incident with M_L , there are spanning paths P_{uw_L} and $P_{b_Lc_L}$ of $Q_4 - M_L$. By Lemma 11, there is a Hamiltonian path P_{wv} of $Q_R + bc$ that contains the edge bc and avoids M_R .

Hence a desired Hamiltonian path of $Q_4 - M$ is $P_{uw_L} + P_{wb} + P_{b_Lc_L} + P_{cv}$ where P_{wb} and P_{cv} are disjoint subpaths of P_{wv} , assuming that b is closer to w on P_{wv} than c .

2.1.2: M is as in Figure 19(2)-(5) or u is incident with M_L . Let $x, y \in V(Q_L)$ be vertices of different parity than u that are incident with M_L . We can always choose such x, y since $|M_L| = 2$. Observe in Figure 19(1) that each bad configuration in Q_L includes at most one vertex incident with M_L . Similarly,

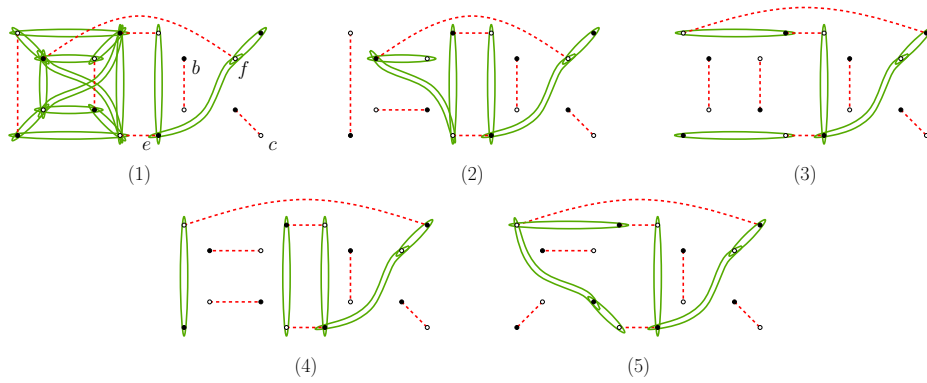

Fig. 19: All bad configurations in Q_L or Q_R for each maximal unaligned matching M in Q_4 with $m(M) = 3$.

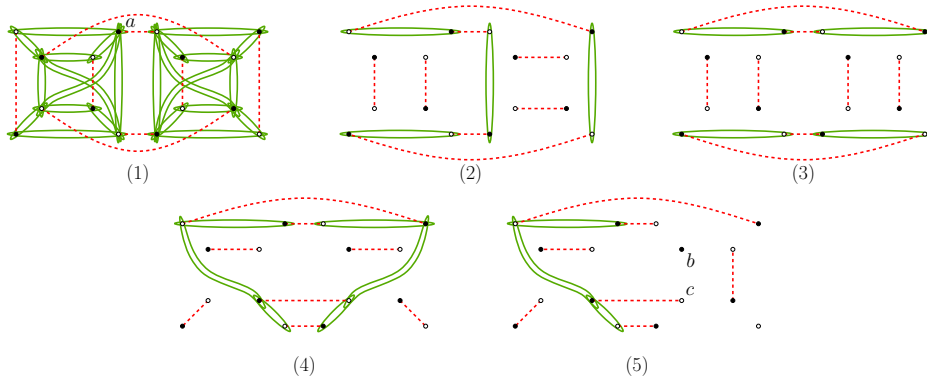

Fig. 20: All bad configurations in Q_L or Q_R for each maximal unaligned matching M in Q_4 with $m(M) = 4$.

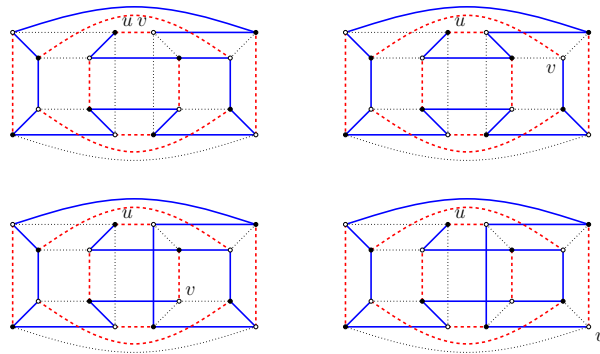

Fig. 21: Hamiltonian paths for Subcase 1.1.1.

observe in Figure 19(2)-(5) that each bad configuration in Q_L includes no vertex incident with M_L . Thus both configurations (u, x, M_L) and (u, y, M_L) are good. Moreover, observe in Figure 19(1)-(5) that for at most one $z \in V(Q_L)$, if z is incident with M_L , then z_R is in a bad configuration in Q_R . Hence at most one of configurations (v, x_R, M_R) and (v, y_R, M_R) is bad. Let $w \in \{x, y\}$ be such that the configuration (v, w_R, M_R) is good.

Therefore, there is a Hamiltonian path P_{uw} of $Q_L - M_L$, and a Hamiltonian path P_{w_Rv} of $Q_R - M_R$. Finally, the desired Hamiltonian path is $P_{uw} + P_{w_Rv}$.

Subcase 2.2: Vertices u and v are both in Q_L or both in Q_R . We distinguish the following two possibilities.

2.2.1: M is as in Figure 19(1) and both u and v are in Q_R . If $\{u, v\} = \{b, c\}$ or $\{u, v\} = \{e, f\}$, observe in Figure 23 that the statement of the lemma holds. Otherwise, by Lemma 11, there is a Hamiltonian path P_{uv} of $Q_R + bc$ that contains the edge bc and avoids M_R . Observe in Figure 19(1) that the configuration (b_L, c_L, M_L) is good.

Thus there is a Hamiltonian path $P_{b_Lc_L}$ of $Q_L - M_L$. The desired Hamiltonian path of $Q_4 - M$ is $P_{ub} + P_{b_Lc_L} + P_{cv}$ where P_{ub} and P_{cv} are disjoint subpaths of P_{uv} , assuming that b is closer to u on P_{uv} than c .

2.2.2: M is as in Figure 19(1) and both u and v are in Q_L , or M is as in Figure 19(2)-(5). We proceed similarly as in Subcase 1.2. Assume that $u, v \in V(Q_L)$, otherwise interchange the roles of Q_L and Q_R . Let $M_L = \{e_1, e_2\}$. By Lemma 10, there is a Hamiltonian path P_{uv} that either contains precisely one of e_1 and e_2 , or avoids both e_1, e_2 but contains an edge adjacent to both e_1, e_2 . Let xy be that contained edge. Observe in Figure 19(1)-(5) that there is no bad configuration (w, z, M_R) in Q_R such that w_L and z_L are both incident with e_1 or e_2 . Thus the configuration (x_R, y_R, M_R) is good.

Hence there is a Hamiltonian path $P_{x_Ry_R}$ of $Q_R - M_R$. The desired Hamiltonian path of $Q_4 - M$ is $P_{ux} + P_{x_Ry_R} + P_{yv}$ where P_{ux} and P_{yv} are disjoint subpaths of P_{uv} , assuming that x is closer to u than y on the path P_{uv} .

Case 3: $m(M) = 2$. Applying Lemma 9 observe that Figure 24(1)-(4) shows all bad configurations in Q_L or Q_R for each of the four maximal unaligned matchings M with $m(M) = 2$ depicted in Figure 8, respectively.

Subcase 3.1: Vertices u and v are separated. Assume that $u \in V(Q_L)$ and $v \in V(Q_R)$. We distinguish the following three possibilities.

3.1.1: M is as in Figure 24(1) and u or v is incident with M^d . Assume that $u = a$, the other case is symmetric. Observe in Figure 25 that the statement holds for each $v \in V(Q_R)$ of different parity than u .

3.1.2: M is as in Figure 24(4) and $\{u, v\} = \{d, e\}$. Observe in Figure 26 that the statement holds.

3.1.3: The remaining possibilities; that is, M is as in Figure 24(1) and none of u and v is incident with M^d , or M is as in Figure 24(2)-(4) and $\{u, v\} \neq \{d, e\}$. A vertex $w \in V(Q_L)$ is free if it has a different parity than u and is not incident with M^d .

We claim that there is a free vertex $w \in V(Q_L)$ such that the configurations (u, w, M_L) and (v, w_R, M_R) are good.

Suppose first that M is as in Figure 24(1)-(3). Observe from the same figure that the configuration (u, x, M_L) is bad for at most one free vertex x . Similarly, the configuration (v, y_R, M_R) is bad for at most one free vertex y . Since there are three free vertices, the claim holds in this case.

Suppose now that M is as in Figure 24(4). If u and d have different parity, then we have two free vertices and both of them satisfy the claim. If u and d have the same parity, we have four free vertices.

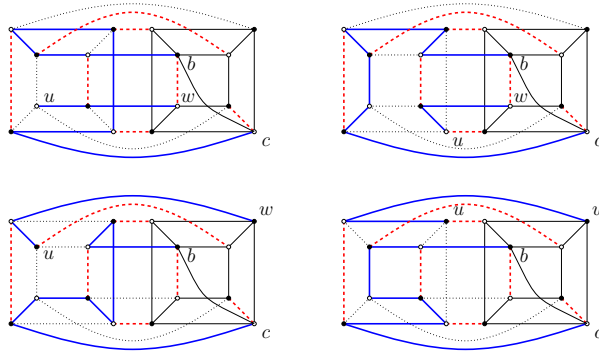

Fig. 22: Spanning paths of Q_L for Subcase 2.1.1.

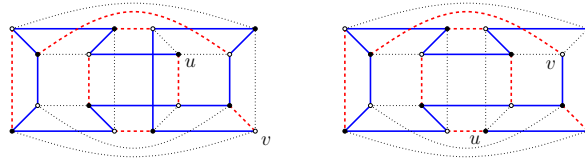

Fig. 23: Hamiltonian paths for Subcase 2.2.1.

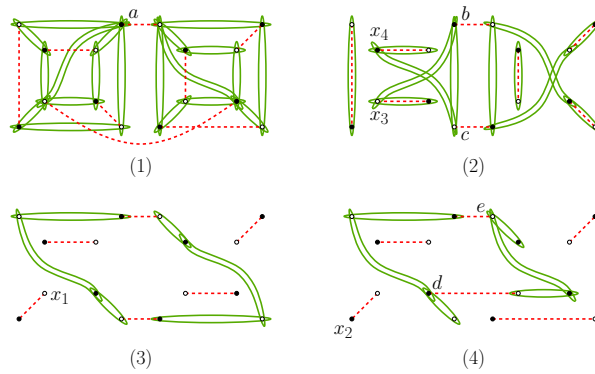

Fig. 24: All bad configurations in Q_L or Q_R for each maximal unaligned matching M in Q_4 with $m(M) = 2$.

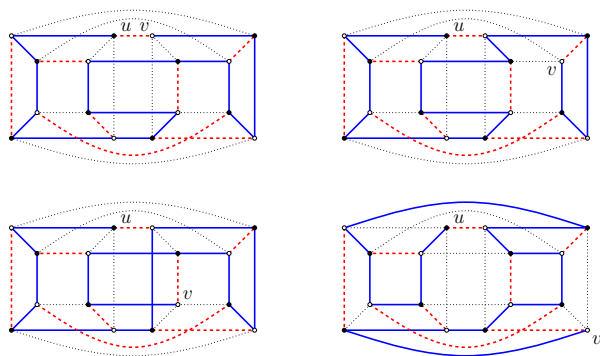

Fig. 25: Hamiltonian paths for Subcase 3.1.1.

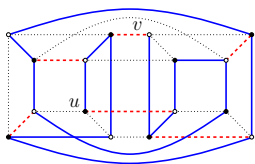

Fig. 26: A Hamiltonian path for Subcase 3.1.2.

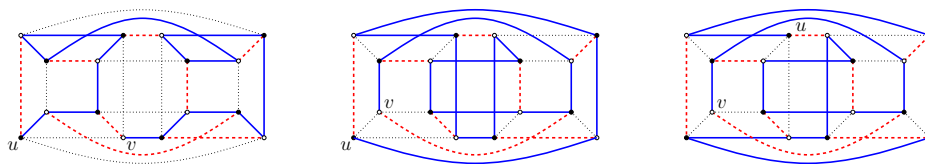

Fig. 27: Hamiltonian paths for Subcase 3.2.1.

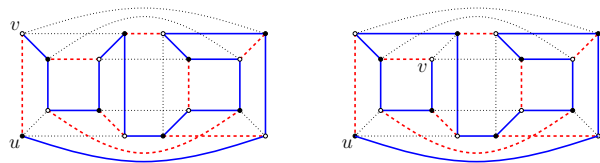

Fig. 28: Hamiltonian paths for Subcase 3.2.2.

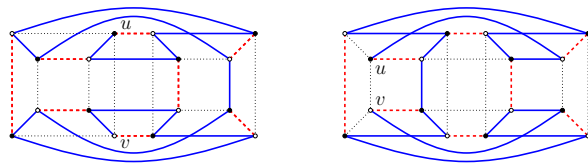

Fig. 29: Hamiltonian paths for Subcase 3.2.3.

Observe in Figure 24(4) that the configurations (u, x, M_L) or (v, x_R, M_R) are bad for at most three free vertices x , since $\{u, v\} \neq \{d, e\}$. Hence the claim holds in all cases.

Therefore, there is a Hamiltonian path P_{uw} of $Q_L - M_L$, and a Hamiltonian path P_{wRv} of $Q_R - M_R$. The desired Hamiltonian path of $Q_4 - M$ is $P_{uw} + P_{wRv}$.

Subcase 3.2: Vertices u and v are both in Q_L or both in Q_R . Assume that $u, v \in V(Q_L)$, the case $u, v \in V(Q_R)$ is symmetric. We distinguish the following five possibilities.

3.2.1: M is as in Figure 24(1) and the configuration (u, v, M_L) is bad. We have three non-isomorphic cases: both, precisely one, or none of u and v is incident with M_L . Observe in Figure 27 that the statement holds for each of these three possibilities.

3.2.2: M is as in Figure 24(1) and the configuration (u, v, M_L) is good. We have two non-isomorphic cases: $uv \in M_L$ and $uv \notin M_L$. Observe in Figure 28 that the statement holds for both of these cases.

3.2.3: M is as in Figure 24(2) and $\{u, v\} = \{b, c\}$ or $\{u, v\} = \{x_3, x_4\}$. Observe in Figure 29 that the statement holds.

3.2.4: M is as in Figure 24(2)-(4), the configuration (u, v, M_L) is good, and $\{u, v\} \neq \{x_3, x_4\}$. Then there is a Hamiltonian path P_{uv} of $Q_L - M_L$.

We claim that P_{uv} contains an edge $xy \in P_{uv}$ such that $xx^R \notin M^d$, $yy^R \notin M^d$, and the configuration (x_R, y_R, M_R) is good.

First, if M is as in Figure 24(3) or 24(4), put $x = x_1$ or $x = x_2$, respectively, and choose y to be any neighbor of x on P_{uv} . Observe in Figure 24(3)-(4) that x is in no bad configuration in Q_L , also x_R is in no bad configuration in Q_R , $xx^R \notin M^d$, and $yy^R \notin M^d$. Thus the claim holds in this situation.

Now M is as in Figure 24(2). Since $\{u, v\} \neq \{x_3, x_4\}$, we have $x_3 \notin \{u, v\}$ or $x_4 \notin \{u, v\}$, say $x_3 \notin \{u, v\}$. Thus the Hamiltonian path P_{uv} contains the edge x_3x_4 . Put $x = x_3$ and $y = x_4$ and observe in Figure 24(2) that the claim is established.

Hence, by the claim, there is a Hamiltonian path $P_{x_Ry_R}$ of $Q_R - M_R$. Finally, the desired Hamiltonian path of $Q_4 - M$ is $P_{ux} + P_{x_Ry_R} + P_{yv}$ where P_{ux} and P_{yv} are disjoint subpaths of P_{uv} , assuming that x is closer to u than y on the path P_{uv} .

3.2.5: The remaining possibility; that is, M is as in Figure 24(2)-(4), the configuration (u, v, M_L) is bad, and $\{u, v\} \neq \{b, c\}$. Choose an edge $xy \in M_L$ such that the configurations $(u, v, M_L \setminus \{xy\})$ and (x_R, y_R, M_R) are good. Observe in Figure 24 and Figure 1 that such an edge exists.

Thus there is a Hamiltonian path $P_{x_Ry_R}$ of $Q_R - M_R$. Since the configuration (u, v, M_L) is bad but the configuration $(u, v, M_L \setminus \{xy\})$ is good, there is a Hamiltonian path P_{uv} that contains edge xy and avoids $M_L \setminus \{xy\}$. The desired Hamiltonian path of $Q_4 - M$ is $P_{ux} + P_{x_Ry_R} + P_{yv}$ where P_{ux} and P_{yv} are disjoint subpaths of P_{uv} , assuming that x is closer to u than y on the path P_{uv} . This completes the proof of the lemma. \square

Acknowledgements

The authors are grateful to the anonymous referee whose constructive comments helped to improve the clarity of this paper.

References

- [1] R. CAHA, V. KOUBEK, *Hamiltonian cycles and paths with a prescribed set of edges in hypercubes and dense sets*, J. Graph Theory, 51-2 (2005), pp. 137–169.
- [2] M. Y. CHAN, S.-J. LEE, *On the existence of Hamiltonian circuits in faulty hypercubes*, SIAM J. Discrete Math., 4 (1991), pp. 511–527.
- [3] T. DVOŘÁK, *Hamiltonian cycles with prescribed edges in hypercubes*, SIAM J. Discrete Math., 19 (2005), pp. 135–144.
- [4] T. DVOŘÁK, P. GREGOR, *Hamiltonian paths with prescribed edges in hypercubes*, Discrete Math., 307 (2007), pp. 1982–1998.
- [5] J. FINK, *Perfect matchings extend to Hamilton cycles in hypercubes*, J. Combin. Theory Ser. B 97 (2007), pp. 1074–1076.
- [6] R. FORCADE, *Smallest maximal matchings in the graph of the d -dimensional cube*, J. Combin. Theory Ser. B, 14 (1973), pp. 153–156.
- [7] F. GRAY, *Pulse Code Communication*, U.S. Patent 2,632,058, filed 13 November 1947, issued 17 March 1953.
- [8] I. HAVEL, *On Hamiltonian circuits and spanning trees of hypercubes*, Čas. Pěst. Mat. 109 (1984), pp. 135–152.
- [9] G. KREWERAS, *Matchings and Hamiltonian cycles on hypercubes*, Bull. Inst. Combin. Appl. 16 (1996), pp. 87–91.
- [10] F. T. LEIGHTON, *Introduction to Parallel Algorithms and Architectures: Arrays, Trees, Hypercubes*, Morgan Kaufmann, San Mateo, CA, 1992.
- [11] M. LEWINTER, W. WIDULSKI, *Hyper-Hamilton laceable and caterpillar-spannable product graphs*, Comput. Math. Appl., 34 (1997), pp. 99–104.
- [12] F. RUSKEY, C. SAVAGE, *Hamilton cycles which extend transposition matchings in Cayley graphs of S_n* , SIAM J. Discrete Math., 6 (1993), pp. 152–166.
- [13] C. SAVAGE, *A survey of combinatorial Gray codes*, SIAM Rev., 39 (1997), pp. 605–629.
- [14] C.-H. TSAI, *Linear array and ring embeddings in conditional faulty hypercubes*, Theor. Comput. Sci., 314 (2004), pp. 431–443.
- [15] C.-H. TSAI, J. J. M. TAN, T. LIANG, L.-H. HSU, *Fault-tolerant Hamiltonian laceability of hypercubes*, Inf. Process. Lett., 83 (2002), pp. 301–306.

