



**HAL**  
open science

# Robust stabilization of thermal behavior for PEM Fuel Cell

Thibaut Raharijaoana, Abdelkrim Salah, Rachid Outbib

► **To cite this version:**

Thibaut Raharijaoana, Abdelkrim Salah, Rachid Outbib. Robust stabilization of thermal behavior for PEM Fuel Cell. International Conference on Renewable Energy: Generation and Applications, Mar 2010, Al Ain, United Arab Emirates. hal-00830225

**HAL Id: hal-00830225**

**<https://inria.hal.science/hal-00830225>**

Submitted on 4 Jun 2013

**HAL** is a multi-disciplinary open access archive for the deposit and dissemination of scientific research documents, whether they are published or not. The documents may come from teaching and research institutions in France or abroad, or from public or private research centers.

L'archive ouverte pluridisciplinaire **HAL**, est destinée au dépôt et à la diffusion de documents scientifiques de niveau recherche, publiés ou non, émanant des établissements d'enseignement et de recherche français ou étrangers, des laboratoires publics ou privés.

# Robust stabilization of thermal behavior for PEM Fuel Cell

Thibaut Raharijaona  
LSIS Laboratory  
Ave. Escadrille Normandie Niemen,  
13 397 Marseille Cedex France  
Telephone: +33 4 91 05 60 23  
Email: thibaut.raharijaona@lsis.org

Abdelkrim Salah  
Email: abdelkrim.salah@lsis.org

Rachid Outbib  
Email: rachid.outbib@lsis.org

**Abstract**—In this study, the control of thermal behavior for Proton Exchange Membrane Fuel Cells (PEMFC) is investigated. A description of the thermal behavior for PEMFC is given thanks to a nonhomogenous bilinear state space representation. In order to perform a local stabilization of the thermal behavior in a convex polytope of parameters, a linear approximation is proposed. Linear Matrix Inequality based results are provided to guarantee that a state-feedback controller ensures local closed loop stability of the temperature behavior whatever the uncertain or known parametric effects in some given set.

## I. INTRODUCTION

Proton exchange membrane fuel cells have attracted great interests as a powerful solution against environment and energy problems. According to the rapid and progressive trend of the related technologies for the production of electric vehicles, it seems certain that fuel cells (FC) will play an important part in public and private transportation systems in the years to come [1]. However, there are many practical problems to be overcome to make this technology economically competitive. Thermal management and minimizing temperature constraints, which add complexity and cost to the system, is one of the most important issues [3]. In addition, the researches are also focused about gases management and water too. We are especially interesting to thermal behavior of FC.

We distinguish two categories of models. In the first one, we use heat equation to describe thermal comportment of FC. Temperature is obtained by solving traditional numerical methods based on approximate solutions to Partial Differential Equations [4]. The most widely used methods are Finite Difference Method, Finite Volume Method and Finite Element Method. Several mathematical models have already been presented to simulate temperature comportment within Fuel Cell [5], [7], [8], [11], [12], [14]. Moreover, these models are not appropriate for the control. The second category of models is based on a global description of the phenomenon [9], [10].

The Nodal Network Method (NNM) is an alternative approach that has been originally inspired by the analogy between electrical circuits and their thermal counterpart's phenomena [13], [15]. This approach inspired by analogical circuit consists in representing heat exchange by their equivalence in electrical supply network in the following manner. At

a first step, the system to be studied is represented by a nodal network (i.e., a network of nodes) and node links are weighted by conductance values depending on the nature of heat exchanges. At a second step, the energy conversion law is applied to define the heat balance associated with each node in the nodal network. As a result, we obtain a state system for each cell together with a thermal conductance associated matrix.

The first contribution of this study is the presentation of an alternative modeling approach to simulate PEMFCs's temperature. We show that thanks to a NNM, the thermal behavior of FC can be represented by a bilinear system. Moreover, the performance of PEMFC is known to be influenced by many parameters [2]. In order to improve fuel cells performance, it is important to consider this parametric effects. For our purpose, we only consider the variation of operating parameters that cannot be modified during the cell utilization. A polytopic representation is one of the most general ways to describe without any conservatism physical parameter uncertainty.

The second contribution of this study proposes a robust stabilization of polytopic systems in order to locally stabilize the temperature for a class of PEMFC. Under the hypothesis of state observability, we design a state-feedback controller for the local robust stabilization in linear matrix inequalities (LMI) region of the uncertain system which belongs to a convex polytope of parameters.

The paper is organized as follows. Section II presents the PEMFC. The state model is described in Section III. The control methodology is detailed in Section IV. Simulations and results are presented in Section V. Finally, concluding remarks and perspectives are given in Section VI.

## II. PEM FUEL CELL

Fuel cells are made up by elementary electrochemical cells called membrane-electrode assembly (MEA). Each elementary cell comprises an electrolyte (i.e., membrane) and two electrodes (i.e., anode and cathode). PEMFC produces electricity via cell reaction from chemical energy stored in fuel. The conversion is accompanied by the production of an important

thermal energy. Fuel oxidation process takes place at the anode:

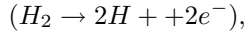

while the reduction process occurs at the cathode:

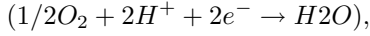

In order to obtain satisfactory tension, unit cells are stacked together in series to make a fuel cell stack. Protons produced by the hydrogen oxidation move across the electrolyte, combine with oxygen and the electrons coming from the external circuit to form water and heat (see Fig. 1):

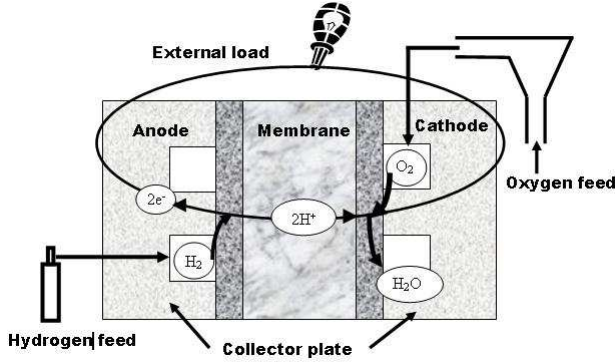
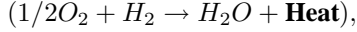

Fig. 1. PEM Fuel Cell

### III. DYNAMIC MODEL OF PEMFC

#### A. Nonlinear model

In the description of a thermal behavior of Fuel Cell, we put a sequence of nodes coupled with the reference node by: heat capacity, linear conductance and generator depending on the potential upstream [15]. Heat flow represents the current and the temperature the tension. Temperature difference between two nodes is represented by conductance  $G$ . The nodal network model is built as follows: node in the bipolar plate coolant channel (side anode and cathode), node in the gases channels (anode and cathode), node in the bipolar plates (part anode and part cathode), node in the electrodes (side anode and cathode), node in the membrane part, node at the inlet and at the outlet side of the fuel cell and node at the entry and at the outlet side of the heat exchanger too (see Fig. 2).

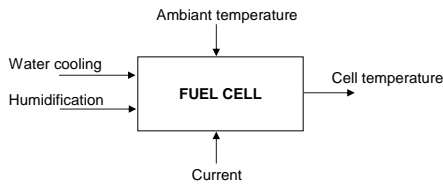

Fig. 2. Control model of PEMFC

1) *Assumptions*: The main assumptions are as follows:

- (H1) Temperature in each cell is homogeneous.
- (H2) Heat resulting by fluid movement is neglected.
- (H3) Exchange between cell and gases are neglected.
- (H4) The heat losses in the manifolds are neglected.

2) *Bilinear model of PEMFC*: The nodal network is built with the assumption that the system can be divided into isothermal blocks (nodes). The temperature change is given by heat flow balance with the neighboring blocks. For example, temperature of each node  $i$  is given by the relationship between its two adjacent nodes  $i + 1$  and  $i - 1$  thanks to the following formula [5], [15]:

$$C_p \frac{dT_i}{dt} = G_{i,i-1}(T_i - T_{i-1}) + G_{i,i+1}(T_i - T_{i+1}) \quad (1)$$

In the set of Eq. (1),  $C_p$  is the global heat capacity associated to node  $i$ ,  $C_p = \rho c S L$ ,  $G$  the thermal conductivity between two nodes.  $S$  is the heat exchange surface,  $L$  the length between the nodes,  $\rho$  the density and  $c$  the specific heat.

Fig. 3 presents the physical interpretation of temperature  $T_i$  introduced in Eq. (1).

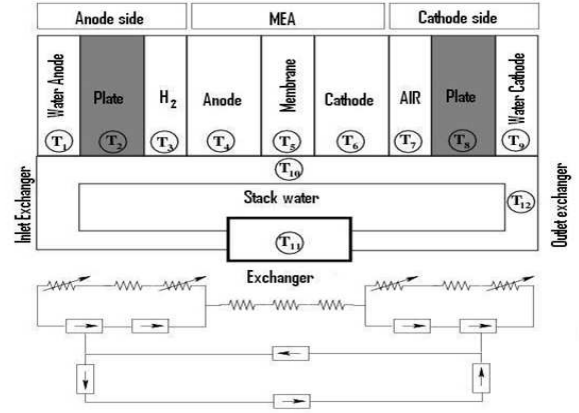

Fig. 3. Temperature  $T_i$  into the control model of PEMFC

Equation (1) can be completed by adjunct of a heat source or a sink  $Q_i$ . Boundary temperatures are introduced through an external conductance  $G_{i,j}^{ref}$  and a reference temperature  $T_k^{ref}$ , so:

$$C_i \frac{dT_i}{dt} = \sum_j G_{i,j}(T_j - T_i) + \sum_k G_{i,j}^{ref}(T_k^{ref} - T_i) + Q_i \quad (2)$$

Finally, one can show that the system described by Eq. (1) can be written in the following form:

$$C\dot{T} = GT + \sum_{i=1}^3 v_i G_i T + Bd \quad (3)$$

where  $T \in \mathbb{R}^{12}$  is the temperature and  $(v_1, v_2, v_3)^T = (\dot{m}_{e,p}, \dot{m}_{e,ec}, \dot{m}_v)^T \in \mathbb{R}^3$  is the control input vector.  $\dot{m}_{e,p}$  is a cell's water rate,  $\dot{m}_{e,ec}$  is an exchanger water rate and  $\dot{m}_v$  is the vapor quantity of humidification.

The matrices  $C$ ,  $G$ ,  $G_i$  and  $B_d$  are not presented in this paper. For a detailed explanation of the nonlinear model, the reader can refer to [6].

Moreover, following a change of variables, one can derive a nonhomogenous bilinear state space representation of the PEMFC thermal behavior around the operating temperature  $T_e$ . Indeed, we consider  $\Delta T$  defined by  $\Delta T = T - T_e$ , the temperature variation for which the system becomes:

$$\dot{\Delta T} = A\Delta T + \sum_{i=1}^3 (u_i B_i \Delta T + b_i) \quad (4)$$

where  $(u_1, u_2, u_3)^T \in \mathbb{R}^3$  is the control input,  $A$  is a 12-by-12 matrix,  $B_i$  is a 12-by-12 matrix and  $b_i$  a 12-by-1 matrix.

### B. Considered model

This study aims at proposing a controller to stabilize the thermal behavior of the PEMFC using a system of water cooling exchanger as an input control. The strategy must take into account water flows and eventually the quantity of vapor brought by humidification of gases.

The local stabilization around an operating temperature is proposed for a class of PEMFC in a given set of parameters thanks to the following proposition.

*Proposition 1:* If the pair  $(A, [b_1, b_2, b_3])$  of the system described by Eq. (4) is controllable, then the bilinear system can be made locally asymptotically stable around the origin.

The control methodology presented in the following is based on the proposition 1. A state-feedback controller with pole placement constraints against the internal physical parameters is computed. The closed-loop poles can be forced into some sector of the stable half-plane to obtain specified responses. The problem consists in a convex optimization involving linear matrix inequalities (LMIs).

## IV. CONTROL METHODOLOGY

From the linear approximation of Eq. (4) around an operating temperature  $T_e$ , one can define the following state space representation:

$$\begin{cases} \dot{x} = A(\theta)x(t) + B(\theta)u(t) + B_w(\theta)w(t) \\ y(t) = C_y(\theta)x(t) \\ z(t) = C_z(\theta)x(t) \end{cases} \quad (5)$$

The state vector  $x \in \mathbb{R}^{12}$  stands for the temperature variation  $\Delta T$ .  $B(\theta) = B_w(\theta) = (b_1, b_2, b_3)$ .  $u(t) \in \mathbb{R}^3$  is the control input vector.  $y(t)$  is the measured output vector and  $z(t)$  is the regulated output vector which corresponds to  $\Delta T$  in the application.  $\theta$  is the vector of parameters which is detailed in the following. The generalized plant is presented on Fig. 4.

### A. Parametrization of the polytopic system

In this study, we consider a class of 10kW PEMFC and we assume that its dimension depends on the surface of the membrane. The membrane is supposed to be rectangular whose  $h_m$  is the height and  $L_m$  is the length. According to the

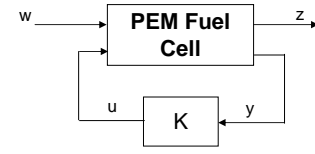

Fig. 4. Generalized plant

literature [16], [17], we also assume that the power  $Q$  depends on the surface of the membrane. For a  $1\text{cm}^2$  active surface, the PEMFC generates  $1\text{W}$ . Moreover, the following relation can be written:

$$Q = \alpha L_m h_m \quad (6)$$

where  $Q$  is the power of the PEMFC.

Consequently, we define the vector of parameters  $\theta$  such that:

$$\theta = (N, L_m, h_m) \quad (7)$$

where  $N$  is the number of fuel cells in series.

In order to build the vertices of the polytopic system for a 10kW PEMFC, we represent in Fig. 5 thanks to the points whose the coordinates are given by  $(L_m, N)$ , the feasible configurations for a fixed value of the height  $h_m = 0.1$  meter. The points are interpolated by solid lines.

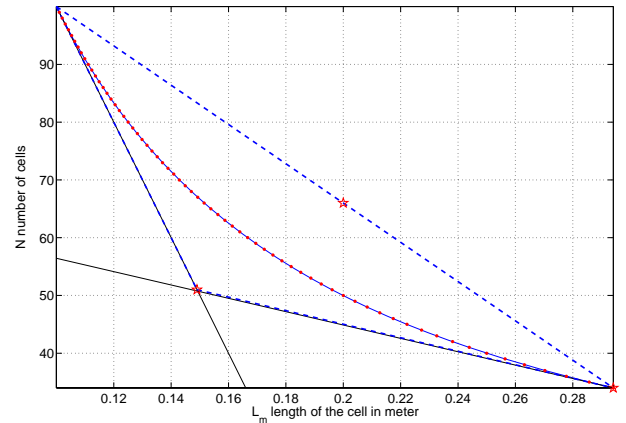

Fig. 5. Vertices of the polytopic system for the parameters  $N$  et  $L_m$ .

For the seek of simplicity, the parameter  $h_m$  is fixed such that  $h_m = 0.1$  meter. Consequently, the vector of physical varying parameter  $\theta$  is  $\theta = (L_m, N)$ . From the convex polytope drawn in dotted lines in Fig. 5, we define in Table I, the vertices of the polytopic system. On can remark that each vertex corresponds to a feasible PEMFC with the constraint that  $L_m \in [0.1; 0.3]$ . The vertices  $\theta_1 = (0.29, 34)$  and  $\theta_4 = (0.1, 100)$  stands for 10kW PEMFCs.

TABLE I  
COORDINATES OF THE VERTICES OF THE POLYTOPIC SYSTEM

N	34	51	66	100
$L_m$ in meter	0.29	0.20	0.14	0.1

## B. Control objectives

The critical aspect of the conduction in the PEMFC is the variation of temperature into the fuel cells. In practice, the membrane cannot tolerate a high peak of local temperature (max 100 degrees Celsius). For this reason, a robust local stabilization of the temperature is investigated. The control objectives are formulated such that:

- The closed-loop polytopic system defined by Eq. (4) and the state-feedback  $u = K\Delta T$  is locally stable.
- The  $H_2$  norm of the transfer functions (from Eq. (5))  $T_{w \rightarrow z}$  is minimum.
- The closed-loop poles are in a prescribed region  $\mathbf{D}$  of the open left-half plane.

Our design objectives have the following LMI formulation.

## C. Convex optimization in LMI region

The design problem of the application presented in this paper consists of computing a state-feedback controller that minimizes a  $H_2$  norm constraint for a set of vertices that define a convex polytope [19], [20].

Defining the variables  $W = W^T$ ,  $Y = Y^T = P$  and  $L = KP$ , it is possible using the Schur's complement to formulate the problem as an LMI problem:

$$\min_{\{Y, L\}} \text{trace}(W) \quad (8)$$

$$AY + YA^T + B_u L + L^T B_u^T + B_w B_w^T \leq 0 \quad (9)$$

$$\begin{pmatrix} Y & Y C_z^T \\ C_z Y & W \end{pmatrix} \geq 0 \quad (10)$$

Moreover, in order to take into account regional pole constraints, it is interesting to design the control  $K$  such that the closed loop poles of  $(A + B_u K)$  lie in a suitable sub-region of the complex left-half plane. This region for control purposes, as shown on Fig. 6, is the set  $\mathbf{S}(\alpha, r, \beta)$  of the complex number  $x + jy$  such that:

$$x < -\alpha < 0, \quad |x + jy| < r \text{ and } \tan(\beta)x < -|y| \quad (11)$$

Confining the closed loop poles in this region ensures a

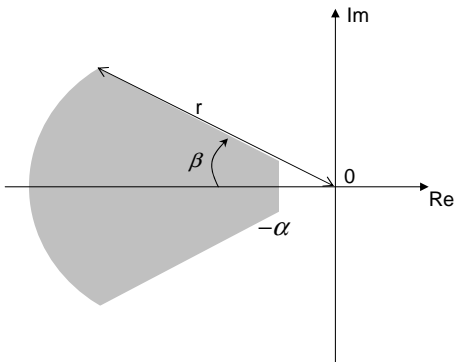

Fig. 6. Region  $\mathbf{S}(\alpha, r, \beta)$

decay rate  $\alpha$ , a minimum damping ratio  $\zeta = \cos(\beta)$  and a minimum undamped frequency  $\omega_d = \sin(\beta)$  ( $\beta$  in radian). The LMI formulations for the poles of  $(A + B_u K)$  in the region  $\mathbf{S}(\alpha, r, \beta)$  are characterized as the following LMIs: If there exists symmetric  $P > 0$ , with  $L = KP$  and  $Y = P$  such that:

$$N(Y, L) + N^T(Y, L) + 2\alpha Y < 0 \quad (12)$$

$$\begin{pmatrix} -rY & N(Y, L) \\ N^T(Y, L) & -rY \end{pmatrix} < 0 \quad (13)$$

$$\begin{pmatrix} s(\beta)(N(Y, L) + N^T(Y, L)) & c(\beta)(N(Y, L) - N^T(Y, L)) \\ -c(\beta)(N(Y, L) - N^T(Y, L)) & s(\beta)(N(Y, L) + N^T(Y, L)) \end{pmatrix} < 0 \quad (14)$$

where  $N(Y, L) = AY + B_u L$ ,  $s(\cdot) = \sin(\cdot)$  and  $c(\cdot) = \cos(\cdot)$ . Consequently, if there exists matrices  $Y$  and  $L$  for (12)-(14), then the poles of  $(A + B_u K)$  lie in the region  $\mathbf{S}(\alpha, r, \beta)$ .

In this paper, we aim at finding a state-feedback gain  $K$  that locally stabilizes the polytopic system defined by Eq. (4). The combination objectives of robust  $H_2$  control with regional pole constraints can be characterized for  $W = W^T$  as follows:

$$\min_{\{Y, L\}} \text{trace}(W) \quad (15)$$

such that for  $i = 1, \dots, 4$ :

$$N_i(Y, L) + N_i^T(Y, L) + B_{w,i} B_{w,i}^T \leq 0 \quad (16)$$

$$\begin{pmatrix} Y & Y C_{z,i}^T \\ C_{z,i} Y & W \end{pmatrix} \geq 0 \quad (17)$$

$$N_i(Y, L) + N_i^T(Y, L) + 2\alpha Y < 0 \quad (18)$$

$$\begin{pmatrix} -rY & N_i(Y, L) \\ N_i^T(Y, L) & -rY \end{pmatrix} < 0 \quad (19)$$

$$\begin{pmatrix} s(\beta)(N_i(Y, L) + N_i^T(Y, L)) & c(\beta)(N_i(Y, L) - N_i^T(Y, L)) \\ -c(\beta)(N_i(Y, L) - N_i^T(Y, L)) & s(\beta)(N_i(Y, L) + N_i^T(Y, L)) \end{pmatrix} < 0 \quad (20)$$

In this study, the most important task is to find the variable  $Y$  and  $L$ . Once a feasible solution  $(Y, L)$  of Eq. (15) is computed, the state feedback gain matrix  $K$  is synthesized as  $K = LY^{-1}$ .

## V. SIMULATION RESULTS

In this section, the performance and stability of the robust controller for the local stabilization of the temperature behavior for a class of 10kW PEMFC are presented by math simulations. The above LMI problem (16)-(20) is solved using YALMIP [18] with SeDuMi [21].

### A. Local temperature stabilization for a class of PEMCF

In order to locally control the gradient of temperature in various points of the stack, the nonhomogenous bilinear state space Eq. (4) is used to validate the obtained results.

Assuming the operating temperature of PEMFC is  $T_e = 80^\circ C$ , we chose the parameter values  $L_m$  and  $N$  which are included in the convex polytope defined by the vertices in Table I such that  $L_m = 0.16m$ ,  $h_m = 0.1m$  and  $N = 66$ , thus  $Q = 10560W$ . Placing the closed-loop poles in the region shown in Fig. 6 is to guarantee some minimum decay rate and closed-loop damping. We specify the LMI region for the pole placement as the set  $\mathbf{S}(\alpha, r, \beta)$  where the decay rate  $\alpha = 0.01$ ,  $\beta = \frac{\pi}{4}$  for a minimum damping ratio  $\zeta = \cos(\beta) = 0.707$  and  $r = 10^4$ .

We consider in the paper a class of 10kW PEMCF such that the tolerated temperature gradient is 1 degree Celsius especially for the membrane. For the state  $\Delta T$ , the initial conditions  $\Delta T_{0,i}$  are supposed as:

For the membrane  $\Delta T_{0,5} = 0.5^\circ C$ , for the solid part of the PEMFC  $\Delta T_{0,\{2,4,6,8\}} = 0.3^\circ C$ , for the liquid part  $\Delta T_{0,\{1,9,10,11,12\}} = 0.3^\circ C$  and for the fluid part of oxygen and hydrogen at the anode and cathode  $\Delta T_{0,\{3,7\}} = 0.2^\circ C$ .

The following simulations demonstrates the effectiveness of the controller with regional pole placement. We compare for each figure the result of the local stabilization of temperature with the nonhomogenous bilinear representation of the PEMFC to the linearized model for parameter configuration which belongs to the convex polytope on Fig. 5.

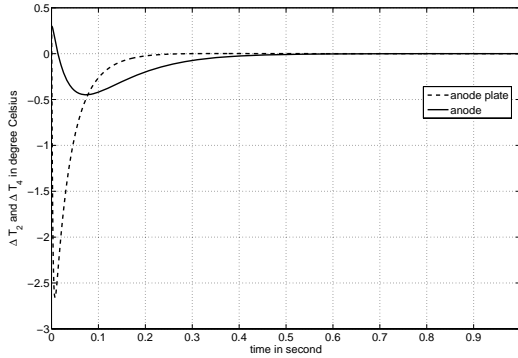

Fig. 7.  $\Delta T$  versus time in the anode side

Figures 7-11 present the locally regulated temperature variation  $\Delta T$  in various points of the stack. Particularly on Fig. 8, one can remark that the gradient of temperature within the membrane decreases to zero in 0.5 second. The responses of the nonhomogenous bilinear and the linearized systems are similar. Consequently, the membrane is protected from high gradient in these operating conditions.

From Fig. 10, the time responses for the temperature variations of gases are smaller than those in the cathode side on Fig. 9. This result is due to the difference of the specific heat constants between the liquid and gaseous phases in the membrane-electrode assembly and the cathode side. Fig. 11 presents

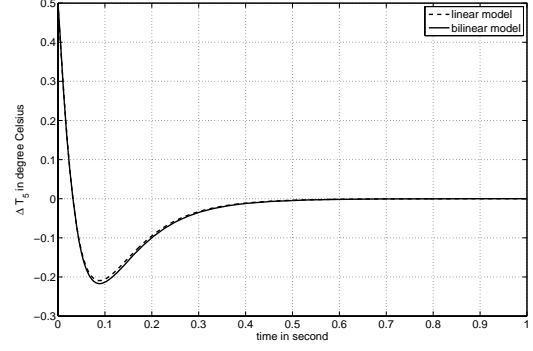

Fig. 8.  $\Delta T$  versus time within the membrane

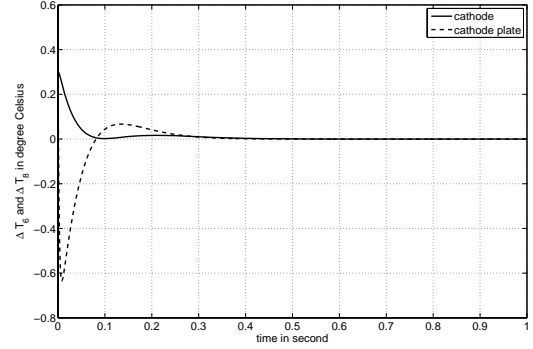

Fig. 9.  $\Delta T$  versus time in the cathode side

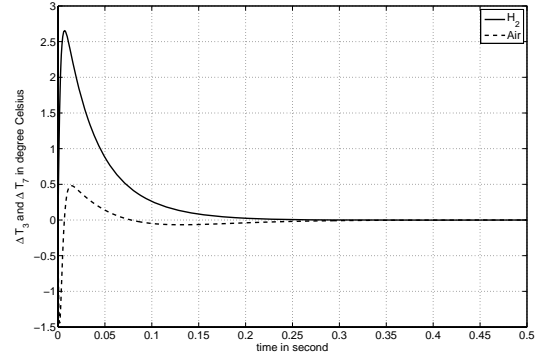

Fig. 10.  $\Delta T$  versus time of gases

the temperature variations in the exchanger and the outlet exchanger. The exchanger aims at cooling the water that is coherent with the result so obtained. Moreover, the closed-loop poles of the linearized model in the convex polytope are collected in Table II.

In this case, the damping ratio  $\zeta = 0.901 > 0.707$ . Consequently, the damping ratio specification is met.

## VI. CONCLUSION AND PERSPECTIVES

An Nodal Network Method model for the thermal behavior of PEMFC has been proposed. A nonhomogenous

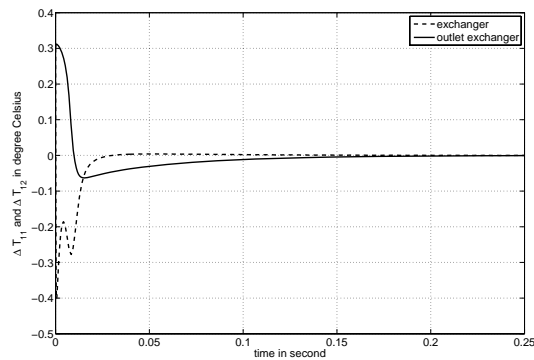

Fig. 11.  $\Delta T$  versus time of the water cooling

TABLE II  
CLOSED-LOOP POLES OF THE LINEARIZED MODEL IN THE CONVEX  
POLYTOPE

$n^o$	closed-loop poles
1	-4780.2
2	-2963.2
3	-666.3
4	-422
5	-119.9
6	-44.2
7	$-20.3+9.7i$
8	$-20.3-9.7i$
9	-28.2
10	-6.1
11	-10.8
12	-19.7

bilinear state-space representation of the temperature variation of PEMFC is presented. Moreover, the problem of local stabilization of the system is addressed. A robust control technique for a class of 10kW PEMFC which is based on the minimization of  $H_2$  norm constraint thanks to a state-feedback with regional pole placement is investigated.

Simulation results verify that the proposed controller can guarantee local stabilization of a set of PEMFC included in the convex polytope. The presented solution is a first approach in the control taking into account *a priori* known operating variables such as the number of cells  $N$ , the length  $L_m$  and the height  $h_m$  and can tolerate uncertainties of these parameters. As perspectives, one can test the control method under disturbances and enlarge the dimension of the polytope with pertinent parameters. Nevertheless, a numerical solution to the optimization problem may not be ensured. The next study should also concern the control design under the constraints of input saturations and time responses specifications of the solid, liquid and gaseous parts of the PEMFC.

## REFERENCES

[1] M.R. Von Spakovsky and al., Multi inter-disciplinary approach to fuel cell system development, *Future Car Congress, paper- 00FCC- 10*, Virginia, 2000.

[2] L. Wang, A. Husar, T. Zhou and H. Liu, A parametric study of PEM fuel cell performances, *Int J. Hydrogen Energy* volume 11, pp. 12631272,2003.

[3] C. Bernay, M. Marchant and M. Cassir, Prospect of diferent fuel cell technologies for vehicle applications, *J. Power sources*, volume 108, pp. 139-152, 2002.

[4] Y. Shan, S.Y. Choe, Modeling and simulation of a PEM fuel cell stack considering temperature effects, *J. Power Sources*, Vol. 158, pp. 274-286, 2006.

[5] L. Dumercy, Contribution la caractérisation thermique et fluïdique d'une pile combustible membrane échangeuse de protons (PEMFC), Ph.D. Thesis, *University of Technology of Belfort-Montbéliard (UTBM)*, France, 2004.

[6] A. Salah, Simulation et contrôle de l'aspect thermique d'une pile à combustible PEMFC, Ph.D. Thesis, *University of Technology of Belfort-Montbéliard (UTBM)*, France, 2008.

[7] A. Salah, O. Serres, J. Gaber, R. Outbib and H. El-Sayed, Parallel simulation of fuel cell thermal behavior with UPC, in *Proc. IEEE international conference on signal processing and communications*, Dubai, 2007.

[8] A. Salah, J. Gaber and R. Outbib, Numerical simulation of PEM fuel cell thermal behavior by a global nodal network model, in *Proc. Conference on systems and control*, Morocco, 2007.

[9] R. Saisset, Contribution l'étude systmique de dispositifs nergtiques composants lectrochimiques, *Ph.D. Thesis, INP toulouse*, France, 2004.

[10] J. Lachaise, Etude des stratgies et des structures de commande pour le pilotage des systmes nergtiques Pile Combustible (PAC) destins la traction, *Ph.D. Thesis, INP Toulouse*, France, 2004.

[11] N. Djilali, and D. Lu, Influence of heat transfer on gas and water transport in fuel cells, *Inter. J. Therm. Sci.*, 41, 2002.

[12] N. Djilali, Computational fuel cell engineering-challenges and opportunities, *ECOS, Thronheim*, 2005.

[13] S. Litster, J.G. Pharoah, G. McLeana and N. Djilali, Computational analysis of heat and mass transfer in a micro-structured PEMFC cathode, *J. Power Sources*, vol. 156,  $n_o2$ , pp. 334-344, 2006.

[14] J. Ramousse and al., Modeling of heat, mass and charge transfer in single Cell, *J. Power Sources*, 145, pp. 416-427, 2005.

[15] J.B. Saulnier, La modlisation thermique et ses applications aux transferts coupls et au contrle actif. Phd Thesis, *Poitiers University*, France, 1980.

[16] J. Larminie and A. Dicks, *Fuel Cell Explained*, Wiley Ed., 2000.

[17] C. Bonnet, S. Didierjean, N. Guillet, S. Besse and T. Colinart, Design of an 80 kW Fuel Cell system: Scale Up Effect investigation, *J. Power Sources*, vol. 182, pp. 441-448, 2008.

[18] J. Lofberg, YALMIP: A toolbox for modeling and optimization in MATLAB, *CACSD Conference*, 2004.

[19] M. Chilali, P. Gahinet,  $H_\infty$  design with pole placement constraints: an LMI approach. *IEEE Transactions on Automatic Control*, vol. 41 number 3, pp. 358367, 1996.

[20] C. Scherer, P. Gahinet and M. Chilali, Multiobjective output-feedback control via LMI optimization. *IEEE Transactions on Automatic Control*, vol 42 number 7, pp. 896911,1997.

[21] J.F. Sturm, Using SeDuMi 1.02, a Matlab toolbox for optimization over symmetric cones, *Optimization Methods and Software*, vol 11, pp. 625-653, 1999.