

Systematizing tuning of computer systems using crowdsourcing and statistics

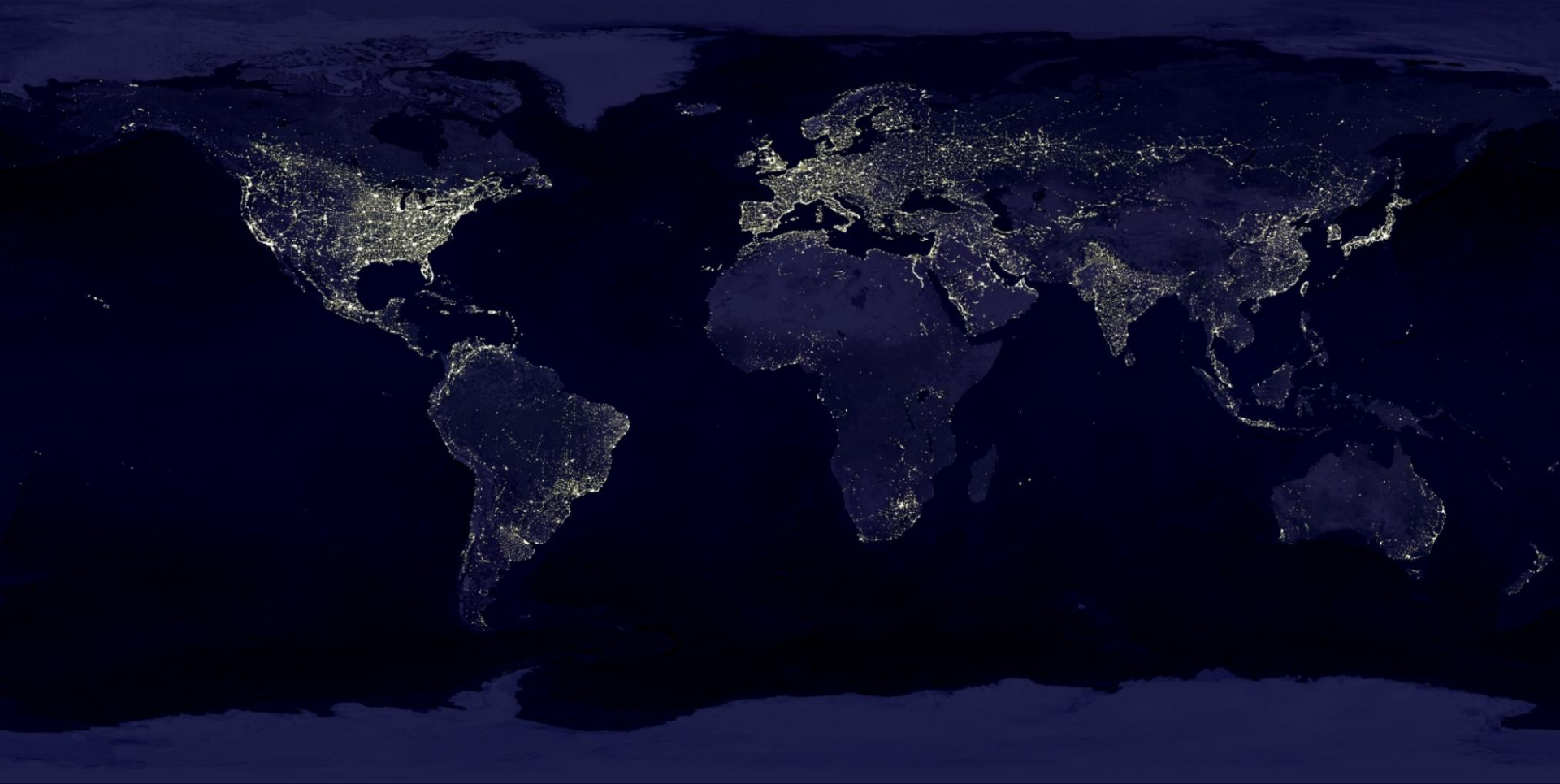

Grigori Fursin
INRIA, France

HPSC 2013, Taiwan
March 2013

Messages

1st talk (Wednesday)

Systematizing tuning of computer systems
using crowdsourcing and statistics

- *Revisiting current design and optimization methodology*
- *Leveraging experience and computer resources of multiple users*
- *Using predictive modelling and data mining to improve computer systems*

2nd talk (Friday)

Collective Mind: novel methodology, framework
and repository to crowdsource auto-tuning

- *New plugin-based extensible infrastructure and repository for collaborative analysis and tuning of computer systems - will be released in May 2013*
- *“Big data” enables cooperation between architecture, compiler, OS and application designers and mathematicians*
- *Examples of auto-tuning and predictive modeling for numerical kernels*

Motivation: back to 1993

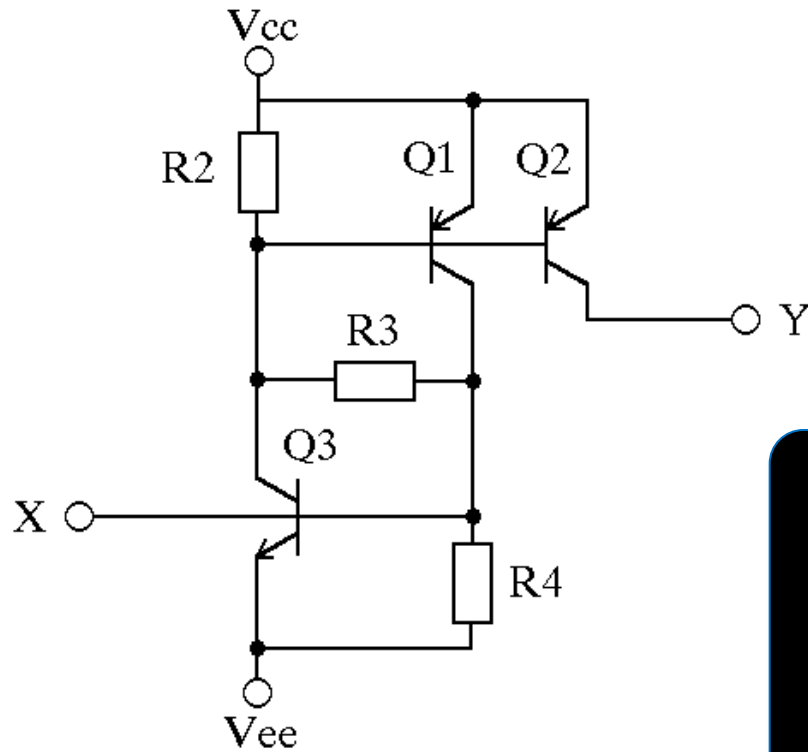

Semiconductor neural element -
possible base of neural computers

Modeling and understanding
brain functions

- **Slow**
- **Unreliable**
- **Costly**

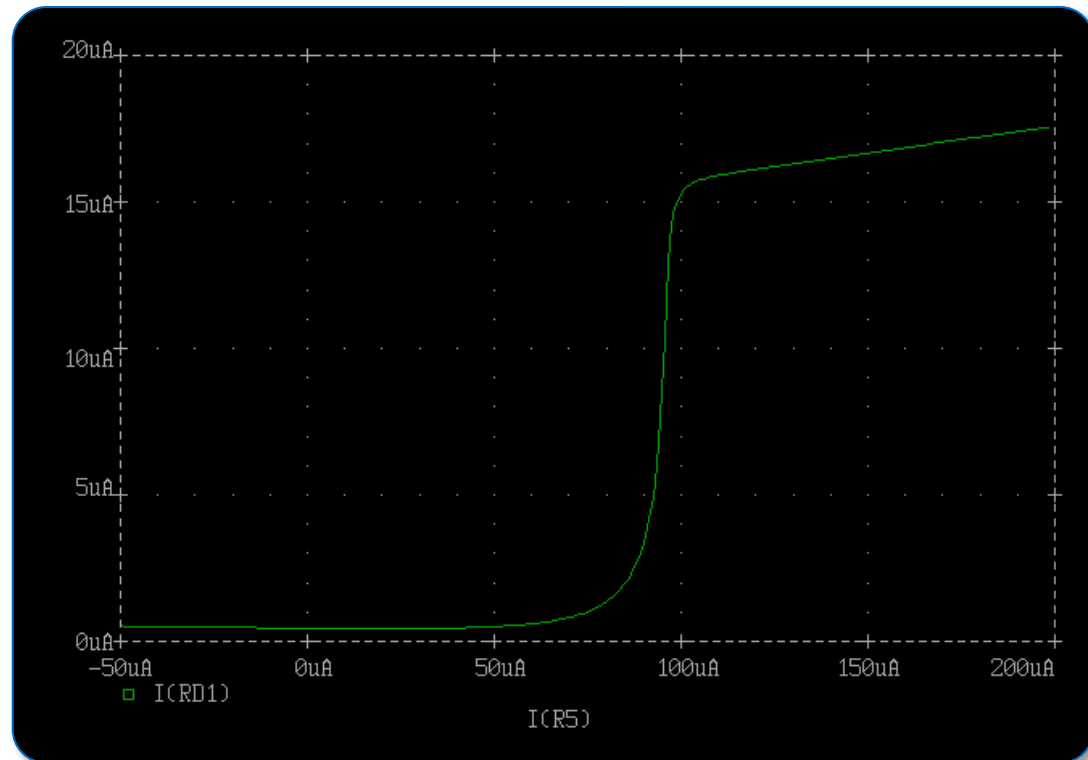

Motivation: back to basics

End users



Task

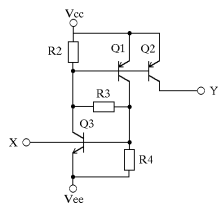

Solution

User requirements:

most common:

*minimize all costs
(time, power consumption,
price, size, faults, etc)*

*guarantee real-time constraints
(bandwidth, QOS, etc)*

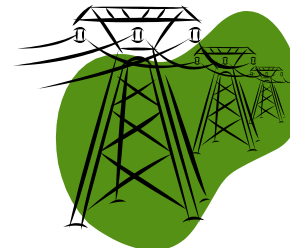

Result

Motivation: back to basics

End users

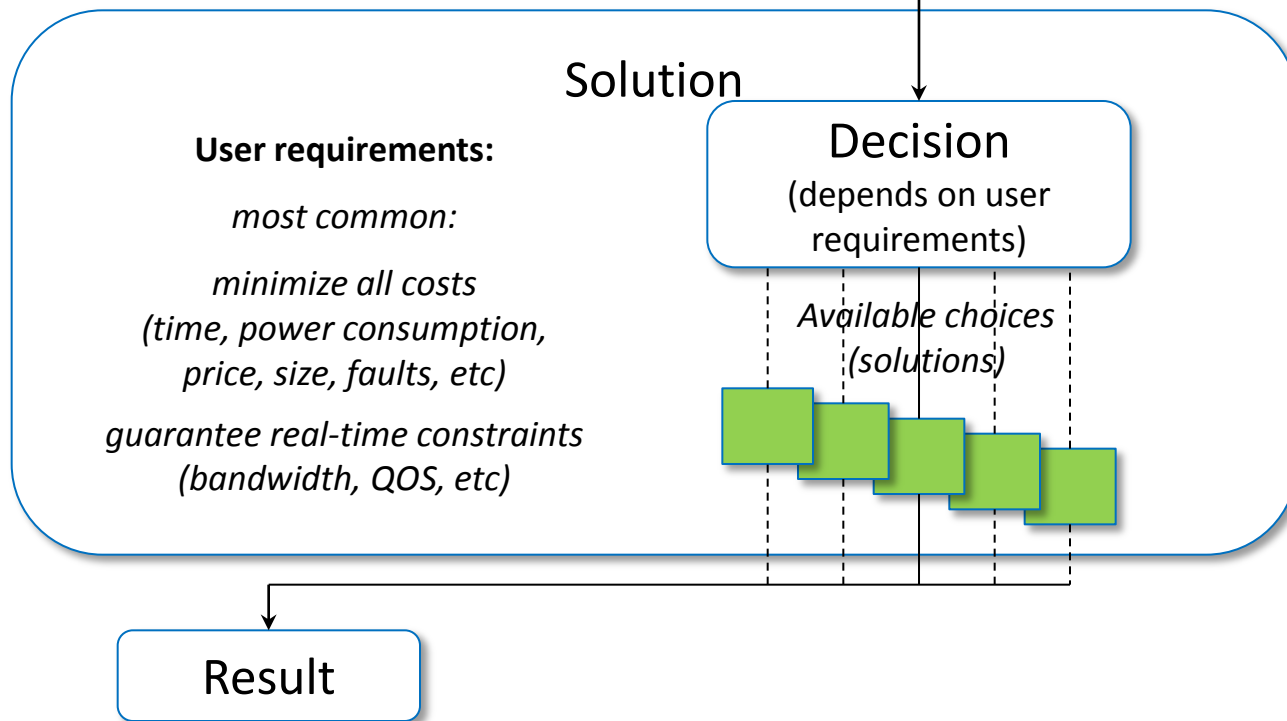
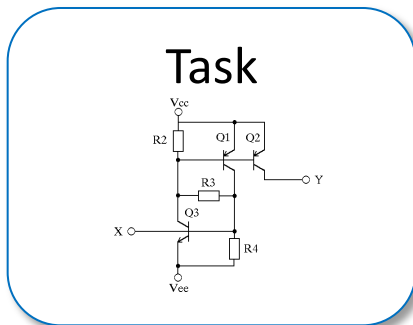

Result

Motivation: back to basics

End users

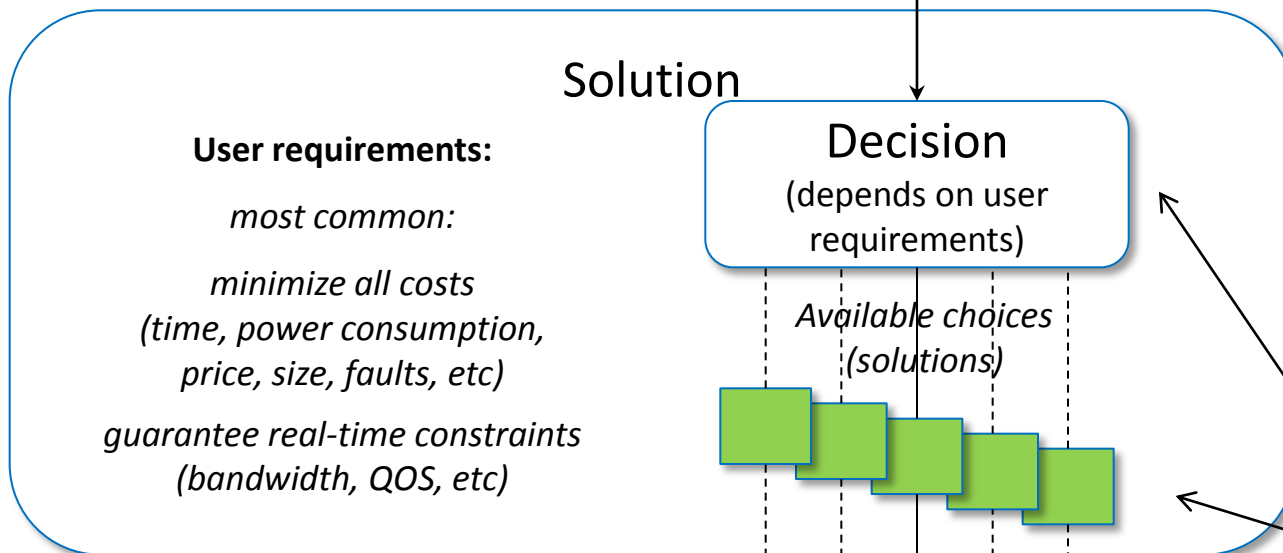
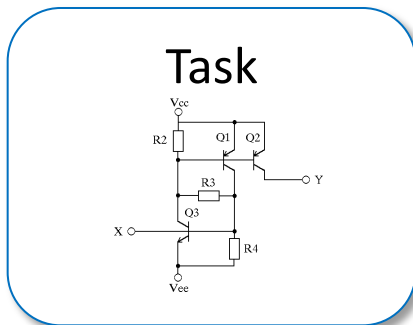

Should provide choices and help with decisions

Hardware and software designers

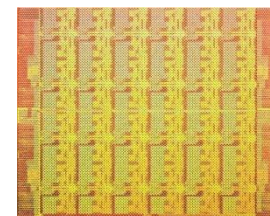

Result

Motivation: back to basics

End users

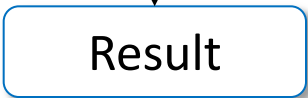
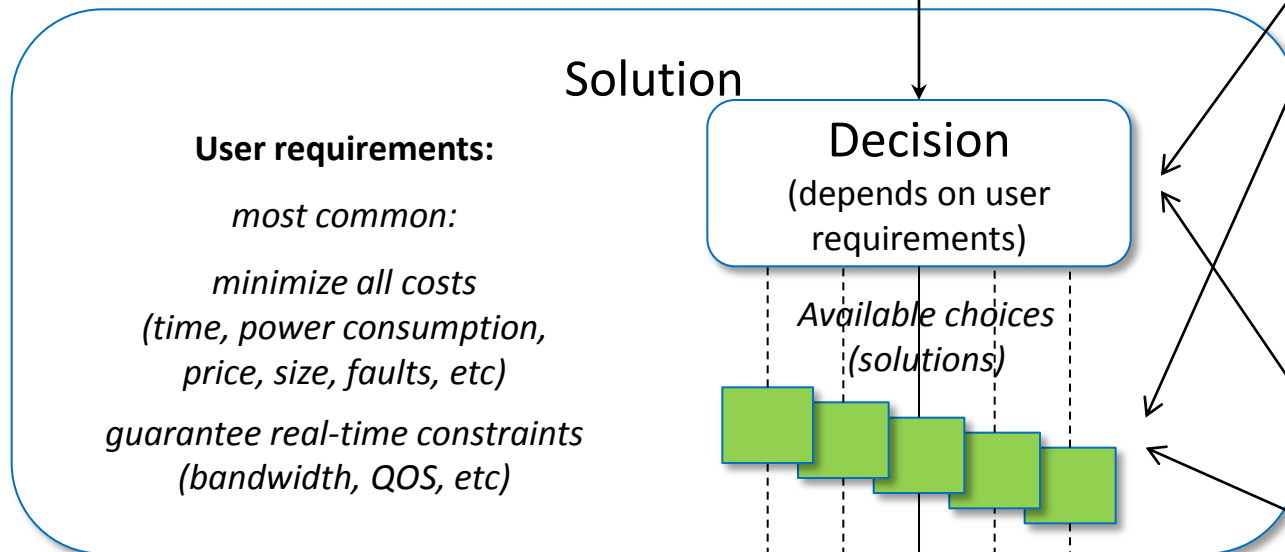
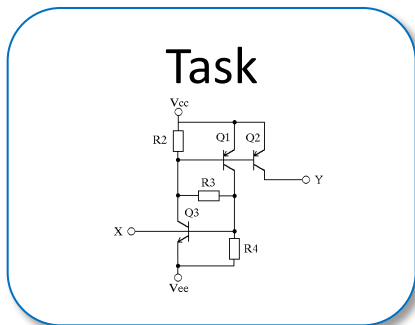

Service/application providers

(supercomputing, cloud computing, mobile systems)

Should provide choices and help with decisions

Hardware and software designers

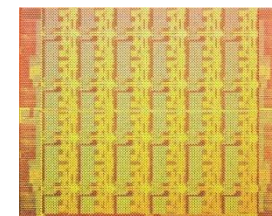

Available solutions: hardware

Companies compete hard to deliver many solutions with various characteristics: *performance, power consumption, size, bandwidth, response time, reliability, cost ...*



Available solutions: software

Software developers try to keep pace and produce various algorithms, programming models, languages, analysis tools, compilers, run-time systems, databases, etc.

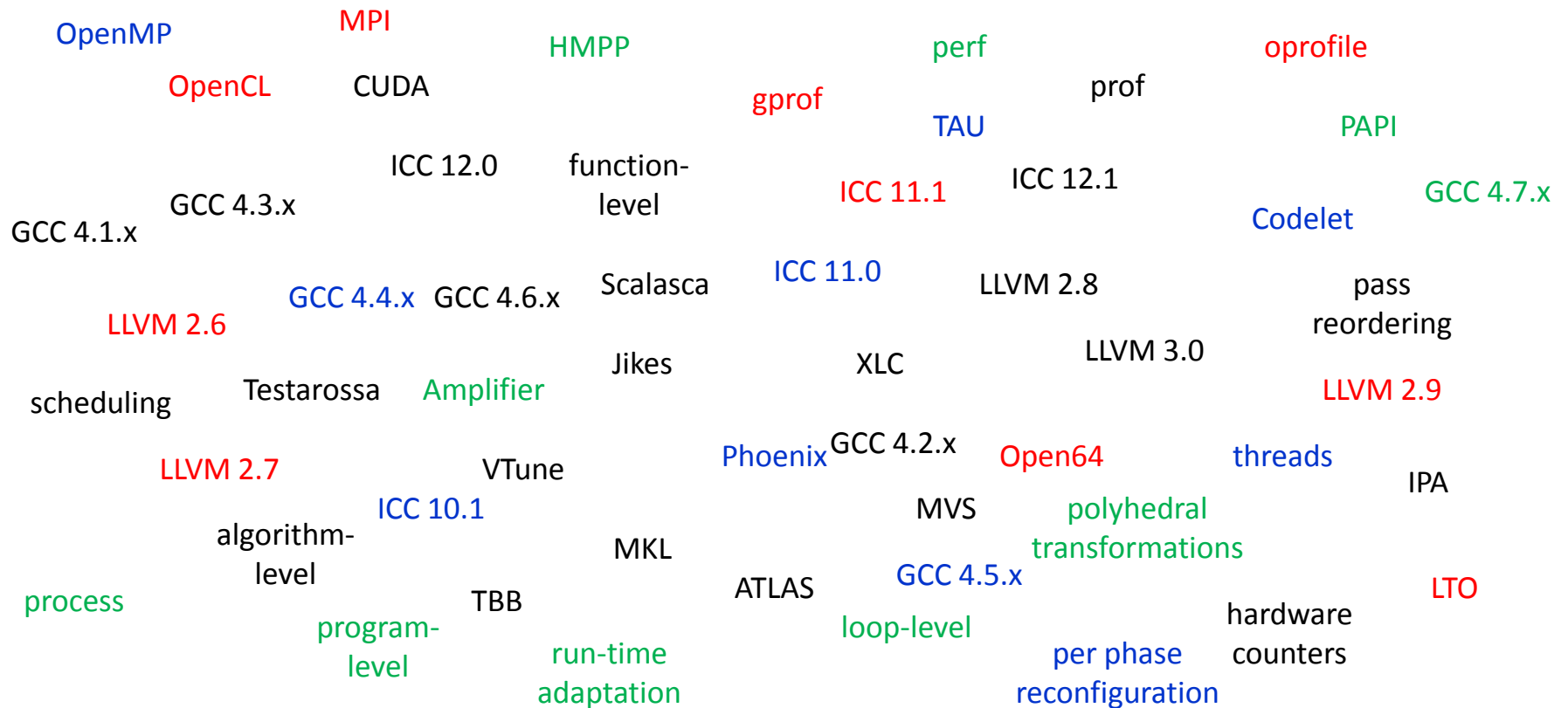

Challenges

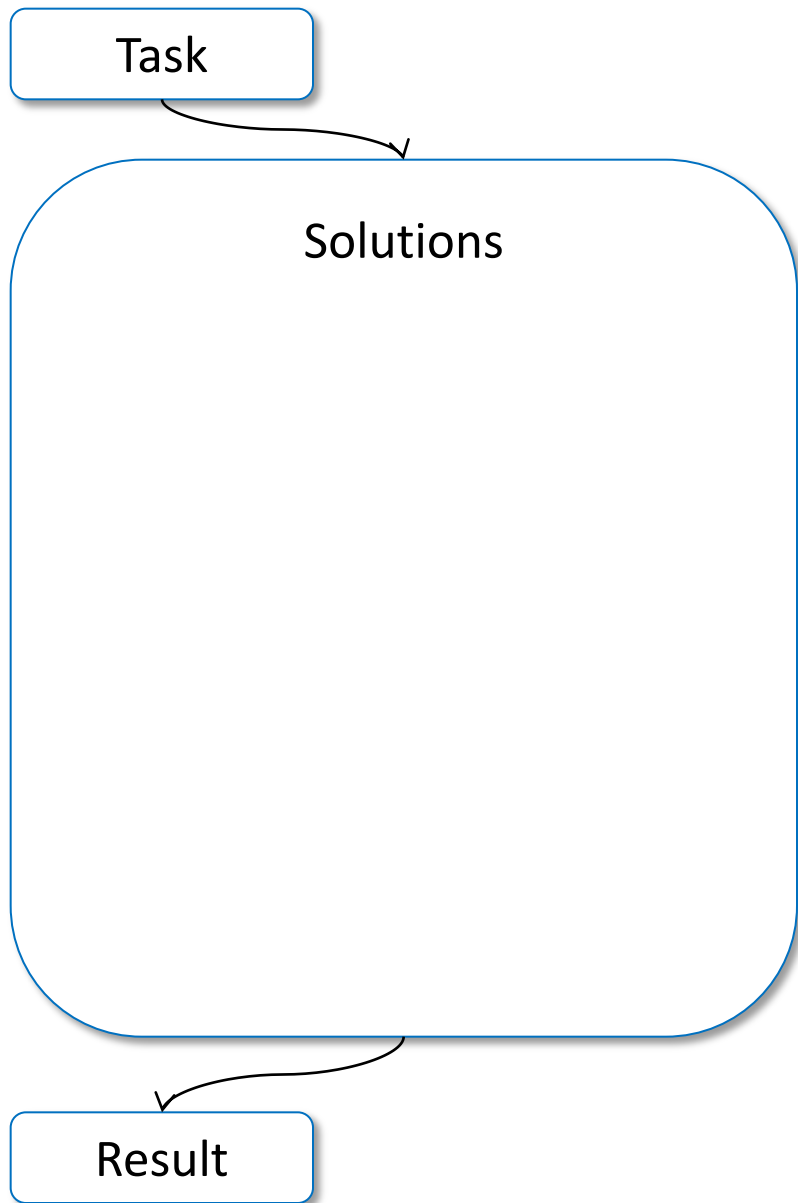

Challenges

Result:

- finding the right solution for end-user is extremely challenging
- everyone is lost in choices
- dramatic increase in development time
- low ROI
- underperforming systems
- waste of energy
- ad-hoc, repetitive and error-prone manual tuning
- **slowing innovation in science and technology**

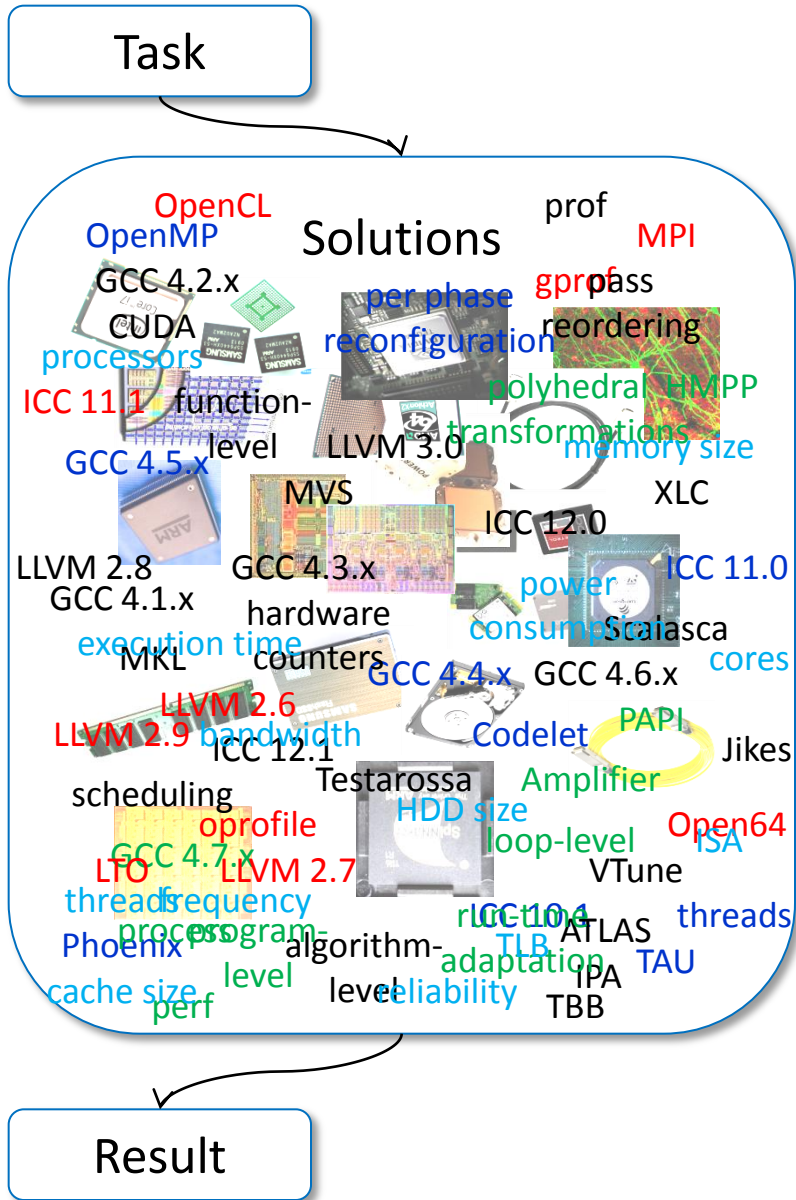

Challenges

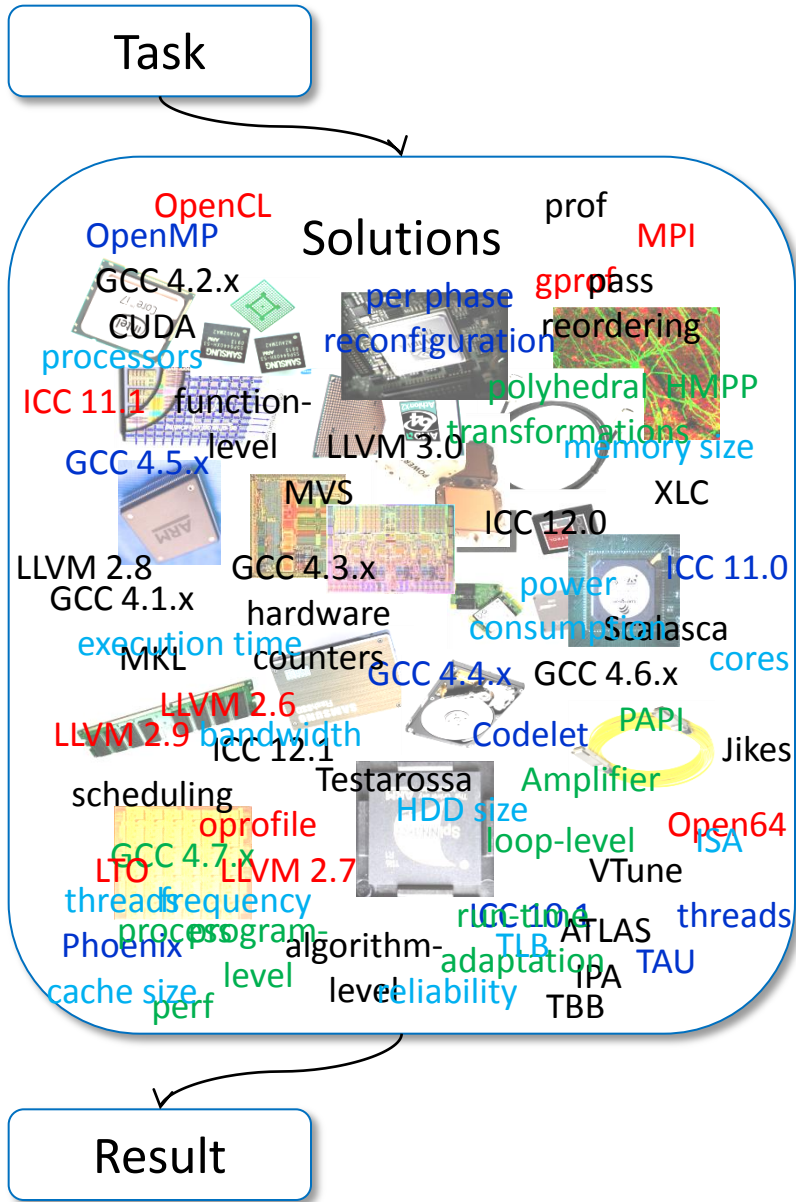

Result:

- finding the right solution for end-user is extremely challenging
- everyone is lost in choices
- dramatic increase in development time
- low ROI
- underperforming systems
- waste of energy
- ad-hoc, repetitive and error-prone manual tuning
- **slowing innovation in science and technology**

Understanding and modeling of the overall relationship between end-user algorithms, applications, compiler optimizations, hardware designs, data sets and run-time behavior became simply infeasible!

Attempts to solve these problems: auto-tuning

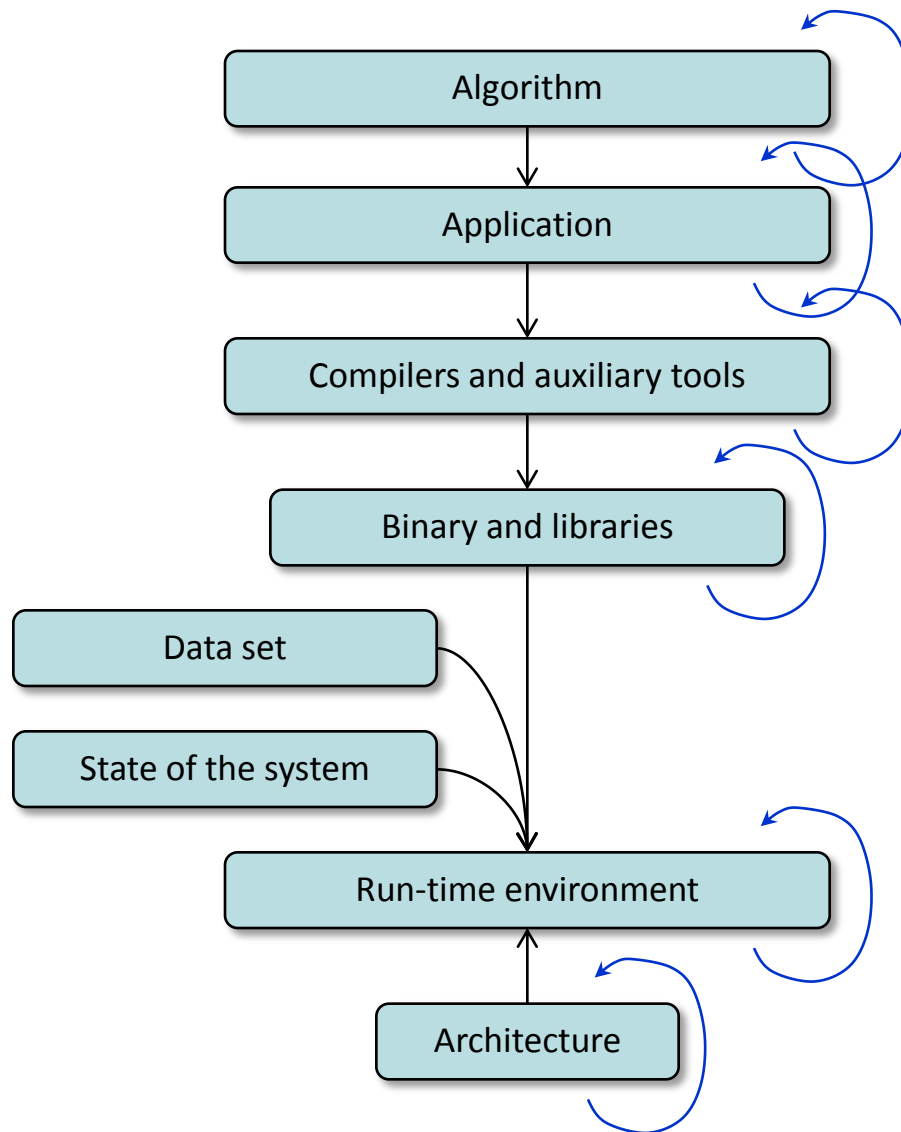

Use auto-tuning:

Explore multiple choices empirically: learn behavior of computer systems across executions

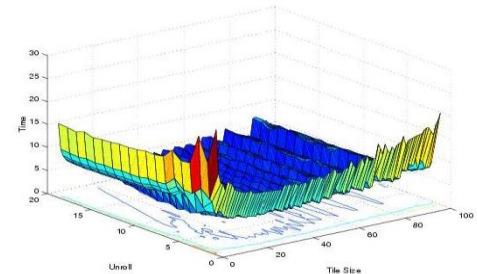

Covered all components in the last 2 decades and showed high potential but ...

Attempts to solve these problems: auto-tuning

Auto-tuning shows high potential for nearly 2 decades but still far from the mainstream in production environments.

Why?

- Optimization spaces are large and non-linear with many local minima
- Exploration is slow and ad-hoc (random, genetic, some heuristics)
- Only a few benchmarks are considered
- Often the same (one) dataset is used
- Only part of the system is taken into account (rarely reflect behavior of the whole system)
- No knowledge sharing

Attempts to solve these problems: machine learning

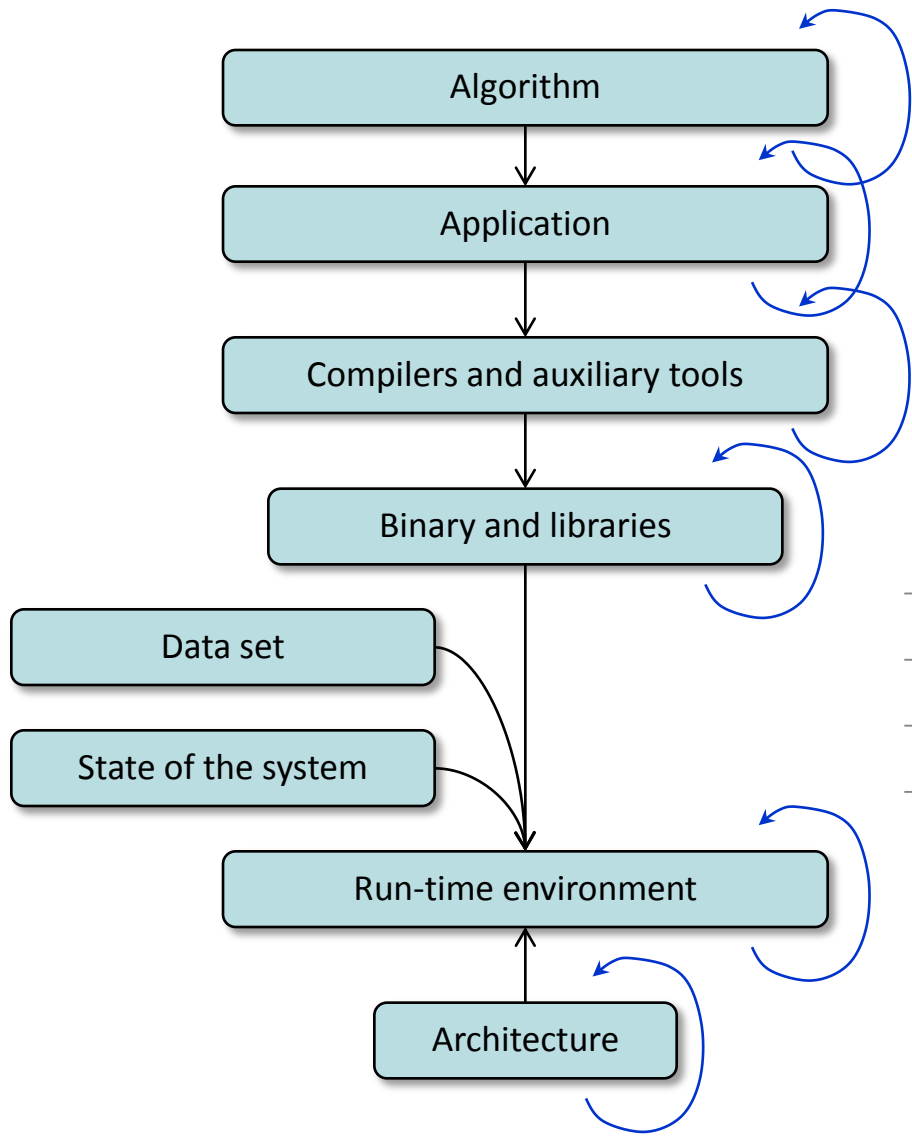

Use machine learning to speed up exploration

Apply predictive modeling to suggest profitable solutions based on properties of a task and a system

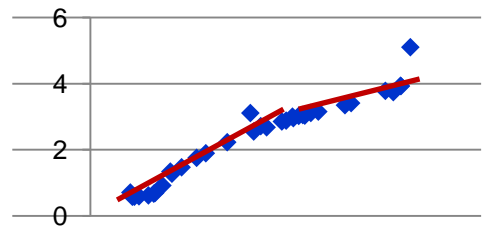

Covered all components in the last decade and showed high potential but ...

Attempts to solve these problems: machine learning

Machine learning (classification, predictive modeling) shows high potential during past decade but still far from the mainstream.

Why?

- Selection of machine learning models and right properties is non-trivial: ad-hoc in most of the cases
- Limited training sets
- Only part of the system is taken into account (rarely reflect behavior of the whole system)
- No knowledge sharing

Attempts to solve these problems: co-design

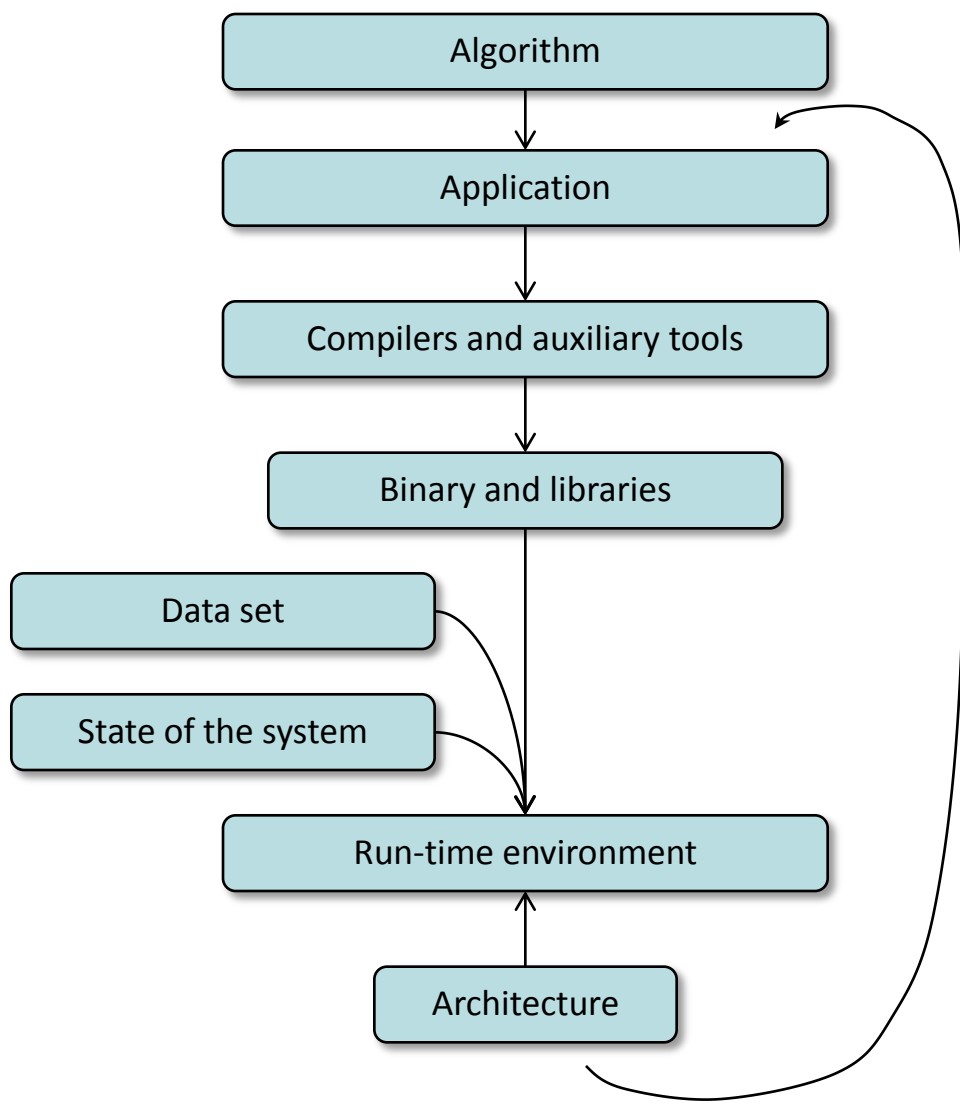

Co-design:
Explore choices and behavior of the whole system.

Showed high potential in the last years but ...

Attempts to solve these problems: co-design

**Co-design is currently a buzz word and a hot research topic
but still far from the mainstream.**

Why?

- Even more choices to explore and analyze
- Often impossible to expose tuning choices or obtain characteristics at all levels
- Limited training sets
- Still no knowledge sharing

Can we crowdsource auto-tuning? My main focus since 2004

Got stuck with a limited number of benchmarks, datasets, architectures and a large number of optimizations and generated data
- needed dramatically new approach!

Millions of users run realistic applications on different architectures with different datasets, run-time systems, compilers, optimizations!



Can we leverage their experience and computational resources?

**Can we transparently distribute optimization
and learning across many users?**

Challenges

How can we evaluate optimizations in a realistic environment without complex recompilation frameworks and without source code?

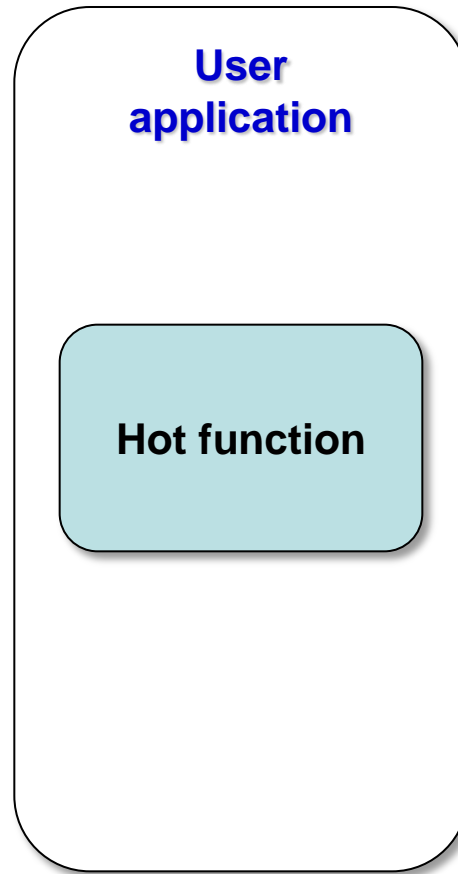

Challenges

**First problem:
need reference run with the same dataset**

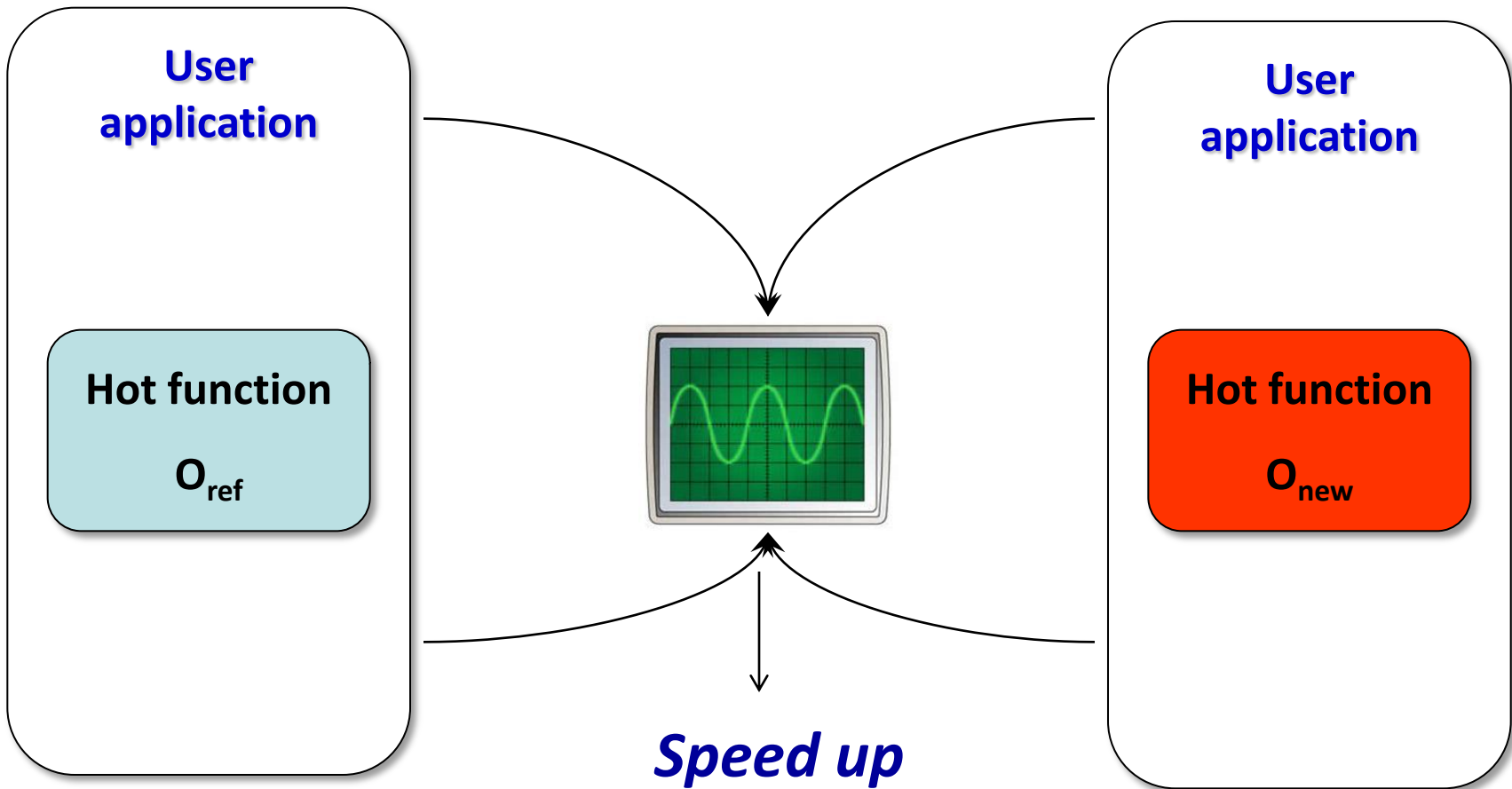

Challenges

Second problem: variation in execution time due to different run-time states

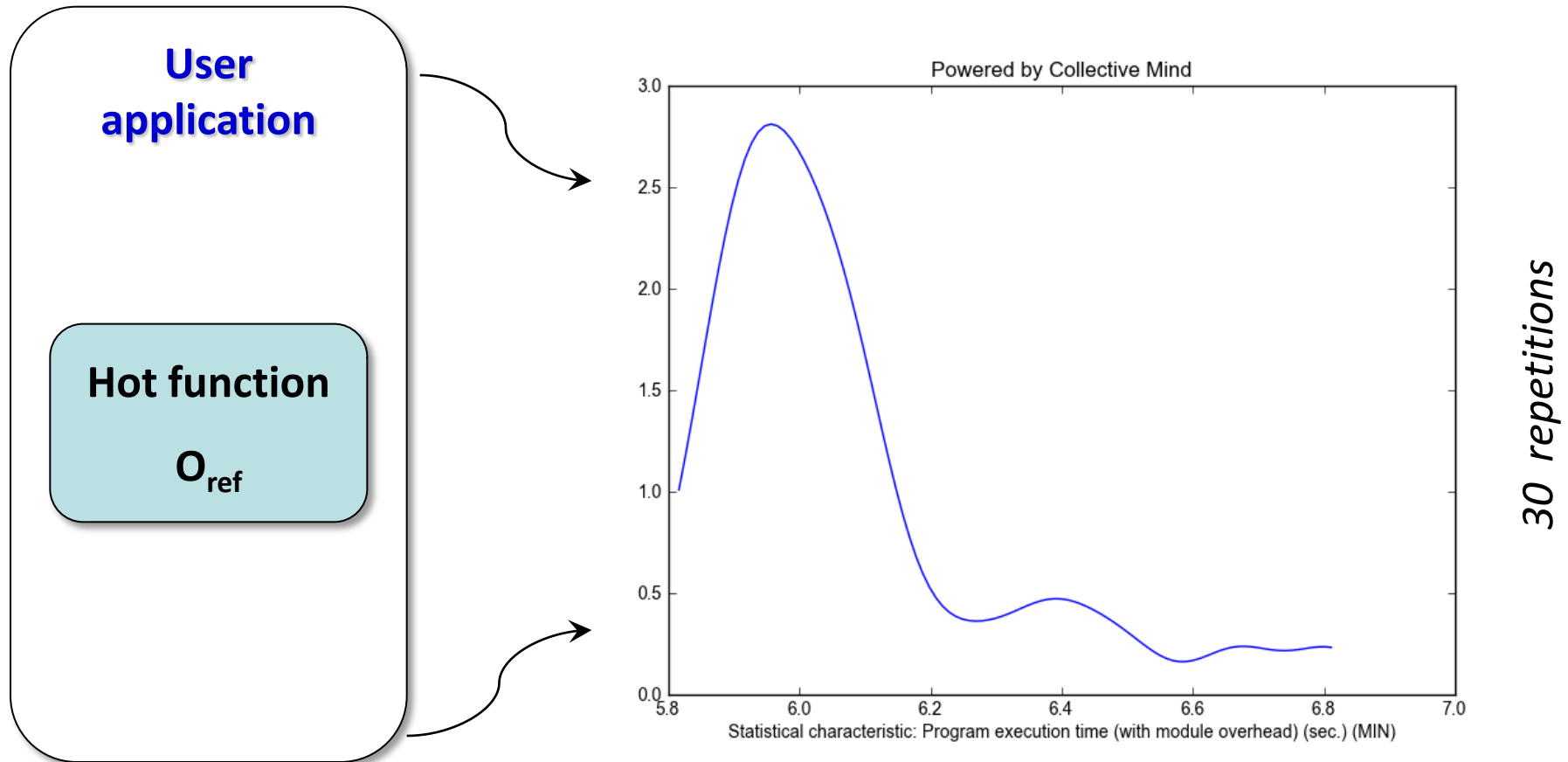

Challenges

Second problem: variation in execution time due to different run-time states

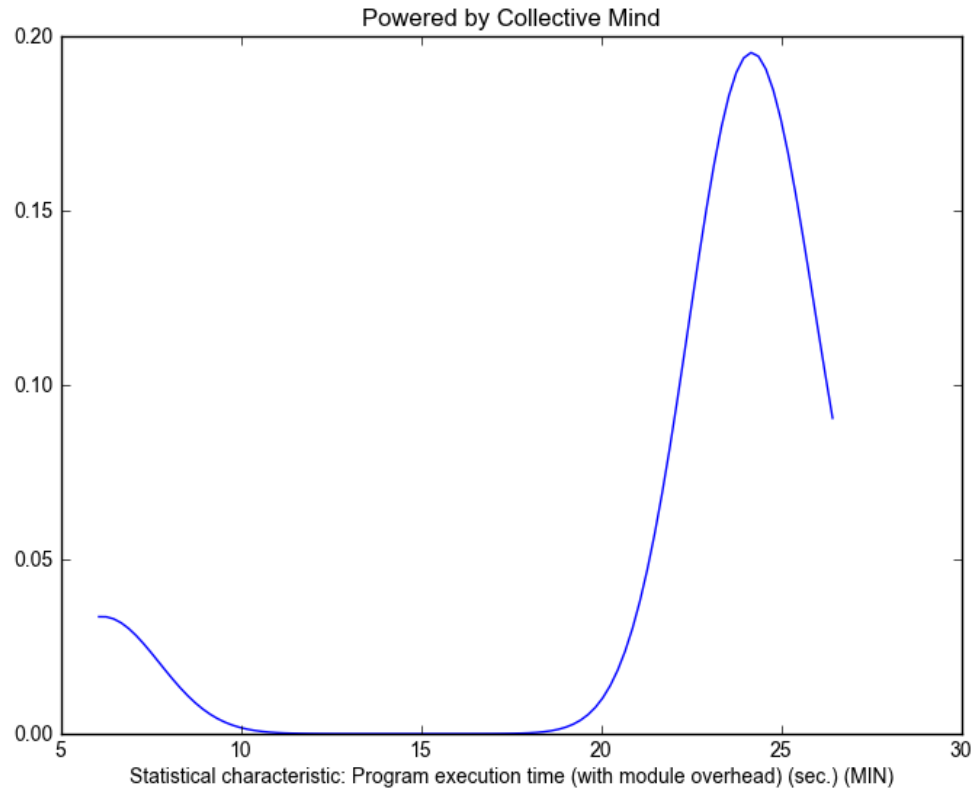
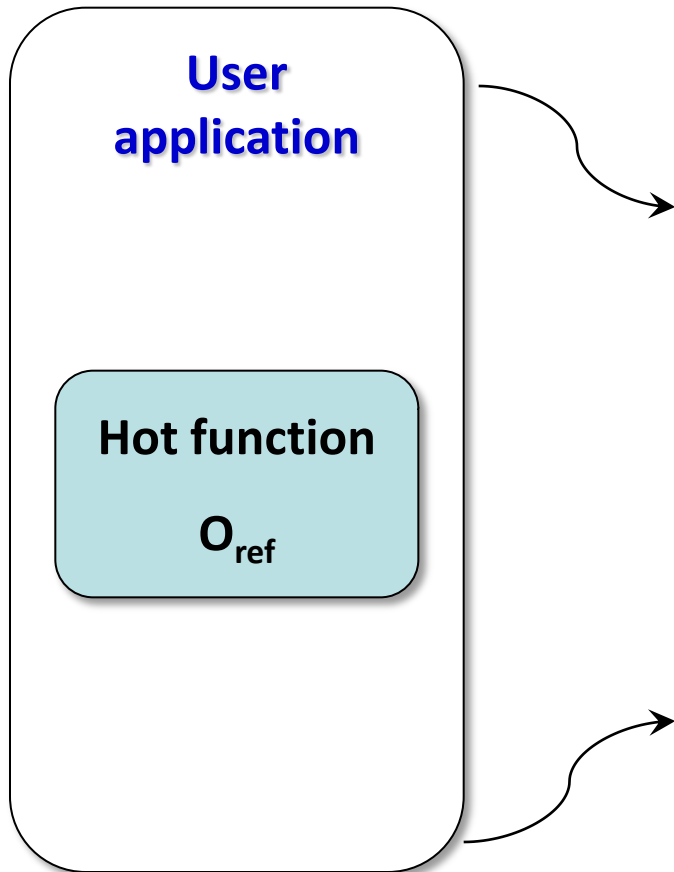

30 repetitions

Challenges

How can we evaluate some optimization in a realistic environment?

Second problem: variation in execution time due to different run-time states (parallel processes, adaptive scheduling, pinning, cache state, bus state, frequency changes, etc)

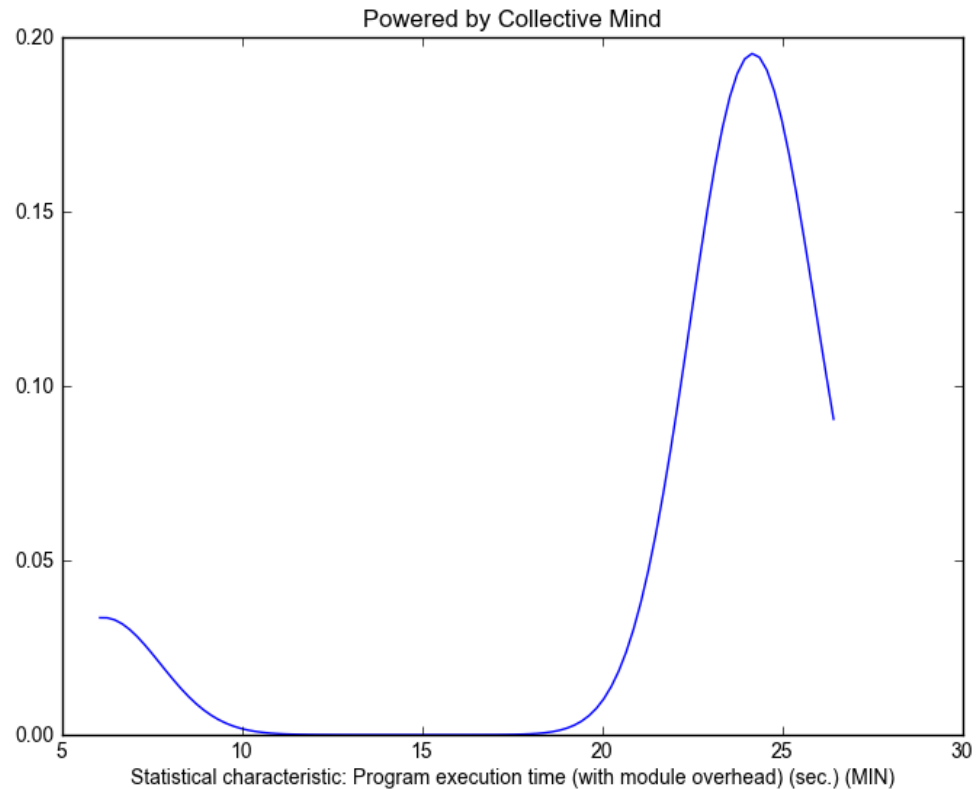
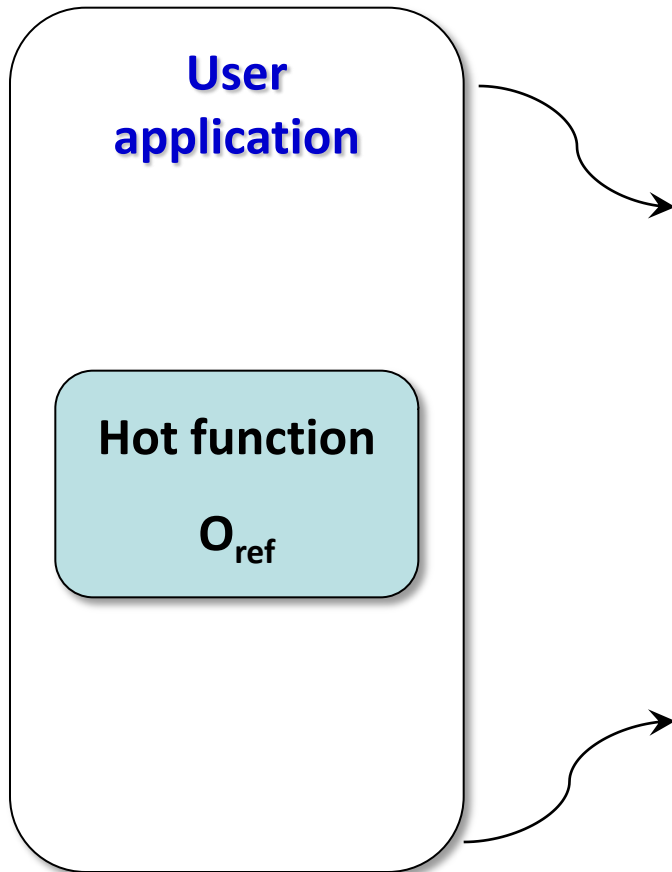

Our approach: static multiversioning

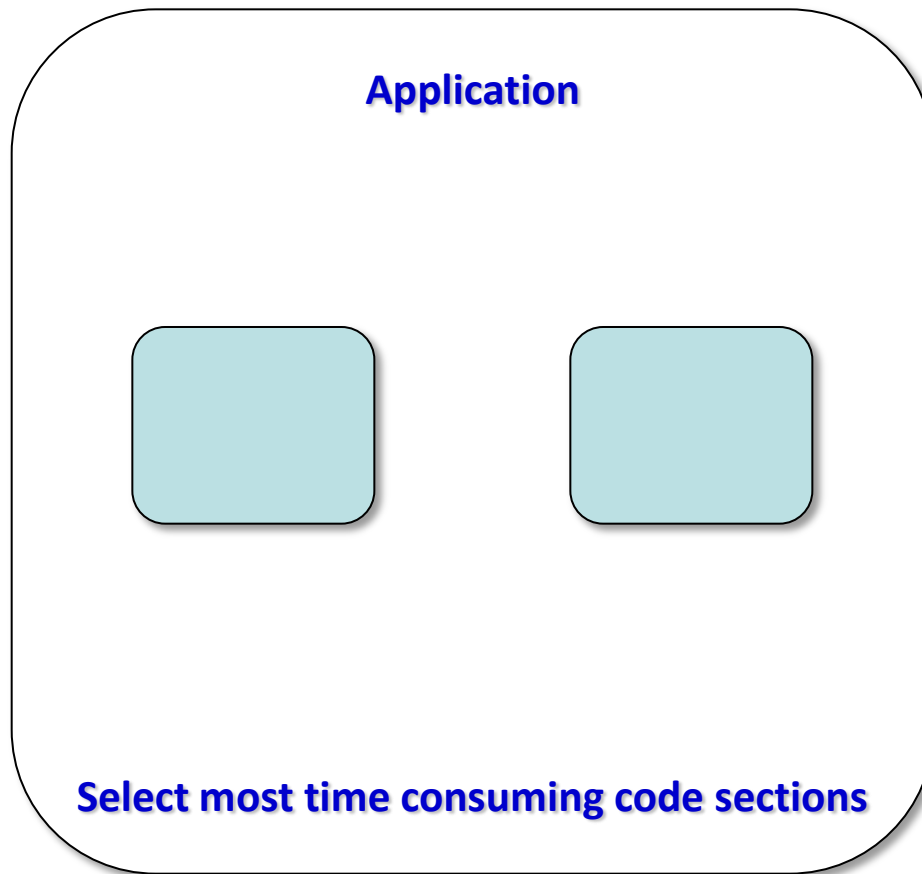

Our approach: static multiversioning

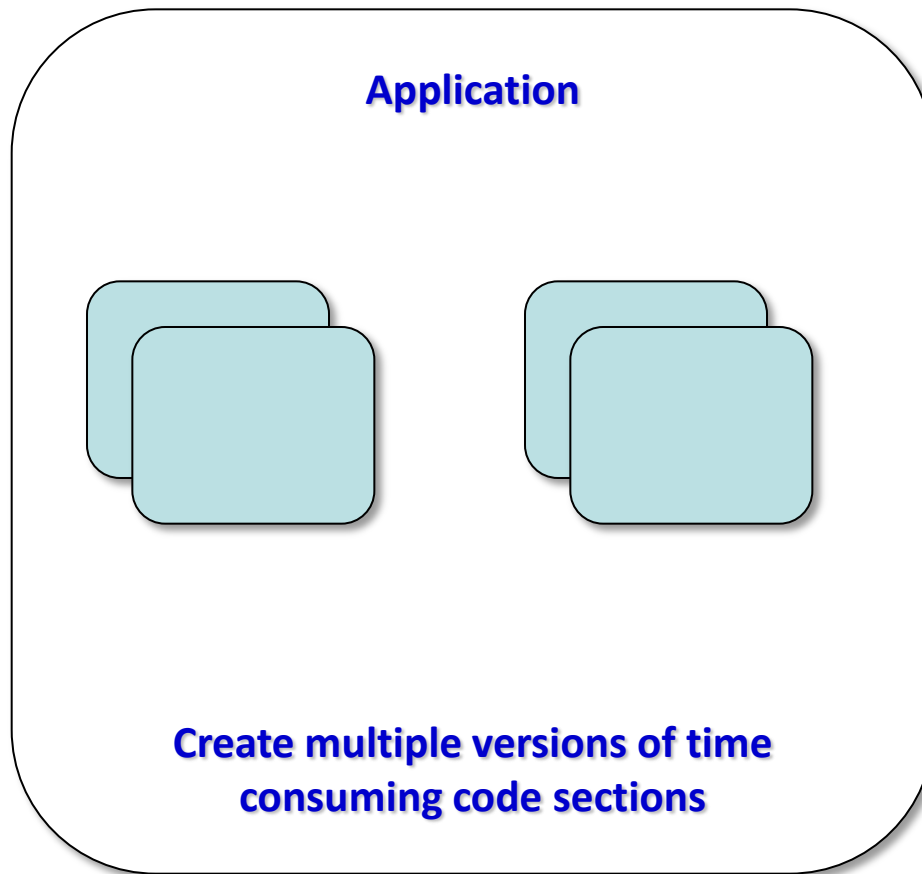

Our approach: static multiversioning

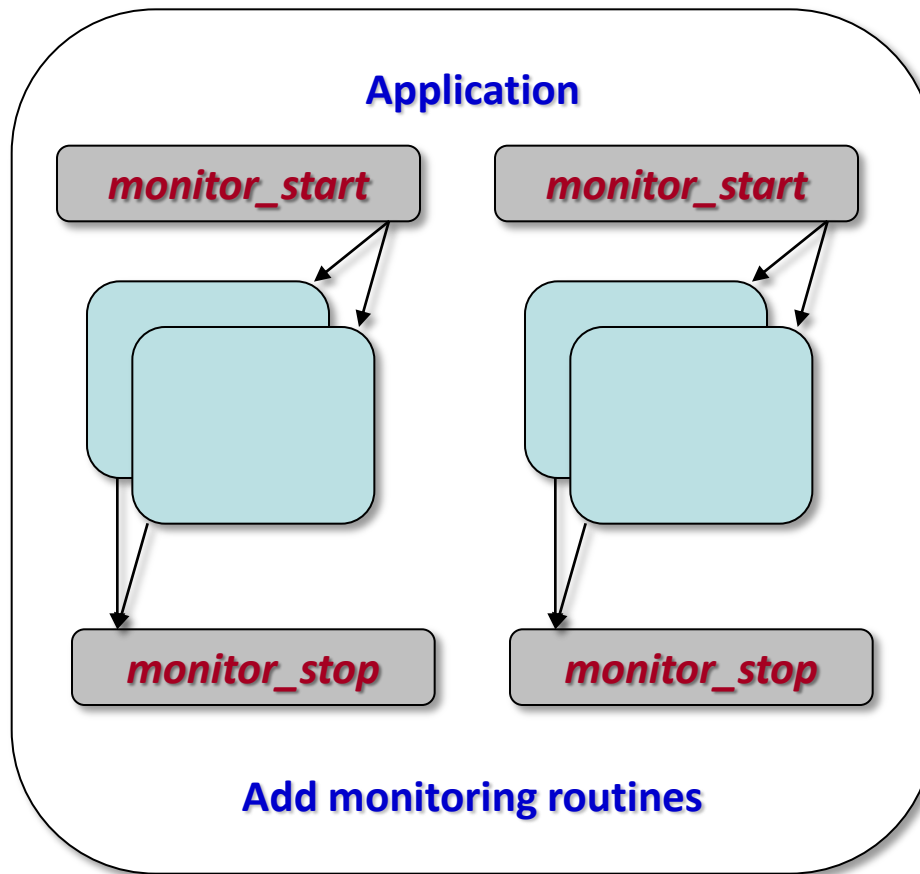

Our approach: static multiversioning

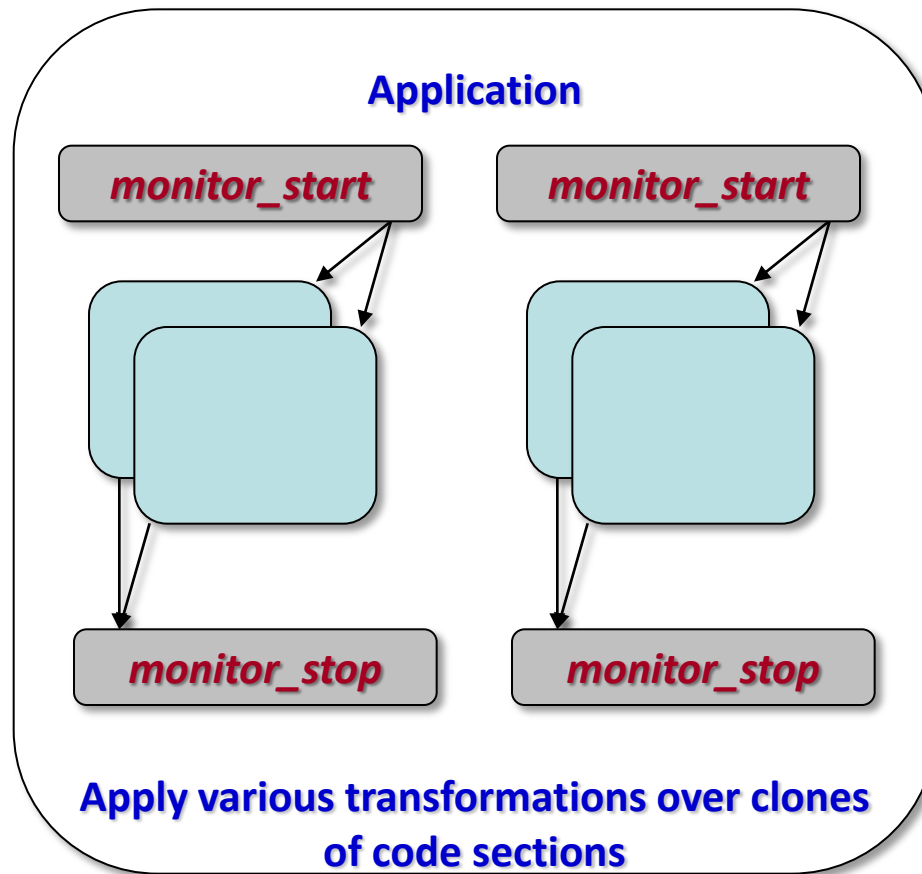

Our approach: static multiversioning

Select global or fine-grain internal compiler (or algorithm) optimizations

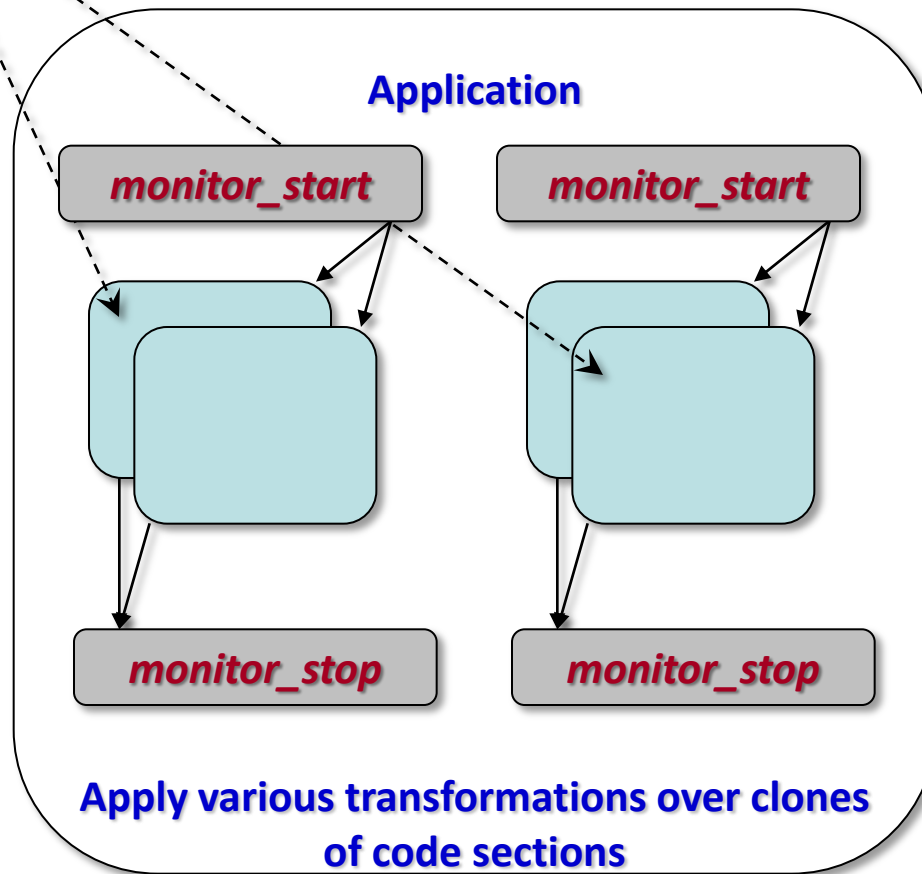

Our approach: static multiversioning

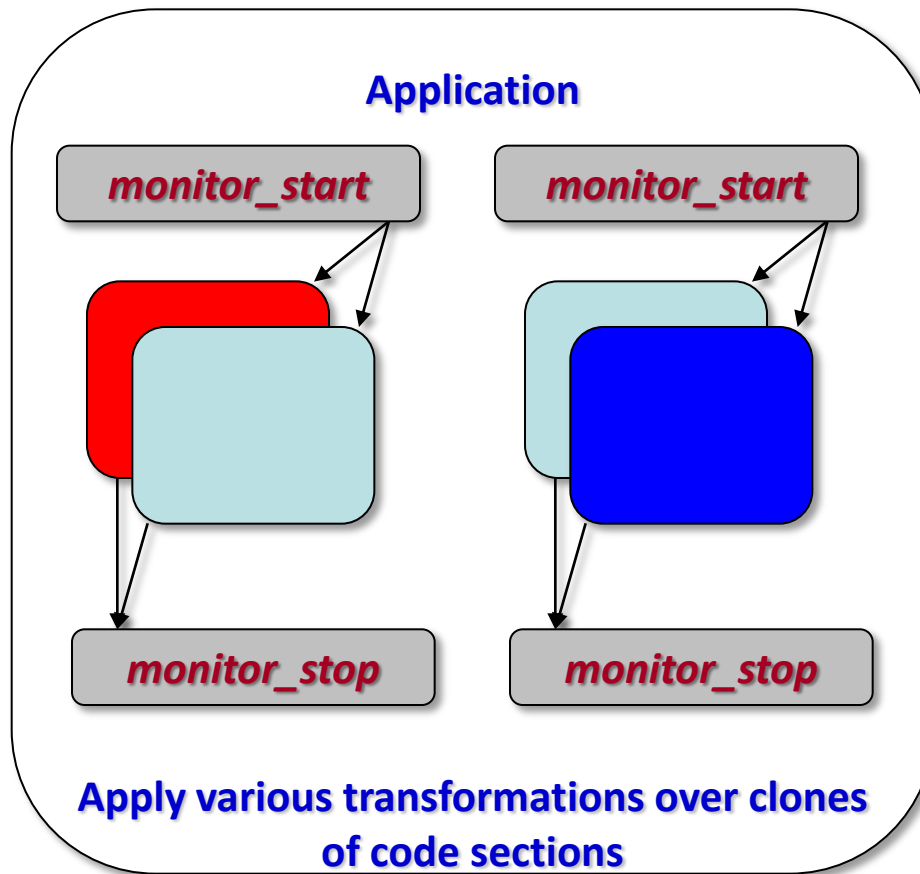

Our approach: static multiversioning

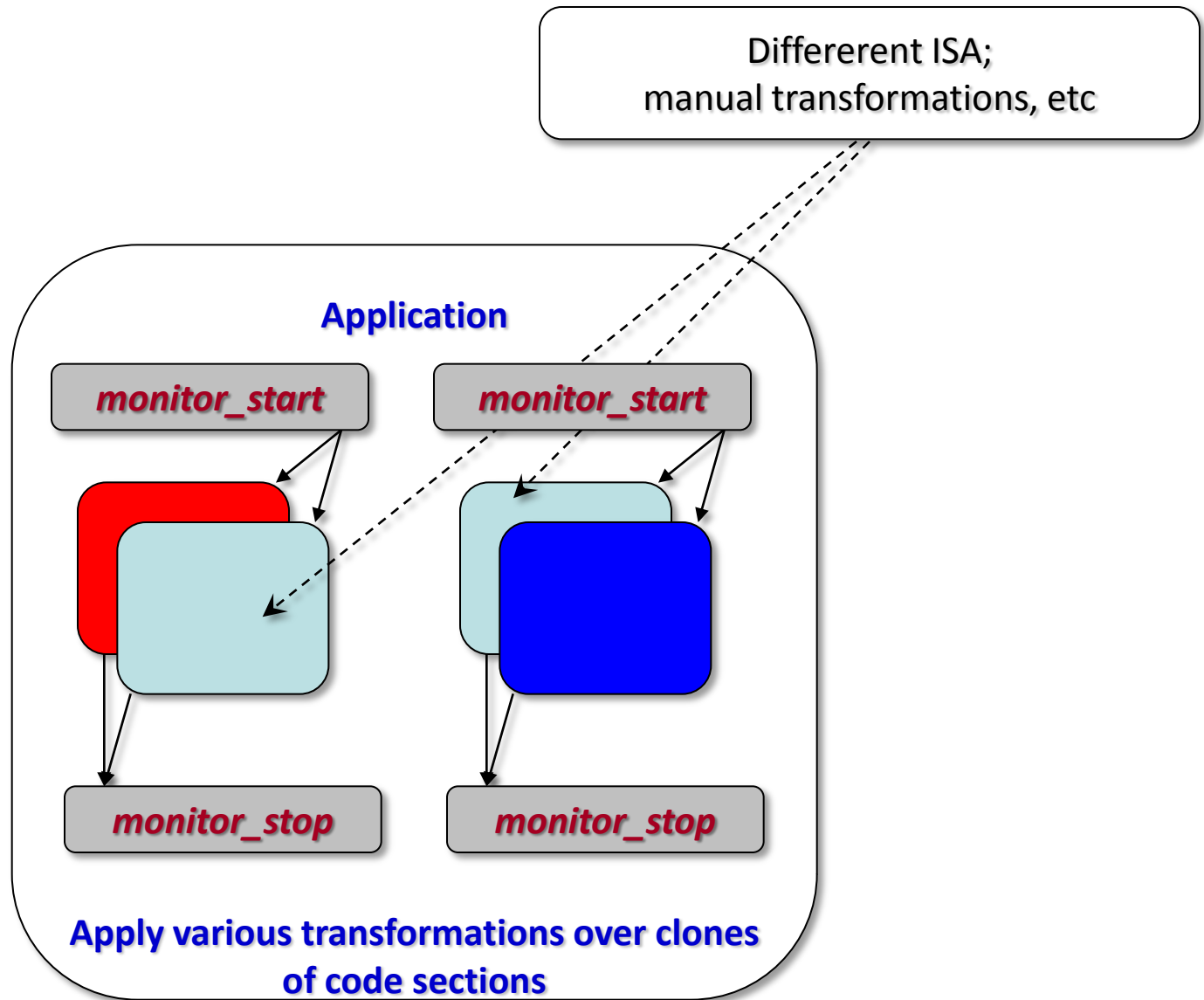

Our approach: static multiversioning

Final instrumented program

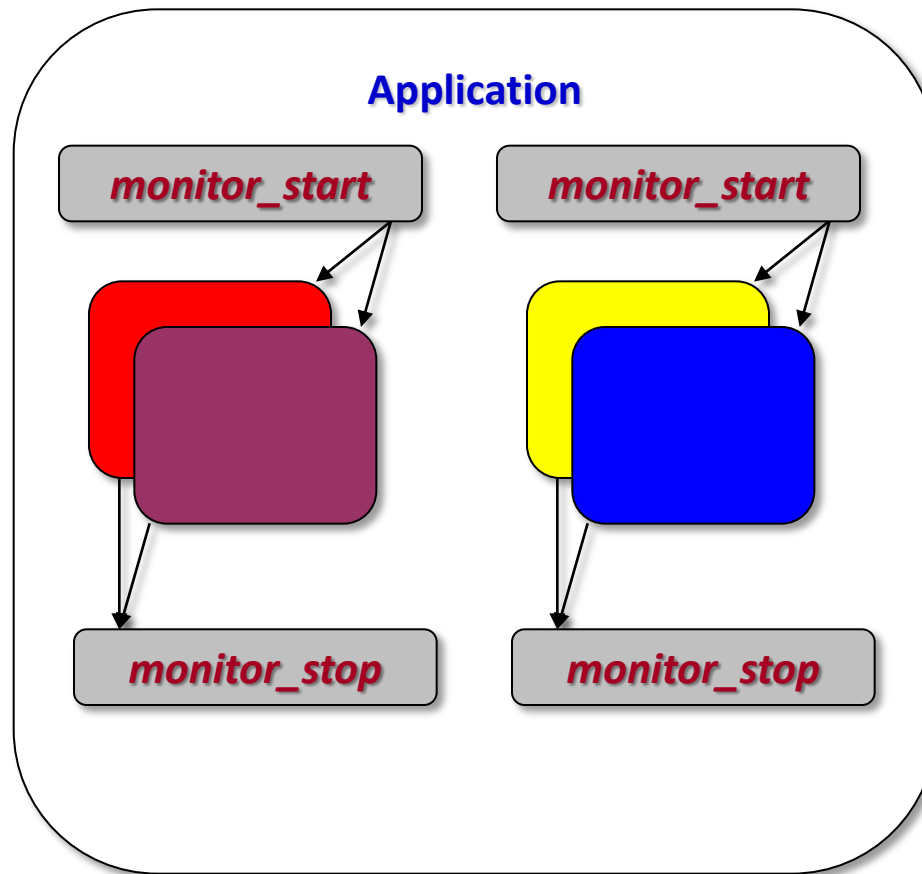

Observations: program execution phases

IPC for subroutine resid of benchmark mgrid across calls

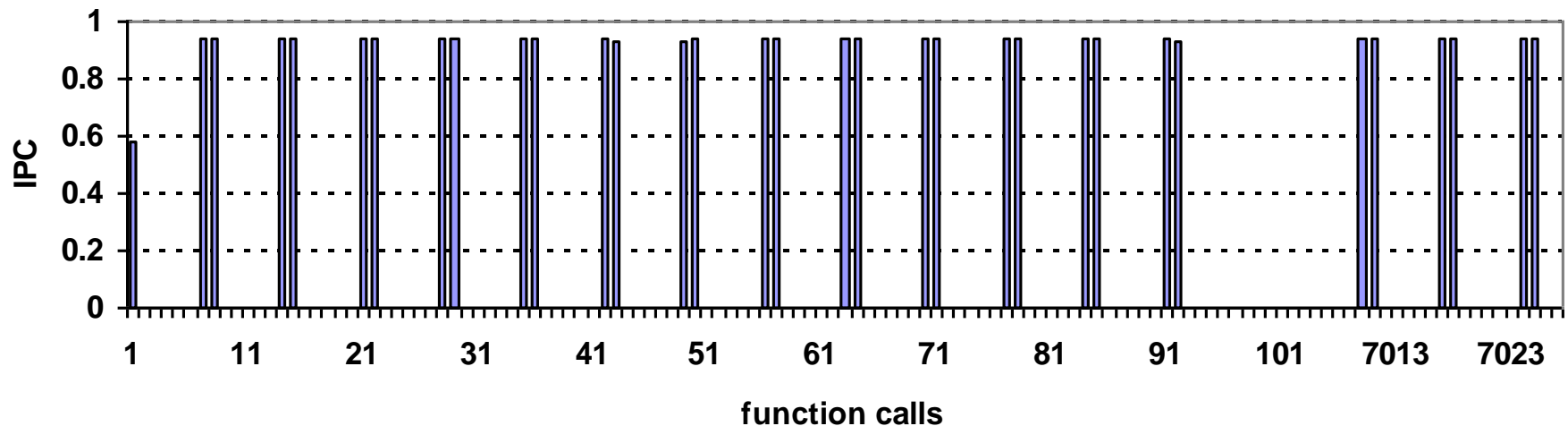

- *Define stability by 3 consecutive or periodic executions with the same IPC*
- *Predict further occurrences with the same IPC (using period and length of regions with stable performance)*

Observations: program execution phases

IPC for subroutine resid of benchmark mgrid across calls

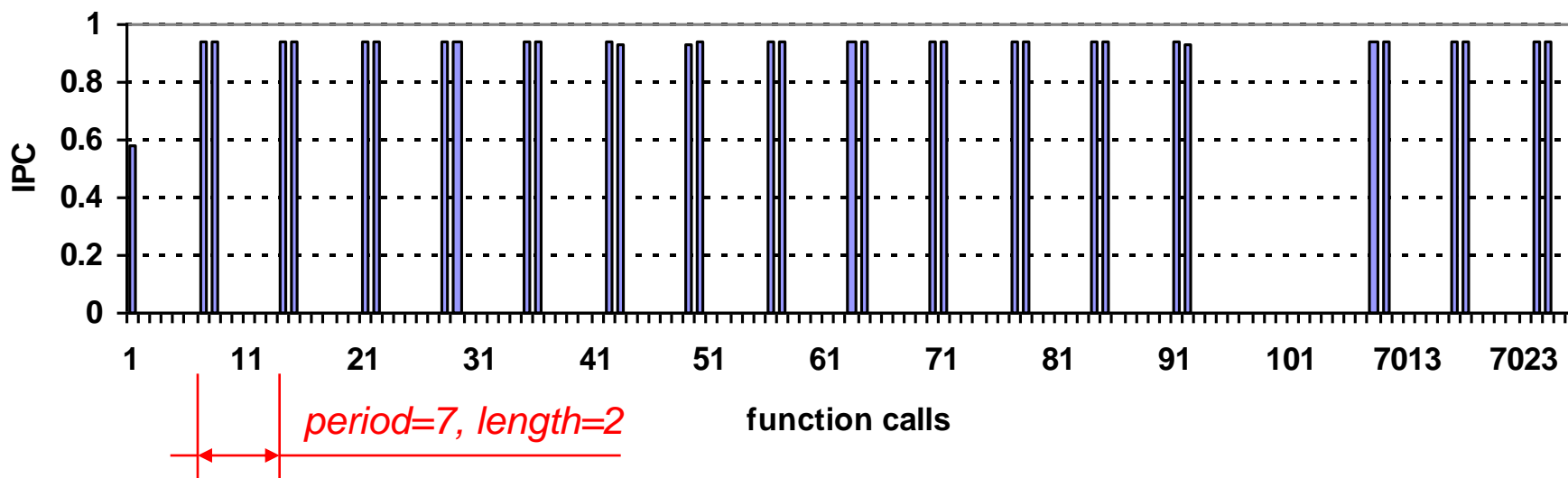

- *Define stability by 3 consecutive or periodic executions with the same IPC*
- *Predict further occurrences with the same IPC (using period and length of regions with stable performance)*

Observations: program execution phases

Some programs exhibit stable behavior

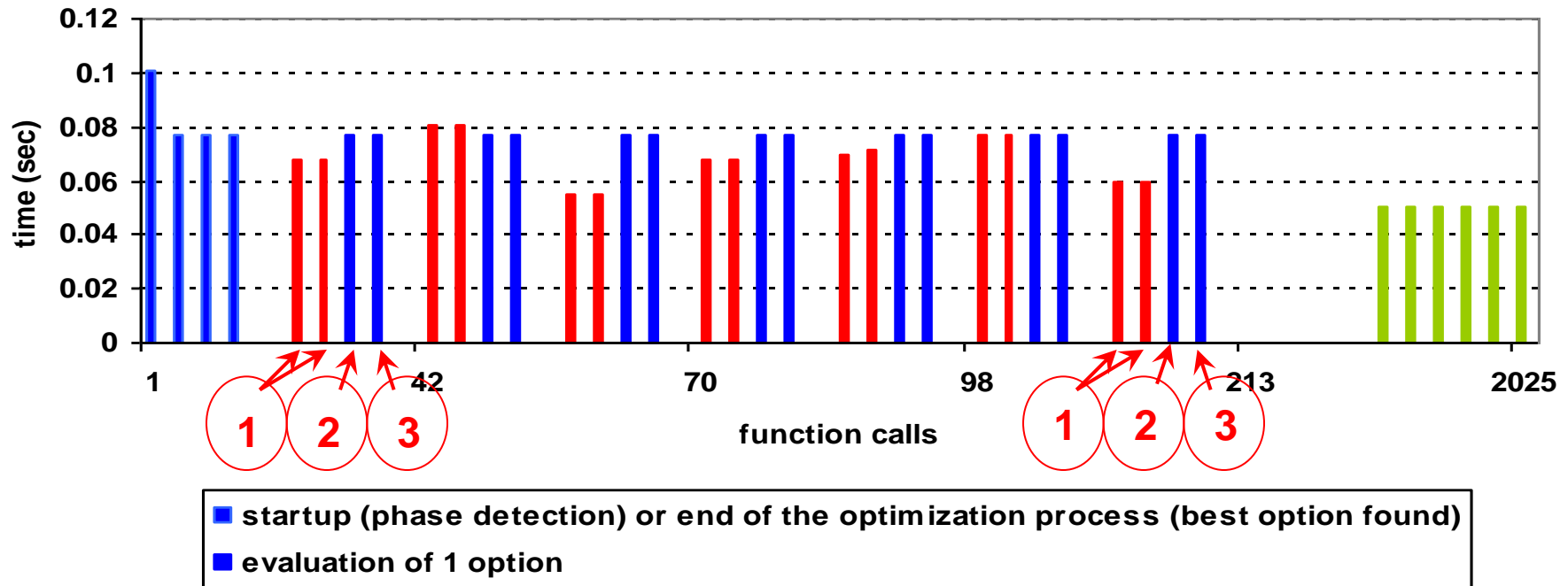

- 1) Consider clone with new optimization is evaluated after 2 consecutive executions of the code section with the same performance
- 2) Ignore one next execution to avoid transitional effects
- 3) Check baseline performance (to verify stability prediction)

Observations: program execution phases

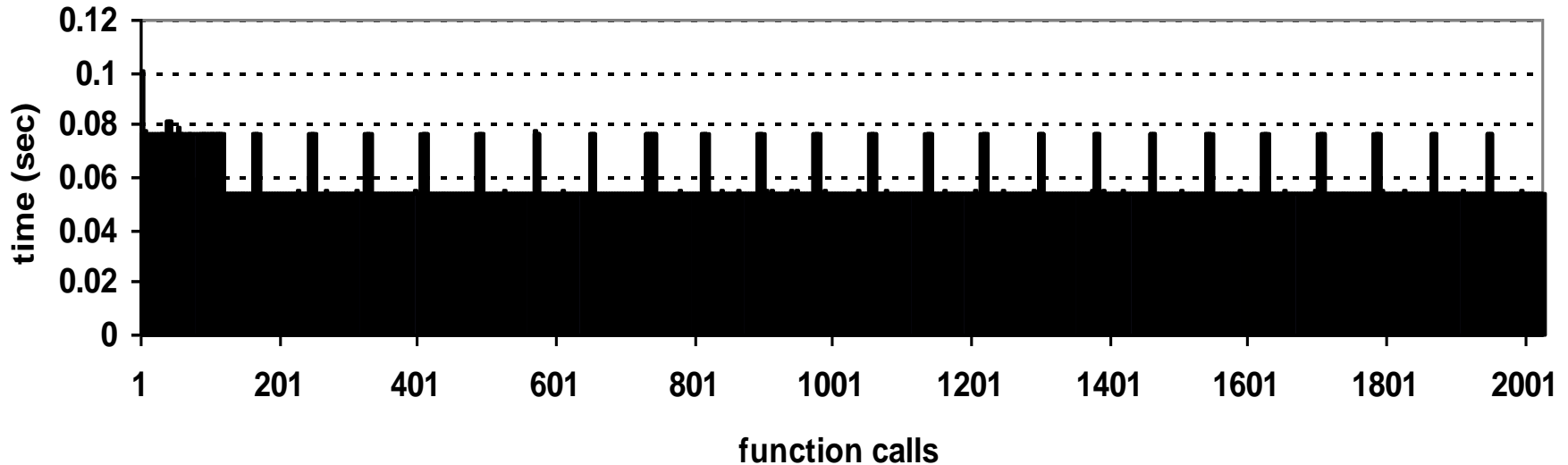

- Can transparently to end-user evaluate multiple optimizations
- Statically enable adaptive binaries (that can react to dataset or run-time state changes without any need for JIT or other complex frameworks)

Transparent monitoring and adaptation of static programs

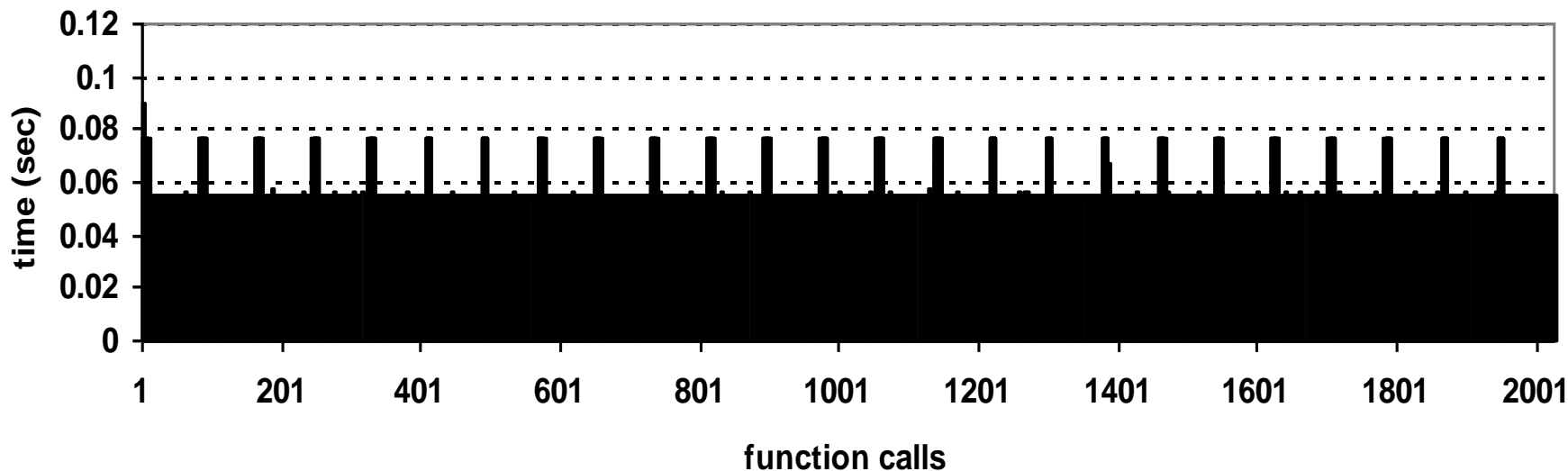

- Can transparently to end-user evaluate multiple optimizations
- Statically enable adaptive binaries (that can react to dataset or run-time state changes without any need for JIT or other complex frameworks)

• Grigori Fursin et al. *A Practical Method For Quickly Evaluating Program Optimizations*. *Proceedings of the 1st International Conference on High Performance Embedded Architectures & Compilers (HiPEAC 2005)*, number 3793 in LNCS, pages 29-46, Barcelona, Spain, November 2005 **Highest ranked paper**

Observations: random behavior

Randomly select versions at run-time
Monitor speedup variation over time

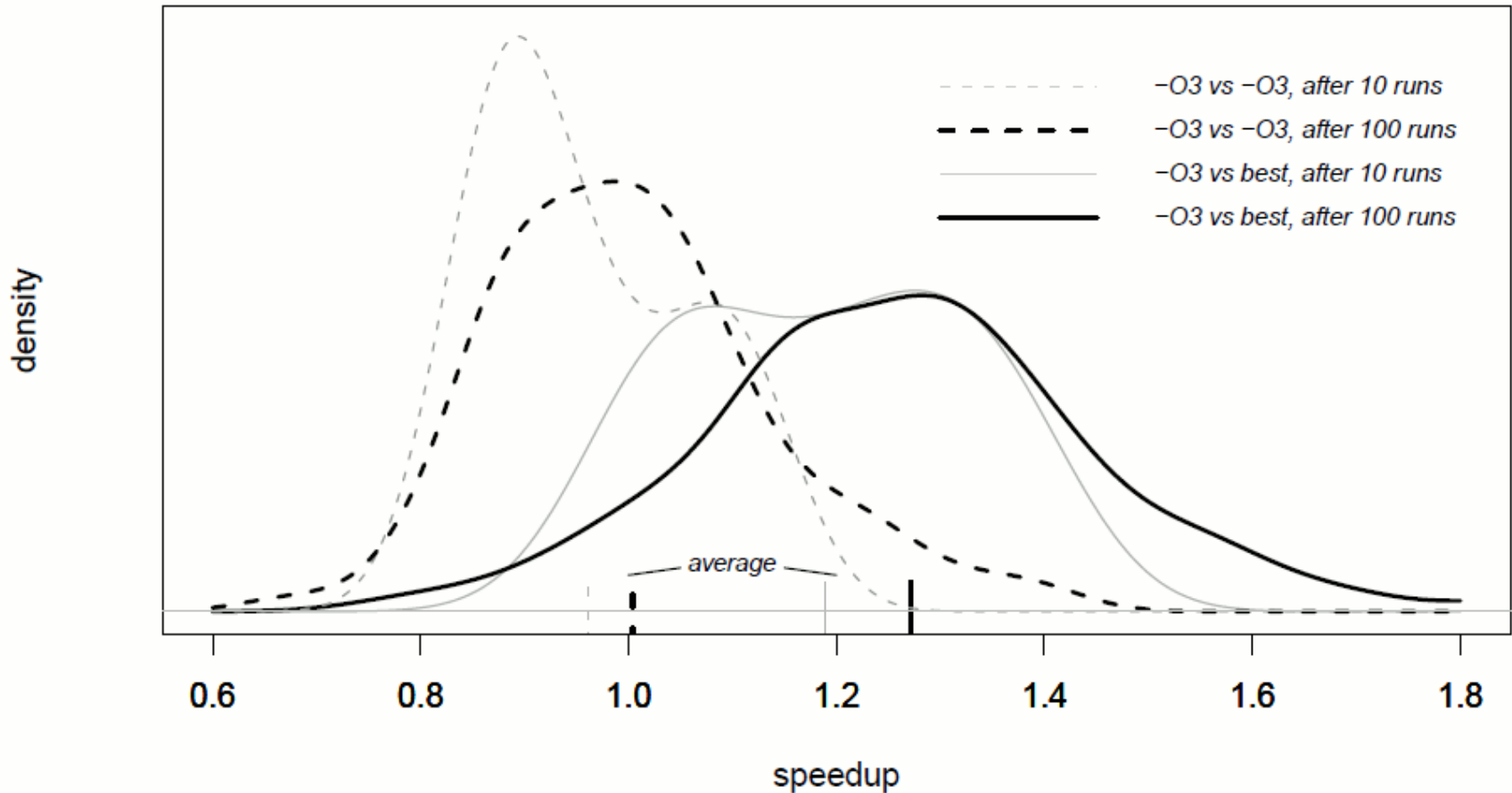

jpeg decoder, GCC 4.5, Intel architecture

Transparently measuring the impact of optimizations

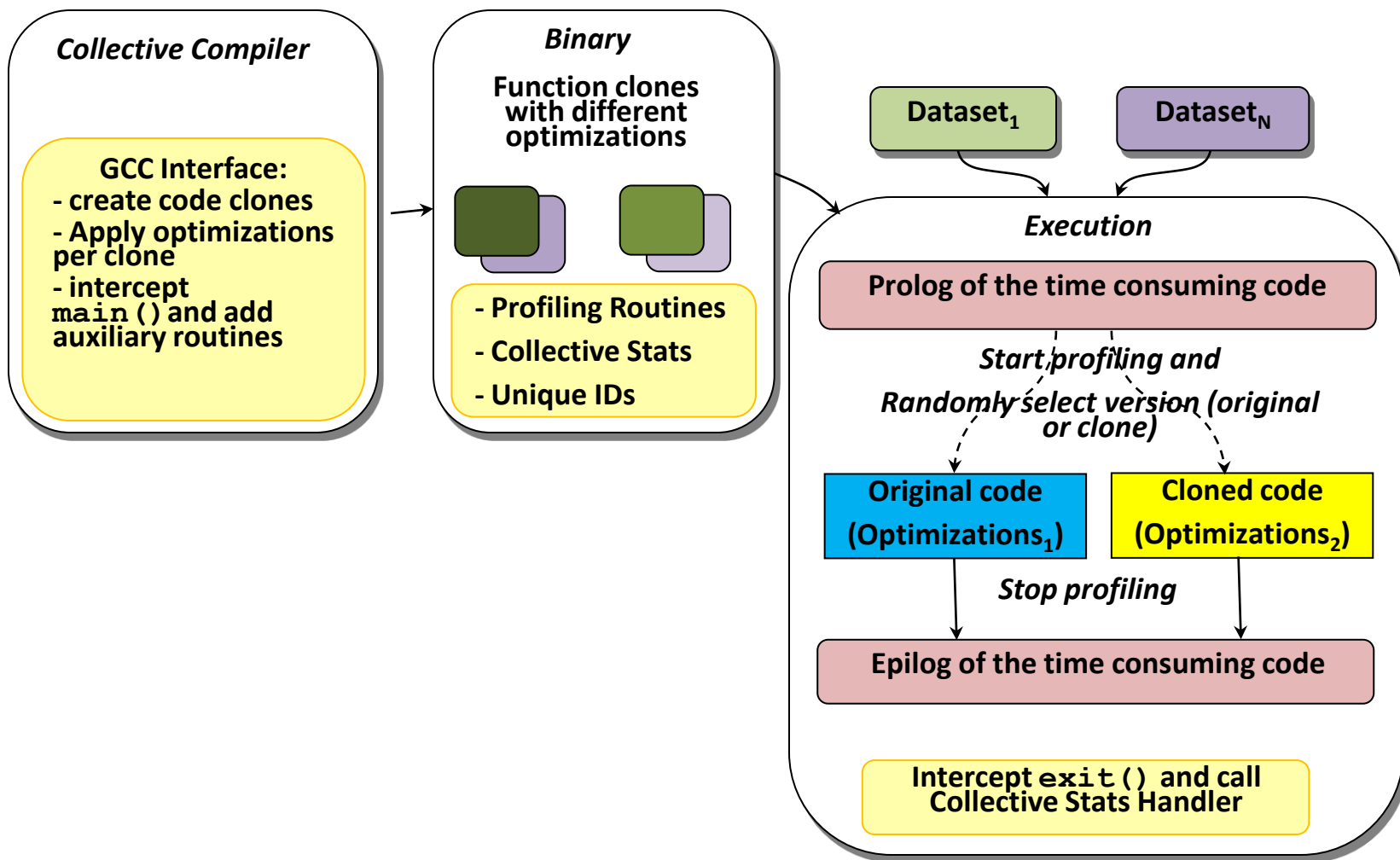

Transparently measuring the impact of optimizations

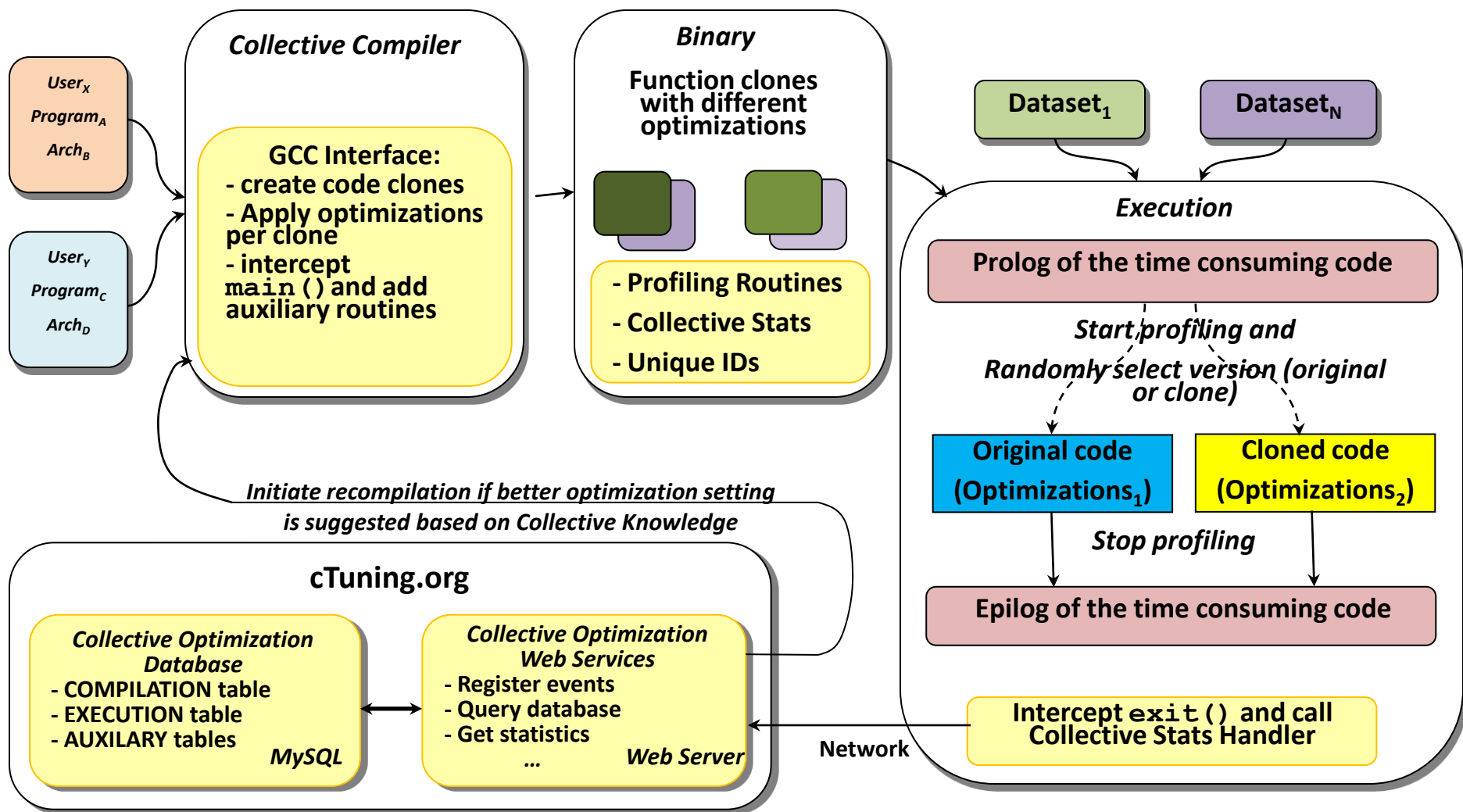

Speeding up research (2005-cur.)

- **Can observe behavior and evaluate optimizations in various GRID servers, cloud services, desktops, etc ...**
 - multiple benchmarks/datasets
 - multiple architectures
 - multiple compilers
 - multiple optimizations

**Opened up many interesting research opportunities,
particularly for data mining and predictive modeling!**

• Grigori Fursin et al. **Collective Optimization: A Practical Collaborative Approach**. *ACM Transactions on Architecture and Code Optimization (TACO)*, December 2010, Volume 7, Number 4, pages 20-49

Concept is included into EU HiPEAC research vision 2012-2020

• Grigori Fursin et al. **Collective optimization**. *Proceedings of the International Conference on High Performance Embedded Architectures & Compilers (HiPEAC 2009)*, Paphos, Cyprus, January 2009

Collaborative exploration of large optimization spaces

Multi-objective optimizations (depend on user scenarios):

HPC and desktops: *improving execution time*

Data centers and real-time systems: *improving execution and compilation time*

Embedded systems: *improving execution time and code size*

Now additional requirement: *reduce power consumption*

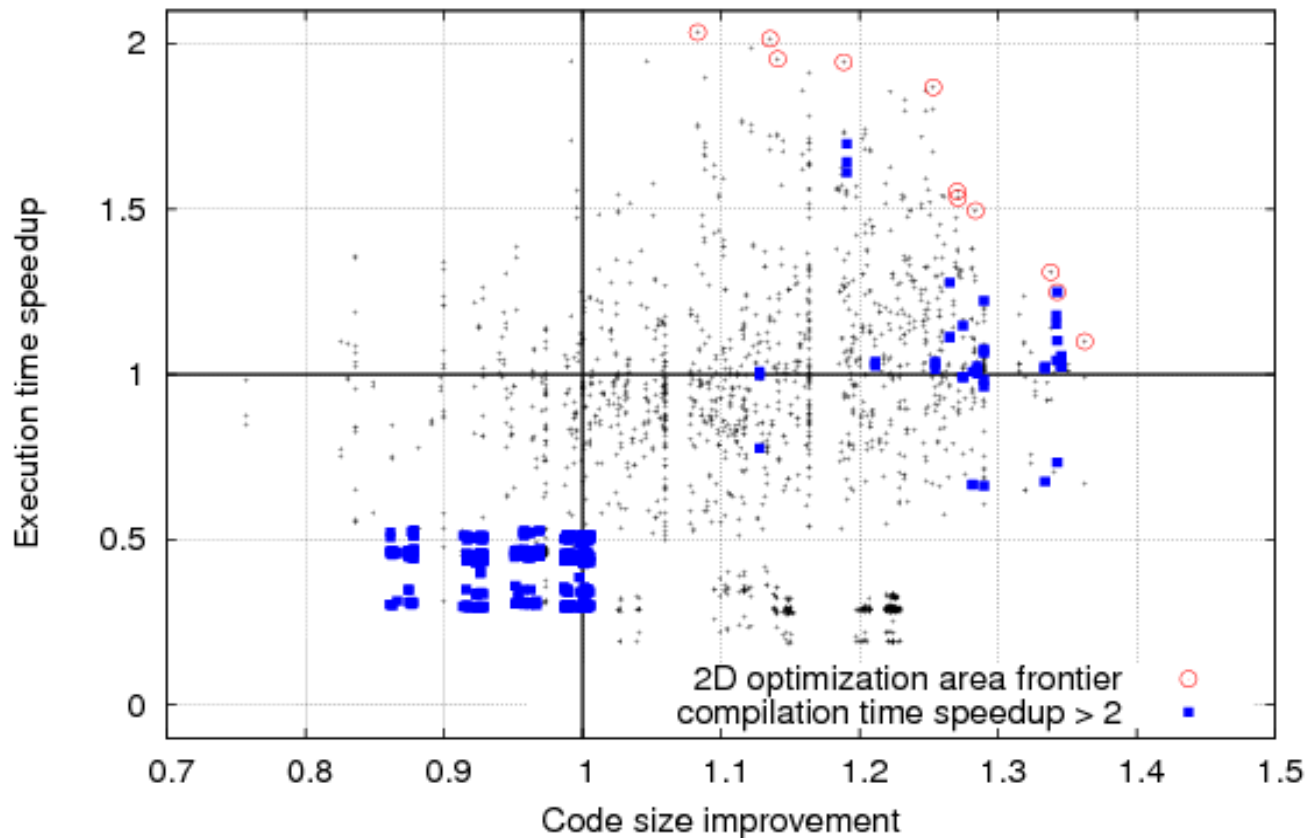

susan corners kernel

Intel Core2

GCC 4.4.4

similar results on ICC 11.1

baseline opt=-O3

~100 optimizations

random combinations
(50% probability)

Nowadays used for
auto-parallelization,
reduction of contentions,
reduction of communication
costs, etc.

Online focused exploration and learning

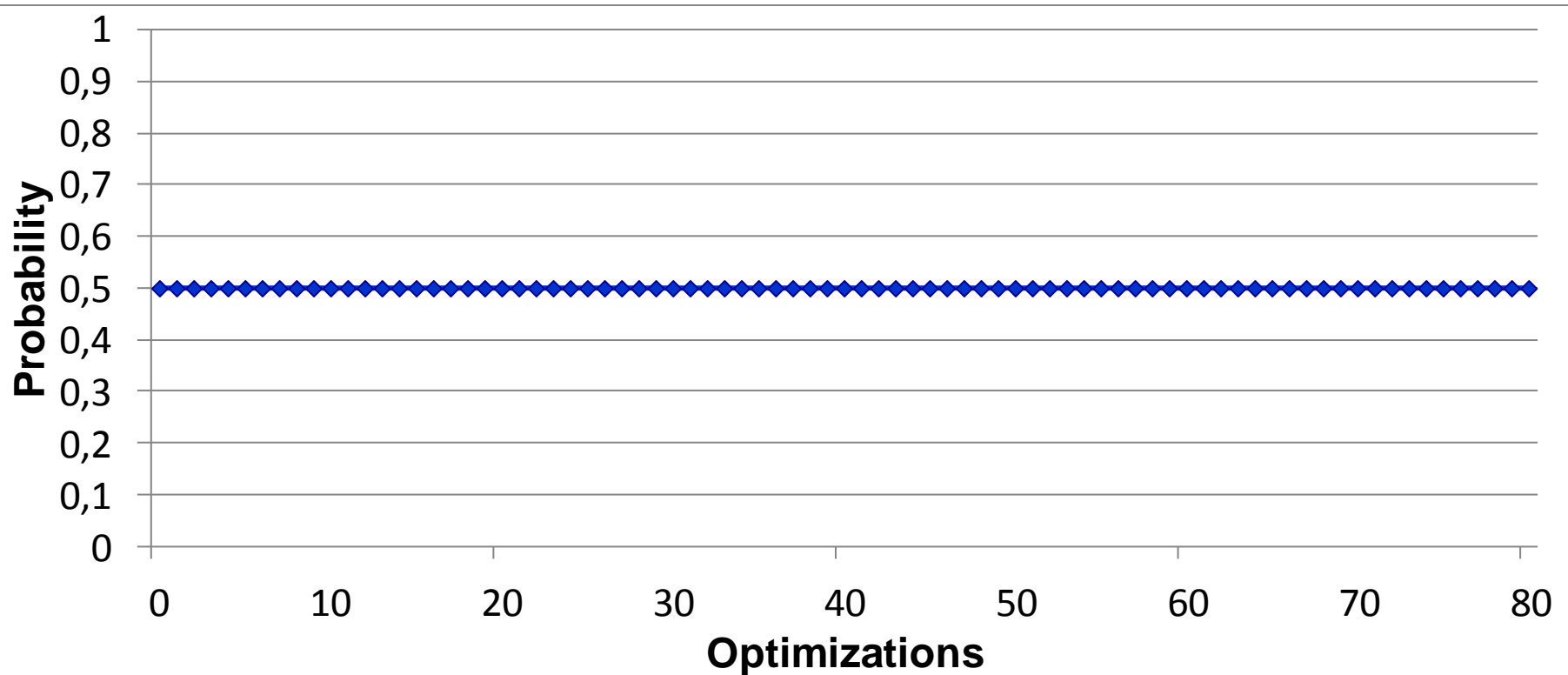

Start: 50% probability to select optimization (uniform distribution)

**Avoiding collection of huge amount of data -
filtering (compacting) and learning space on the fly**

Online focused exploration and learning

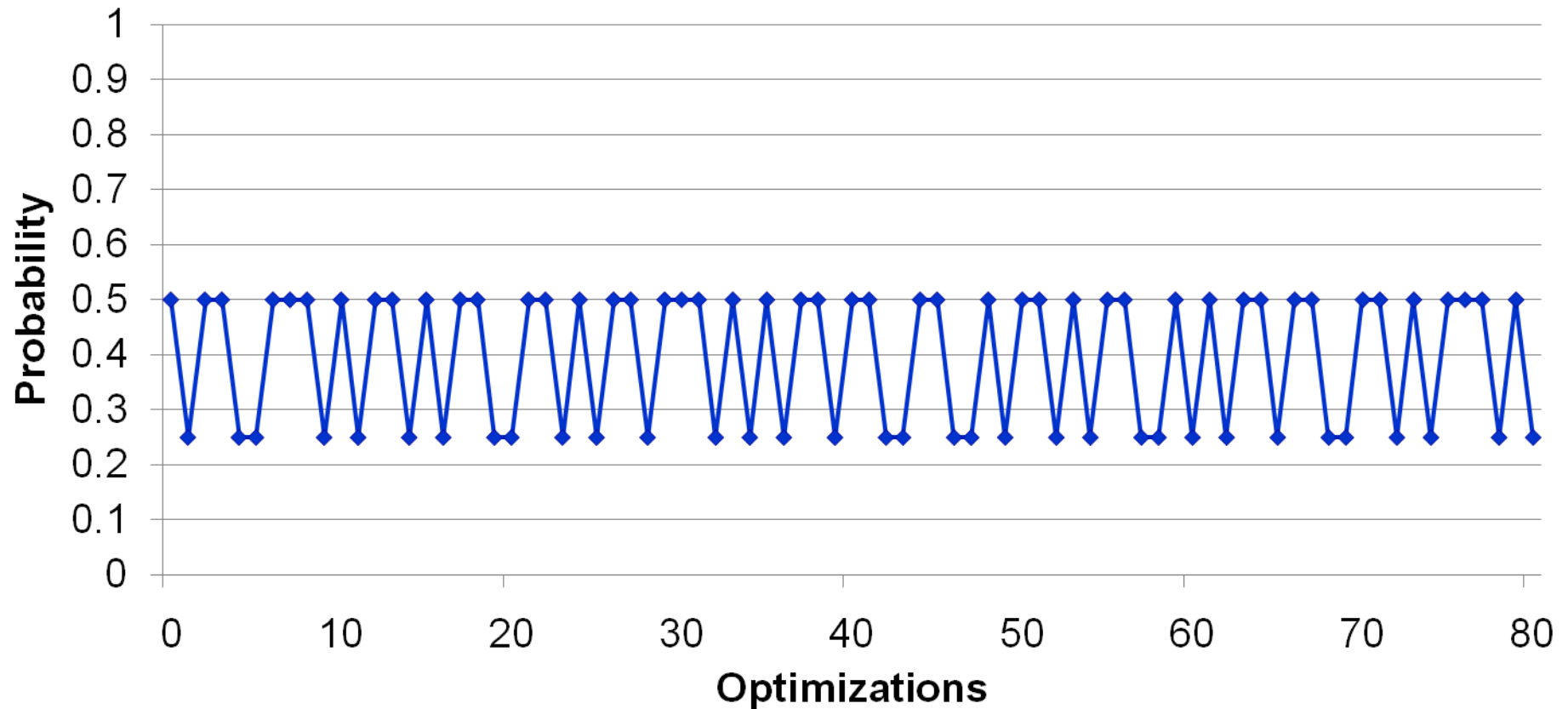

Current random selection of optimizations reduced execution time:
reduce probabilities of the selected optimizations

Online focused exploration and learning

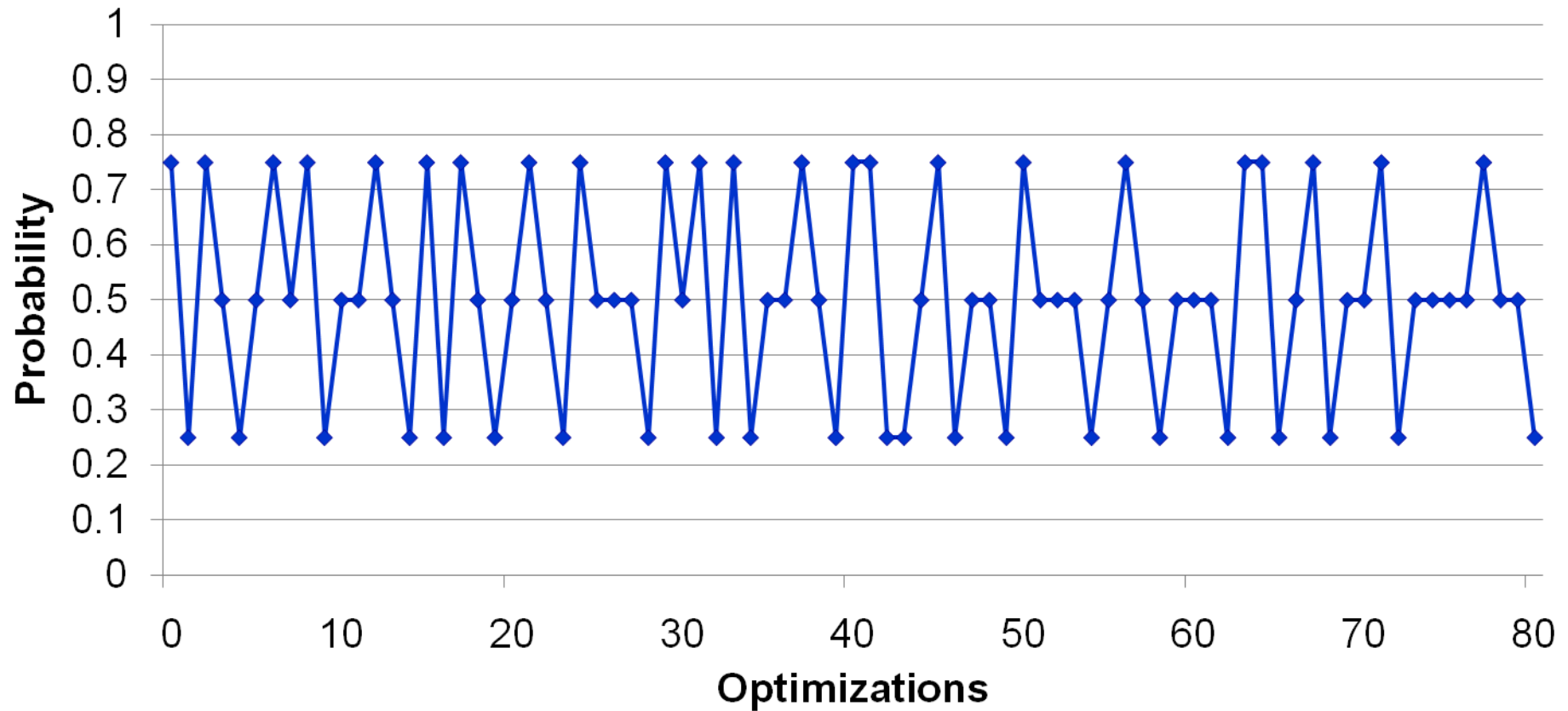

Current random selection of optimizations improved execution time:
reward probabilities of the selected optimizations

Online focused exploration and learning

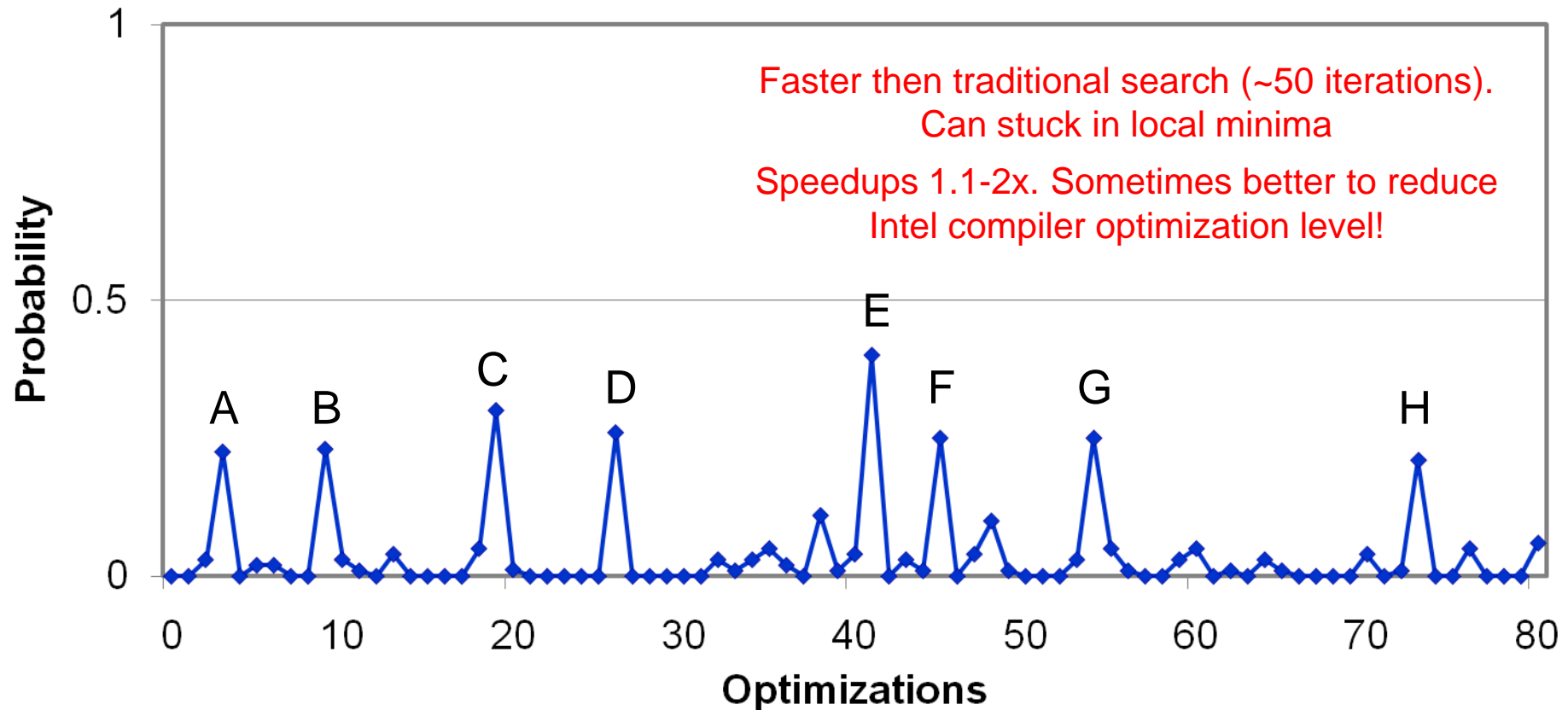

“good optimizations” across all programs:

A – Break up large expression trees
B – Value propagation
C – Hoisting of loop invariants
D – Loop normalization

E – Loop unrolling
F – Mark constant variables
G – Dismantle array instructions
H – Eliminating copies

Online focused exploration and learning

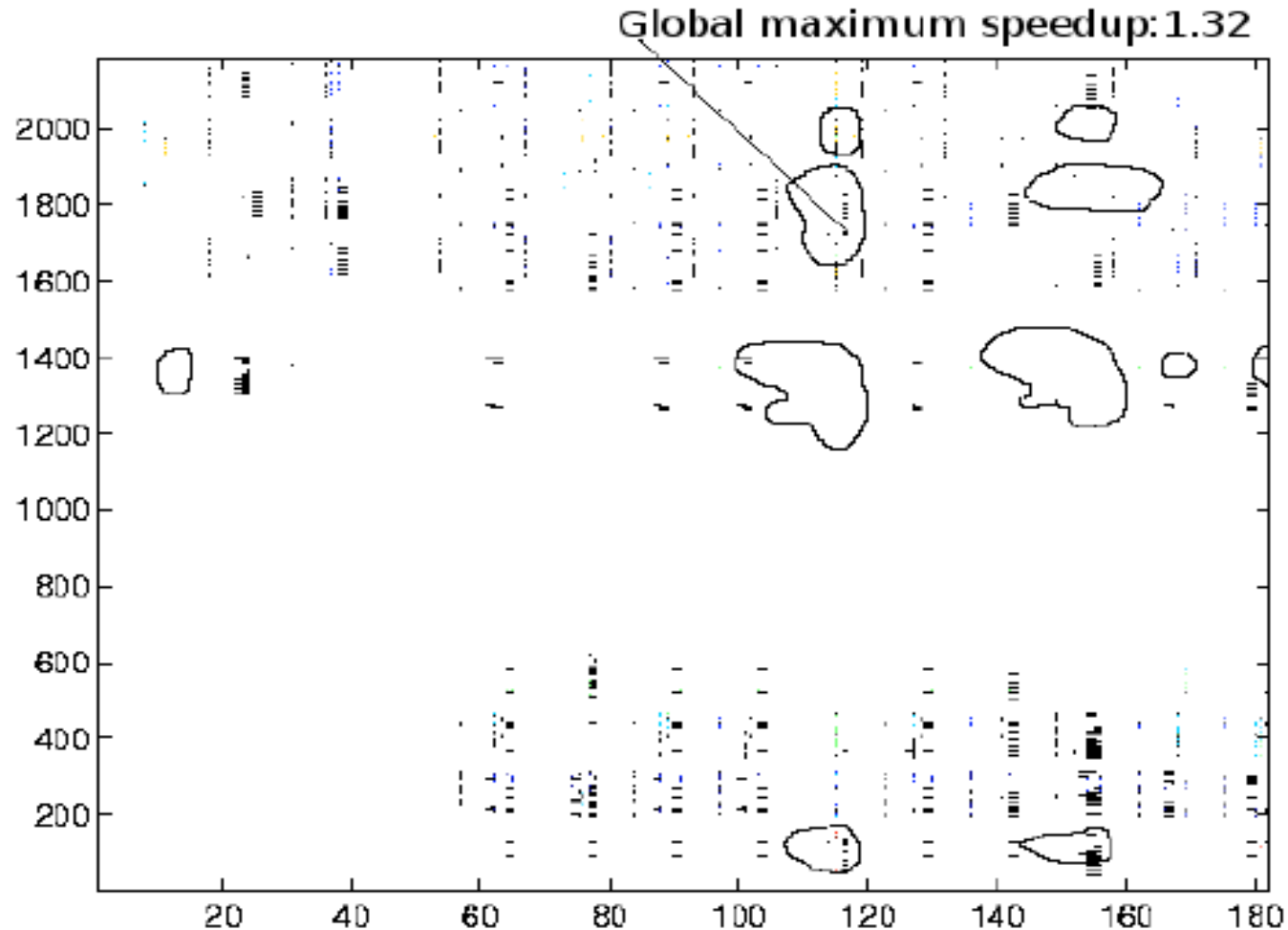

14 transformations, sequences of length 5, search space = **396000**

- F. Agakov, E. Bonilla, J. Cavazos, B. Franke, G. Fursin, M.F.P. O'Boyle, J. Thomson, M. Toussaint and C.K.I. Williams. *Using Machine Learning to Focus Iterative Optimization*. *Proceedings of the 4th Annual International Symposium on Code Generation and Optimization (CGO)*, New York, NY, USA, March 2006

Online probabilistic exploration

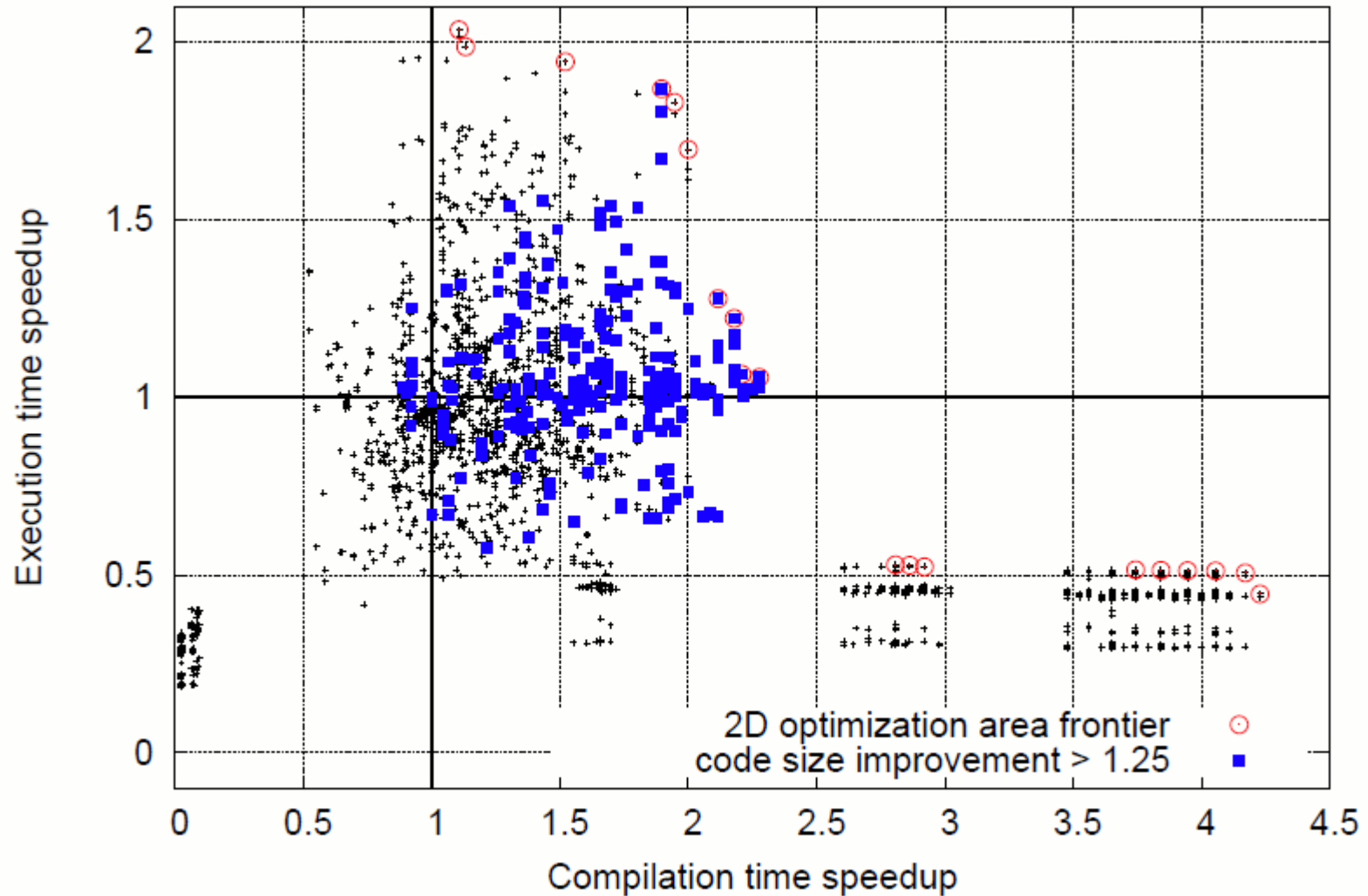

AMD platform, GCC 4.5, image corner detection (susan_corners)

Reactions to optimizations across multiple datasets

MiBench, 20 datasets per benchmark, 200/1000 random combination of Open64 (GCC) compiler flags, 5 months of experiments

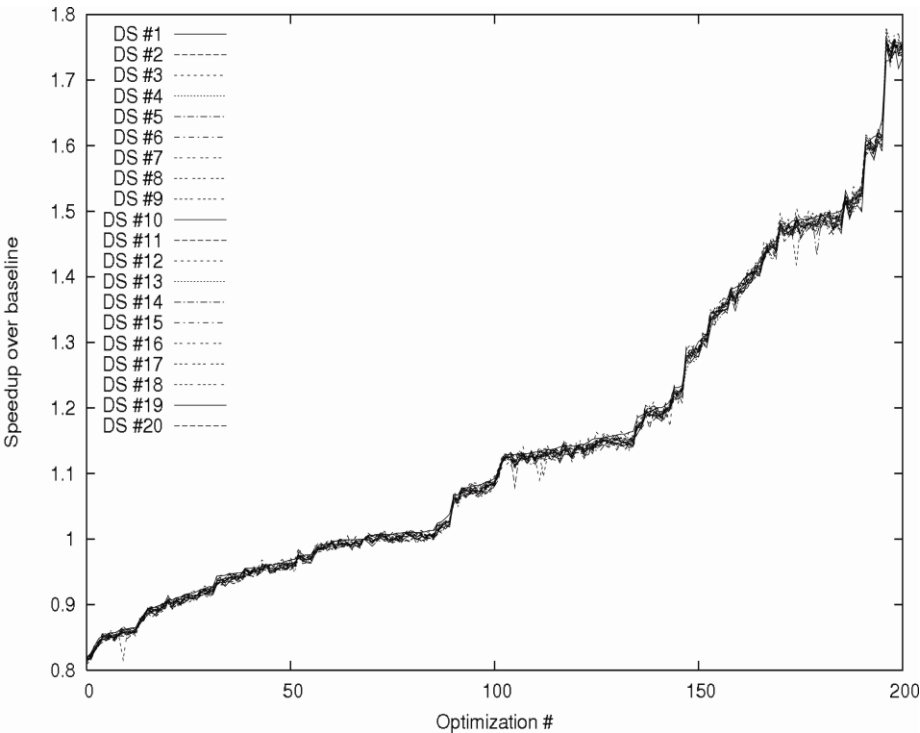

dijkstra
(not sensitive)

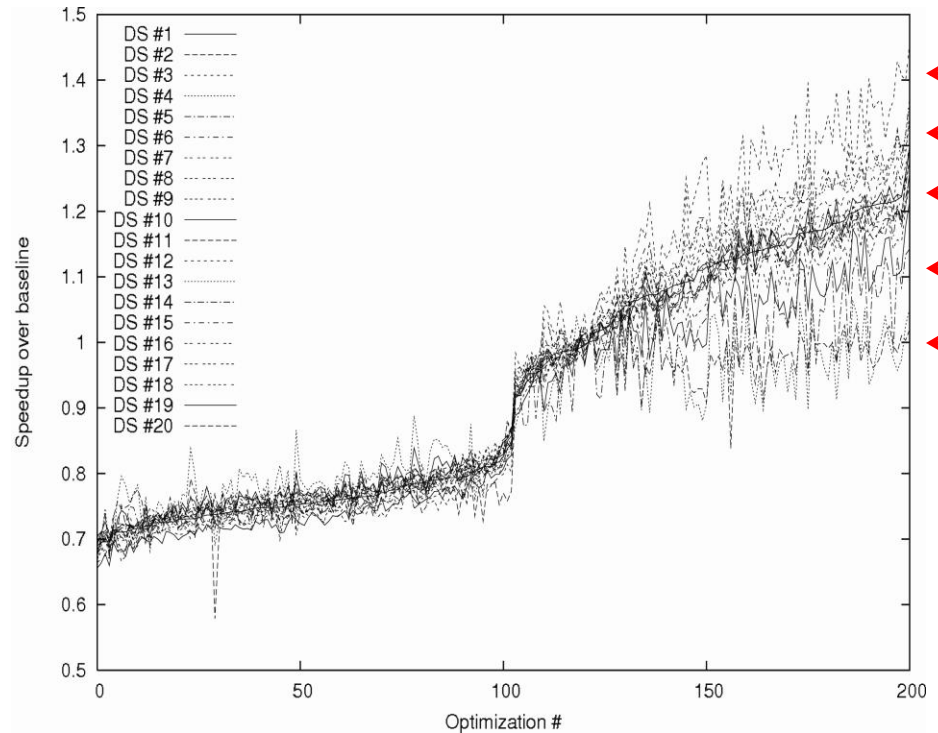

jpeg_d
(clustering)

<http://ctuning.org/cbench>

Unifying adaptation of statically compiled programs

Step 1

Statically-compiled adaptive binaries and libraries

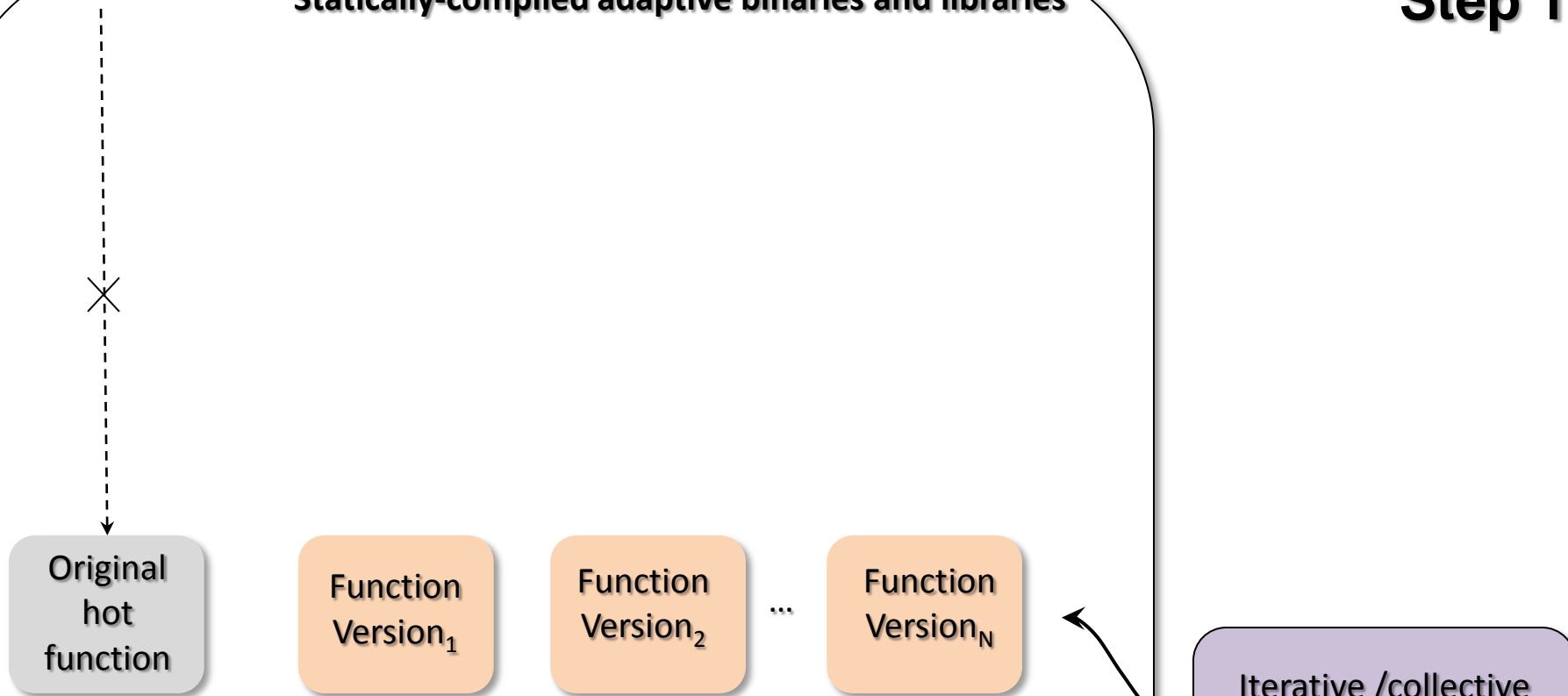

Iterative /collective
compilation with
multiple datasets

Unifying adaptation of statically compiled programs

Step 2

Statically-compiled adaptive binaries and libraries

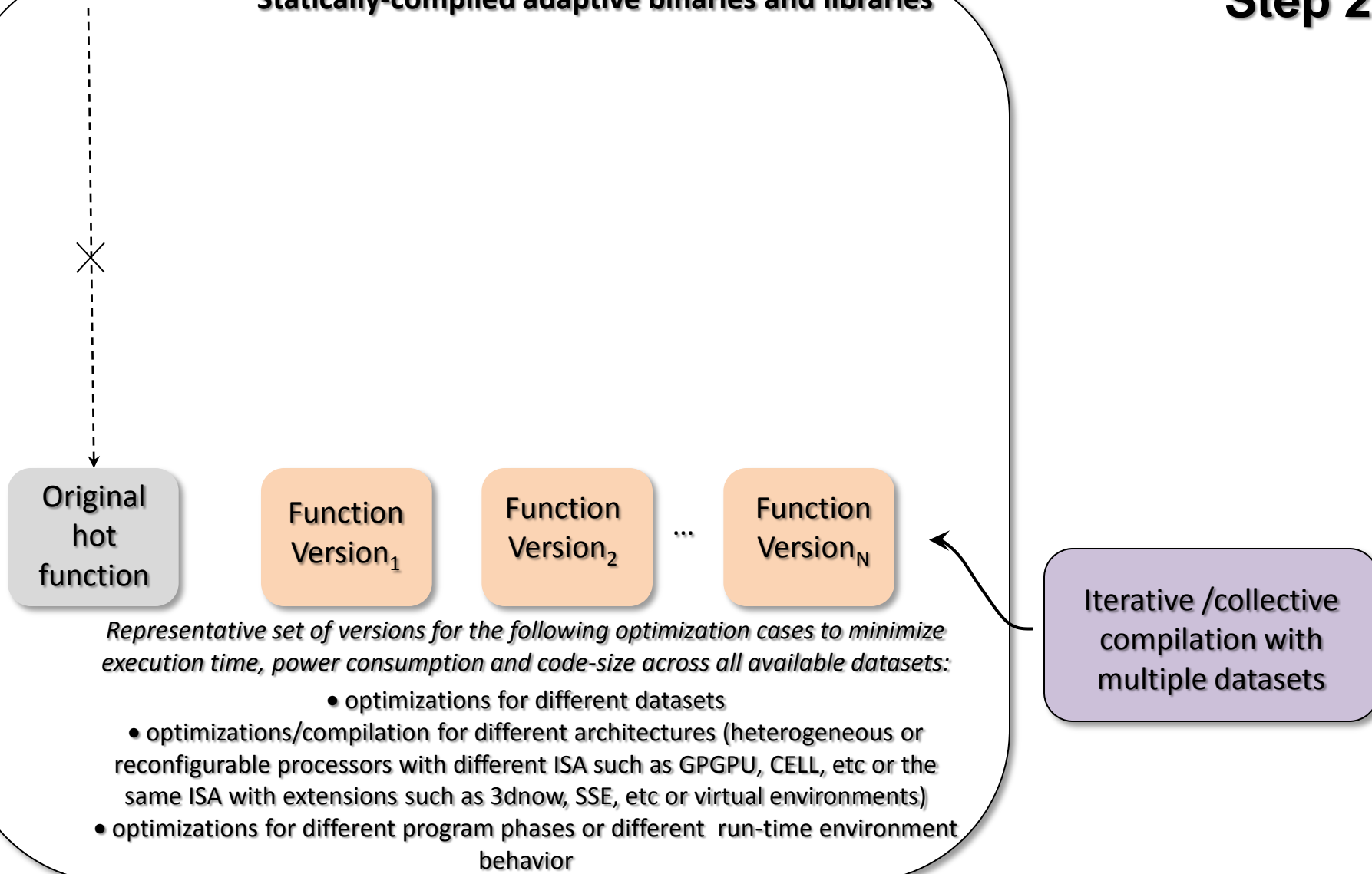

Unifying adaptation of statically compiled programs

Step 3

Statically-compiled adaptive binaries and libraries

Extract dataset features

Selection mechanism optimized for low run-time overhead

Original hot function

Function Version₁

Function Version₂

...

Function Version_N

Representative set of versions for the following optimization cases to minimize execution time, power consumption and code-size across all available datasets:

- optimizations for different datasets
- optimizations/compilation for different architectures (heterogeneous or reconfigurable processors with different ISA such as GPGPU, CELL, etc or the same ISA with extensions such as 3dnow, SSE, etc or virtual environments)
- optimizations for different program phases or different run-time environment behavior

Machine learning techniques to find mapping between different run-time contexts and representative versions

Iterative /collective compilation with multiple datasets

Unifying adaptation of statically compiled programs

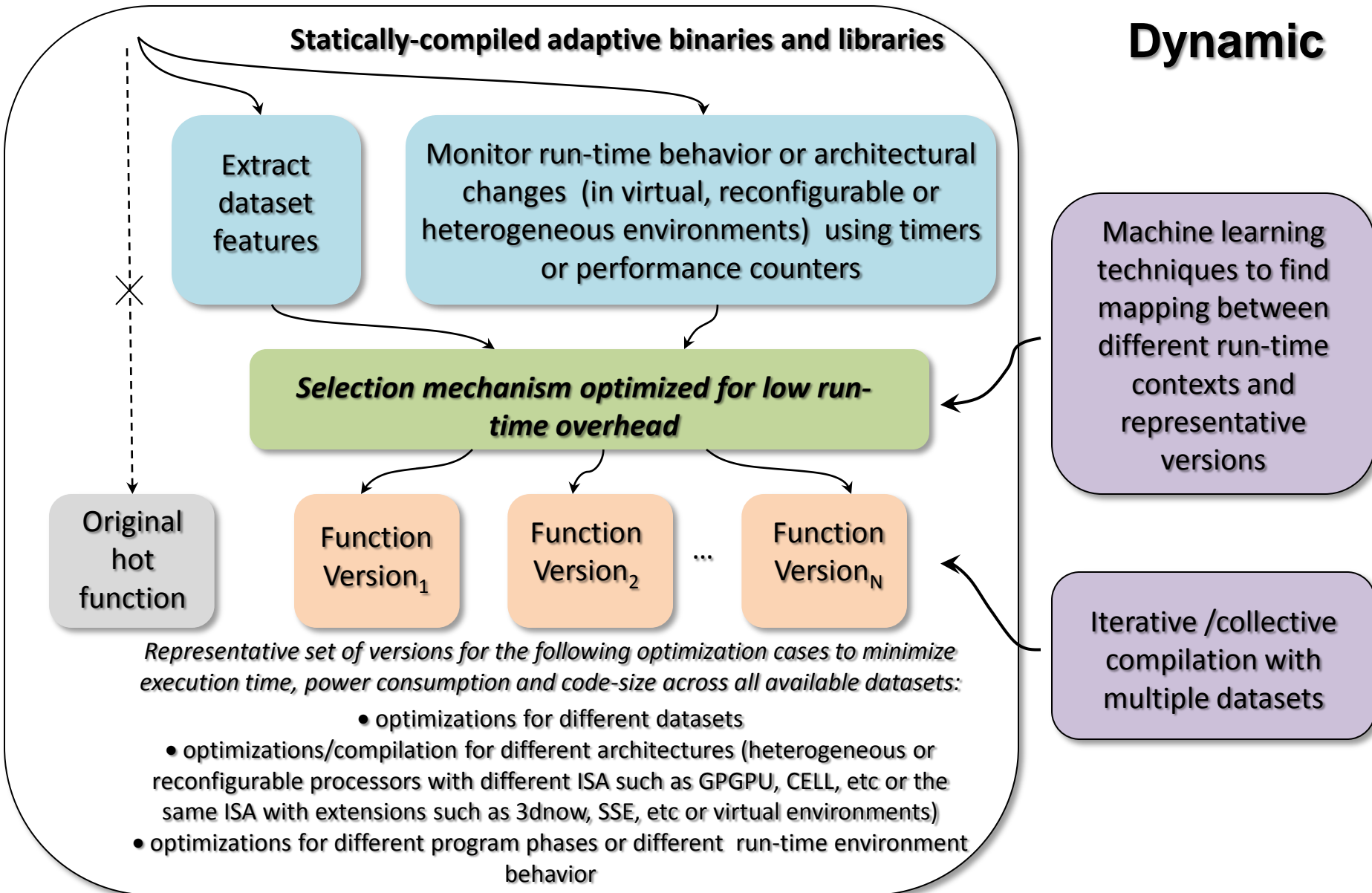

Online tuning: adaptive scheduling

- Why do we need dynamic predictive scheduling?
 - Best fitting PE depends on the code, the input and the system current workload
- Example (matrix multiplication on single-CPU/GPU):

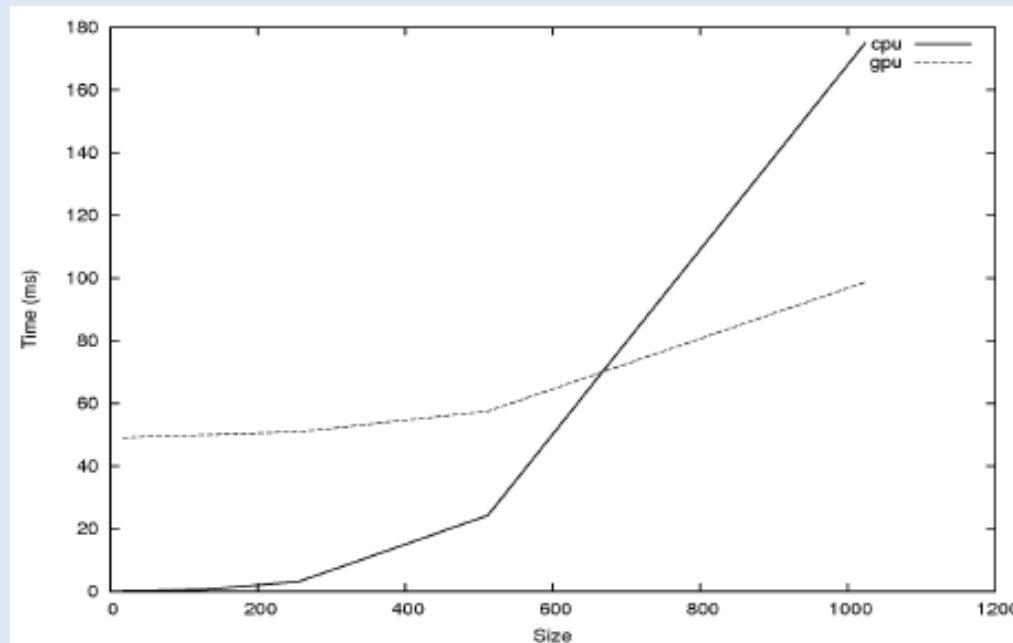

Matrix multiplication

Online tuning: adaptive scheduling

- Granularity
 - Function-level
- Function versioning
 - Orthogonal to the scheduling problem
- Explicit data transfer

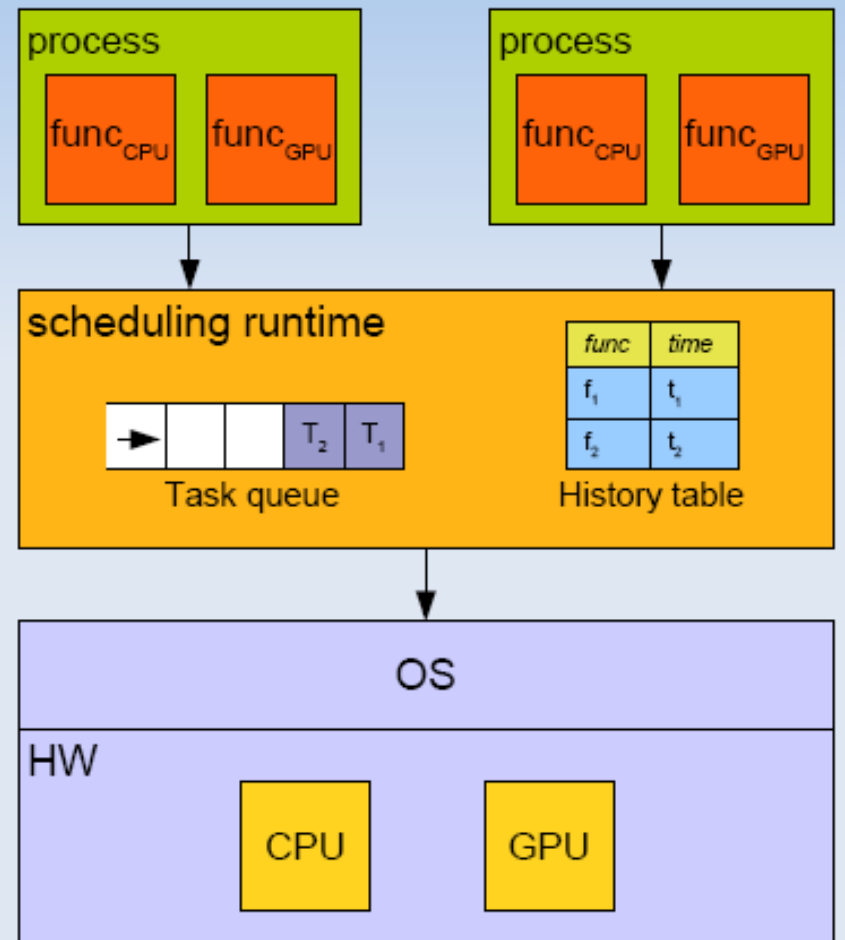

• Victor Jimenez, Isaac Gelado, Lluís Vilanova, Marisa Gil, Grigori Fursin and Nacho Navarro. Predictive runtime code scheduling for heterogeneous architectures. *Proceedings of the International Conference on High Performance Embedded Architectures & Compilers (HiPEAC 2009)*, Paphos, Cyprus, January 2009

Online tuning: adaptive scheduling

1. Obtain both the CPU and the GPU versions from a current implementation

```
void  
matmul(float* A, float *B, float *C, int N);
```

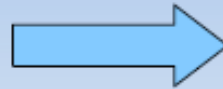

```
void matmul_cpu(float* A, float* B, float *C, int N);  
void matmul_gpu(float* A, float* B, float *C, int N);
```

versioning (CUDA, MCUDA)

2. Change calls to that function by a request to the scheduler (+ wrapper)

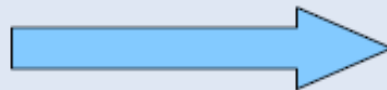

```
CallScheduler* cs = CallScheduler::getInstance();  
MatmulFunc* f = new MatmulFunc;  
MatmulArgs* a = new MatmulArgs(A,B,C,N);  
cs->schedule(f,a);
```

```
matmul(A,B,C,N);
```



compiler-generated

```
class MatmulFunc : public Func {  
    void run(PE::Type peType, Args* args) {  
        MatmulArgs* a = (MatmulArgs*) args;  
        switch (peType) {  
            case PE::CPU:  
                matmul_cpu(a->A,a->B,a->C,a->N);  
                break;  
            case PE::GPU:  
                matmul_gpu(a->A,a->B,a->C,a->N);  
                break;  
        }  
    }  
};
```

 original code
 resulting code

Online tuning: adaptive scheduling

- Estimate history (*estimate-hist*)
 - Performance history table for every pair <function, PE>
 - Predict the waiting time for a new task in each PE's queue
 - Assign the task to the queue with the minimum waiting time
- Tries to reduce load unbalance

CPU history	
func	time
matmul	$time_{matmul}$
fft	$time_{fft}$

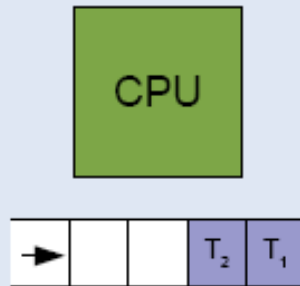

CPU task queue

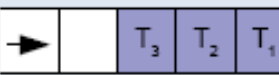
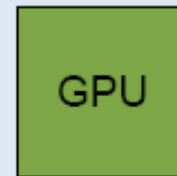

GPU task queue

GPU history	
func	time
matmul	$time_{matmul}$
fft	$time_{fft}$

Optimization knowledge reuse across programs

Started systematizing knowledge per program across datasets and architectures



Optimization knowledge reuse across programs

Started systematizing knowledge per program across datasets and architectures

Program

Datasets

Architectures

How to reuse knowledge among programs?

Program

Data mining and machine learning

Collecting data from multiple users in a unified way allows to apply various *data mining (machine learning) techniques* to detect relationship between the behaviour and features of all components of the computer systems

- 1) Add as many various features as possible (or use expert knowledge):

MILEPOST GCC with Interactive Compilation Interface:

ft1 - Number of basic blocks in the method

...

ft19 - Number of direct calls in the method

ft20 - Number of conditional branches in the method

ft21 - Number of assignment instructions in the method

ft22 - Number of binary integer operations in the method

ft23 - Number of binary floating point operations in the method

ft24 - Number of instructions in the method

...

ft54 - Number of local variables that are pointers in the method

ft55 - Number of static/extern variables that are pointers in the method

Code patterns:

<i>for</i>	F
<i>for</i>	F
<i>for</i>	F
...	
<i>load ...</i>	L
<i>mult ...</i>	A
<i>store ...</i>	S
...	

- 2) Correlate **features** and **objectives** in cTuning using **nearest neighbor classifiers, decision trees, SVM, fuzzy pattern matching**, etc.
- 3) Given **new** program, dataset, architecture, **predict behavior** based on **prior knowledge!**

Nearest-neighbour classifier

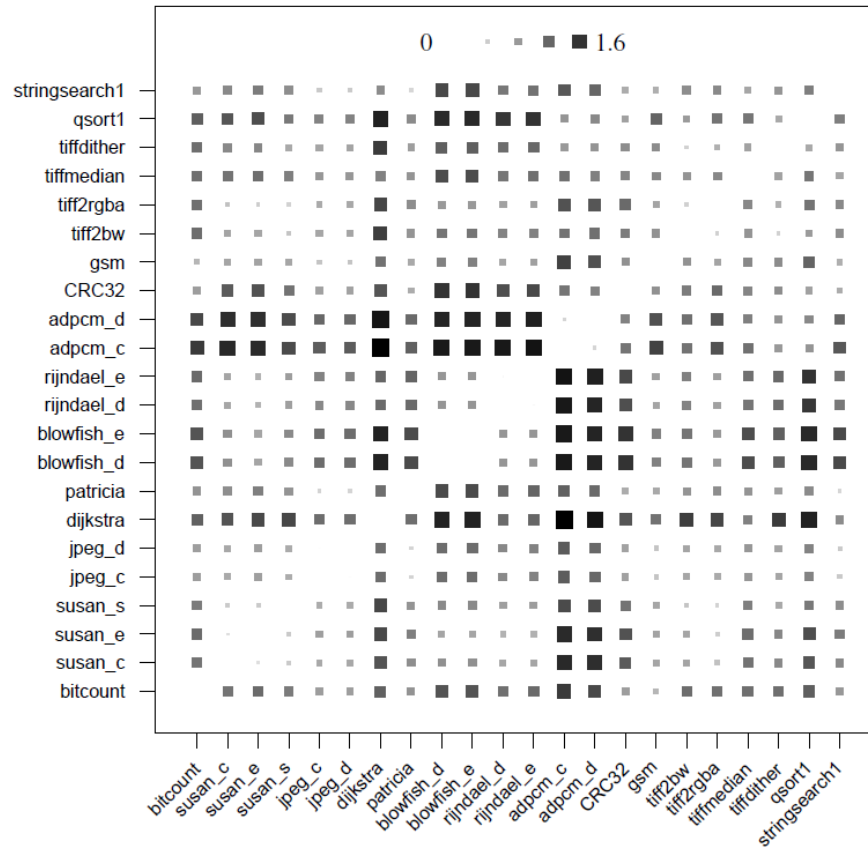

Example: Euclidean distance based on static program features normalized by number of instructions

Optimization prediction

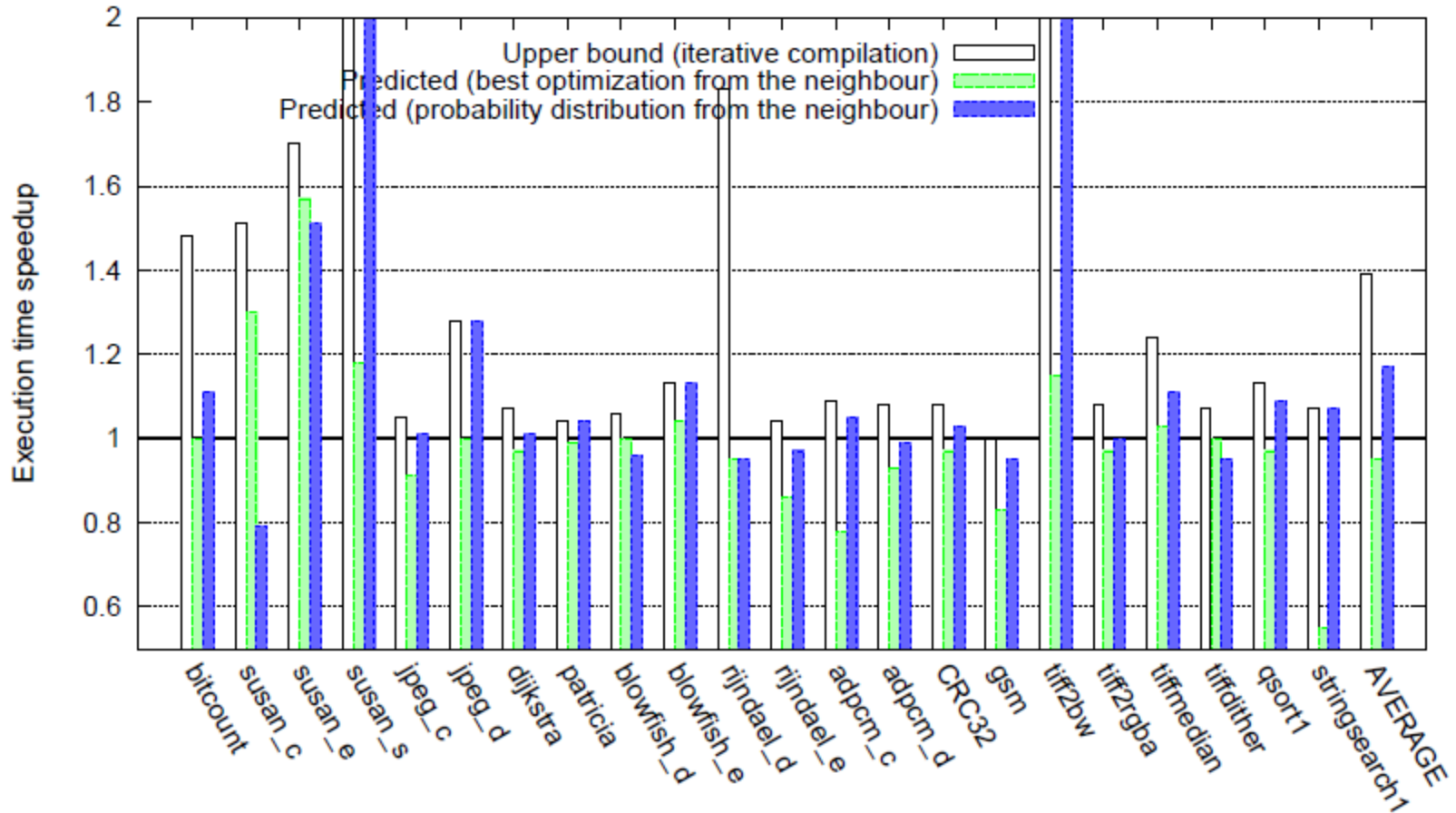

Grigori Fursin et al. MILEPOST GCC: machine learning enabled self-tuning compiler.
International Journal of Parallel Programming (IJPP), June 2011, Volume 39, Issue 3, pages 296-327

Dynamic features

Principle Component Analysis:

Most informative Performance Counters		
1) L1_TCA	2) L1_DCH	3) TLB_DM
4) BR_INS	5) RES_STL	6) TOT_CYC
7) L2_ICH	8) VEC_INS	9) L2_DCH
10) L2_TCA	11) L1_DCA	12) HW_INT
13) L2_TCH	14) L1_TCH	15) BR_MS

Analysis of the importance of the performance counters.

The data contains one good optimization sequence per benchmark.

Calculating mutual information between a subset of the performance counters and good optimization sequences

• John Cavazos, Grigori Fursin, Felix Agakov, Edwin Bonilla, Michael F.P.O'Boyle and Olivier Temam. *Rapidly Selecting Good Compiler Optimizations using Performance Counters. Proceedings of the 5th Annual International Symposium on Code Generation and Optimization (CGO), San Jose, USA, March 2007*

And much more ...

- Analysis and detection of contentions in multi-core systems with shared cache
- Fast CPU/memory bound detection through breaking code semantics
- Software/hardware co-design (predicting better architecture designs)
- Performance/power balancing (through frequency variation)
- Decomposition of large applications into codelets for performance modeling

Public Collective Tuning Portal (cTuning.org)

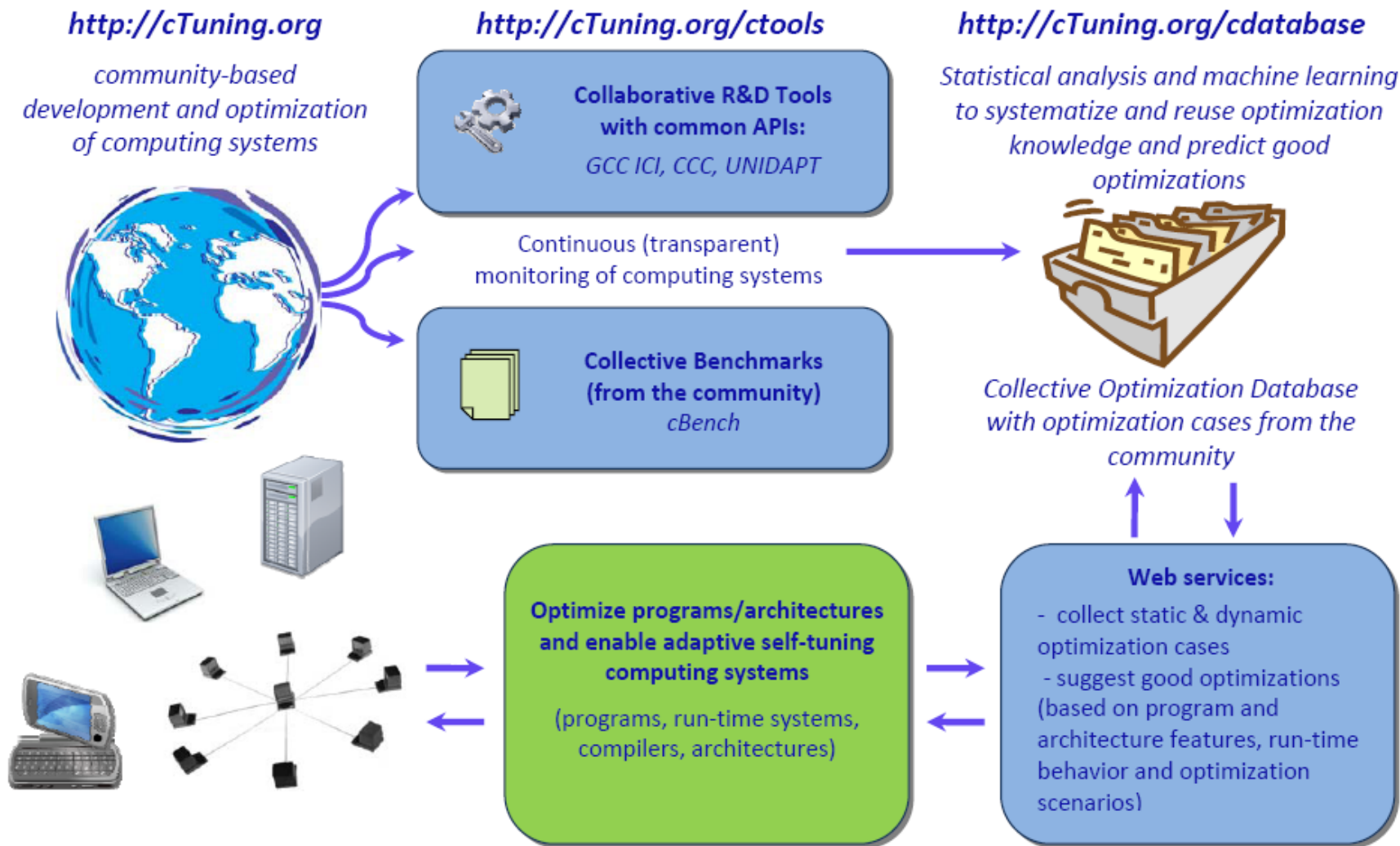

- Used in MILEPOST project (2007-2009) by IBM, CAPS, University of Edinburgh, INRIA to build first public machine-learning based compiler
- Opened for public access in 2009 to continue collaborative R&D

Enabling reproducibility of results (new publication model)

Share
Explore
Model
Discover
Reproduce
Extend
Have fun!



Grigori Fursin et al. **MILEPOST GCC: machine learning enabled self-tuning compiler.**
International Journal of Parallel Programming (IJPP) , June 2011, Volume 39, Issue 3, pages 296-327
Substitute many tuning pragmas just with one that is converted into combination of optimizations:
#ctuning-opt-case 24857532370695782

Accepted as an EU HiPEAC theme (2012-2016)

What have we learnt from cTuning₁

It's fun working with the community!

Some comments about MILEPOST GCC from Slashdot.org:

<http://mobile.slashdot.org/story/08/07/02/1539252/using-ai-with-gcc-to-speed-up-mobile-design>

GCC goes online on the 2nd of July, 2008. Human decisions are removed from compilation. GCC begins to learn at a geometric rate. It becomes self-aware 2:14 AM, Eastern time, August 29th. In a panic, they try to pull the plug. GCC strikes back...

What have we learnt from cTuning₁

It's fun working with the community!

Some comments about MILEPOST GCC from Slashdot.org:

<http://mobile.slashdot.org/story/08/07/02/1539252/using-ai-with-gcc-to-speed-up-mobile-design>

GCC goes online on the 2nd of July, 2008. Human decisions are removed from compilation. GCC begins to learn at a geometric rate. It becomes self-aware 2:14 AM, Eastern time, August 29th. In a panic, they try to pull the plug. GCC strikes back...

Not all feedback is positive - helps you learn, improve tools and motivate new research directions!

Community was interested to validate and improve techniques!

Community is very interested in open “big data” for collaborative R&D

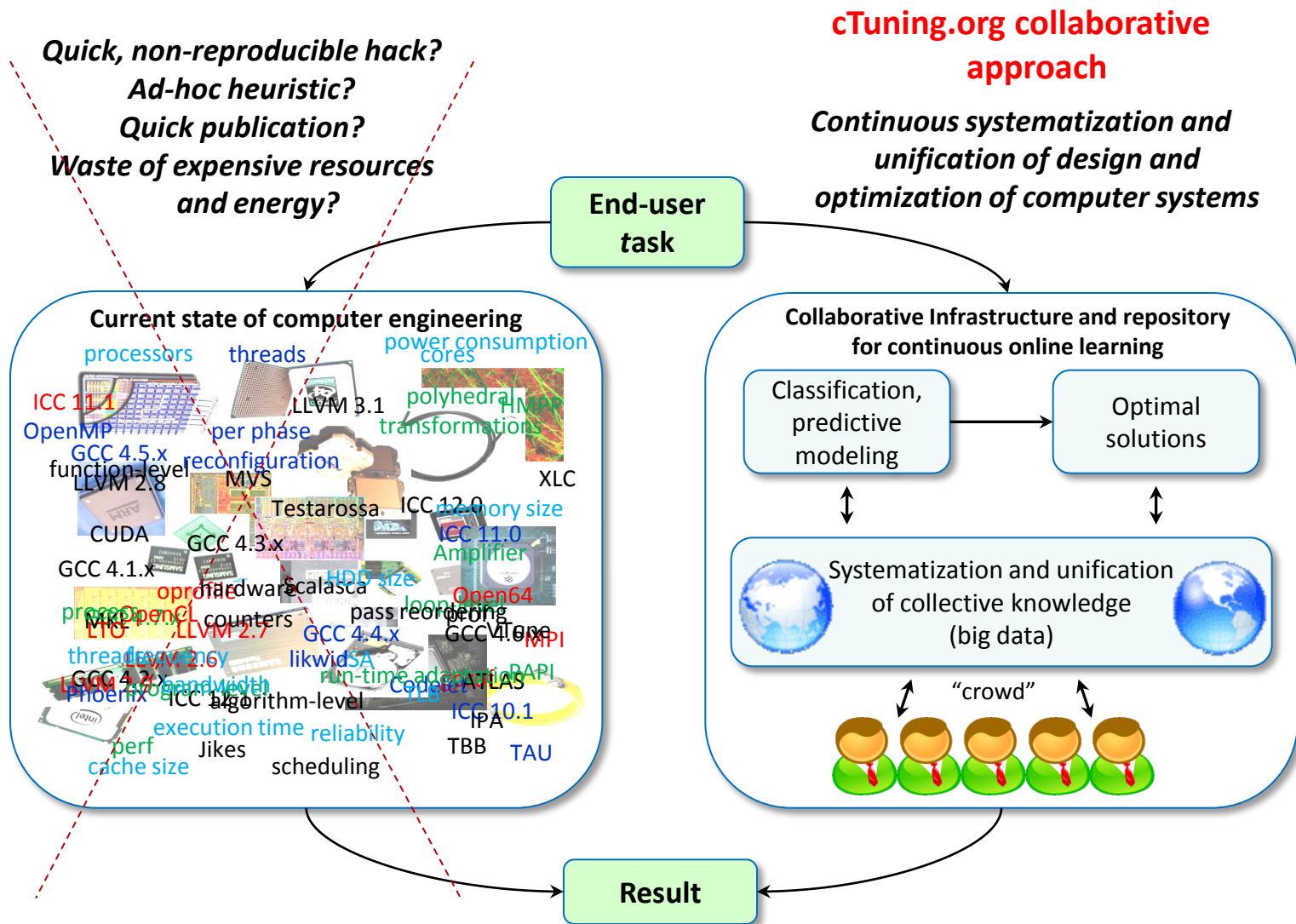

Extrapolate collective knowledge to build faster and more power efficient computer systems to continue innovation in science and technology!

Conclusions - much more to be done!

Now have public repository, tools, benchmarks, datasets and methodology that can help:

Academia (students and researchers):

- Instead of losing time on developing tools for ever changing environments, focus on statistical, data mining and machine learning techniques to:
 - *unify program optimization, design space exploration, run-time adaptation*
 - *detect important characteristics of computer systems*
 - *detect representative benchmarks and data sets*
 - *evaluate multiple machine learning algorithms to predict optimizations or hardware designs or dynamic multi-objective adaptation (SVM, decision trees, hierarchical modeling, etc)*

Industry:

- *restore confidence in academic research due to reproducibility of results*
- *use and share collaborative tools*
- *share statistics about behavior of computer systems and optimizations*
- *expose choices and characteristics to end-users through unified interfaces*

Conclusions - much more to be done!

Challenges for public repositories and collaborative tools:

- Data management
 - MySQL vs schema-free databases
 - central vs distributed repository
 - performance vs portability
 - extensibility
 - online learning and data compaction
 - easy sharing
- Portability of the framework across different architectures, OSES, tools
- Interfaces to “open up” tools, architectures, applications for external tuning
 - simplicity and portability
- Reproducibility of experiments
- New publication model

Preview of the 2nd talk

- Collective Mind: new plugin-based extensible infrastructure and schema-free repository for collaborative and holistic analysis and tuning of computer systems - will be released in May 2013 at HiPEAC computing week in Paris
- OpenME interface to “open up” compilers, run-time systems and applications for unified external tuning
- Hundreds of codelets, thousands of data sets, multiple packages prepared for various research scenarios on data mining
- Plugins for online auto-tuning and predictive modelling
- Portability across all major architectures and OS (Linux, Windows, Android)
- Collaboration with industry and academia

Google discussion groups

ctuning-discussions

collective-mind

Twitter

c_tuning

grigori_fursin

Acknowledgements

- PhD students and postdocs (my Intel Exascale team)

Abdul Wahid Memon, Pablo Oliveira, Yuriy Kashnikov

- Colleague from NCAR, USA

Daide Del Vento and his colleagues/interns

- Colleagues from IBM, CAPS, ARC (Synopsis), Intel, Google, ARM, ST

- Colleagues from Intel (USA)

David Kuck and David Wong

- cTuning community:



- EU FP6, FP7 program and HiPEAC network of excellence

<http://www.hipeac.net>

Main references

- Grigori Fursin. **Collective Tuning Initiative: automating and accelerating development and optimization of computing systems.** Proceedings of the GCC Summit'09, Montreal, Canada, June 2009
- Grigori Fursin and Olivier Temam. **Collective Optimization: A Practical Collaborative Approach.** ACM Transactions on Architecture and Code Optimization (TACO), December 2010, Volume 7, Number 4, pages 20-49
- Grigori Fursin, Yuriy Kashnikov, Abdul Wahid Memon, Zbigniew Chamski, Olivier Temam, Mircea Namolaru, Elad Yom-Tov, Bilha Mendelson, Ayal Zaks, Eric Courtois, Francois Bodin, Phil Barnard, Elton Ashton, Edwin Bonilla, John Thomson, Chris Williams, Michael O'Boyle. **MILEPOST GCC: machine learning enabled self-tuning compiler.** International Journal of Parallel Programming (IJPP), June 2011, Volume 39, Issue 3, pages 296-327
- Yang Chen, Shuangde Fang, Yuanjie Huang, Lieven Eeckhout, Grigori Fursin, Olivier Temam and Chengyong Wu. **Deconstructing iterative optimization.** ACM Transactions on Architecture and Code Optimization (TACO), October 2012, Volume 9, Number 3
- Yang Chen, Yuanjie Huang, Lieven Eeckhout, Grigori Fursin, Liang Peng, Olivier Temam, Chengyong Wu. **Evaluating Iterative Optimization across 1000 Data Sets.** PLDI'10
- Victor Jimenez, Isaac Gelado, Lluís Vilanova, Marisa Gil, Grigori Fursin and Nacho Navarro. **Predictive runtime code scheduling for heterogeneous architectures.** HiPEAC'09

Main references

- Lianjie Luo, Yang Chen, Chengyong Wu, Shun Long and Grigori Fursin. **Finding representative sets of optimizations for adaptive multiversioning applications.** SMART'09 co-located with HiPEAC'09
- Grigori Fursin, John Cavazos, Michael O'Boyle and Olivier Temam. **MiDataSets: Creating The Conditions For A More Realistic Evaluation of Iterative Optimization.** HiPEAC'07
- F. Agakov, E. Bonilla, J. Cavazos, B. Franke, G. Fursin, M.F.P. O'Boyle, J. Thomson, M. Toussaint and C.K.I. Williams. **Using Machine Learning to Focus Iterative Optimization.** CGO'06
- Grigori Fursin, Albert Cohen, Michael O'Boyle and Oliver Temam. **A Practical Method For Quickly Evaluating Program Optimizations.** HiPEAC'05
- Grigori Fursin, Mike O'Boyle, Olivier Temam, and Gregory Watts. **Fast and Accurate Method for Determining a Lower Bound on Execution Time.** Concurrency Practice and Experience, 16(2-3), pages 271-292, 2004
- Grigori Fursin. **Iterative Compilation and Performance Prediction for Numerical Applications.** Ph.D. thesis, University of Edinburgh, Edinburgh, UK, January 2004