



HAL
open science

D4.3.2 Report on IOT Living Labs Continuous Exploration and Evaluation (interim version)

Marco Tiemann, Atta Badii, Matthias Kalverkamp, Brigitte Trousse,
Anne-Laure Negri, Caroline Tiffon, Sauro Vinci

► **To cite this version:**

Marco Tiemann, Atta Badii, Matthias Kalverkamp, Brigitte Trousse, Anne-Laure Negri, et al.. D4.3.2 Report on IOT Living Labs Continuous Exploration and Evaluation (interim version). [Technical Report] Livrable D4.3.2, 2012. hal-00796113

HAL Id: hal-00796113

<https://inria.hal.science/hal-00796113v1>

Submitted on 7 Mar 2013

HAL is a multi-disciplinary open access archive for the deposit and dissemination of scientific research documents, whether they are published or not. The documents may come from teaching and research institutions in France or abroad, or from public or private research centers.

L'archive ouverte pluridisciplinaire **HAL**, est destinée au dépôt et à la diffusion de documents scientifiques de niveau recherche, publiés ou non, émanant des établissements d'enseignement et de recherche français ou étrangers, des laboratoires publics ou privés.

	ELLIOT – Experiential Living Lab for the Internet Of Things	Project N.	258666
	D4.3.2 – Report on IOT Living Labs Continuous Exploration and Evaluation (interim)	Date	31.08.2012





Experiential Living Lab for the Internet Of Things

D4.3.2

Report on IOT Living Labs Continuous Exploration and Evaluation (interim)

Deliverable data

Deliverable no & name	D4.3.2 – Report on IOT Living Labs Continuous Exploration and Evaluation (interim)		
Main Contributors	UoR, BIBA, HSR, INRIA		
Other Contributors	FING, VULOG		
Deliverable Nature	Report		
Dissemination level	PU	Public	X
	PP	Restricted to other programme participants (including the Commission Services)	
	RE	Restricted to a group specified by the consortium (including the Commission Services)	
	CO	Confidential, only for members of the consortium (including the Commission Services)	
Date	31.08.2012		
Status	Final		



	ELLIOT – Experiential Living Lab for the Internet Of Things	Project N.	258666
	D4.3.2 – Report on IOT Living Labs Continuous Exploration and Evaluation (interim)	Date	31.08.2012

Table of Contents

1	EXECUTIVE SUMMARY [UOR]	5
2	INTRODUCTION [UOR]	6
2.1	PURPOSE, INTENDED AUDIENCE AND SCOPE	6
2.2	APPLICABLE DOCUMENTS	6
3	LOGISTICS [BIBA]	8
3.1	EXPERIMENT OVERVIEW	8
3.1.1	<i>Experiment Description</i>	8
3.1.2	<i>KSB Instantiation</i>	9
3.1.3	<i>Connection to ELLIOT Platform</i>	10
3.2	EXPERIMENT LESSONS LEARNED UND UPDATES RELATIVE TO D4.3.1	11
3.2.1	<i>Design Changes</i>	11
3.2.2	<i>Data Collection Changes</i>	13
3.2.3	<i>Data Analysis Changes</i>	15
3.3	PARTICIPANTS	18
3.4	DATA COLLECTION	21
3.4.1	<i>Sensor Data</i>	21
3.4.2	<i>Observation and Survey Data</i>	24
3.5	DATA ANALYSIS	26
3.5.1	<i>Sensor Data Analysis</i>	26
3.5.2	<i>Observation and Questionnaire Data Analysis</i>	30
3.5.3	<i>Data-KSB Mapping</i>	42
3.6	RESULTS AND INFERENCES	44
3.6.1	<i>Experiment Outcomes</i>	44
3.6.2	<i>KSB Analysis</i>	46
4	CITY OF THE FUTURE USE CASE [HSR]	47
4.1	EXPERIMENT OVERVIEW	47
4.1.1	<i>Experiment Description</i>	47
4.1.2	<i>KSB Instantiation</i>	51
4.1.3	<i>Connection to ELLIOT Platform</i>	52
4.2	EXPERIMENT LESSONS LEARNED UND UPDATES RELATIVE TO D4.3.1	53
4.2.1	<i>Design Changes</i>	54
4.2.2	<i>Data Collection Changes</i>	54
4.2.3	<i>Data Analysis Changes</i>	55
4.3	PARTICIPANTS	56
4.4	DATA COLLECTION	57
4.4.1	<i>Sensor Data</i>	57
4.4.2	<i>Observation and Survey Data</i>	60
4.5	DATA PRE-PROCESSING AND DATA ANALYSIS	63
4.5.1	<i>Sensor Data Analysis</i>	63
4.5.2	<i>Observation and Questionnaire Data Analysis</i>	66
4.5.3	<i>Data-KSB Mapping</i>	72
5	GREEN SERVICES [INRIA]	73
5.1	EXPERIMENT OVERVIEW	73
5.1.1	<i>Experiment Description</i>	75
5.1.2	<i>KSB Instantiation</i>	80
5.1.3	<i>Connection to ELLIOT Platform</i>	81
5.2	EXPERIMENT LESSONS LEARNED AND UPDATES RELATIVE TO D4.3.1	83
5.2.1	<i>Design Changes</i>	83
5.2.2	<i>Data Collection Changes</i>	84
5.2.3	<i>Data Analysis Changes</i>	84
5.3	PARTICIPANTS	85

	ELLIOT – Experiential Living Lab for the Internet Of Things	Project N.	258666
	D4.3.2 – Report on IOT Living Labs Continuous Exploration and Evaluation (interim)	Date	31.08.2012

5.4	DATA COLLECTION	85
5.4.1	<i>Sensor Data</i>	85
5.4.2	<i>Observation and Survey Data</i>	85
5.5	DATA PRE-PROCESSING AND DATA ANALYSIS	90
5.5.1	<i>Sensor Data Analysis</i>	90
5.5.2	<i>Observation and Questionnaire Data Analysis</i>	90
5.5.3	<i>Data-KSB Mapping</i>	92
5.5.4	<i>Usage of ELLIOT Data Analysis Features (experimentation 2)</i>	97
5.6	RESULTS AND INFERENCES.....	97
5.6.1	<i>Experiment Outcomes</i>	97
5.6.2	<i>KSB Analysis</i>	99
5.6.3	<i>Conclusion</i>	114
6	CONCLUSIONS [UOR]	116
7	REFERENCES	117
8	APPENDIX: GREEN SERVICES USE CASE [INRIA]	118
8.1	USER PROFILES	118
8.1.1	<i>Experimentation 1</i>	118
8.1.2	<i>Experimentation 2</i>	129
8.2	QUESTIONNAIRE.....	132
8.3	GREEN SERVICES: IOT SENSOR DATA COLLECTION AND ANALYSIS	135
8.3.1	<i>Air quality Air PACA fixed sensors (resp: Inria)</i>	136
8.3.2	<i>Green watches: FING (resp) + INRIA</i>	137
8.3.3	<i>Electric vehicles based sensors: VUIOG (resp)</i>	140
8.3.4	<i>Air quality POLLUX stations: FING (resp) + Inria</i>	144
8.3.5	<i>Air quality AxIS device: INRIA (resp)</i>	146
9	APPENDIX: LOGISTICS USE CASE [BIBA]	150
9.1	QUESTIONNAIRES	150
9.1.1	<i>Briefing Questionnaire</i>	150
9.1.2	<i>Debriefing Questionnaire</i>	152

	ELLIOT – Experiential Living Lab for the Internet Of Things	Project N.	258666
	D4.3.2 – Report on IOT Living Labs Continuous Exploration and Evaluation (interim)	Date	31.08.2012

1 Executive Summary [UOR]

This deliverable reports on the achievements and the current status of the ELLIOT use cases and scenarios in the logistics, city of the future and green services domains. As an interim deliverable, D4.3.2 follows up on work reported on in deliverable D4.3.1 and will be followed by the final deliverable D4.3.3. This deliverable focuses on providing information on the work undertaken by the use case partners after the completion of D4.3.2.

For each of the represented usage scenarios, the involved use case partners report on

- the overall experiments carried out,
- experiment lessons learned and updates relative to previous work reported on in D4.3.1,
- experiment participants,
- data collection,
- data pre-processing and data analysis, and
- results and inferences.

Additional technical information on ongoing experiments is provided in the form of appendices at the end of this deliverable. The introduction section outlines the scope of this deliverable; the conclusions section summarises achievements and generalisable results across the three use cases.

	ELLIOT – Experiential Living Lab for the Internet Of Things	Project N.	258666
	D4.3.2 – Report on IOT Living Labs Continuous Exploration and Evaluation (interim)	Date	31.08.2012

2 Introduction [UoR]

The main goal of the ELLIOT (Experiential Living Labs for the Internet Of Things) project is to develop IoT technologies and Ambient Intelligence (AmI) services by and for users/citizens through the design of a set of Knowledge-Social-Business (KSB) Experience Models and their implementation in an innovative ELLIOT Experiential Platform operating as a knowledge and experience-gathering environment. The early involvement of users/citizens, as recommended in the ICT Work-programme, is conducted according to the precepts of the Open User-Centred Innovation paradigm and through the co-creation of and experimentation using the Living Lab approach which aims to involve users/citizens in research and innovation pathways. This combination of market pull and technology push is expected to have a positive impact on the development and adoption of IoT technologies and innovative services.

2.1 Purpose, Intended Audience and Scope

The purpose of this deliverable is to document the interim results of WP4 in order to document and disseminate the research and development that has been carried out within and beyond the ELLIOT project. Within the project this deliverable is of particular relevance for Work Packages 1, 2 and 7. For Work Package 2, this deliverable sets out feedback regarding the technical ELLIOT experiential platform. For Work Package 1, this deliverable provides feedback regarding the ELLIOT KSB model. The presented results are also expected to provide insights for use case partners represented in Work Package 7.

The near-term intended audience of this deliverable is the ELLIOT project partner community, where in particular partners involved in the aforementioned work packages are expected to benefit. The mid-to-long term intended audience of this deliverable furthermore extends to Living Labs using ELLIOT project outcomes in the field; for them, this document should convey ways in which ELLIOT can be applied as well as lessons learned that may help them in avoiding potential problems when applying ELLIOT in practice.

2.2 Applicable Documents

The following ELLIOT deliverables in particular apply and are of importance for this deliverable D4.3.2:

AD(1).D1.1 KSB Experience Model Overall Framework

AD(2).D2.1.1 User Requirements and Architectural Design (first version)

	ELLIOT – Experiential Living Lab for the Internet Of Things	Project N.	258666
	D4.3.2 – Report on IOT Living Labs Continuous Exploration and Evaluation (interim)	Date	31.08.2012

AD(3).D4.1 Specification of the IoT Use Cases

AD(4).D4.2.1 Report on IoT Living Labs Methodology and Tools

AD(5).D4.3.1 Report on IOT Living Labs Continuous Exploration and Evaluation (initial)

AD(6).D6.1 Project Handbook and Quality Plan

	ELLIOT – Experiential Living Lab for the Internet Of Things	Project N.	258666
	D4.3.2 – Report on IOT Living Labs Continuous Exploration and Evaluation (interim)	Date	31.08.2012

3 Logistics [BIBA]

3.1 Experiment Overview

3.1.1 *Experiment Description*

The logistics use case, set up within the BIBA logistics Living Lab (LL) environment, follows an improvement approach in the domain of intra-logistics. From discussion with experts, a specific focus on intra-logistics processes has been derived for ELLIOT. Thus the main goal of the use case is to create a service that identifies risk situations along an intra-logistics process chain and encourages stakeholders to freely explore alternatives for increasing safety and security for operators and goods.

During the Living Lab process related to this use case, settings for the risk monitoring application are developed. The experimentation activity is performed using this risk monitoring application. As presented in D4.2.1, a Serious Game (SG) and a sensor tool kit support the discussion and translation process which leads from the idea creation (co-creation) to the IoT service (exploration and experimentation); the process is monitored and guided by ongoing evaluations. The sensor toolkit combines hardware sensors (mainly Arduino) and a graphical user interface (GUI).¹

During the exploration phase, the sensor toolkit with its GUI is used. Users are able to explore and to configure the service via the GUI, and they create individual risk logics. Activities carried out at a theoretical level during the exploration are then transferred into experimentation: the created service is attached to a forklift in a shop floor area and tested under real-life conditions.

The toolkit contains distributed wireless sensors or sensor clusters and a set of actuators, including for instance a display, an emergency light (orange), a horn and a ‘traffic signal’; furthermore, the toolkit (like the final service) provides e-mail and Twitter services which allow active communication directed to the Internet. Additionally, a web-interface for smart phone browsers will be provided to allow remote access to the service and specific sensors hosted by the service from the Internet.²

- Distributed wireless sensors or sensor clusters are attached to logistics objects (goods, pallets, forklifts, etc.) and workers.

¹ For more information about the Living Lab setup, please refer to ELLIOT deliverable D4.2.1.

² The sensor selection available from the Internet is reduced due to legal issues; e.g. sensors observing the physical status of personnel can already be a critical issue of the service. Such information, even if pseudonymised, will generally not be available from the outside.

	ELLIOT – Experiential Living Lab for the Internet Of Things	Project N.	258666
	D4.3.2 – Report on IOT Living Labs Continuous Exploration and Evaluation (interim)	Date	31.08.2012

- Actuators are provided to personnel, namely the forklift driver (working with the forklift, usually inside in the forklift driver cabin).

These sensors are meant to detect events that are related to certain risks. The kind of sensors used depends on the risk events defined in the Living Lab workshop(s). Sensors can currently capture position and acceleration, heartbeat, galvanic skin response (currently being trialled), temperature and humidity, RFID tags, vibration, GPS, surface pressure, air pressure, distance, light level, direction, tilt level (in 90 degree steps), noise level (more trialling needed), methane and alcohol gas concentration and speed.

Risk events consist of threshold values or ranges for sensors that should not be crossed or moved out of. Context data derived from data and the corresponding thresholds/ranges are calculated into risk values and are presented to the logistics operators via a small screen. Additionally, alternative actuators (see above) can be used to express risk values. For remote notification about risks messaging services (e-mail, Twitter) can be used. When threshold values are crossed, a message is posted by the registering object. Some risks and sensors can be observed remotely.

During the core experimentation it is observed whether the services created by the users reach a number of pre-defined goals. If the users want to reduce the number of incidents in which freight goods are damaged due to toppling, the actual number of such incidents is ascertained. Then it is observed whether the service facilitates a reduction of incidents. This would be one very important factor for the user experience of the service. However, more aspects are taken into account when the user experience with the service is investigated.

3.1.2 *KSB Instantiation*

To understand the user experience of the IoT service which is developed in the ELLIOT (logistics) Living Lab, the KSB model is used. Table 1 lists the selected KSB Properties for each of the three perspectives related to the logistics use case; this selection is based on the table presented in D4.3.1 and is the result of an ongoing refinement process which will be completed with the delivery of D4.3.3 at the end of the project. However, adjustments and especially extensions of this table for D4.3.3 will be made only after careful consideration. The properties currently considered to be the key components are those formatted in **bold** font style, the remaining properties (in *italic* font style) have been selected for further investigation. The activity that is required is to investigate the selected properties in order to understand better both (1) their relevance and expressiveness in relation to the case and (2) their measurability and measurement in the use case.

Table 1: Chosen KSB properties (Logistics Living Lab)

KSB	KSB name
K4.1	Human computer interaction
<i>K2.3</i>	<i>Attunement of affordances</i>
S7.1	Attractiveness
<i>S7.2</i>	<i>Appealingness</i>
B1.2	Performance Level
<i>B2.1</i>	<i>Reliability</i>
B4.6	Loyalty
<i>B5.2</i>	<i>Accessibility</i>
<i>B5.3</i>	<i>Availability</i>

For more details about the KSB adjustments, see Section 3.2.

3.1.3 Connection to ELLIOT Platform

The raw sensor data from the logistics use case sensor toolkit (as well as some qualified sensor data) is pulled in by the *Data Provider* located at the BIBA site. This pull is performed by the *Data Provider Client* that is part of the ELLIOT platform. Data is transferred through the ELLIOT middleware which then delivers this data to the ELLIOT core platform for storage, representation and computation of KSB analyses.

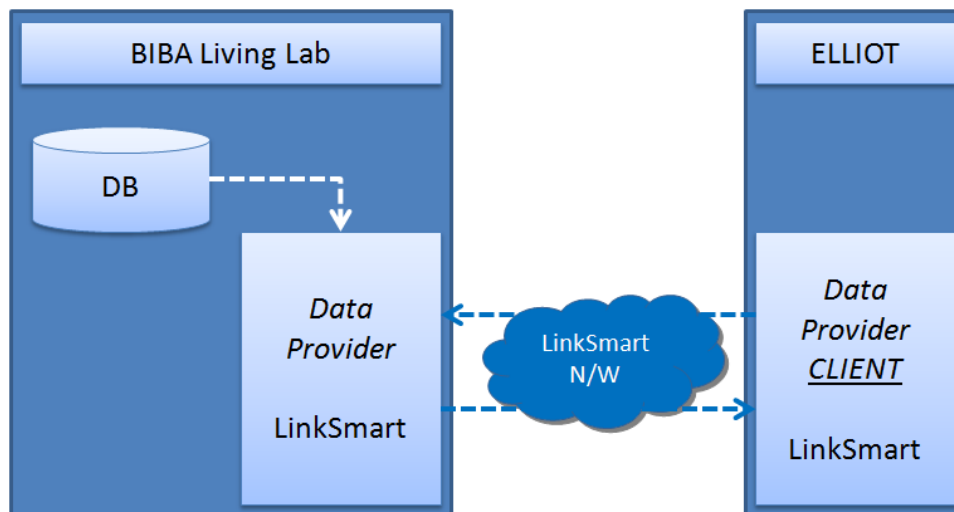



Figure 1: Logistics use case connection to ELLIOT platform via the LinkSmart ELLIOT middleware

	ELLIOT – Experiential Living Lab for the Internet Of Things	Project N.	258666
	D4.3.2 – Report on IOT Living Labs Continuous Exploration and Evaluation (interim)	Date	31.08.2012

At the BIBA site, a database is provided, which the Data Provider accesses based on the request from the Data Provider Client. The anonymisation module and the rule engine of the ELLIOT middleware are not currently being used in the logistics use case.

Once the data is available on the ELLIOT platform, Key Performance Indicators (KPIs) are defined based on the KSB instantiation and data which is collected. Depending on the quality of data aggregation (qualification) by Focus Lab the KPIs can be defined. As described in the relevant documents, the platform is used to select KSB properties and to prepare the rules, the scale and if applicable the weight for each KSB property.

3.2 Experiment Lessons Learned und Updates Relative to D4.3.1

The following improvements and changes have been made relative to D4.3.1 (for details see the following sections below):

- development of general metrics,
- adjustment of Living Lab iterations in terms of workshops to be carried out,
- refinement of KSB property and Indicator selection,
- increase of the proportion of automatically collected data relative to data collected by human observation,
- introduction of briefing and de-briefing questionnaires for each workshop,
- refinement of toolkit software to improve collected data streams.

3.2.1 Design Changes

3.2.1.1 Metrics

As noted earlier, KSB Property and KPI selections in ELLIOT are undergoing a constant refinement process. This goes alongside a refined view on data analysis. Whereas before a greater part of the analysis was based on observation data collected by human observers, the adjusted and improved approach focuses on data which comes directly from the service and can be analysed automatically to a greater extent. To reach this goal, general metrics have been developed. These metrics are used for evaluation and also partly for the KSB measurement. These metrics are ‘coverage’, ‘efficiency’, ‘efficacy’, ‘time spent in’ and ‘interaction’. They are used in different KSB Properties: efficiency and efficacy, for example, are used in the measurement of KSB property K4.1 Human Computer Interaction (see Section 3.5.1).

Coverage – expressed as % of the reference model that has been addressed, and possibly solved, in the activity. The metric can be computed as the number of addressed issues to the total number

	ELLIOT – Experiential Living Lab for the Internet Of Things	Project N.	258666
	D4.3.2 – Report on IOT Living Labs Continuous Exploration and Evaluation (interim)	Date	31.08.2012

of foreseen issues. In this case it is worth mentioning that if an aspect not originally foreseen, but relevant, is addressed, then the metric will provide a value that will exceed 100%; this is not problematic and can be easily explained on the basis of the metric definition. This metric will most probably be used on a general analysis of the overall service and above the KSB properties.

Efficiency – the level of efficiency achieved in addressing the use case needs computed as % over the theoretical 100% full satisfaction of the workshop objectives. Also in this case it has to be possible to have results greater than 100% to accommodate the case where participants exceeded the defined maximal goals that the workshop planned to obtain.

- Example:
 - *threshold1: # of crossings (goal1): 15, reached: 1*
 - *threshold 2: # of crossings (goal2): 8, reached: 10*
 - *Thresholds are equally weighted (0.5)*
 - $0.5 \frac{goal1}{reached1} + 0.5 \frac{goal2}{reached2} = 90\% \text{ efficiency}$

Efficacy – the level of accuracy and effectiveness of the proposed solutions when compared with alternative solutions. This metric should be computed as the ratio between “% of success achieved with IoT” to “% of success achieved without IoT”.

- Example: defined goal for the service improvement, i.e.:
 - *# of toppling: 4, reached: 6*
 - $\frac{4}{6} = 66,67\% \text{ efficacy}$

Time spent in (design, implementation, testing, etc.) – objective measure of the time spent in the service as expected and as actually determined.

Interaction – this metric is composed of two measured elements: a measure of the overall interaction and a measure of the ratio between achieved interaction levels to the expected one. The level of interaction should be expressed qualitatively as: absent, very low, low, medium, high, very high. So far this metric is captured as the level of interaction over time and an average can then be calculated. Initially, the expected level is always “high” which equals the number of participants minus 1; a high interaction is expected, needed and aimed at with a Living Lab approach. This metric is captured manually by observation.

3.2.1.2 Adjustment of Living Lab iterations

Findings from the first Living Lab workshops and the evaluation of their results encourage an

	ELLIOT – Experiential Living Lab for the Internet Of Things	Project N.	258666
	D4.3.2 – Report on IOT Living Labs Continuous Exploration and Evaluation (interim)	Date	31.08.2012

approach in which parts of a Living Lab cycle (co-creation, exploration, experimentation) are carried out instead of a full cycle every time a Living Lab exercise is carried out. Instead, the order of workshops and Living Lab steps is based on the stage of development of the service. For example, a service which is still lacking important safety or security functions needs to be reviewed and adjusted before entering into live testing (experimentation). Similar cases are workshops with results not agreed upon by participants or obviously unusable results (e.g. no initial service solution). Those types of Living Lab workshops require a revision and refinement approach. Therefore an evaluation or a new co-creation workshop is likely to follow such a co-creation workshop rather than the exploration or even experimentation phase.

3.2.1.3 Questionnaire

To gain more knowledge about the Living Lab workshop participants, their expectations, knowledge about IoT and opinion about IoT, a questionnaire including some self-assessment questions is used. Because it is more related to data collection, this questionnaire is explained in the following Section 3.2.2.

3.2.2 Data Collection Changes

3.2.2.1 Refinement of KSB properties and Indicators

An important improvement relative to the time period from the setup of the Living Lab until the beginning of 2012 (PM18) is the reduction of the number of KSB properties used. Findings from the initial report and analysis (D4.3.1) have led to a better understanding of the usage of the model.

After having initially defined a set of KSB properties and related Indicators (KPIs), this set was revised and adjusted iteratively. Also the refinement and adjustment of the KSB property and KPI selection remained a constantly ongoing process. This refinement process was accompanied by discussions from project workshops and meetings during the first half of 2012 (PM18 onwards). This work led to a reduction in observed and investigated KSB properties and likewise to a revision of the indicators used to describe the KSB properties.

The refined list of KSB properties is presented in Section 3.1.2, Table 1. Initially, the list of KSB properties was more extensive. Major reasons for reduction were: first of all, the former KSB selection was based on a large amount of observation data which turned out to be not feasibly collectable. Furthermore, some simplifications were needed in order to better understand and work with the KSB model. Beyond this change, the relationship between Indicators and KSP

	ELLIOT – Experiential Living Lab for the Internet Of Things	Project N.	258666
	D4.3.2 – Report on IOT Living Labs Continuous Exploration and Evaluation (interim)	Date	31.08.2012

properties underwent a detailed analysis and investigation. A mayor proportion of the KSB properties might be defined in literature but cannot always be used as defined. The usage and the definition within the scope of the use case needed to be clarified.

The current selection of KSB properties is based on two aspects. First, to cover all perspectives of the model: K, S and B; second and also reflected in the selection, to work with properties which are clear and reasonable for this particular use case.

3.2.2.2 Less data gathered by human observation

While the metric selection was updated for better understanding of the service and its evaluation, a major change in data collection is the reduction of data gathered by human observation. Based on project workshops and meetings since PM18, the work focused on data gathering through IoT technologies included into the developed service. Therefore, data such as “noise level during workshop” was not gathered (see D4.3.1, Section 3.1.1, Table 6). However, the measures ‘average participation’ and ‘interaction’ were captured by human observation.

3.2.2.3 Adjusted questionnaires

During the improvement process the gathered amount of data regarding the participants was increased. This is an important step towards a better understanding of Living Lab workshop performances and results. Before, only general information of the participants, such as age, years of experience etc. was collected; in the more recent workshops reported on here, additional information was gathered. This information is gathered through anonymised questionnaires which furthermore provided an opportunity to identify potential improvements in the level of knowledge of the participants as well as changes in expectations regarding the workshops. To observe those changes, two steps were taken: first, suitable questionnaires were used in each workshop for briefing and debriefing; second, some participants attended additional iterations of the Living Lab experiments in order to observe developments over time.

3.2.2.4 More sensors and related data from the toolkit

In terms of sensors for data collection, the range of sensors used was refined and extended as listed in Table 2. Furthermore, the toolkit software, i.e. the related database, was adjusted to improve the representation of gathered data and the database structure. The actual process of collecting data is described in Section 3.4.1.

Table 2: Updated sensor list of logistics use case tool kit, indicating collected data

Category	Data Source	Data ID	Data measure
<i>IOT raw data</i>	Risk detection sensors	R1	Temperature
		R2	Humidity
		R3	Light level
		R4	Heart rate
		R5	Pressure (Air)
		R6	Pressure (Mechanic)
		R7	Distance
		R8	Rotation angle X-axis
		R20	Rotation angle Y-axis
		R21	Rotation angle Z-axis
		R9	Yaw rate X-axis
		R22	Yaw rate Y-axis
		R23	Yaw rate Z-axis
		R10	Vibration
		R11	RFID
		R12	Fingerprint
		R13	Compass
		R14	Lifter use
		R15	GPS
		R16	Video stream
		R17	(Microphone)
		R18	Altitude
		R19	Ubisense (Indoor-Localisation)
R20	Alcohol Gas		
R21	Methane Gas		
R22	Speed Meter		
R23	Galvanic Skin / Stress		

3.2.3 Data Analysis Changes

3.2.3.1 KSB properties and related KPIs

The reduction of KSB properties investigated for the logistics use case service is accompanied by a refinement of the indicator selection and calculation. Table 3 shows the KSB properties from Section 3.1.2, Table 1, and the related Indicators. The reduction of complexity mentioned above and a stronger focus on data collected by and directly related to IoT influence this development as well. Adjustments were also necessary in order to produce a set of properties which can be properly tested in the ELLIOT platform and can thus be better understood as a result. The processing and calculation of the properties will be explained in more detail in the data analysis section (see Section 3.5).

Table 3: KSB properties related to KPIs

KSB	KPI(s)
K4.1	Efficiency Efficacy
K2.3	<i>Heart beat</i> <i>Galvanic skin response</i>
S7.1	Time spent in service per shift # of logouts per shift complaint rate per shift (button clicks) Simplified: # log outs (before end of shift)
S7.2	<i>Likely bycombination of questionnaire and “dislike button” (see above, complaint rate)</i>
B1.2	# of risks (in t_n)
B2.1	<i>Not finally determined yet</i>
B4.6	Time spent in service (per shift) frequency of usage per day and per week expected achieved
B5.2	# of (all) sensors # of online accessible sensors
B5.3	# of devices (or platforms)

The following processes and/or calculations are used to elaborate the selected KSB properties from the collected data / from KPIs:

K4.1 Human Computer Interaction (HCI):

The assumption for this property is that the closer the actual numbers are in relation to (set) goals the better the IoT service is; in this context it is understood that it also indicates the level of Human-Computer Interaction (HCI), as the service communicated via a Graphical User Interface and internet based messaging. Therefore, this value is calculated by measured Efficiency and Efficacy, where (i) Efficiency represents the actual number of threshold crossings (not risks) and (ii) Efficacy represents the actual number of risks (those which took place). For both values goals are defined and set in relation to the actual values. These two measures are weighted equally to calculate the final value of the KSB property K4.1.

$$\frac{\frac{\text{goal (threshold)}}{(i) = \# \text{ threshold crossings}}}{\frac{\text{goal (risk)}}{(ii) = \# \text{ of risks (those which took place)}}} = \frac{\text{Efficiency}}{\text{Efficacy}}$$

S7.1 Attractiveness:

	t1	t2	weight			weighted
time spent	02:00	01:45	0,875	0,65		0,56875
log outs	1	1	0	0,15	=IF(x<0;0; x)	0
complaint rate	4	5	0,75	0,2		0,15

value of Attractiveness reached: 0,71875

To measure attractiveness, a comparison between t1 and t2 (e.g. sessions) in terms of time spent in the service, number of logouts and the complaint rate is carried out. In this example, the 'time spent in' is decreasing; as this is an important factor (weighted with 0.65) it has a big influence on the attractiveness of the service. The number of log outs is stable at 1, so a relative change of "0" is derived. If logouts increased from t1 to t2 this value would become '0', if it was to decrease the value would increase. This is because of the underlying assumption that an increased value of logouts during, for example, a working shift indicates problems with the software which lowers the attractiveness of the software (low value negatively influences attractiveness). If the number decreases, the value rises and thus has a positive influence on attractiveness. Finally, the complaint rate is measured, either by a button in the interface or with a questionnaire (not yet implemented). If this value increases, it has a negative influence of attractiveness and vice versa. In particular, a high relative change of the complaint rate has a greater effect on the weighted value.

A simplified approach to address the KSB Property S7.1 is the KPI "Number of Logouts before end of shift". A shift takes usually 8h, when the number of logouts exceeds 3 (two usual breaks and end of shift) the attractiveness decreases. This approach can be used when the approach described above is found to be too challenging to carry out.

B1.2 Performance Level:

In the relevant standards literature, the term 'performance level' is well-defined (cf. EN ISO 13849-1). Major measures for performance are 'Mean Time to dangerous Failure' (MTTF_d) and 'Diagnostic Coverage' (DC). These are measures used for machines being operated in an industrial environment. Due to the special circumstances in this case, where the service ("machine") is not yet finished / finally developed, a simplification for calculating the performance level was devised. Therefore, the Performance Level (PF) is calculated as the ratio between the 'number of risks in t0 minus the number of risks in t1' and 'the number of risks in t0 minus the set goal in terms of number of risks', or:

	ELLIOT – Experiential Living Lab for the Internet Of Things	Project N.	258666
	D4.3.2 – Report on IOT Living Labs Continuous Exploration and Evaluation (interim)	Date	31.08.2012

$$\frac{\# \text{ risks in } t_0 - \# \text{ risks in } t_1}{\# \text{ risks in } t_0 - \text{ goal } \#}$$

- # of risks in t0
- # of risks in t1
- Goal (maximum # of risks acceptable)

This represents a comparison of experiments in $t_{1...n}$ (and n+1) with IoT.

3.3 Participants

Table 4 shows the Living Lab workshops which have been carried out since the last report on IoT Living Labs Continuous Exploration and Evaluation, D4.3.1.³ The number of participants was usually 5 plus one moderator in each workshop. As described before, this number is mainly affected by the Serious Game which is used during the co-creation; the game supports five different players.

Table 4: ELLIOT logistics Living Lab workshops since D4.3.1

Location	Date	Living Lab Phase	Duration (h:m:s)	LL no. / Iteration
Bremen (BIBA)	25.06.2012	Co-Creation	03:05:00	I / 1 st
Bremen (BIBA)	27.06.2012	Exploration	03:05:00	I / 1 st
Bremen (BIBA)	05.07.2012	Co-Creation	02:40:00	II / 1 st
Bremen (BIBA)	06.07.2012	Exploration	02:15:00	II / 1 st
Bremen (BIBA)	11.07.2012	Co-Creation	02:45:00	III / 2 nd (I)

As previously, Living Lab workshops were mainly attended by students from the University of Bremen Industrial Engineering programme. However, professionals with initial work experience also participated in these groups. Assumptions about their experience were checked by using questionnaires, starting with the first workshop of those mentioned in Table 4.

Table 5: General information about participants of the logistics use case Living Lab I – co-creation

Workshop	General Information about Living Lab participants				
	Age	Sex	Profession	Expertise	Experience
Co-Creation (25.6.2012)	20	m	Student	Logistics	0
	25	F	Professional	Industrial Engineer	0,5
	20	F	Student	History	0
	28	m	Professional	Industrial Engineer	1,5
	27	m	Professional	Informatics	1

³ More workshops are already scheduled but cannot be taken into consideration for analysis before due date of this deliverable.

Table 5 and Table 6 provide general information about the set of participants for the first Living Lab (I) of this period. Participants marked in italics each participated in only one of the workshops. Thus the *20 year old female student* from the co-creation workshop did not participate in the exploration workshop. Therefore, the *22 year old male student* in the exploration workshop had to be familiarised with the results from the previous workshop by the moderator and the other participants.

Table 6: General information about participants of the logistics use case Living Lab I – exploration

Workshop	General Information about Living Lab participants				
Exploration (27.06.2012)	Age	Sex	Profession	Expertise	Experience
	20	m	Student	Logistics	0
	25	f	Professional	Industrial Engineer	0,5
	22	<i>m</i>	<i>Student</i>	<i>Production</i>	0
	28	m	Professional	Industrial Engineer	1,5
	27	m	Professional	Informatics	1

While the ratio of 3:2 (3 male : 2 female) for the co-creation was the same as for the analysed workshop in D4.3.1, that ratio changed to 4:1 in the exploration phase.

It has already been discussed that the number of participants attending a single workshop or a couple of workshops are not likely to reach a representative sample, neither for Bremen nor for Bremen University nor for the number of students in engineering at the University of Bremen. However, taking into account that the majority of engineering students are male, a ratio of 3:2 might provide a suitable sample. Nevertheless, even with the best possible mix based on the available players, a sample ratio 3:2 is able to provide a non-gendered result. This has to be taken into account when all workshops are analysed as some workshops group were composed of male participants only.

The following tables (Table 7 and Table 8) include the participant data from the other workshops as above, with the ratio of sexes added in column four.

Table 7: General information about participants of the logistics use case Living Labs I, II and III - co-creation

No.	Age	Gender	m : f	Field of Study	Years of Experience
II	29	M	5 : 0	Production	0
	22	M		Production	0
	22	M		Production	0
	25	M		System Engineering	1

III	23	M	2 : 2	Industrial Engineering	0
	20	M		Logistics	0
	28	M		Informatics	1
	25	F		Industrial Engineering	0,5
	21	F		History	0
IV	21	F	3 : 2	History	0
	29	M		Production	0
	28	M		Logistics	3
	25	F		Industrial Engineering	1
	22	M		Production	0

Workshop group II was a male-only group for the co-creation (Table 7) phase while in the exploration (Table 8), due to available participants, the male/female ratio changed back to 3:2. In workshop group III, only a co-creation phase was carried out. Furthermore, one questionnaire could not be recovered and therefore this data set is not complete for all participants. In the workshop the Serious Game was played with five players as required. In the last co-creation workshop, group IV, the ratio of sexes was again 3:2. However the average age (25.0) and the years of experience (0.8) were both higher than overall and than the workshop-level averages. This changed in the exploration workshop, where some participants were replaced and one additional participant attended.

Table 8: General information about participants of the logistics use case Living Labs I, II and III - exploration

No.	Age	Gender	m : f	Field of Study	Years of Experience
II	29	m	3 : 2	Production	0
	23	f		Industrial Engineering	0
	25	f		Industrial Engineering	0,5
	22	m		Production	0
	25	m		System Engineering	1
IV	25	F	3 : 3	Industrial Engineering	1
	22	M		Production	0
	21	F		History	0
	24	F		Industrial Engineering	1
	25	M		System Engineering	0
	29	M		Production	0

The larger the number of participants, the more representative of a larger population the results of an analysis are generally likely to be. In this particular case, the developed service is intended for

	ELLIOT – Experiential Living Lab for the Internet Of Things	Project N.	258666
	D4.3.2 – Report on IOT Living Labs Continuous Exploration and Evaluation (interim)	Date	31.08.2012

professionals in the field of intra-logistics (at least for the stage planned for this service). Thus the constellation and size of a representative group needs to be evaluated in the relevant context.

An experimentation workshop has not yet been performed and evaluated prior to the completion of this deliverable D4.3.2, hence no results from experimentation workshops are included in this deliverable.

3.4 Data Collection

3.4.1 Sensor Data

As part of the Living Lab experimentations and tool kit development the list of risk detection sensors (see D4.2.1, Section 7.2.2; and D4.3.1, Section 3.1.1, Table 3) is continuously being updated. Adjustments of the sensor list from D4.2.1 to D4.3.1 are explained in D4.3.1, Section 3.1.1. The updated list of sensors is shown in Section 3.2.2, Table 2 .

During the co-creation phase no sensor-specific data is collected, because the sensor tool kit in the logistics use case is not used in this phase and has not been introduced to the participants in this phase. Nevertheless, the utilisation of the tool kit for collecting data from the co-creation phase was discussed, as mentioned in D4.3.1. Findings from tests of the toolkit and its sensors suggested not using the toolkit for this purpose but once the participants started to explore the toolkit data is automatically logged and can be used for analysis. Yet, the Serious Game provides data which is related to sensor data. These are namely the kinds and numbers of sensors used in a service as well as the kinds and numbers of actuators used in a service. Even though these numbers cannot be used in the service’s KSB analysis, they are helpful for the toolkit and serious game evaluation.

During exploration and later mainly during experimentation, sensor data and derived risk logic data is gathered. This data provides the basis for the KPIs which are needed to describe the KSB properties listed in Table 1 and Table 3 (see above).

3.4.1.1 Sensor data

Values gathered from the sensor toolkit and aggregated values are stored in a PostgreSQL database. These values are written in user-definable intervals in steps of one millisecond.

The structure of the database is user-oriented. This means that all data is directly or indirectly related to a user of the toolkit. The ER-diagram in Figure 2 illustrates the database structure in its current state.

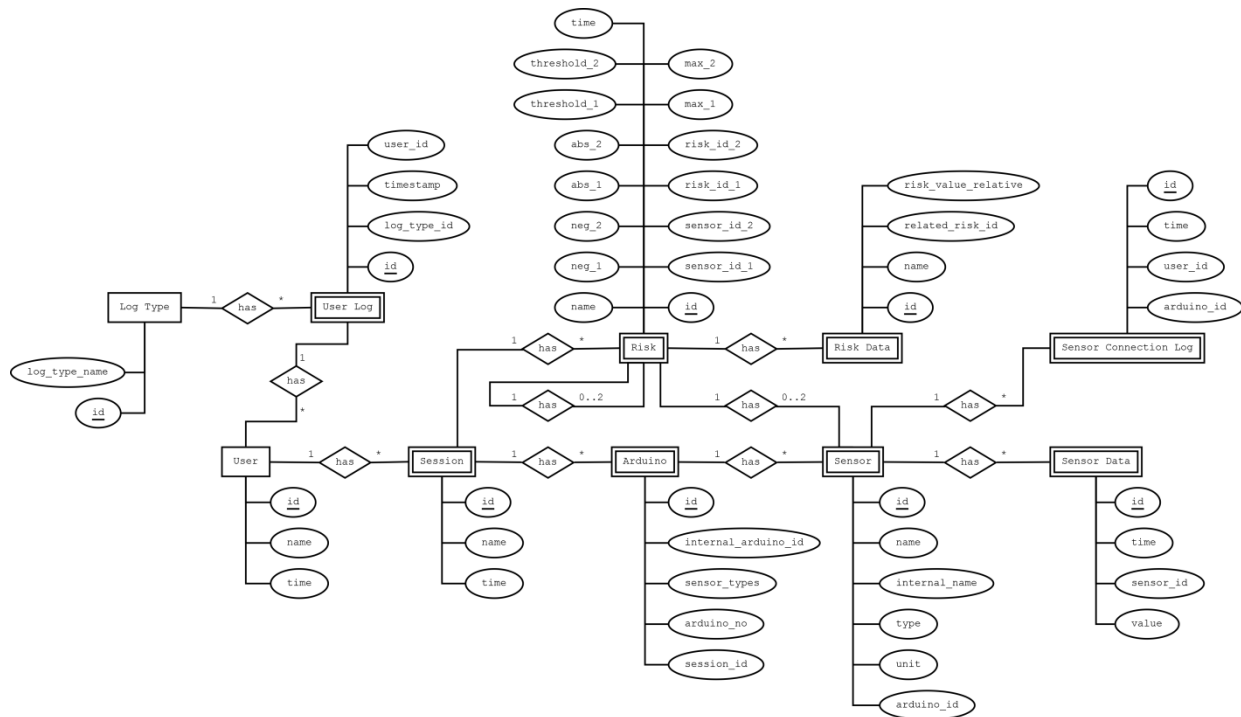

Figure 2: ER-diagram from logistics use case tool kit

Table 9: Example sensor data from logistics tool kit

Sensor name	Value	Unit	Date	Arduino ID	Session name
Accelerometer y-axis	-138.0	°	2012.Jul.06 - 11:32:13	508	elliott testsession
Pressure sensor	0.0	lbs	2012.Jul.06 - 11:32:13	508	elliott testsession
Accelerometer y-axis	-138.0	°	2012.Jul.06 - 11:32:14	508	elliott testsession
Pressure sensor	0.0	lbs	2012.Jul.06 - 11:32:14	508	elliott testsession
Pressure sensor	0.0	lbs	2012.Jul.06 - 11:32:15	508	elliott testsession
Accelerometer y-axis	-138.0	°	2012.Jul.06 - 11:32:15	508	elliott testsession

Table 9 shows a small sample of the recorded sensor data. Since the sensor tool kit has to handle many different types of sensors, the data is always saved with a reference to its connected microcontroller (entity *Arduino*) as well as the stored sensor metadata (entity *Sensor*).

3.4.1.2 Risk logic data

At this stage there are three types of qualified data. The first type is *Risk Data* which is calculated from values retrieved by the sensors. The second type is *User Log* which handles the user login

and logout actions. The last one is the *Sensor Connection Log* which provides information about the connected sensors, the time they were connected and who connected them.

All risk data derived from sensor data is stored with all corresponding values such as the resulting risk value, thresholds and limits which were defined inside the toolkit (See Table 10).

Table 10: Example Risk Data

Name	Time	Max 1	Threshold 1	Sensor name 1	Value 1	(other sensor and risk values)	Risk value
produkt 1 schwerpunkt	2012.Jul.06 - 12:17:01	30	7	Accelerometer x-axis	15°	...	59.1%
produkt 1 schwerpunkt	2012.Jul.06 - 12:17:02	30	7	Accelerometer x-axis	16°	...	63.6%
produkt 1 schwerpunkt	2012.Jul.06 - 12:17:03	30	7	Accelerometer x-axis	15°	...	55.2%
produkt 1 schwerpunkt	2012.Jul.06 - 12:17:04	30	7	Accelerometer x-axis	16°	...	63.7%
produkt 1 schwerpunkt	2012.Jul.06 - 12:17:05	30	7	Accelerometer x-axis	16°	...	63.6%
produkt 1 schwerpunkt	2012.Jul.06 - 12:17:06	30	7	Accelerometer x-axis	25°	...	90.0%
produkt 1 schwerpunkt	2012.Jul.06 - 12:17:08	30	7	Accelerometer x-axis	31°	...	100.0%
produkt 1 schwerpunkt	2012.Jul.06 - 12:17:09	30	7	Accelerometer x-axis	35°	...	100.0%

Logging of user actions is currently restricted to the time of a user login and logout but may be extended to other actions in the future.

In addition to the logged raw sensor data a separate log is maintained for every connected sensor; the collected data includes the user who connected the microcontroller with the sensors as well as a timestamp which indicates when the sensors were connected (See Table 11).

	ELLIOT – Experiential Living Lab for the Internet Of Things	Project N.	258666
	D4.3.2 – Report on IOT Living Labs Continuous Exploration and Evaluation (interim)	Date	31.08.2012

Table 11: Example sensor connection log

ID	Arduino ID	Time	User ID
233	687	2012.Jul.06 - 10:15:06	4
234	689	2012.Jul.06 - 10:18:56	4
235	691	2012.Jul.06 - 10:23:04	4

3.4.2 Observation and Survey Data

3.4.2.1 Observation of Living Lab workshops

The charts in Figure 3 were derived from analysis of the Living Lab workshop data (of Living Lab groups I, II and III). In the first co-creation session, observation was not carried out as would be needed for a consistent evaluation. For the Living Lab group III no exploration has been carried out, hence no observation data is available. The observation of the participation level was carried out by the living lab manager / workshop observer; the average participation was calculated in 15 minutes intervals. The gap in the Living Lab I exploration chart indicates a break; breaks were offered to participants in all workshops, however offers for breaks were rarely taken up. The break in Living Lab I Exploration was actually taken in a workshop which turned out to be the longest in duration (3 hours including the break).

LL I - Co-Creation

Participant observation could not be carried out properly.

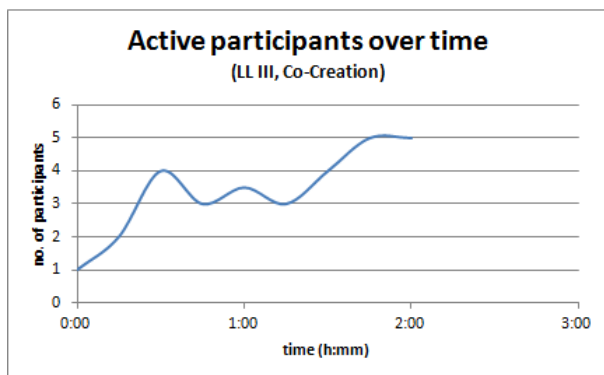
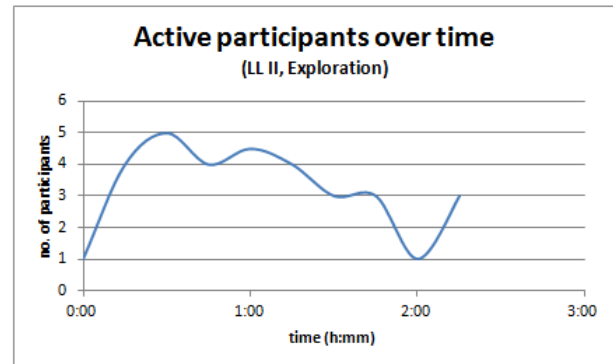
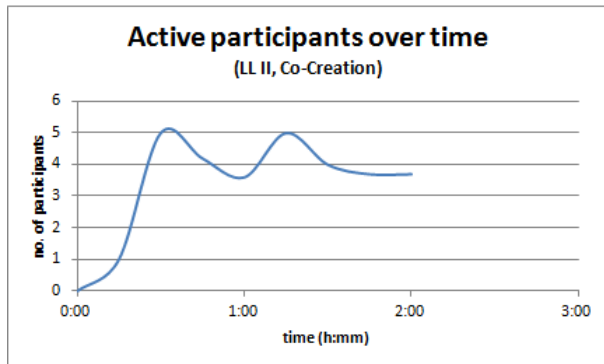
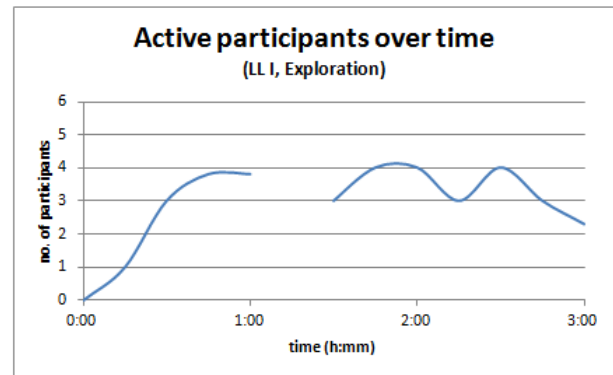

LL III - Exploration

No exploration carried out!

Figure 3: Level of participation in different Living Lab workshops

During the exploration workshops, the way participants used the provided toolkit including demonstration material was observed. Findings from this observation are relevant for the tool kit design, the way the tool kit is introduced, for which tasks it is used and to what extent it is used. A more details analysis of the tool kit as a tool for IoT-oriented user co-creation will be part of the upcoming deliverables D4.2.2 and D3.4.

	ELLIOT – Experiential Living Lab for the Internet Of Things	Project N.	258666
	D4.3.2 – Report on IOT Living Labs Continuous Exploration and Evaluation (interim)	Date	31.08.2012

3.4.2.2 Questionnaires from Co-Creation and Exploration Sessions

Questionnaires provide information about the participants, their expectations, and their pre-existing knowledge. Questions aim to understand what the participants expect to learn or do in the workshop (e.g. try out own ideas; gain new skills, take an active role), what their level of knowledge about IoT is (e.g. experience about applications and services) and their attitude regarding IoT (e.g. can IoT make life easier, can IoT generate logistic services). These insights are especially relevant for a better understanding of the individual Living Lab phases and workshops. The relevant questionnaire analysis will be discussed in the following section.

3.5 Data Analysis

3.5.1 Sensor Data Analysis

The data collected from sensors (see Section 3.4.1) is transmitted to the ELLIOT core platform via the ELLIOT middleware. There, based on the needs of the KPIs/Indicators, the data is further processed by data analysis components based on FocusLab services. In Section 3.2.3, KPIs are explained in relation to KSB properties.

Based on the expressed KPI requirements it is planned that a Web Service, e.g. FocusLab, will process data for KPIs as needed for further KSB property value calculation. The KPI level of detail and quality was discussed in project meetings and workshops. Based on these discussions, KPI needs for the logistics use case were refined. The following information is an example for data processing based on the expressed KPI requirements. The computation was carried out by FocusLab. The final process of data computation will be presented in the upcoming deliverable D4.3.3.

Sensor sessions (see Table 11):

- number of sensors connected per session
- number of microcontrollers connected per session
- duration of session

Table 12: Initially computed sensor data by FocusLab

id	name	user_id	date_time_min	date_time_max	Duration		arduino_ count	sensor_ count
					Day	Time		
484	test	1	27/06/2012 10:19	28/06/2012 10:53	1	00:34:00	2	4
487	stress test	3	27/06/2012 14:38	27/06/2012 14:41	0	00:02:56	1	1
488	LL I	3	27/06/2012 15:50	27/06/2012 16:20	0	00:30:02	1	1
499	screen	3	03/07/2012 16:52	03/07/2012 16:58	0	00:05:37	1	3
505	screenshot	3	03/07/2012 17:09	03/07/2012 17:12	0	00:02:27	2	4
507	pre-explo	3	06/07/2012 10:45	06/07/2012 10:48	0	00:02:52	1	2
508	elliott testsession	4	06/07/2012 10:57	06/07/2012 11:45	0	00:48:06	3	5
509	RFID_Accel	4	06/07/2012 11:46	06/07/2012 11:47	0	00:01:59	1	3
510	RFID_Acc	4	06/07/2012 11:48	06/07/2012 11:49	0	00:00:11	1	1
511	RFID_Acc	4	06/07/2012 11:50	06/07/2012 12:18	0	00:28:33	2	2

User Session (Table 13 is a sample representing the data of the table)

- Duration overall (sum): **1 hour 17 minutes and 53 seconds**
- During this time:
 - Number of Logins / user : **108 Logins for the same user**
 - Number of Logouts / user : **52 “manual” logouts & 56 without logouts**

The latter result is caused by logouts forced by the system.

Table 13: Data from FocusLab: user session (extract)

id	user_id	start	finish	Duration
1	1	02/07/2012 10:26:00	02/07/2012 10:26:13	0:00:13
3	1	02/07/2012 14:41:36		
4	1	02/07/2012 16:42:51		
5	1	02/07/2012 16:48:32	02/07/2012 16:51:05	0:02:33
7	1	02/07/2012 16:56:40	02/07/2012 16:58:43	0:02:03
9	1	16/07/2012 12:17:48	16/07/2012 12:19:19	0:01:31
...
140	1	24/07/2012 14:18:59	24/07/2012 14:19:08	0:00:09
142	1	24/07/2012 14:20:52		
143	1	24/07/2012 14:26:35	24/07/2012 14:26:51	0:00:16
145	1	24/07/2012 14:27:47	24/07/2012 14:28:00	0:00:13

147	1	24/07/2012 14:28:40	24/07/2012 14:28:53	0:00:13
149	1	24/07/2012 14:30:49		
150	1	25/07/2012 16:45:45	25/07/2012 16:46:06	0:00:21
152	1	25/07/2012 16:48:04	25/07/2012 16:48:11	0:00:07
154	1	25/07/2012 16:53:02		
155	1	25/07/2012 17:07:37	25/07/2012 17:07:56	0:00:19
157	1	25/07/2012 17:09:22		
158	1	25/07/2012 17:11:43		
159	1	25/07/2012 17:14:40	25/07/2012 17:15:17	0:00:37

With this data, the relevant Indicators for the KSB property *Attractiveness* are derived. To calculate the indicators and to derive this KSB property, the approach presented in Section 3.2.3 is used:

	t1	t2	weight		weighted	
time spent	02:00	01:45	0,875	0,65	0,56875	
log outs	1	1	0	0,15	0	=IF(x<0;0; x)
complaint rate	4	5	0,75	0,2	0,15	Button

value of *Attractiveness* reached: 0,71875

As the “complaint button” has not yet been implemented in the tool kit user interface, the complaint rate is always “0”. Nevertheless, the calculation includes this value. This implies the following two possibilities:

- (1) Only a value of 0.8 can be reached if all other indicators reach, individually, a value of 1.0.
- (2) In case an indicator exceeds 1.0 (100%), which might be possible (see Section 3.2.1), then the property could be in excess of a value of 0.8. Such results can be explained and are an example for the explanation given about the metrics in Section 3.2.1.

As an example, the calculation of the KSB property S7.2, ‘Attractiveness’, based on the limitation mentioned above (complaint button) and with the data provided by FocusLab is calculated for the sessions of 2.07.2012 (t1), 16.7.2012 (t2) and 17.6.2012 (t3). The sessions are interpreted as working shifts on separate days:

	t1	t2		weight		
time spent	06:32	05:03	0,773...9	0,65		0,5024721
log outs	3	3	0	0,15	0	0
complaint rate	0	0	0	0,2		0
<i>value of Attractiveness reached:</i>						0,5024721

button

	t2	t3		weight		
time spent	05:03	06:15	1,235...8	0,65		0,80301674
log outs	3	21	-6	0,15	0	0
complaint rate	0	0	0	0,2		0
<i>value of Attractiveness reached:</i>						0,80301674

button

Here, the development between the sessions can be seen very clearly. Even though the number of log-outs increased between session t2 and session t3, the Attractiveness level rose. This is because a negative development will be rated as a steady development due to the heavy impact caused by a negative KPI on the KSB property. However as the *time spent* in the service increases significantly from t2 to t3, the value for this KPI goes up from approx. 0.773 (t1/t2) to 1.235 (t2/t3). This Indicator is weighted heaviest with 0.65, thus the value rises accordingly.

Number of Risk and *number of threshold crossings* are not yet calculated by the platform or its related services. The required data processing was still being finalised when this deliverable was completed and will be reported on in deliverable D4.3.3.

In addition to the already mentioned KSB properties and related KPIs the KSB property *Availability* can be determined based on toolkit configuration (and, if relevant, based on design changes made by Living Lab workshops). This service is available on one device (Java app on Microsoft Windows PC). This is actually a very low number and would not be sufficient to achieve a KSB goal. However, it is expected that the service will be available on devices which can display web pages, thus the number of devices rises clearly (e.g. all OS and devices with HTML-web browser functionality).

B5.3	Availability	# of devices (or platforms)	1
------	--------------	-----------------------------	---

	ELLIOT – Experiential Living Lab for the Internet Of Things	Project N.	258666
	D4.3.2 – Report on IOT Living Labs Continuous Exploration and Evaluation (interim)	Date	31.08.2012

3.5.2 *Observation and Questionnaire Data Analysis*

3.5.2.1 Observation

The observation of the interaction and activity of the workshop participants shows differing results. While the Living Lab I exploration started smoothly and then maintained a constant level between 3 or 4 participants (high level) almost until the end, the exploration of Living Lab II started very actively and reached a very high (average 5 participants) activity level very quickly but steadily decreased afterwards down to a low level of activity of 1 after 2 hours.

Comparing the co-creation workshops of Living Lab II and III, they also follow different patterns. Co-creation II started a little smoother but then reached a very high level of participation quickly and maintained a high level until the end of the workshop. The co-creation workshop in Living Lab III started at a slightly higher level of activity, reached a high participation level which then remained between average and high (3 – 4) until it rose up to a very high level. This is a unique development at the end of this workshop in comparison to the other workshops held.

The expected level of activity was achieved in every workshop. The workshops show average to a high or very high activity level of participants which generally supports the Living Lab and workshop design and selected tools (relevant also for D4.2.2 and D3.4).

Furthermore, the curve shape of the Living Lab indicates that it may be preferable to introduce a forced break rather than an optional one (see Section 3.4.2) after the initial phase of exploration as almost all curves indicate a decrease of participation after 90 minutes (which is the duration of a university lecture session in Germany); except for Living Lab III, co-creation. The latter needs further investigation as this workshop reached a high activity level towards the end but was not leading to an exploration workshop. To analyse this, the game logs of the co-creation tool Serious Game can be analysed. The development of this curve could be caused by a lack of discussion at the beginning of the workshop which caused a lot of discussion at the end of the workshop and resulted in more significant disagreements between the participants regarding the workshop outcomes.

All results have to be compared with workshops carried out during the following month PM 25 to PM 30 in order to identify differences, patterns and developments in the Living Lab groups.

3.5.2.2 Tool kit

We designated as ‘demonstration artefacts’ those objects which were used to demonstrate the potential usage of sensors in an intra-logistics environment. During an initial workshop it was

	ELLIOT – Experiential Living Lab for the Internet Of Things	Project N.	258666
	D4.3.2 – Report on IOT Living Labs Continuous Exploration and Evaluation (interim)	Date	31.08.2012

observed that participants frequently used a small forklift model. Therefore, a bigger and more elaborate model was provided in later workshops. This model makes it possible to attach proper sensors and to move the model around in order to see how sensors and risk logics in the software (User Interface) react. This approach seems to prove helpful but needs careful attention at the same time. On the one hand, participants could better explain where to attach sensors and how they imagine risk situations with the forklift; on the other hand the model occasionally distracted participants during the workshop by moving their attention to attaching the sensors rather than dealing with the sensors and the risk logics. This aspect was identified during post-session discussions with participants.



Figure 4: The forklift 'demonstration artefact' to explore the scenario and the IoT toolkit

3.5.2.3 Questionnaires

In this section, the main results of the questionnaire analysis and interpretations of the collected data are presented. This does not include a detailed analysis of responses to individual questionnaire items. However, all questionnaires and questionnaire items are presented through an overview of questionnaire sections.

Answers in the questionnaires represent agreement or disagreement with a statement, each of which can be expressed at three different levels (high / medium / low), or a neutral 'neither agree or disagree' position. For reporting purposes, responses are referred to as numbers ranging from 3 (highly agreeing) to -3 (highly disagreeing) with '0' for 'no opinion'. The questionnaires used are provided in the appendix.

	ELLIOT – Experiential Living Lab for the Internet Of Things	Project N.	258666
	D4.3.2 – Report on IOT Living Labs Continuous Exploration and Evaluation (interim)	Date	31.08.2012

3.5.2.3.1 Co-Creation

Personal expectations for the workshop: The overall average of the responses by participants to this set of questionnaire items was moderately positive. Average responses to every questionnaire item ranged from between slightly and highly positive.

The first co-creation workshop was very positive in terms of participant responses. The majority of participants responded as being highly positive regarding their expectation of actively taking part in the workshop. Since some participants were not very familiar with the concept of IoT, they expected also to gain insights into IoT. The second co-creation workshop saw fluctuations in terms of responses. Looking at the responses, the participants were not expecting to gain new skills (question 3). This corresponds with participant’s expectation that they would not try out their own ideas (question 1). The third co-creation workshop had less of a spread of response averages with a majority of slightly negative and slightly positive answers. A commonality between all workshops was the participants’ expectation ‘to actively take part’ in the workshop (question 5).

Table 14: Average of responses to questionnaire items regarding expectations in three workshops

Question: <i>Workshop</i>	1 try out my own ideas.	2 get an insight into Internet of Things (IoT)	3 gain new skills	4 change something	5 take an active role in the events
<i>I</i>	2	1.8	1.6	1.4	2.4
<i>II</i>	-0.4	1.2	0.2	0.8	2.2
<i>III</i>	1	1.5	0	0.25	1.5

Experience with IoT: The overall average of participant responses was moderately positive. However, there was a distinct difference between the average responses to specific questions. Overall the responses frequently spread from highly positive to highly negative.

The first co-creation phase saw some participants with significant experience with the application and development of IOT services; there were also some with ‘no’ or ‘very little’ experience in this field (high variance in responses). The second co-creation phase saw slightly more ‘agreeing’ responses than the first phase. However, there were three participants who had ‘no’ or ‘very little’ experience with the development of IOT services, while two participants rated their experience as being considerable. This indicates a distinct gap between the participants in terms of experience.

	ELLIOT – Experiential Living Lab for the Internet Of Things	Project N.	258666
	D4.3.2 – Report on IOT Living Labs Continuous Exploration and Evaluation (interim)	Date	31.08.2012

The third co-creation phase showed better results with participants having ‘good knowledge’ about IoT services. The overall average of all the answers to individual questions was positive and higher than recorded for previous workshops. The spread of responses was narrower.

Table 15: Answers to questions regarding the experience with IoT (workshop group II)

Workshop	Group	Participant no.	Q1 I have experience with the application of IoT services.	Q2 I have experience with the development of IoT services.	Q3 I know and understand the technical background (sensors, actuators, logic) of an IoT service.
Co- Creation	II	1	-1	-3	3
		2	1	3	3
		3	2	-3	3
		4	3	2	-1
		5	-1	-2	1

Personal attitude regarding IoT: The overall response of the participants was highly positive. With a very low spread of data, all responses were positive to all the questionnaire items in this section.

The first co-creation workshop group responded positively to questionnaire items in this section in general. There was a notably high number of responses in agreement for the first questionnaire item of this section (‘IOT service can make day-to-day life easier’). In the second co-creation workshop participants were strongly agreeing with the statements. In comparison, less strong agreement was recorded regarding the statement that ‘the usage of logistics will make life easier for employees in their work’. In the third co-creation workshop participants were – on average – agreeing (highly but not very highly) with the statements regarding their personal attitude regarding IoT. At the same time, the averaged response was lower (but positive) compared to previous groups, yet constant in most of the questions.

Table 16: Answers to questions regarding "attitude regarding IoT" in co-creation phase (all groups; answers are indicated overall and in brackets per workshop)

	--- (-3)	-- (-2)	- (-1)	-/+ (0)	+ (1)	++ (2)	+++ (3)
IoT services can make day to day life easier.						10 (3/3/4)	4 (0/2/2)
IoT can generate services for logistics.					1 (1/0/0)	9 (2/3/4)	4 (2/2/0)
IoT services can increase the safety in logistics.					1 (0/0/1)	9 (4/2/3)	4 (1/3/0)
IoT services can offer relieve for employees in logistics.				1 (0/1/0)	6 (3/2/1)	5 (1/1/3)	2 (1/1/0)

Comparison with De-Briefing: Overall, the participants expressed their expectations as ‘high’ before the workshop, i.e. during the workshop briefing, and higher than the actual results achieved e.g. in trying out new ideas. On average their responses were still positive but overall results show that participant experiences do not match the expected level.

Personal expectations for the workshop: Some important insights can be derived from a more detailed review. In the first workshops group, participants stated that they did not learn new things. However, they expressed confidence that their participation would influence their decision-making. Comparing briefing and de-briefing workshops, the average response was lower and less positive. In the second co-creation workshop participants seemed relatively satisfied, however some slightly negative responses were also noted. Participants who were not confident about being able to “try out new ideas” during the briefing session responded positively after the workshop. Responses about their potential participation were also significantly more positive in the second workshop. This is supported by the curve shape seen in Figure 3, where for the second co-creation workshop a high level of participation was achieved. The third co-creation workshop shows average responses ranging from lower negative to lower positive. While participants had positive expectations about their participation in the briefing, the workshop results showed a tendency towards not having satisfied expectations. Similarly, their expectation of being able to learn new skills from the workshop was not satisfied.

	ELLIOT – Experiential Living Lab for the Internet Of Things	Project N.	258666
	D4.3.2 – Report on IOT Living Labs Continuous Exploration and Evaluation (interim)	Date	31.08.2012

Experience with IoT: The overall response of the participants after the workshop, even though it was slightly positive, was still lower than the expectation before the workshop. The majority of participants were not satisfied to the degree they had expected to be before the workshop. The first co-creation workshop had a significant number of slightly negative responses, and positive ones were just slightly positive. However, the participants’ interest in IOT applications was slightly increased after the workshop. In the second co-creation workshop, the overall average of the responses of the participants was positive; range of answers was from slightly negative to slightly positive in most of the cases. Responses show that the participants were to some extent satisfied with their expectation from the workshop. The debriefing phase of the third co-creation workshop showed a negative response compared to its briefing phase. It seemed that the participant’s assumptions and expectations were not satisfactorily fulfilled by the workshop. Further, the overall average was reduced and so were the variances of the answers.

Personal attitude regarding IoT: The overall average of participant responses was positive. Some co-creation workshops resulted in a lower spread of data with highly positive confidence in their answers.

The first workshop group saw an on average highly positive response from the participants with *no negative* responses and mostly with high and very high confidence shown in the responses. Noticeably, participants were highly satisfied with the workshop scenario of IoT generating service and increasing safety in the field of Logistics. Compared with the briefing phase of the workshop, the results show that most of their expectations were met. There was one interesting case of a participant, who had expressed very high expectations in the briefing and responded that their expectations had not been met to the degree reported by other participants. The second workshop group saw mixed responses from the participants. Some were very highly satisfied with the workshop, but some participants responded highly negative or only slightly positive. Compared with the briefing phase the results after the workshop showed negative responses. The average went down significantly. The third workshop group was comparatively similar to the first group. Most of the responses were higher and few were slightly more positive. It seems most of the participants strongly agreed with the statement that IoT can make day to day life easier. There was no significant difference between the response of the participants before the workshop (briefing) and after the workshop (debriefing); expectations were mostly met.

The opinion of the workshop participants: the debriefing questionnaire contains an additional block of questions and statements, the participants were asked to respond to regarding their opinion of the workshop: The overall response of the participants after the workshop was mildly

positive. In some sessions, participants answered very positively whereas in others the responses ranged from highly positive to highly negative. The first co-creation workshop showed positive responses from the participants. Most of them were highly confident with their responses, e.g. how interesting the workshop was. However, most of the participants were not completely sure whether the gathered results would support further development of IoT services in Logistics. The overall average of responses was higher than for the rest of the workshops. The second co-creation showed a mixed response from the participants. While most of the participants were answering positively or slightly positively, there was one participant whose answers were mostly negative. The third co-creation workshop completed with slightly more positive judgment responses by participants than the second one. Only one participant responded negatively to the questions. The overall average was high. Similar to other workshops, participants were highly satisfied with the user friendliness and ease of use of the provided features (Serious Game).

Table 17: Answers regarding "Opinion of the workshop" in co-creation phase (all groups; answers are indicated overall and in brackets per workshop)

	--- (-3)	-- (-2)	- (-1)	-/+ (0)	+ (1)	++ (2)	+++ (3)
The workshop was interesting.		1 (0/1/0)		3 (0/0/3)	6 (2/2/2)	5 (4/2/0)	
The functions of the software could be understood easily.			2 (1/0/1)		3 (0/2/1)	7 (3/3/1)	3 (1/0/2)
The process of the development was comprehensible	1 (0/1/0)		1 (0/0/1)		5 (2/2/1)	6 (2/2/2)	2 (1/0/1)
The gathered results will support further development of IoT services in logistics.			1 (0/1/0)	1 (0/0/1)	11 (5/4/2)	2 (0/0/2)	
I believe that the gathered results have the potential to lead to a relevant industrial service.		1 (0/1/0)		1 (0/1/0)	7 (2/3/2)	6 (3/0/3)	

	ELLIOT – Experiential Living Lab for the Internet Of Things	Project N.	258666
	D4.3.2 – Report on IOT Living Labs Continuous Exploration and Evaluation (interim)	Date	31.08.2012

Conclusion: The initial results from questionnaires show that generally, participants expect to learn and to bring in their own ideas, however in particular the workshop group II, showed a significantly different response pattern to the other two workshop groups. Furthermore, findings show that the expectations from co-creation workshops (briefing) were not fully met (debriefing). However, the second workshop group was more strongly convinced of their ability to actively take part at the end of the workshop which was also supported by the activity analysis (cf. curves Figure 3). Prior experience and knowledge about IoT was rather low and increased only very slightly by the end of the workshop. Furthermore, the expectations regarding IoT services were positive.

Results from questionnaires and participation analysis show that expectations regarding the co-Creation workshop have to be managed carefully; changes to the workshop preparation and design should be considered. The participation analysis showed – in general – a good level of participation. Suitable management of expectations could help to improve the learning and participation experience, which are correlating aspects especially when looking at the supporting tool Serious Game (learning through experience). Here, additional questions from the debriefing show a positive result: The software was considered to be user-friendly.

3.5.2.3.2 *Exploration*

Personal expectations for the workshop: Overall average responses of the Exploration workshop were mildly positive with mostly highly positive responses.

The first exploration workshop saw comparatively positive responses from the participants. Diverging from this general observation, responses to the fourth question regarding the expectation of the participants to “change something” was lower. The second exploration workshop saw more negative responses than the previous workshop. The overall average was lower. It seemed participants were quite eager to actively participate in co-creation. Moreover, more than half of the participants were seen to expect to “change something” while others responded negatively about this expectation. The third exploration workshop showed more negative results. The response pattern with just above zero might indicate that participants were unsure about their expectations but they expected to actively participate in the co-creation.

Table 18: Average of responses to questionnaire items regarding “expectations for the workshop” in exploration phase (all groups; answers are indicated overall and in brackets per workshop.)

	--- (-3)	-- (-2)	- (-1)	-/+ (0)	+ (1)	++ (2)	+++ (3)
try out my own ideas.			1 (1/0/0)	2 (0/0/2)	4 (0/1/3)	8 (3/4/1)	1 (1/0/0)
get an insight into Internet of Things (IoT).			1 (0/0/1)	4 (0/1/3)	4 (1/2/1)	6 (3/2/1)	1 (1/0/0)
gain new skills.			1 (0/0/1)	2 (0/1/1)	6 (2/2/2)	6 (3/1/2)	1 (0/1/0)
change something			3 (2/1/0)	5 (0/1/4)	4 (2/1/1)	3 (1/1/1)	1 (0/1/0)
take an active role in the events.					4 (0/1/3)	8 (5/1/2)	4 (0/3/1)

Experience with IoT: Overall, the average response of the participants were positive, but it was just above zero range. The deviations of the responses were higher, showing there were some participants who already had some knowledge about IoT as well as some who had little or no knowledge.

The first workshop showed a distinct spread of data; most of the participants were very unsure or had little knowledge of the topic. The second workshop was slightly better in terms of average responses, however the spread of responses was significant. Most of the participants had sound experience and knowledge about IoT, still there was one participant who was totally new to the topic. The third workshop seemed to have an equal number of participants with a sound understanding of IoT and those without any knowledge about IoT.

Table 19: Average of responses to questionnaire items regarding “Experience with IoT” in exploration phase (all groups; answers are indicated overall and in brackets per workshop.)

	--- (-3)	-- (-2)	- (-1)	-/+ (0)	+ (1)	++ (2)	+++ (3)
I have experience with the application of IoT services.	1 (0/1/0)	3 (1/0/2)	1 (1/0/0)	1 (0/0/1)	5 (2/1/2)	4 (0/3/1)	1 (1/0/0)
I have experience with the development of IoT services.	1 (0/1/0)	3 (1/0/2)	1 (0/0/1)	1 (0/1/0)	4 (2/1/1)	4 (1/1/2)	2 (1/1/0)

I know and understand the technical background (sensors, actuators, logic) of an IoT service.	1 (0/1/0)	1 (1/0/0)	1 (1/0/0)	1 (0/0/1)	3 (1/0/2)	5 (1/2/2)	4 (1/2/1)
---	-----------	-----------	-----------	-----------	-----------	-----------	-----------

Personal attitude regarding IoT: The overall averaged response of the participants was highly positive. There was very less variation in responses, with most of the participants highly confident about their answer.

None of the responses were found to be consistently negative throughout the workshops. Participants were found to be a little bit less confident on IoT services bringing relief for employees in the logistics sector. The second exploration workshop showed data with participants with higher confidence in their expectations.

Table 20: Average of responses to questionnaire items regarding “Personal attitude regarding IoT” in exploration phase (all groups; answers are indicated overall and in brackets per workshop.)

	--- (-3)	-- (-2)	- (-1)	-/+ (0)	+ (1)	++ (2)	+++ (3)
IoT services can make day to day life easier.					2 (0/1/1)	10 (3/4/3)	2 (2/0/0)
IoT can generate services for logistics.					3 (2/0/1)	6 (2/2/2)	5 (1/3/1)
IoT services can increase the safety in logistics.					2 (1/0/1)	8 (3/3/2)	4 (1/2/1)
IoT services can offer relieve for employees in logistics.					4 (1/2/1)	7 (3/1/3)	3 (1/2/0)

Comparison with Debriefing:

Personal expectations for the workshop: The overall response average of the participants was slightly positive. Throughout the workshop, participants had mixed responses but very few participants gave highly positive responses. Compared to the briefing phase of the workshop, the

	ELLIOT – Experiential Living Lab for the Internet Of Things	Project N.	258666
	D4.3.2 – Report on IOT Living Labs Continuous Exploration and Evaluation (interim)	Date	31.08.2012

responses were lower than before.

The first exploration workshop was marginally positive in response. In the debriefing, three participants responded similarly to what they had responded during the briefing; two responded reporting negative results relative to their expectations. Most of the participants felt they were not able to “change anything” during co-creation.

The second exploration workshop's debriefing phase showed better results than the previous workshop group. Answers were ranging from slightly negative to highly positive. However, similar to the previous workshop, participants felt they could not “change something”, but they felt they were able to “try out their own ideas”. Overall the responses after the workshop were similar to the expectation of the participants before the workshop. The third exploration workshop did not reach expectation levels. Even though participants had given responses of very low expectations before the workshop, their answers afterwards were even lower. Most of the responses were negative but regarding the participation during the workshop, the responses show agreement.

Experience with IoT: The overall response of the participants in the exploration workshop was positive. However, for instance, in some workshops participants were seen to be highly satisfied in comparison with what they had expected during the briefing phase, while in one workshop the opposite was the case. The average reported experience with IoT was significantly higher in satisfaction after the workshops than that reported in the workshop briefings.

The first exploration debriefing shows an overall positive response. A few participants responded negatively, but most of them were slightly positive or even highly positive. Compared to the briefing phase, participants who had not expected to gain much insight about IoT were found afterwards to have gained sound knowledge. Regarding the “interest in IoT applications”, average responses had risen from slightly positive to positive after the workshop. The second workshop debriefing was also positive, with most of the answers showing that expectations were met and with only positive responses. However, one participant who had highly negative expectation from the workshop responded with ‘slightly positive’ and ‘positive’ after the workshop. Participants in the third exploration workshop reported very little experience prior to the workshop (briefing), which turned into slightly more experience after the workshop (debriefing). However some of the participants who had expected gaining “knowledge about developing IOT services” reported that their expectations had not been fulfilled.

Personal attitude regarding IoT: Overall, even though the average of responses regarding the personal attitude regarding IoT of all workshops was positive, it was lower in the debriefing

phase than in the briefing phase. The overall satisfaction of the participants after the workshop seemed to be lower in most of the cases; although the response to all the statements was positive.

There was no significant difference between the workshops. All of them shared similar responses from the participants. The first workshop had the lowest spread of data compared with the other workshops. However, some decrease in the responses was seen regarding “how IoT can make day-to-day life easier”. Participants were seen to be slightly less confident about this topic compared with what they expected before the workshop. The second and third exploration workshop debriefings were similar to the briefing ones. There was no notable difference.

Opinion about the workshop: The overall response of the participants was positive with most of the answers ranging between positive and highly positive. There was not much variation in the answers. Few negative responses were seen and the overall satisfaction was high.

The first exploration workshop saw comparatively lower average responses among all other workshops but was still positive on average. Participants felt the gathered results will support further development of IoT service in logistics and led to a relevant industrial service. In the second exploration workshop participants seemed satisfied with the workshop experience. They felt the toolkit was easily understandable. An interesting pattern was found in responses to the fifth question. Half of the participants responded highly positive whereas two of the participants responded neutrally. Participants in the third exploration workshop were highly satisfied with the experience (e.g. the ease of using the tool kit). Most of them felt that the process of development was comprehensible.

Table 21: Answers regarding " Opinion about the workshop" in exploration phase (all groups; answers are indicated overall and in brackets per workshop)

	--- (-3)	-- (-2)	- (-1)	-/+ (0)	+ (1)	++ (2)	+++ (3)
The workshop was interesting.				1 (0/0/1)	6 (3/2/1)	4 (1/2/1)	3 (0/1/2)
The functions of the software could be understood easily.			1 (1/0/0)	2 (0/1/1)	2 (1/0/1)	6 (1/3/2)	2 (0/1/1)
The process of the development was comprehensible		1 (1/0/0)		1 (0/1/0)	3 (1/2/0)	8 (2/2/4)	1 (0/0/1)

The gathered results will support further development of IoT services in logistics.				2 (0/1/1)	8 (2/4/2)	3 (2/0/1)	1 (0/0/1)
I believe that the gathered results have the potential to lead to a relevant industrial service.				2 (0/2/0)	3 (2/0/1)	8 (2/3/3)	1 (0/0/1)

Conclusion: The exploration workshops are showing a gap between participants’ expectations articulated and the results achieved by the end of the workshop. This means that participants do not realise the outcome that they expect from participating in the exploration workshop. However, in comparison with results from the co-creation workshops, the exploration workshops show better results than the co-creation workshops. As for the co-creation workshops, changes in workshop preparation and design should be considered to improve the learning and participation experience. However, interest and experience regarding especially the IoT experience was positive and slightly increasing. The toolkit was also rated positively. This, on the other hand, supports the design of the exploration workshop and the use of the Arduino Toolkit.

In this context it should be taken into account that the participants were all students and during discussions their intrinsic motivation to learn new things about “what is going on in this Living Lab” was obvious. Thus their expectations might be higher than the expectations of a ‘real workforce’.

3.5.3 Data-KSB Mapping

Elaborated values from the properties mentioned above can either be represented in percentages or in a binary manner: achieved versus not achieved. The latter approach will be used initially; even though this is a simple approach to working with the KSB properties it is believed that it helps to better understand relationships. In future model iterations, a more granular approach in percentages will likely be applied. At least with the short list of properties this can easily be carried out as most of them are already calculated on a percentage level. The planned limits to define achieved versus not achieved goals are presented in the following Table 22:

Table 22: KSB and corresponding thresholds "achieved vs. not achieved property"

KSB	KSB name	Threshold(s)
K4.1	Human computer interaction	> 80% (below: not achieved)
<i>K2.3</i>	<i>Attunement of affordances</i>	> 70 bpm and <100 bpm
S7.1	Attractiveness	> 80% (below: not achieved)
<i>S7.2</i>	<i>Appealingness</i>	<i>Under development</i>
<i>B1.2</i>	<i>Performance Level</i>	> 90% (below: not achieved)
<i>B2.1</i>	<i>Reliability</i>	<i>Under development</i>
B4.6	Loyalty	> 60% (below: not achieved)
<i>B5.2</i>	<i>Accessibility</i>	ratio "all sensors to online accessible sensors" is relevant: > 50%: achieved (below: not achieved)
<i>B5.3</i>	<i>Availability</i>	> 3: achieved (below: not achieved)

Finally, with KSB properties all defined and calculated as described, it is necessary to compute them into one final KSB perspective. Therefore, for each KSB perspective the selected properties have to be weighted. Initially, only one property per perspective is selected. Thus, no weighting needs to be performed at this point in time.

Based on the presented set of KSBs, the following weights (Table 23) are proposed for the overall KSB measurement of the services elaborated by the ELLIOT logistics Living Lab when all of the defined KSB properties will be used:

Table 23: Proposed weights for the KSB measurement

KSB	KSB name	weight
K4.1	Human computer interaction	0.6
<i>K2.3</i>	<i>Attunement of affordances</i>	<i>0.4</i>
S7.1	Attractiveness	0.5
<i>S7.2</i>	<i>Appealingness</i>	<i>0.5</i>
B1.2	Performance Level	0.3
<i>B2.1</i>	<i>Reliability</i>	<i>0.1</i>

	ELLIOT – Experiential Living Lab for the Internet Of Things	Project N.	258666
	D4.3.2 – Report on IOT Living Labs Continuous Exploration and Evaluation (interim)	Date	31.08.2012

B4.6	Loyalty	0.2
B5.2	Accessibility	0.2
B5.3	Availability	0.2

3.6 Results and Inferences

3.6.1 Experiment Outcomes

3.6.1.1 Attractiveness

Overall, the Living Lab and its toolkit were rated positively by workshop participants and resulted in much interest in discussions with experts. However, the acceptance of such services by the workforce / forklift drivers was mentioned as a critical point to observe. It can be assumed that the service solution design will have a high impact on this aspect.

3.6.1.2 Benefits

On a more granular level, the workshop results were positive, some new ideas were developed and new aspects were found by the participants. Participants also provided valuable insights into the Living Lab which increased the value of results further. In this context, applied changes made to workshop and Living Lab design could be evaluated and adjusted, including the KSB and KPI refinement which was discussed throughout this deliverable (see Section 3.6.2).

3.6.1.3 Strengths

The Toolkit is seen as a strong point in the Logistics Living Lab, including its recent extension by demonstration artefacts. In the previous deliverable D4.3.1, an extension of the toolkit by physical artefacts had been suggested. This idea was put into practice by placing a model of a forklift (1:6) and corresponding pallets and packages into the Living Lab. This model is mainly used throughout the Exploration phase. Participants use it to explain risk situations and to test sensors. These demonstration artefacts improve the Exploration workshops and help the participants to better understand circumstances and dependencies as well as to reach a common understanding of the toolkit (see also *opportunities* below).

3.6.1.4 Weaknesses

Even though important aspects have already been considered, additional work has to be carried

	ELLIOT – Experiential Living Lab for the Internet Of Things	Project N.	258666
	D4.3.2 – Report on IOT Living Labs Continuous Exploration and Evaluation (interim)	Date	31.08.2012

out in the final period of the project. Data processing of presented data is not yet fully integrated into the ELLIOT platform. However, final steps for completing this implementation were ongoing in parallel with the preparation of this deliverable, therefore experimentation including data processing via the platform will be reported on in the upcoming deliverable D4.3.3.

Moreover, the current development status of individual services (from Living Lab groups) and the integrated solution cannot yet be seen as a “final product” of the ELLIOT project. The case specific characteristics imply that a final solution is not available from the start. This means that more time is necessary for the ongoing development of an integrated solution. The results achieved so far will shortly be combined and set up in a service. Despite this, this service can hardly be seen as finalized as more testing and probably re-design by Living Lab groups is necessary.

3.6.1.5 Opportunities

The results of the questionnaire data analysis indicate some challenges lie ahead regarding the management of expectations taking into consideration the realistically attainable learning experience during these co-creation and exploration workshops. However, in particular the exploration workshop seems to result in the workshop participants gaining knowledge about and understanding IoT technologies and their potential. Thus, the co-creation experience in particular should be focused on when redesigning the workshops; expectations could be more closely connected with the following Living Lab workshops (e.g. exploration) to create more appeal and prevent a loss of motivation during co-creation. The serious game could be used to support this strategy, for instance with extended content aiming at IoT exploration and activities.

Overall, experiences and analysis of the Living Lab workshops, groups and results indicate potential for IoT co-creation on very specific fields of application. This includes working together with highly trained personnel in the field of sensible goods transportation. Showing these experts the functionalities and related potential of IoT technology could increase their involvement in the development of new products and services. Furthermore, the analysis of the running service via the KSB model application may lead to improved understanding of the user experience.

The observations made on the toolkit use, including the added artefacts, provides evidence that this approach might be helpful to support IoT-oriented user co-creation. Observations have led to the conclusion that combining the toolkit with artefacts helps in discussing and understanding challenges of the specific use cases and risk scenarios. However, attention that would ideally be

	ELLIOT – Experiential Living Lab for the Internet Of Things	Project N.	258666
	D4.3.2 – Report on IOT Living Labs Continuous Exploration and Evaluation (interim)	Date	31.08.2012

focused on the IoT usage may be diverted to the specifics of the toolkit and its artefacts. It was observed that the toolkit artefacts can distract the participants, for example, when participants start to discuss where and how to assemble the sensors. Such discussions can easily move away from the initial goal to discuss the sensor and actuator setup of the service solution. This challenge needs further attention to select an accordingly adjusted workshop design.

3.6.1.6 Threats

Results and discussions from the Living Lab workshops pointed out one important aspect relevant for the utilisation of an IoT toolkit for the development of (IoT) services. The prototypic model of the toolkit is faced with regular technical failures. Such failures cause disappointment and can lead to lack of interest in workshops/cases by participants. Using a system still in a development stage would quite likely lead to disappointment and reduced adoption rates if it was used for a service development in an industrial environment. Additionally, when developing services with non-experts / end-users, these groups of users will have to deal with “daily business” as well as with participating in workshops. Technical failures causing delays would then be likely to lead to dwindling acceptance for user co-creation.

3.6.2 KSB Analysis

In the previous deliverable D4.3.1, the definition and application (instantiation) of KSB properties and related KPIs was extensively elaborated on. Throughout the past project months, during discussions with WP4 partners, the instantiation of the KSB model for the logistics use case was adjusted. Therefore, the number of initially investigated KSB properties was heavily reduced and accordingly the number of indicators (and later KPIs) was also reduced. This was a necessary step in order to make applying the model to the use case easier. Furthermore, the modelling of the selected KSB properties is considered positive and “applicable” to the logistics use case by the Living Lab. It is expected that the integration of the presented KSB property selection into the ELLIOT core platform will lead to the expected outcome in terms of a measurement regarding the Knowledge, Social and Business aspects of the developed IoT service. However, such measurement will be an early step to understanding complex relationships underlying successful solution development by user co-creation. Adjustments and more investigation seem to be necessary in order to reach a convenient and more generic understanding of user co-created services. Important aspects of these improvements have been discussed throughout this Chapter 3.

4 City of the Future Use Case [HSR]

4.1 Experiment Overview

4.1.1 Experiment Description

City of the Future Living Lab is involved in the ELLIOT Project using four different scenarios. Each scenario has a unique set of goals in terms of user experience objectives expressed also in terms of Knowledge-Social-Business expected benefits, as illustrated in the figure below.

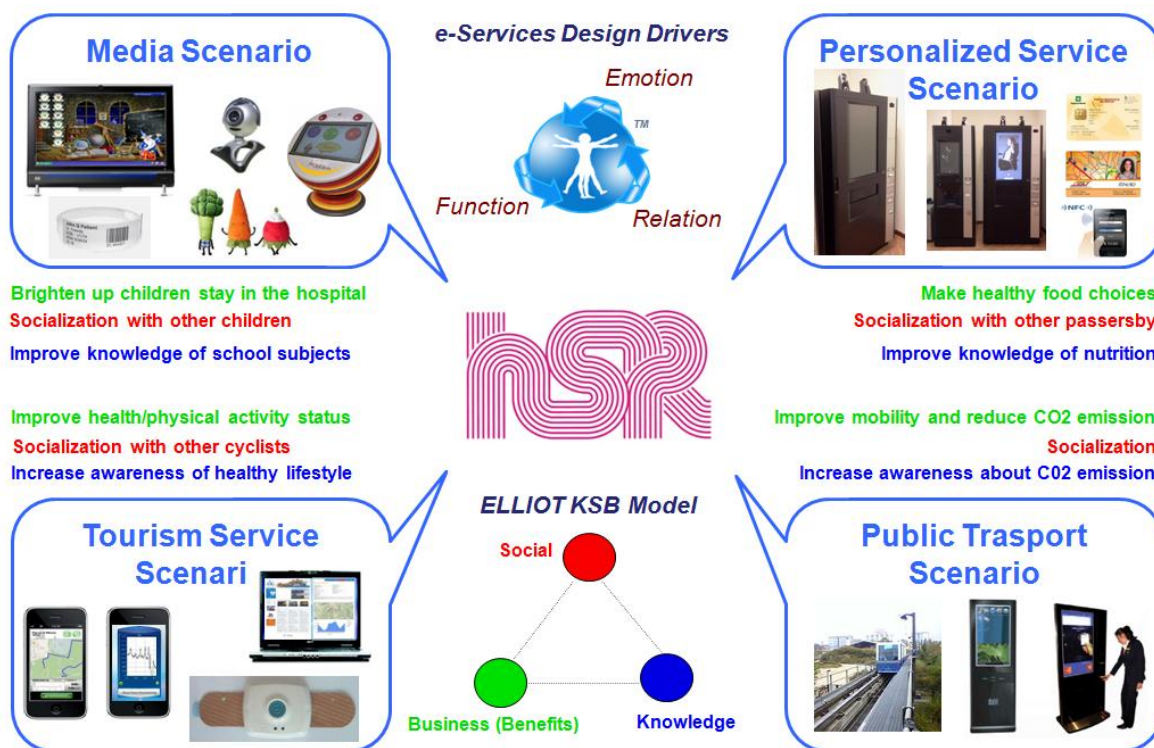



Figure 5: City of the Future use case scenarios and their respective ELLIOT goals in terms of the KSB model

The “Media Scenario” is the first scenario to have recently undergone crucial experimentation (see D4.3.1), with the installation of an interactive totem in OSR’s pediatric department. Hospitalised children (about 40 of them per week and who change week to week) had free access to the device which was extremely useful in uncovering potentialities and limitations both of the ELLIOT project as well as the of the KSB Model. The experience was also essential in

	ELLIOT – Experiential Living Lab for the Internet Of Things	Project N.	258666
	D4.3.2 – Report on IOT Living Labs Continuous Exploration and Evaluation (interim)	Date	31.08.2012

redirecting the management of succeeding Living Lab phases concerning our other scenarios.



Figure 6: Freeze frames of a video showing the Experimentation phase of our Media Scenario

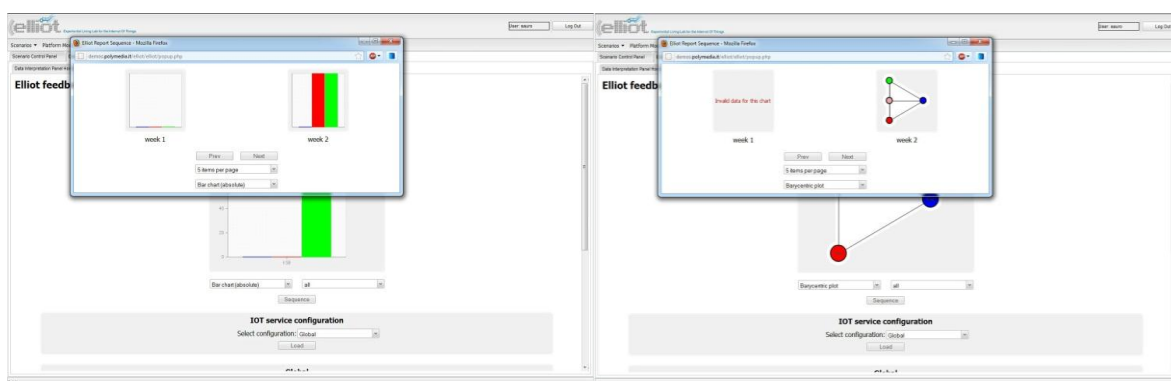

Figure 7: Output of the Elliot Platform concerning our Media Scenario generated by the first interim platform.

In subsections 4.4 and 4.5 the focus is mainly on “Personalised Services” and “Public Transport” scenarios because they have been deployed in the Living Lab via the innovative vending machines. Efforts in the second year of the project have been concentrated on these activities, and in this deliverable particular attention will be drawn to the results of such activities.

The Living Lab is up and running in all four phases of the process. The co-creation phase has already come to its conclusion and was presented in deliverable D4.3.1 as well as in the paper presented in the ImViReLL’12 Conference entitled “A Living Lab for Internet of Things Vending Machines” [1]. The exploration, implementation, and setup periods (which lasted about 3 days) have also been concluded, whilst the evaluation phase has begun but requires further activities in order for it to be implemented correctly, especially concerning integration with the Elliot platform.

	ELLIOT – Experiential Living Lab for the Internet Of Things	Project N.	258666
	D4.3.2 – Report on IOT Living Labs Continuous Exploration and Evaluation (interim)	Date	31.08.2012



Figure 8: Freeze frames of a video showing the way in which the Temporary Store was assembled

The “Personalised Services” and “Public Transport” scenarios, now renamed “Benessere in Movimento” project (“Well-Being on the Go”) have recently moved into the Experimentation phase of its Living Lab cycle, meaning that a space has been designed and deployed where two snack vending machine and one coffee vending machine have been exposed to the public.

	ELLIOT – Experiential Living Lab for the Internet Of Things	Project N.	258666
	D4.3.2 – Report on IOT Living Labs Continuous Exploration and Evaluation (interim)	Date	31.08.2012



Figure 9: A photograph of the Temporary Store

The Tourism Service Scenario is about to see its Exploration phase come to a conclusion. Doctors, technicians, IT engineers, bio-engineers, students, patients and sports fanatics were all involved in the elicitation and validation of the requirements identification, engineering and testing of all the devices and applications related to the IoT System involved in the project.



Figure 10: Freeze frames of a video showing the way in which the smart patch, smartphone application and web service are tested in our Lab

At this point we will be able to begin the Experimentation phase with about 30 users and then further on evaluate the system through the use of the ELLIOT Platform.

4.1.2 KSB Instantiation

A subset of KSB instantiation values for the testing of each scenario of the City of the Future use case has been identified. They have been listed in an arbitrary and random manner, and chosen for their similarity (even if only approximate) to what has been identified as relevant in the analysis of the user experience and in relation to the KSB model.

Media Scenario

K	K4.3	Cognitive artefacts	Cognitive processes may be distributed in the sense that the operation of the cognitive system involves coordination between internal and external (material or environmental) structure.
S	S9.1	Socialisation	Reflect a set of agreed social norms.
B	B3.2	Ease of use	The level of usability.

Personalised Service Scenario

K	K4.1	Human computer interaction	How to design human-machine interfaces and cognitive artefacts so that human performance is sustained in work environments where information may be unreliable, events may be difficult to predict, multiple simultaneous goals may be in conflict, and performance may be time constrained.
S	S7.1	Attractiveness	Level of enthusiasm or boredom
B	B4.1	Usefulness	In economics, utility is a measure of relative satisfaction. It refers to the total satisfaction received by a consumer from consuming goods or a service. Utility is often modelled to be affected by consumption of various goods and services, possession of wealth and spending of leisure time.

Tourism Scenario

K	K5.1	Self-examination	Introspection on self actions via experiences (thoughts).
S	S1.1	Social Networking	Ability to establish positive social (interpersonal) ties as information carrying connections among people (social networking).
B	B1.1	New functionalities (IoT)	The degree of creativity expressed by newly designed product or service artefacts based on the use of IoT.

Public Transport Scenario

K	K2.2	Sensing affordances	Properties of the environment, specified in the information array (flow field) of the individual, that present possibilities for action and are available for an agent to perceive directly and act upon.
S	S7.2	Appealingness	Level of curiosity and desire or disappointment and frustration
B	B1.4	Connectivity (IoT)	The degree of connectivity provided by the use of IOT

	ELLIOT – Experiential Living Lab for the Internet Of Things	Project N.	258666
	D4.3.2 – Report on IOT Living Labs Continuous Exploration and Evaluation (interim)	Date	31.08.2012

4.1.3 Connection to ELLIOT Platform

In order to collect data coming from different IoT systems involved in the City of the Future scenarios, a server has been installed within the eServices for Life and Health research unit able to collect data, direct it to a repository and allow the ELLIOT/Hydra Middleware client to send it via push or pull to the ELLIOT Core Platform. Data will then be elaborated via FocusLab services and fed back to the Living Lab Manager using a web tool.

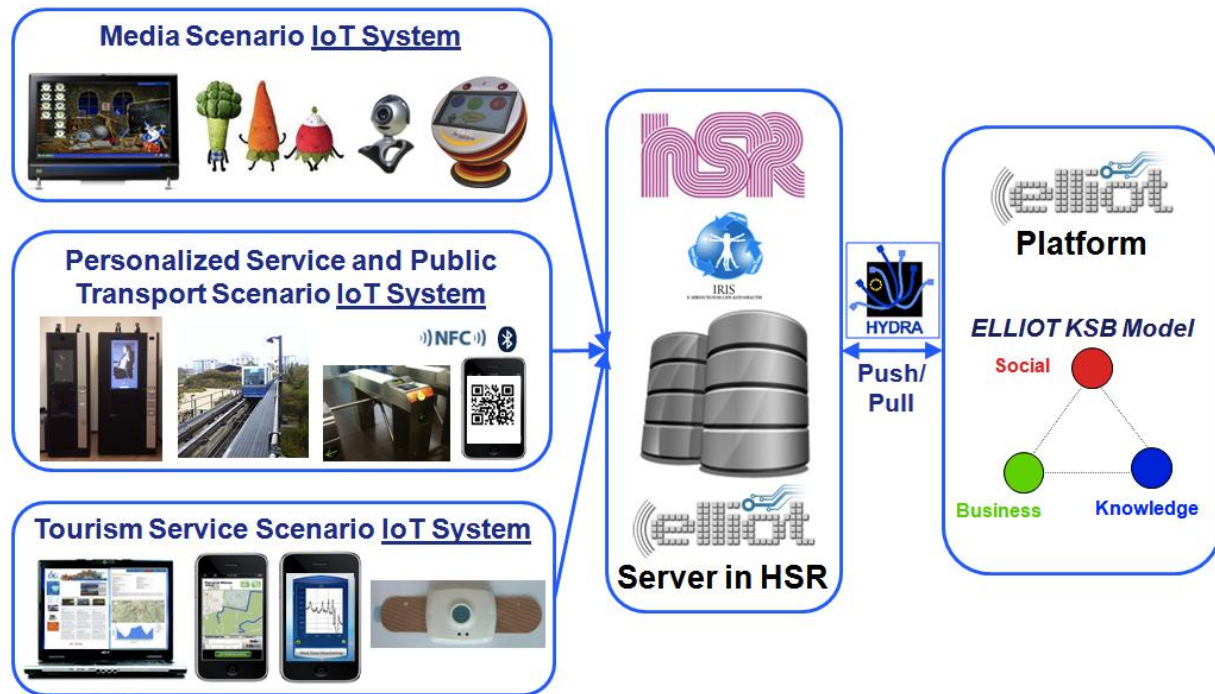



Figure 11: Overall view of the way in which our scenarios communicate with the ELLIOT Platform

The way in which data are managed in terms of privacy protection before they are stored within the OSR repository can be viewed in the diagram below.

	ELLIOT – Experiential Living Lab for the Internet Of Things	Project N.	258666
	D4.3.2 – Report on IOT Living Labs Continuous Exploration and Evaluation (interim)	Date	31.08.2012

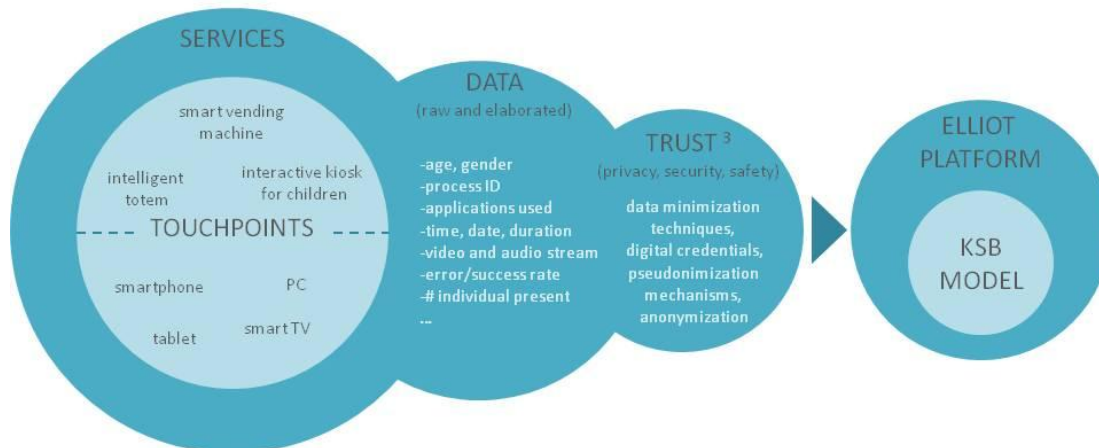



Figure 12: Data flow from our services and touchpoints to the ELLIOT Platform

4.2 Experiment Lessons Learned und Updates Relative to D4.3.1

The Experimentation phase of the “Media Scenario” commenced about a year ago and was described in the paper “An Internet of Things enabled Interactive Totem for Children in a Living Lab setting” [2] is still evolving and becoming increasingly richer with methods and tools for the automatic gathering of data which have proven to be reliable and effective systems able to substitute or support traditional data gathering methods which for the majority are human driven.

Two of the methods for the automatic gathering of data will be briefly discussed, in the first case focusing on the drawbacks, in the second on the advantages:

- Using a video camera for the counting of individuals in front of the totem has been deemed as unreliable. This is caused by the sharp differences in the height of the children in the paediatric ward, ranging from an average of 90 cm of a 4 year old child to over 170 cm of a teenager, putting at risk the trustworthiness of the data from the sensors. If this data is acquired in an approximate manner, as in this case, it is not sufficient in providing a factual and objective way to measure presences.
- The ability to map data, such as the usability logs of the system in a predefined model such as the KSB model, makes comparing two different system levels more streamlined (for example as in the case where the system is evaluated before and after a game is introduced for pure entertainment). This, even if mediated by a phase of traditional ethnographic research where user interactions with the technology are decoded via a qualitative analysis of the user experience, sets the foundations for a more direct and objective benchmarking system where bias observations introduced by observers can be

	ELLIOT – Experiential Living Lab for the Internet Of Things	Project N.	258666
	D4.3.2 – Report on IOT Living Labs Continuous Exploration and Evaluation (interim)	Date	31.08.2012

avoided.

4.2.1 *Design Changes*

Due to the issues encountered in other scenarios as previously described, the causes of the errors were analysed and countermeasures were devised. For example, in the case of the vending machine scenario, it was decided to extend the experimentation phase in order to lengthen the first period of observation with an additional second phase where the data collected from the IOT system was validated. This led to an augmented use of resources previously allocated for this activity, though this was compensated with the staffing of individuals of a lower experience level. At the same time, the observation analysis phase was modified by the involvement of different and variegated competences and points of view so as to better understand how to frame the KSB model within traditional and more consolidated design research techniques.

Nevertheless, the entire Living Lab process of the City of the Future Living Lab was enriched by this experience, proving to be more consolidated and scientifically more credible, as demonstrated by the award received by the International Academy, Research and Industry Association (IARIA) as Best Paper⁴ of the SMART 2012 Conference, the First International Conference on Smart Systems, Devices and Technologies held in Stuttgart (Germany) between May 27th and June 1st, for the paper entitled “How to Co-Create Internet of Things-enabled Services for Smarter Cities” [3].

4.2.2 *Data Collection Changes*

The methods initially envisioned have not been changed at the moment, even if a more careful analysis of the specifications of the data collection systems was carried out. The images below, for example, illustrate the different camera positions taken into consideration for the vending machines.

⁴ <http://www.iaria.org/conferences2012/AwardsSMART12.html>

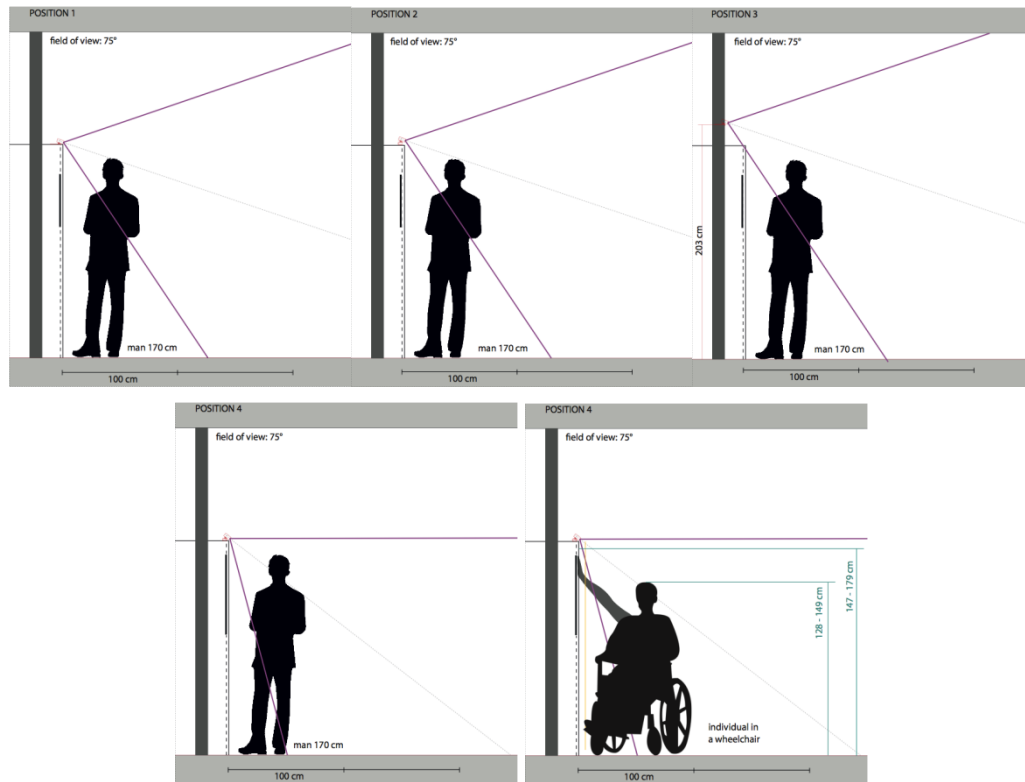

Figure 13: Drawings illustrating the different positions hypothesized and studied for the camera

The research team is nonetheless thinking of ways of better integrating the qualitative analysis phase and the data collection phase through traditional methods such as questionnaires and interviews. If the latter were elaborated in an automatic manner, they could be implemented via digital platforms which could also forward data to the ELLIOT platform.

4.2.3 Data Analysis Changes

The techniques used for the analysis of data are continuously evolving, and this plays an important role in our strategic plan. It is therefore redundant to propose hypotheses for their change, since it is superfluous to decide a priori the method to be used in a future phase. This theme is of such great interest and pertinence that we constantly monitor all proposals made from the academic and industrial worlds in order to experiment with and apprehend techniques that are at the frontier of experimental data.

For this reason we would like to report only a few of the texts analysed recently will be reported on, as an exemplification of the most interesting scientific publications come across:

- “Meaningful Measures: Valid Useful User Experience Measurement (VUUM)” [4]

	ELLIOT – Experiential Living Lab for the Internet Of Things	Project N.	258666
	D4.3.2 – Report on IOT Living Labs Continuous Exploration and Evaluation (interim)	Date	31.08.2012

- “Developing Usability Methods for Multimodal Systems: The Use of Subjective and Objective Measures” [5]
- “Classifying and Selecting UX and Usability Measures” [6]
- “Towards Practical User Experience Evaluation Methods” [7]
- “Comparing UX Measurements, a case study” [8]

4.3 Participants

The City of the Future Living Lab is constrained by its own ecosystem which in turn can be further narrowed according to the experimental needs of the Living Lab Manager (eServices for Life and Health unit). In certain cases, as in the one involving the vending machine scenario, it is completely open and therefore exposed to the 25,000 visitors OSR receives daily, as the image below shows.

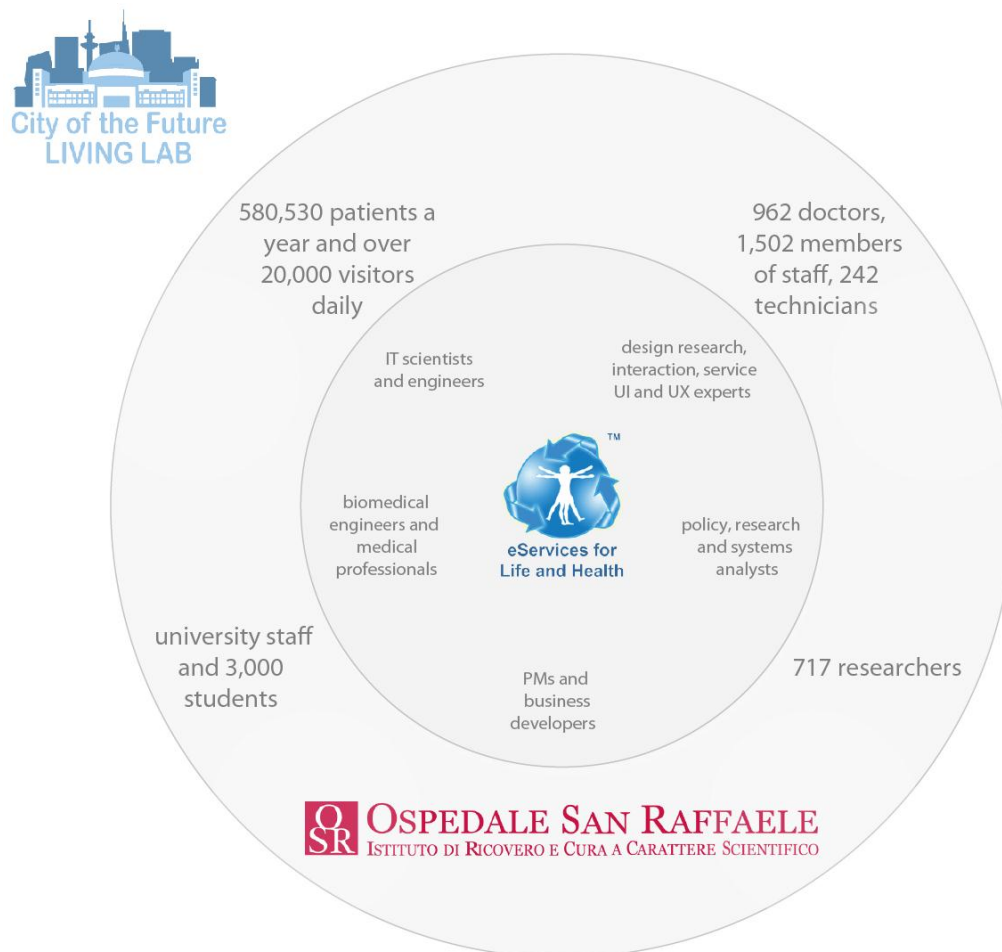



Figure 14: An image illustrating the ecosystem of City of the Future Living Lab

	ELLIOT – Experiential Living Lab for the Internet Of Things	Project N.	258666
	D4.3.2 – Report on IOT Living Labs Continuous Exploration and Evaluation (interim)	Date	31.08.2012

In other cases and when necessary, the products and services are exposed to a much more restricted number of users, as with for example the media scenario where only the patients of a single ward are involved, and these are subsequently filtered according to their age, abilities and by other specifications required by the scenario.

4.4 Data Collection

4.4.1 Sensor Data

The following table illustrates all the data collected via the IOT system for the vending machine scenario, derived from the touch screen, video camera, proximity sensor, food dispenser, and smart card reader, as well as from the activities registered by the software as system logs pertinent to the Graphic User Interface.

Table 24: Data collected via the IOT system

Log Id	Date	Message	Description
	06/12/2012 14:32	<Presence> <Sensor>Proximity</Sensor> <Persons>1</Persons> </Presence>	A presence is detected by the proximity sensor <Sensor> = Proximity/FaceCounter
	06/12/2012 14:32	<Application> <StartSession>anonymous</StartSession> </Application>	The use session begins since the proximity sensor detects a presence
	06/12/2012 14:32	<Presence> <Sensor>FaceCounter</Sensor> <Persons>0</Persons> </Presence>	The face count system detects 0 faces
	06/12/2012 14:32	<Presence> <Real>1</Real> </Presence>	The estimated number of people present is equal to 1
	06/12/2012 14:32	<Selection> <Where>TopList</Where> <Category>Barrette</Category> </Selection>	The user selects the “Barrette” (cereal bar) category from the top menu
	06/12/2012 14:32	<Selection> <Where>QuickList</Where> <Product>Gran cereale Mele e Cannella</Product> </Selection>	The user selects “Gran Cereale Mele e Cannella” (Grancereale Apple and Cinnamon cereal bar) from the product list to view its details.
	06/12/2012 14:32	<Selection> <Where>ProductDetail</Where> <Tab>TabIngredienti</Tab> </Selection>	The user selects the tab regarding the product’s ingredients list to view its content
	06/12/2012 14:32	<Selection> <Where>ProductDetail</Where>	The user selects the tab regarding the product’s



ELLIOT – Experiential Living Lab for the Internet Of Things		Project N.	258666
D4.3.2 – Report on IOT Living Labs Continuous Exploration and Evaluation (interim)		Date	31.08.2012

		<Tab>TabValoriNutrizionali</Tab> </Selection>	<i>nutritional values to view its content</i>
06/12/2012 14:32		<Purchase> <Where>ProductDetail</Where> <Product>Gran cereale Mele e Cannella</Product> </Purchase>	<i>The user purchases “Gran Cereale Mele e Cannella” (Grancereale Apple and Cinnamon cereal bar)</i>
06/12/2012 14:32		<Multimedia> <Playing>>true</Playing> <Type>Video</Type> <Category>Product</Category> <URI>/ProdottoAlimentare/Video/1</URI> </Multimedia>	<i>Multimedia content (such as a video) concerning the selected product is played <Category> = General/ProductType/Product</i>
06/12/2012 14:32		<Presence> <Sensor>Proximity</Sensor> <Persons>1</Persons> </Presence>	<i>A presence is detected by the proximity sensor</i>
06/12/2012 14:32		<Presence> <Sensor>FaceCounter</Sensor> <Persons>0</Persons> </Presence>	<i>The face count system detects 0 faces</i>
06/12/2012 14:32		<Presence> <Real>1</Real> </Presence>	<i>The estimated number of people present is equal to 1</i>
06/12/2012 14:32		<Presence> <Sensor>Proximity</Sensor> <Persons>1</Persons> </Presence>	<i>A presence is detected by the proximity sensor</i>
06/12/2012 14:32		<Presence> <Sensor>FaceCounter</Sensor> <Persons>1</Persons> </Presence>	<i>The face count system detects 1 face</i>
06/12/2012 14:32		<Presence> <Real>1</Real> </Presence>	<i>The estimated number of people present is equal to 1</i>
06/12/2012 14:32		<Presence> <Sensor>Proximity</Sensor> <Persons>1</Persons> </Presence>	<i>A presence is detected by the proximity sensor</i>
06/12/2012 14:32		<Presence> <Sensor>FaceCounter</Sensor> <Persons>2</Persons> </Presence>	<i>The face count system detects 2 faces</i>
06/12/2012 14:32		<Presence> <Real>2</Real> </Presence>	<i>The estimated number of people present is equal to 2</i>
06/12/2012 14:32		<Multimedia> <Playing>>false</Playing> </Multimedia>	<i>End of the multimedia content played</i>
06/12/2012 14:32		<Selection> <Where>TopList</Where> <Category>Frullati</Category> </Selection>	<i>The user selects the “Frullati” (fruit shake) category from the top menu</i>
06/12/2012 14:32		<Purchase> <Where>QuickList</Where> <Product>Storie di Frutta Pesca Uva e Albicocca</Product> </Purchase>	<i>The user purchases “Storie di Frutta Pesca Uva e Albicocca” (Storie di Frutta Peach Grape and Apricot fruit shake)</i>

	ELLIOT – Experiential Living Lab for the Internet Of Things	Project N.	258666
	D4.3.2 – Report on IOT Living Labs Continuous Exploration and Evaluation (interim)	Date	31.08.2012

06/12/2012 14:32	<pre><Multimedia> <Type>Video</Type> <Category>Product</Category> <URI>/ProdottoAlimentare/Video/8</URI> </Multimedia></pre>	<i>Multimedia content (such as a video) concerning the selected product is played</i>	
06/12/2012 14:32	<pre><Presence> <Sensor>Proximity</Sensor> <Persons>1</Persons> </Presence></pre>	<i>A presence is detected by the proximity sensor</i>	
06/12/2012 14:32	<pre><Presence> <Sensor>FaceCounter</Sensor> <Persons>0</Persons> </Presence></pre>	<i>The face count system detects 0 faces</i>	
06/12/2012 14:32	<pre><Presence> <Real>1</Real> </Presence></pre>	<i>The estimated number of people present is equal to 0</i>	
06/12/2012 14:32	<pre><Presence> <Sensor>Proximity</Sensor> <Persons>1</Persons> </Presence></pre>	<i>A presence is detected by the proximity sensor</i>	
06/12/2012 14:32	<pre><Presence> <Sensor>FaceCounter</Sensor> <Persons>1</Persons> </Presence></pre>	<i>The face count system detects 1 face</i>	
06/12/2012 14:32	<pre><Presence> <Real>1</Real> </Presence></pre>	<i>The estimated number of people present is equal to 1</i>	
06/12/2012 14:32	<pre><Presence> <Sensor>Proximity</Sensor> <Persons>1</Persons> </Presence></pre>	<i>A presence is detected by the proximity sensor</i>	
06/12/2012 14:32	<pre><Presence> <Sensor>FaceCounter</Sensor> <Persons>3</Persons> </Presence></pre>	<i>The face count system detects 3 faces</i>	
06/12/2012 14:32	<pre><Presence> <Real>3</Real> </Presence></pre>	<i>The estimated number of people present is equal to 3</i>	
06/12/2012 14:32	<pre><Selection> <Where>InfoMobility</Where> <Tab>TabMappaSanRaffaele</Tab> </Selection></pre>	<i>The user selects the tab containing the map of the San Raffaele within the “Info Mobility” service</i>	
06/12/2012 14:32	<pre><Selection> <Where>InfoMobility</Where> <Tab>TabMetropolitanaLeggera</Tab> </Selection></pre>	<i>The user selects the tab containing information regarding the light rail line (Metropolitana Leggera) within the “Info Mobility” service</i>	
06/12/2012 14:32	<pre><Selection> <Where>InfoMobility</Where> <Tab>TabServiziATM</Tab> </Selection></pre>	<i>The user selects the tab containing information regarding the ATM (Transport for Milan) service within the “Info Mobility” service</i>	

06/12/2012 14:32	<pre><Selection> <Where>InfoMobility</Where> <DirectionsTo>loreto</DirectionsTo> </Selection></pre>	<i>The user obtains directions from the hospital to “Loreto” via the the ATM (Transport for Milan) service</i>
06/12/2012 14:32	<pre><Selection> <Where>InfoMobility</Where> <DirectionsTo>piazza duomo</DirectionsTo> </Selection></pre>	<i>The user obtains directions from the hospital to “Piazza Duomo” via the the ATM (Transport for Milan) service</i>
06/12/2012 14:32	<pre><Application> <StopSession>anonymous</StopSession> </Application></pre>	<i>End of the session. This log is registered when the ScreenSaver is launched, therefore in order to have a more precise idea of when the session ended one must subtract the timeout of the Screensaver from this timestamp (reported in the following log)</i>
06/12/2012 14:32	<pre><Application> <ScreenSaverRunning>>true</ScreenSaverR unning> <ScreenSaverTimeout>10</ScreenSaverTim eout> </Application></pre>	<i>ScreenSaver active</i>
06/12/2012 14:32	<pre><Application> <ScreenSaverRunning>>false</ScreenSaver Running> </Application></pre>	<i>ScreenSaver deactivated, a session is about to begin</i>
06/12/2012 14:32	<pre><Application> <StartSession>authenticated</StartSess ion> <Gender>M</Gender> <Age>27</Age> <Authentication>SmartCard</Authenticat ion> </Application></pre>	<i>Start of a new session is authenticated: the user has inserted a SmartCard</i>
...
06/12/2012 14:32	<pre><Application> <StopSession>authenticated</StopSessio n> </Application></pre>	<i>End of the authenticated session (the Smart Card was removed)</i>

4.4.2 Observation and Survey Data

For the vending machine scenario, the observation phase consisted of different stages: the first one comprised of a questionnaire administered to 10 interviewees recruited onsite. The questionnaire consisting of 7 questions had the aim of understanding user attitudes to the world of vending, their perception of the space in general and their outlook towards interactive vending machines. The first phase of the questionnaire was used to collect demographic details of the interviewee, whilst the second part was composed of both closed and open ended questions that were designed to be as succinct and to the point as possible since we wanted to take away as little

time as possible from the interviewees. We asked them how many times a week or per day they use vending machines, what their feeling was of the space and what message they felt the space communicated, how they felt towards an interactive screen and whether this acted by adding value to their experience or as a deterrent.



Figure 15: Images showing the interview phase

Date and time of day: <input type="text"/>		<p>4) What do you think is the objective of this initiative? What do you understand of why this space has been created?</p> <input type="text"/> <p>5) What are your impressions of the space? Could you comment the graphics, the colors, the texts, the icons...</p> <input type="text"/> <p>6) Who do you think this initiative belongs to?</p> <input type="text"/> <p>7) Does the interactive screen bring an added value to the vending machine or is it a deterrent?</p> <input type="text"/>										
Age: <table border="1"> <tr><td><input type="checkbox"/></td><td>18-25</td></tr> <tr><td><input type="checkbox"/></td><td>26-35</td></tr> <tr><td><input type="checkbox"/></td><td>36-45</td></tr> <tr><td><input type="checkbox"/></td><td>46-64</td></tr> <tr><td><input type="checkbox"/></td><td>65 and above</td></tr> </table>			<input type="checkbox"/>	18-25	<input type="checkbox"/>	26-35	<input type="checkbox"/>	36-45	<input type="checkbox"/>	46-64	<input type="checkbox"/>	65 and above
<input type="checkbox"/>	18-25											
<input type="checkbox"/>	26-35											
<input type="checkbox"/>	36-45											
<input type="checkbox"/>	46-64											
<input type="checkbox"/>	65 and above											
Gender: <table border="1"> <tr><td><input type="checkbox"/></td><td>Male</td></tr> <tr><td><input type="checkbox"/></td><td>Female</td></tr> </table>		<input type="checkbox"/>	Male	<input type="checkbox"/>	Female							
<input type="checkbox"/>	Male											
<input type="checkbox"/>	Female											
Reason for being at OSR: <table border="1"> <tr><td><input type="checkbox"/></td><td>Patient</td></tr> <tr><td><input type="checkbox"/></td><td>Parent</td></tr> <tr><td><input type="checkbox"/></td><td>Visitor</td></tr> <tr><td><input type="checkbox"/></td><td>Student</td></tr> <tr><td><input type="checkbox"/></td><td>Works at OSR</td></tr> </table>		<input type="checkbox"/>	Patient	<input type="checkbox"/>	Parent	<input type="checkbox"/>	Visitor	<input type="checkbox"/>	Student	<input type="checkbox"/>	Works at OSR	
<input type="checkbox"/>	Patient											
<input type="checkbox"/>	Parent											
<input type="checkbox"/>	Visitor											
<input type="checkbox"/>	Student											
<input type="checkbox"/>	Works at OSR											
Job title: <input type="text"/>												
<p>1) Is this the first time that you see/use an interactive vending machine?</p> <table border="1"> <tr><td><input type="checkbox"/></td><td>Yes</td></tr> <tr><td><input type="checkbox"/></td><td>No</td></tr> </table>		<input type="checkbox"/>	Yes	<input type="checkbox"/>	No							
<input type="checkbox"/>	Yes											
<input type="checkbox"/>	No											
<p>2) How often do you use vending machines?</p> <table border="1"> <tr><td><input type="checkbox"/></td><td>Yes – once a day</td></tr> <tr><td><input type="checkbox"/></td><td>Yes – more than once a day</td></tr> <tr><td><input type="checkbox"/></td><td>Yes – once a week</td></tr> <tr><td><input type="checkbox"/></td><td>Yes – more than once a week</td></tr> <tr><td><input type="checkbox"/></td><td>No</td></tr> </table>		<input type="checkbox"/>	Yes – once a day	<input type="checkbox"/>	Yes – more than once a day	<input type="checkbox"/>	Yes – once a week	<input type="checkbox"/>	Yes – more than once a week	<input type="checkbox"/>	No	
<input type="checkbox"/>	Yes – once a day											
<input type="checkbox"/>	Yes – more than once a day											
<input type="checkbox"/>	Yes – once a week											
<input type="checkbox"/>	Yes – more than once a week											
<input type="checkbox"/>	No											
<p>3) If you answered no to the previous question, how come you don't use them often?</p> <input type="text"/>												

Figure 16: A sample of the questionnaire administered to interviewees

For the second phase of the observation, City of the Future Lab chose a simple, effective and validated usability evaluation method to use with interviewees in the near future in order to

	ELLIOT – Experiential Living Lab for the Internet Of Things	Project N.	258666
	D4.3.2 – Report on IOT Living Labs Continuous Exploration and Evaluation (interim)	Date	31.08.2012

capture insights regarding users' perception of effectiveness, satisfaction and engagement in relation to the user interface offered by the vending machines. The method is called think aloud and has been described by Jakob Nielsen Ph.D. and world renown usability pioneer as being "*the single most valuable usability engineering method*" [9]. It has been used for the past 20 years, producing sound insight across a number of user interfaces of different nature.

The method consists of assigning a number of tasks to a set of interviews and asking them to continuously think out loud — that is, verbalise their thoughts as they move through the user interface – as they complete each task. The moderator analyses facial and body language, the words used, how much time it takes for each interviewee to complete each task and to what extent each task is completed correctly. Photos, videos and audio recording are made to document the method. The moderator can probe and ask questions to encourage being careful not to influence the interviewee in order to attain feedback if he/she finds it difficult to express a thought or emotion. Otherwise the moderator observes the interviewee. It was decided to hold the think aloud exercises inside the Temporary Store rather than in the City of the Future closed labs in order to collect the most spontaneous and vivid feedback as possible and to put interviewees at ease.

Think aloud - exercise

INTRO: TBD

FIRST IMPRESSIONS

Space

- Before we approach the vending machines together, Could I ask you to comment the space? What are your impressions of the structure and layout, of the graphics, the colors, the text, the icons...
- What do you think the objective of this initiative is? Why do you think this has all been set up for?
- Who do you think is behind this initiative?
- Who do you think this space was designed for? Who do you think is the typical person who would use this space?

Landing Page

- Before touching the screen, could you describe to me your first impressions of what you see?
- What are the options you see? What do they represent? And what do they do?
- Let's say you were exploring the vending's screen. What would you touch first (without touching)? And what do you expect to happen?

EXPLORATION

Now you may touch the screen, touch wherever you want. I would like to ask you if you speak out loud what you are thinking as you explore the vending, so that I can hear what you are saying in your mind and participate with you to your experience... (give 5 mins to explore)

Probe: For each page visited (therefore product detail, purchase/product distribution, menu detail, purchase/distribution of the menu, infomobility) ask the following questions:

- Could you describe to me what are your first impressions of this new page? What do you think of the layout, the graphics, the colors, the texts...
- Could you describe to me the options you see and what you think they do?

Once completed, go onto home page and refer to infomobility if not explored

Infomobility

- Did you notice this before? Why/why not? What do you think happens if you were to touch here? (TOUCH)
- Could you describe to me your first impressions of this screen? What do you think of the layout, the graphics, the color, the texts, the icons...
- Could you tell me what options you see and what you think they do?

TASKS

Now I would like to you complete a series of activities for me. Even in this case I would like to ask you to say out loud what you are thinking, so that I can hear what is on your mind and participate with you to the experience.

Task 1: order a smoothie

I would like you to order a mixed berry fruit smoothie. Remember to talk you way through the activity, I will listen and take notes, I will not be able to help you...

Verify:

- primary and secondary errors
- time needed to complete the activity
- if activity completed with success or not
- emotions expressed through words, body language and facial expressions.

Task 2: order a menu

I would now like you to order menu "XX" (according tot ime of day). Remember to talk you way through the activity, I will listen and take notes, I will not be able to help you...

Verify:

- primary and secondary errors
- time needed to complete the activity
- if activity completed with success or not
- emotions expressed through words, body language and facial expressions.

Task 3: directions from OSR to Lambrate metro station

I would now like to ask you to find me the directions from the hospital to the metro station of Lambrate. Remember to talk you way through the activity, I will listen and take notes, I will not be able to help you...

Verify:

- primary and secondary errors
- time needed to complete the activity
- if activity completed with success or not
- emotions expressed through words, body language and facial expressions.

Figure 17: A sample of the Think aloud exercises and questionnaire administered to interviewees

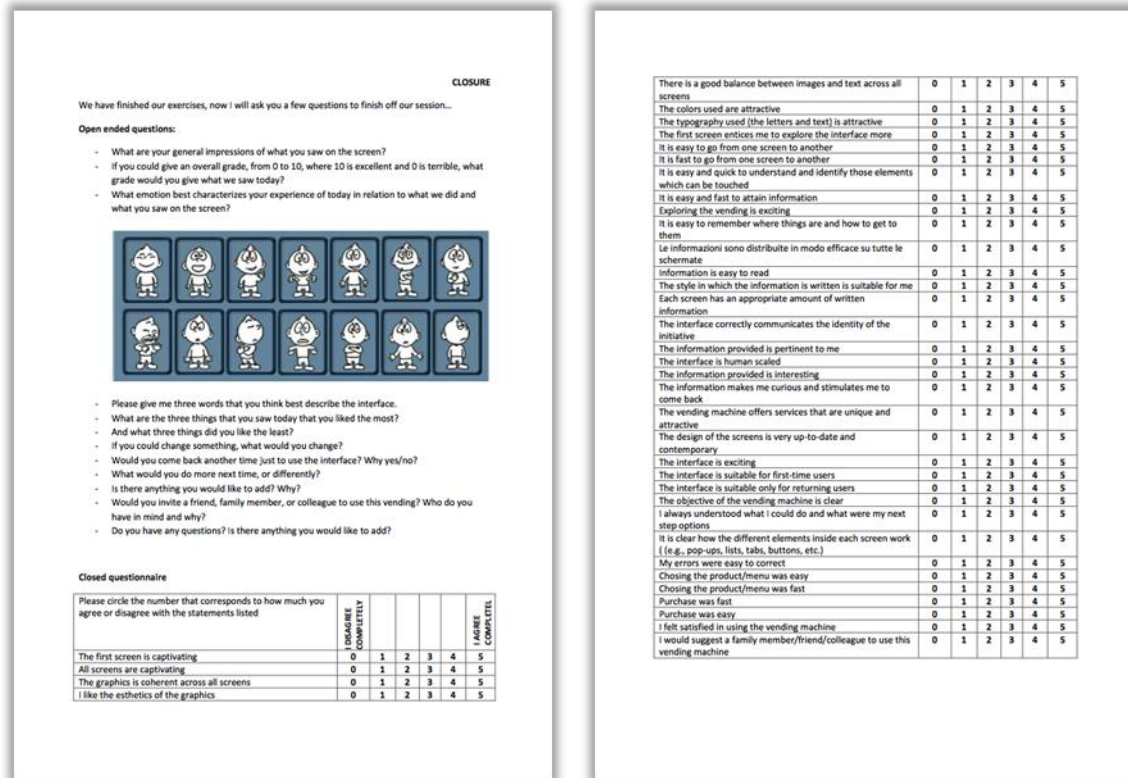

Figure 18: A sample of the Think aloud exercises and questionnaire administered to interviewees

4.5 Data Pre-processing and Data Analysis

As for the previous chapter, this chapter too will present the data concerning the vending machine scenario since at this point of the project it presents the most interesting case for the understanding of the dynamics which make up the core for the integration with the ELLIOT platform.

4.5.1 Sensor Data Analysis

A number of different Key Performance Indicators have been identified for the elaboration of data. The following table shows those related to the vending machine scenario:

Table 25: KPIs related to the vending machine scenario

KPI ID	Description	How to calculate it
KPI1	# of user sessions per day (session: from proximity detection to non-detection)	An anonymous session begins with this XML element in the log file: <pre><Application> <StartSession>anonymous</StartSession> </Application></pre> or when there is a 30 second pause between two logs. It ends when there are no XML elements for 30 seconds
KPI2	Average duration of a session per day	Average refers to the sum of all session durations in a day, divided by the number of sessions of that day
KPI3	# of products sold per day	Number of <Purchase> elements in a day
KPI4	# of sessions concluded with a purchase	Number of sessions containing a <Purchase> element
KPI5	Average duration of a session per day in which there was a purchase	Average duration of a session containing a <Purchase> element
KPI6	Average duration of a session per day in which there was no purchase	Average duration of a session that does not contain a <Purchase> element
KPI7	Best selling product of the day	Most recurrent <Product> name sub-element in <Purchase> elements of the day
KPI8	# of menus sold/ # of total products sold per day	Number of <Purchase> element containing two <Product> sub-elements divided by the total number of <Purchase> elements of a day
KPI9	# of sessions with access to Infomobility service per day	Number of sessions containing at least a <Selection> element with <Where>InfoMobility</Where> as sub-element
KPI10	# of sessions with access to Infomobility service per day/ # of sessions per day	Number of session containing at least a <Selection> element with <Where>InfoMobility</Where> as sub-element, divided by the number of sessions of the day
KPI11	Average time spent in the Infomobility section per day	Average of the time spent in a day from first <pre><Selection> <Where>InfoMobility</Where> ... </Selection></pre> to any other XML elements or no elements for 30 seconds
KPI12	Average of (Time spent in the Infomobility section/Time spent in that session) per day	Average per day of all the durations of sessions containing at least a <Selection> element with <Where>InfoMobility</Where> as sub-element, divided by the time spent in those same sessions
KPI13	# of errors per day	Number of <Error> elements in a day

The described automated data analyses will be carried out via Elliot platform using the extensible Elliot core platform data analysis component system and FocusLab data analysis services. Automated analyses will be carried out at the end of the experimentation.

A first analysis of sales data was executed manually, and some of the results are illustrated in the graphs below:

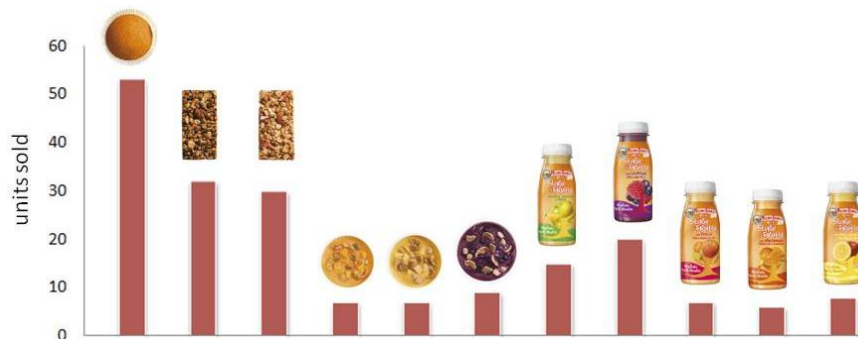

Figure 19: Purchase data of single products for the month of July

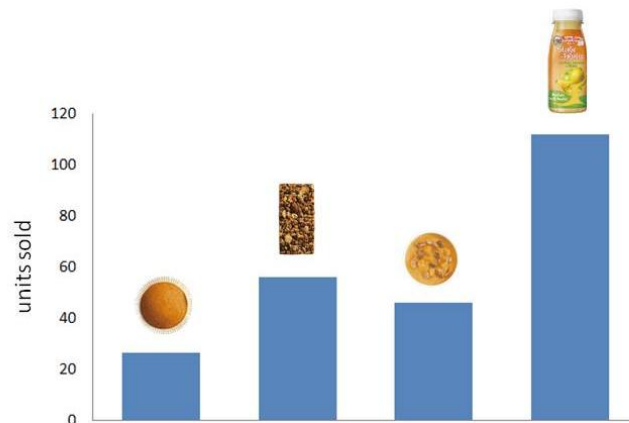

Figure 20: Purchase data per food category for the month of July

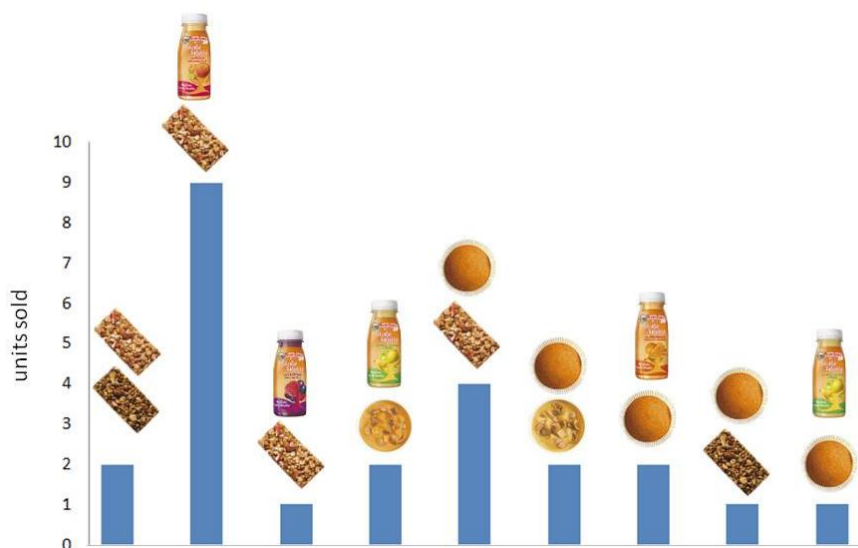

Figure 21: Purchase data of menus for the month of July

4.5.2 Observation and Questionnaire Data Analysis

Mapping of the flow of people in and around the Temporary Store space was deemed as the first and most important task to be accomplished, since it helps to understand when there are peaks of users and therefore when it is best to administer future questionnaires. This activity could have been carried out and managed in an automatic manner via a set of computer vision techniques already available on the market, which would have produced more stable and constant data. Nevertheless the costs of such solutions are still a barrier to their implementation, though we firmly believe that in the short-term this will change. The data collected manually by a team of observers is presented below, and represented in two charts.

Table 26: Table illustrating the number of people who passed by the Temporary Store

	Number of people who passed by the Temporary Store	% affluence of the day	Number of people who looked at the space or poster or both (adults)	% of who looked compared to who walked by	People who entered the Temporary Store	% of who entered compared to who passed by
07:00-08:00	403	4,9%	35	8,68%	1	0,25%
08:00-09:00	581	7,0%	31	5,34%	0	0,00%
09:00-10:00	738	8,9%	86	11,65%	4	0,54%
10:00-11:00	782	9,5%	23	2,94%	1	0,13%
11:00-12:00	931	11,3%	216	23,20%	5	0,54%
12:00-13:00	734	8,9%	139	18,94%	3	0,41%
13:00-14:00	901	10,9%	203	22,53%	4	0,44%
14:00-15:00	920	11,2%	47	5,11%	3	0,33%
15:00-16:00	648	7,9%	82	12,65%	1	0,15%
16:00-17:00	571	6,9%	120	21,02%	6	1,05%
17:00-18:00	444	5,4%	106	23,87%	3	0,68%
18:00-19:00	312	3,8%	77	24,68%	6	1,92%
19:00-20:00	281	3,4%	76	27,05%	3	1,07%
TOTALE	8246	100%	1241	15,05%		

Passers by who walked into the Temporary Store

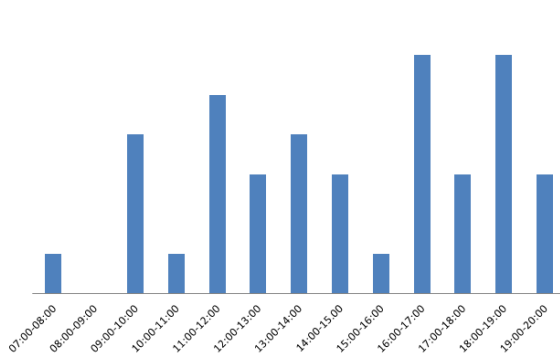

Survey of passers by in the Shopping area of OSR

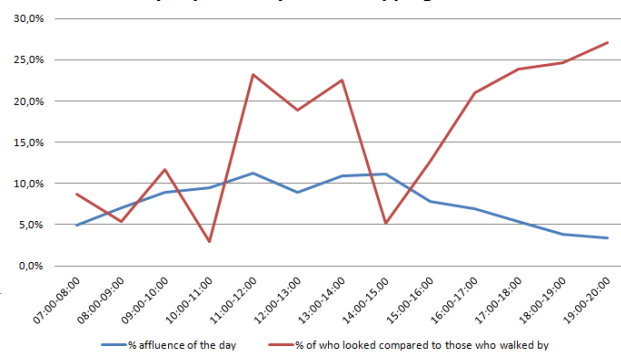

Figure 22: Graphs illustrating the number of individuals who passed by the Temporary store as well as those who passed by and looked at the graphics or entered the space

Following the mapping of users in and around the Temporary Store space, ten individuals were selected randomly and interviewed within the Temporary Store space, as shown in the table below.

Table 27: Table illustrating the demographic details of the people interviewed

Age	Gender	Current occupation	Reason for being at OSR
51	F	Elementary school teacher	Family member of a patient at OSR
69	M	Marketing consultant	At OSR for a check up
67	F	Housewife	Family member of a patient at OSR
25	F	Researcher	Works in OSR
51	M	Cab driver	Works in OSR
45	F	Housewife	Family member of a patient at OSR
55	M	Surgeon	Works in OSR
47	M	Shop owner	Works in OSR
50	M	Biomedic marketing consultant	Works in OSR
21	F	Bartender	Works in OSR

The feedback provided by interviewees to the questionnaire is as follows:

Questions

“What does this space represent to you?” and “What is the objective or message of this space?”

Verbatim

“For me this initiative is to offer people food and drinks that can promote well-being and that promote healthy eating... A journey towards a better way of life”

“The aim of this space is to promote the individual’s health at a global level, from a nutritional, physical, emotional and social point of view”

“For me it is a space where they sell foods that are nutritionally well-balanced, possibly even diet or light foods”

“This is for people who want to eat something healthy even if they are on the move”

“I feel this is a way to better welcome people who come to the hospital”

“It is a place where humans and machines can come together in a friendlier manner”

	ELLIOT – Experiential Living Lab for the Internet Of Things	Project N.	258666
	D4.3.2 – Report on IOT Living Labs Continuous Exploration and Evaluation (interim)	Date	31.08.2012

Mind Map

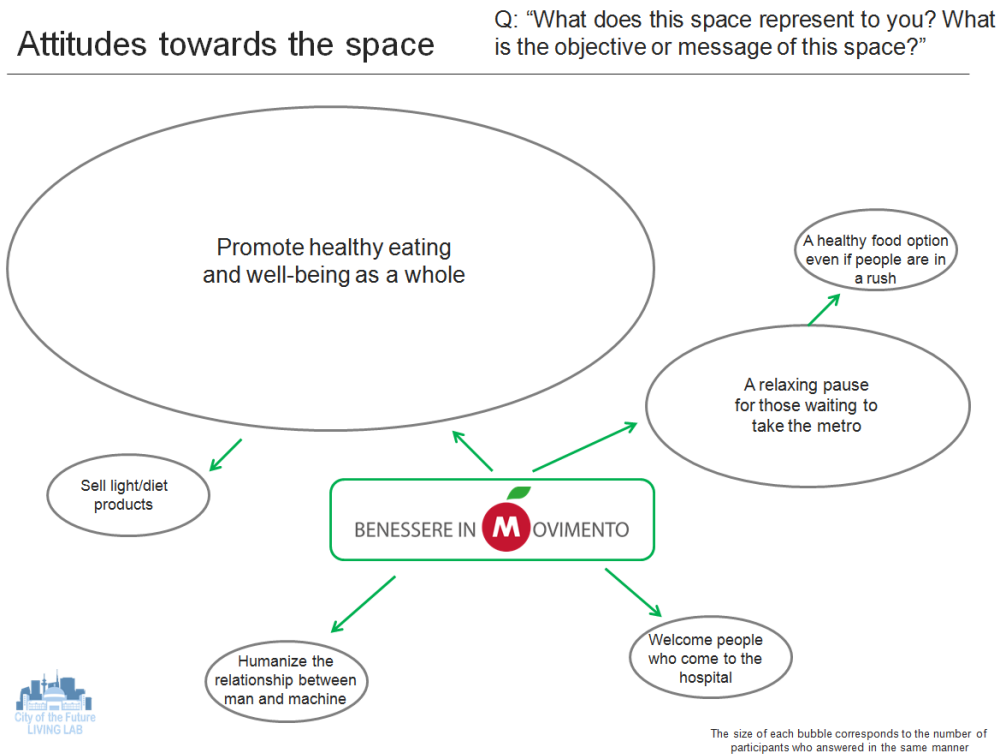



Figure 23: Mind map illustrating user attitudes towards the initiative

Qualitative conclusion about attitudes towards the design of the space

The space conveys the correct message and feeling: the individuals interviewed stated that for them the Temporary Store promotes healthy eating and well-being as a whole, as well as being a space where people on the move can enjoy some relaxing time whilst eating some nutritionally correct food. This means that the layout, the design, the graphics and the information available is sufficient and effective.

The look and feel of the space is described by the majority of interviewees as being strongly eye-catching, attractive and distinctive, as well as being energising, vivid and brilliant. Since the project is very innovative and has a lot to communicate to its users, it was essential to design a space that could draw users to it and therefore the design chosen is successful.

The majority of interviewees were not sure as to who was sponsoring the space. Some suggested possibly the hospital or Barilla since it was the most recognisable logo in the space. This is a positive response in that at this point of the project it is important to convey a message that is unbranded and therefore appealing to all.

	ELLIOT – Experiential Living Lab for the Internet Of Things	Project N.	258666
	D4.3.2 – Report on IOT Living Labs Continuous Exploration and Evaluation (interim)	Date	31.08.2012

Questions

“What are your impressions of this space?”

Verbatim

“The colours put me in such a good mood, they give me energy”

“The whiteness conveys cleanliness, hygiene and airiness”

“The colours are so attractive. The design is modern and elegant. The whole thing together makes this space very different from all other vending areas. It is unique”

“I spend the whole day with my husband here in hospital, this space gives me a breath of fresh air, it is pleasant”

“I like the fact that it is a bit secluded – it makes it more welcoming and relaxing, away from the crowds”

“It is alive, it is playful”

“I feel that if you come from the garages it remains a bit concealed”

Mind Map

Attitudes towards the space

Q: “What are your impressions of this space?”

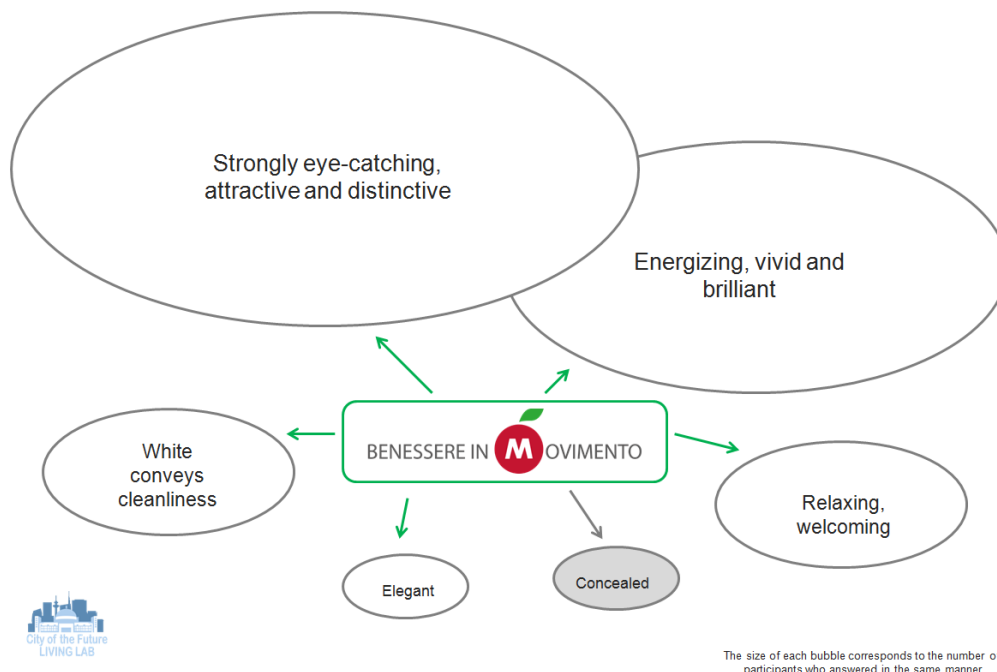



Figure 24: Mind map illustrating user attitudes towards the space

	ELLIOT – Experiential Living Lab for the Internet Of Things	Project N.	258666
	D4.3.2 – Report on IOT Living Labs Continuous Exploration and Evaluation (interim)	Date	31.08.2012

Qualitative conclusion about attitudes towards vending machines in general

The majority of individuals interviewed use vending machines at least once-twice a day, which makes the sample very relevant. The main reason why these individuals go to vending machines is so that they can socialise with colleagues and friends, as well as to have something to eat or drink quickly. These two insights are important since they confirm the top two user requirements previously hypothesised, and which should guide future evolutions of the project.

For those interviewees who do not like to visit vending machines it is because they feel the food offered is of poor quality, or because they cannot enjoy the full service of being pampered as they are in cafés. These two elements are equally important since they disclose unmet needs which should be addressed in the future so as widen the audience of the project and improve the user experience.

Questions

“What are your attitudes towards this kind of interactive vending machine?”

Verbatim

“It certainly adds a little fun. I see a lot of people coming into this space just to play with the screen. I think the screen makes things easier – you see what you want and you touch it and you’re done”

“The screen adds consciousness. People see what they are about to eat before they buy it, without packaging and without gimmicks. Plus you see the ingredients which you don’t see on other vending machines”

“It’s very modern and has a strong appeal. We are all used to screens now”

“You don’t see the actual product, but you get more – you see the ingredients and you see what you’re buying”

“The screen attracts users and improves use. But there is a fine line – if the user has to think too much about how to buy a coffee then the screen is not worth it”

Mind Map

Attitudes towards interactive vending machines

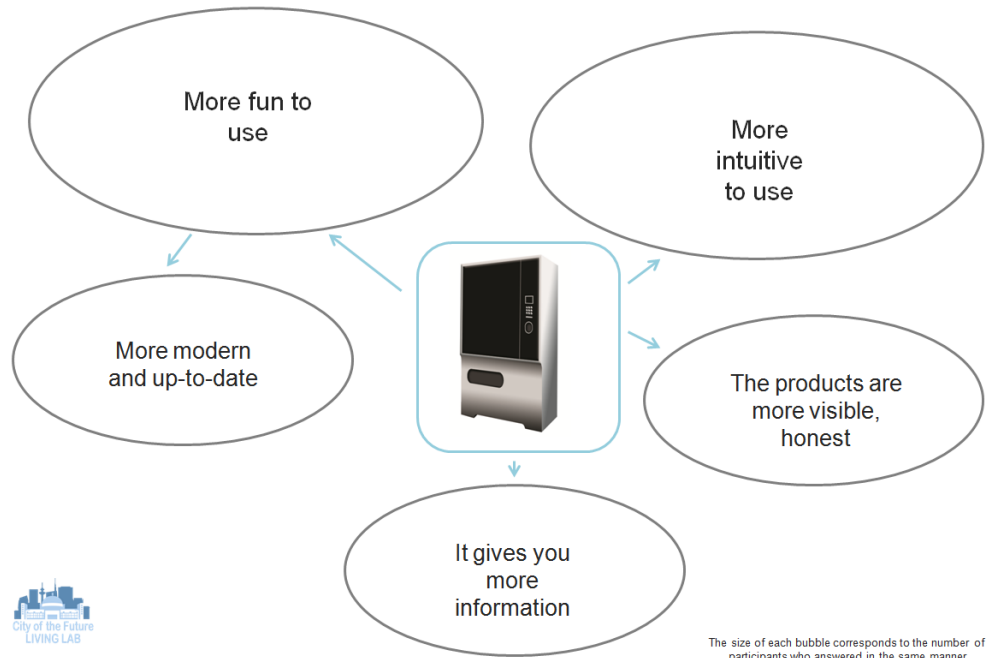



Figure 25: Mind map illustrating user attitudes towards vending machines

Qualitative conclusion about attitudes towards interactive vending machines

Attitudes towards our interactive vending machines were extremely positive, even if 60% of the sample interviewed was between the age of 50 and 69.

The majority of individuals interviewed stated that having screens on the interactive vending machines added to their everyday experience mainly playfulness, but also intuitiveness: being able to see all the products and purchasing them just by touching their picture was felt to be faster and more immediate than traditional vending machines.

What was also noticed by is that many feel that even if one does not see the actual product through a glass window, seeing a picture of it without its packaging makes the food more appealing and honest. Also, having it presented alongside impartial and useful information (such as list of ingredients) was a welcomed bonus since such information cannot be accessed with traditional vending machines.

	ELLIOT – Experiential Living Lab for the Internet Of Things	Project N.	258666
	D4.3.2 – Report on IOT Living Labs Continuous Exploration and Evaluation (interim)	Date	31.08.2012

4.5.3 Data-KSB Mapping

A direct way of associating arbitrary indicators of performance to descriptive parameters of the quality of users’ experiences, as are those of the KSB model, does not exist even though it is undeniable that the challenge is particularly interesting and is of significant importance for the future. The Elliot approach consisted of a comparative analysis between the simultaneous work involving the elaboration of the data from the IOT system in the form of KPIs, alongside observational work using traditional techniques and methodologies executed before and after an activity. This approach has made it possible to draw conclusions regarding the user experience before and after the introduction of modifications to the service deployed, and this proved to be an interesting approach since it helped identify and draw the parameters of the KSB model.

With regards to the IOT system of the vending machines, and more in general of the Temporary Store “Benessere in Movimento”, data concerning the KPIs will be observed and an ethnographic study will be carried out before and after the introduction of new functionalities such as the introduction of music or the presence of a videogame, in order to evaluate the attractiveness of the service offered (parameter S7.1 of the KSB model). The same modus operandi will be carried out for all the other parameters. Even if this method does not tie the KPIs to the KSB parameters in a mathematical way, it will help determine whether a first form of proportionality exists. If the latter were analysed under different scientific aspects (even in an empirical manner) it could prove to have real potential to be explored and would produce a greater impact in terms of business model and scientific research.

	ELLIOT – Experiential Living Lab for the Internet Of Things	Project N.	258666
	D4.3.2 – Report on IOT Living Labs Continuous Exploration and Evaluation (interim)	Date	31.08.2012

5 Green Services [INRIA]

5.1 Experiment Overview

According to the Green Services Evolution process below, the Green Services Use Case has entered phase 2 whereby IoT-based services are implemented, tested and then used.

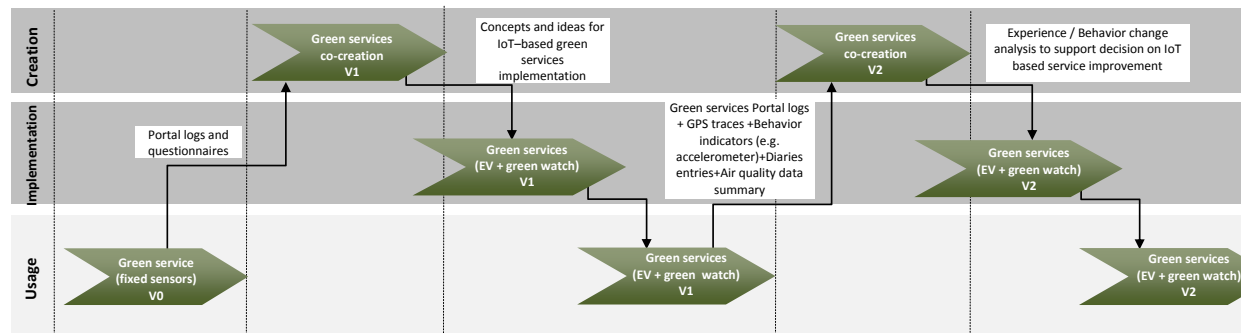

Figure 26 : Green services evolution process (extracted from D4.1, page 45)

D4.3.1 documents experiments run in the frame of phase 0 (*IoT awareness and experience measurement - atmopaca*) and phase 1 (*IoT based green services co-creation v1 - mobility scenario only*).

D4.3.2 document experiments run in the frame of phase 1 (*IoT based green services co-creation v1- Health/Well being scenario*) and phase 2 (*Implementation and Evaluation of selected IoT green services*).

Due to some important delays in manufacturing citizen sensors (the second version of the green watch, a new air quality/noise station) and in selecting/installing/testing air quality/noise sensors on electric vehicles, the evaluation of the green services (v1, v2) will run from mid September until January 2013. The results of the experimentation step on green services (v1, v2) and GS co-creation v2 will be reported in the last deliverable D4.3.3. Some information on IoT data related to the future experiments are presented as an appendix to this deliverable. For this period we have added a new experiment related to the fake green watch in phase 1.

In this deliverable, we report on two experiments according to the co-creation and exploration steps in our Living Lab process related to IoT and health and well-being (cf. D4.3.1 IoT & mobility): one with professionals (environment, health) and one with citizens.

These experiments during the co-creation and exploration step were very rich in order to capture

“what is needed and not what is feasible” as was remarked by one of the ELLIOT reviewers during the first review: we gathered further insight on new smart objects and IoT services (cf. Figure 32) and important feedback related to the use of the green watch from citizens for finalising the definition of the usage scenario with the green watch inside the green services use case.

A special property of the green services use case is that both fake/conceptual smart objects/sensors and real sensors are used and also both Lab and in-contexts studies are performed. Moreover, all activities (in the sense of experiential design activity as defined in D4.1, see for instance Figure 4.33, page 17), benefit from this wide coverage as summarised in Table 28. The green services use case therefore handles both real IoT and conceptual IoT devices (such as the fake green watch in Figure 2) as the focus of ELLIOT is to measure in a Living Lab approach to the user experience of IoT-based services.

Table 28: Comprehensive approach for IoT in Green Services Use Case

	Real IoT object	Fake IoT object
Lab setting	Green watch V1 (exploration)	SmartKeyholder (co-creation)
Living Lab setting	Green watch V2 (t°, Humidity, O3/NO2, GPS) EV sensor (O3-NO2, noise) Pollux air/noise stations (PM10) Arduino-based sensors (PM10)	Fake IoT in GenIoT (co-creation) Fake green watch (exploration)

Please note that not all IoT technical tests that are not performed with end-users are mentioned in the above table nor reported in this deliverable but are a prerequisite for the green services (v1, v2) experimentations.

	ELLIOT – Experiential Living Lab for the Internet Of Things	Project N.	258666
	D4.3.2 – Report on IOT Living Labs Continuous Exploration and Evaluation (interim)	Date	31.08.2012

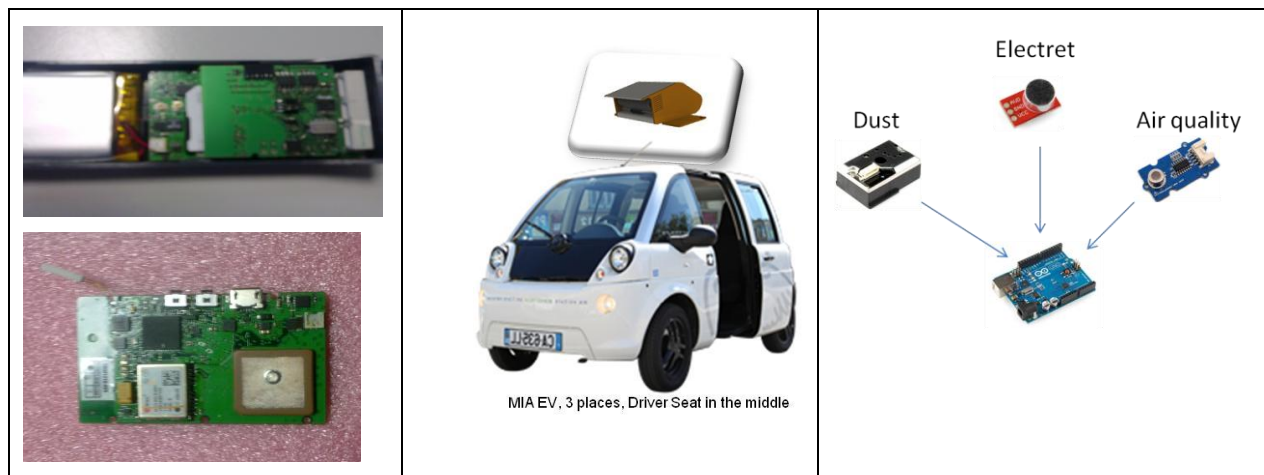

Figure 27: Green watch sensors, EV based sensor, Arduino based Axis sensors



Figure 28: Fake green watch in real context

5.1.1 Experiment Description

Two experiments are reported on in this deliverable. The first one is a replication of the GenIoT co-creation exercise as described in D4.3.1 but with another target group (professionals instead of citizens) and another target use case scenario (green services for health/wellbeing instead of green services for urban mobility). The second experimentation is a fake green watch usage diary exercise. This second experimentation targets a small citizen group and builds on the feedback from previous experimentation reported in D4.3.1 as well as the feedback from all co-creation workshops.

Experiment 1 was run from 29th June to 13th July as part of the overall co-creation exercise summarised in Table 29. Launching of the experimentation happened during an Aloha!

	ELLIOT – Experiential Living Lab for the Internet Of Things	Project N.	258666
	D4.3.2 – Report on IOT Living Labs Continuous Exploration and Evaluation (interim)	Date	31.08.2012

workshop where all participants were present and the GenIoT rules (cf. D4.2.1) were explained to them based on the documentation used in the previous exercise. Aloha! and GenIoT co-creation methods for IoT are documented in [10]. Participants also met on the 5th of July and elaborated on a first clustering of their ideas based on the paper representation of their ideas.

Table 29: Green Services co creation workshops (second batch focusing on Health/wellness)

Co-creation meeting	Aloha!	GenIoT mid-term debriefing	convergence
Nice (sustainable development public structure)	05/07/12 3h00	13/07/12 3h00	September (to be fixed)

All participants could contribute to the co-creation via the customised Ideastream platform as reported in D4.2.1.

	ELLIOT – Experiential Living Lab for the Internet Of Things	Project N.	258666
	D4.3.2 – Report on IOT Living Labs Continuous Exploration and Evaluation (interim)	Date	31.08.2012



The screenshot displays the ELLIOT website interface. At the top left is the ELLIOT logo. A search bar with a 'Recherche' button is located at the top right. The main content area is divided into several sections:

- Inspiration !**: A section for posting ideas and photos, with links to 'Liste des idées', 'Dernières contributions', and 'Derniers commentaires'.
- Les Tops**: A section for top content, with links to 'Tableau de bord', 'Classement des idées', 'Idées les plus commentées', and 'Classement par point'.
- Vos Points**: A section showing 'Vous avez 0 point'.
- Notre veille**: A section for news and updates, featuring 'Derniers flux collectés de Veille ELLIOT santé bien-être' with a date of '20 AOÛT 2012'. It lists several news items with titles like 'de Services et applications sur Air quality & noise (version anglaise)', 'BBC News - Smartphone trial to ca de App pour smartphones', and 'de App pour smartphones'.
- Top des mots-clés**: A section for popular keywords, including 'alerte aération', 'bactéries flamme', 'fumée des bateaux', 'germes insecticide', and 'Lampadaire pollution'.

The main content area is titled 'GENIOT intérieur' and lists various posts with titles and authors, such as 'Diffuseurs de parfum' by MSalvador, 'Escargot' by ALNegri, 'Fumée dans les boîtes de nuit' by MSalvador, 'Bruit de climatisation' by MSalvador, 'Détecter la pollution sur les poignées de portes' by TCollomp, 'Trace de produits' by TCollomp, 'Insecticide avec capteur de produits chimiques (rose) et de pression (bleu)' by FPeron, 'Ventilation avec capteur de poussière (turquoise)' by FPeron, 'Poubelle avec capteur de germes et bactéries (rouge) et de pression (bleu)' by FPeron, 'contrôle des décibels pour les casques audio' by CDebaill, 'CO2 et ventilation indice de confinement d'un lieu clos' by CDebaill, and 'contrôle de l'air intérieur des voitures' by CDebaill. Below this is 'GENIOT hybride' with posts like 'Nuisances animales' by MSalvador and 'Camion de chantier = surpollution' by MSalvador. Then 'GENIOT extérieur' with posts like 'Façades d'immeubles noircies par la pollution' by TCollomp, 'Lampadaire pollution' by QEschapassee, 'Fumée des bateaux' by FPeron, 'Voitures dans rue avec capteur de bruit (vert)' by FPeron, 'Voitures dans rue avec capteur de gaz d'échappement (noir)' by FPeron, and 'pollution quotidienne' by FPeron. Next is 'Scenette Aloha!' with posts like 'Scénette Aloha! : La famille en réseau Air Paca et la poussette intelligente de Mustapha' by ALNegri and 'Scénette Aloha! : Isabelle et les porte clé & spray intelligents' by ALNegri. Finally, 'Autres' with 'capteur limiter de bruit sur chantier' by JChemin. The last section is 'Discussion introductive' with posts like 'Internet des objets pour la santé' by CTiffon, 'Air/bruit : Impacts sur la santé, lois et acteurs' by CTiffon, 'Commercialisation de solution santé/bien être' by CTiffon, and 'Air/bruit : préoccupations des malades, pratiques et astuces développées' by CTiffon.

Figure 29 : List of various productions (in French) by participants

	ELLIOT – Experiential Living Lab for the Internet Of Things	Project N.	258666
	D4.3.2 – Report on IOT Living Labs Continuous Exploration and Evaluation (interim)	Date	31.08.2012



The screenshot shows the ELLIOT website interface. On the left, there are navigation menus for 'Inspiration !' (Postez une idée/photo!, Liste des idées, Dernières contributions, Derniers commentaires) and 'Les Tops' (Tableau de bord, Classement des idées, Idées les plus commentées, Classement par point). The main content area features a search bar and a navigation bar with buttons for 'Voir', 'Votes détaillés', 'Modifier', 'Suivi', 'Workflow', and 'Evaluations'. The featured idea is titled 'pollution quotidienne', posted by FPeron on 07/04/2012. It has 0 votes and is categorized as 'GENIOT extérieur'. The post includes several photographs showing various pollution-related items like a spray can, a trash bin, and cars. Below the images are links to 'Ajouter un commentaire', 'Ajouter une critique', and 'Ajoutez à mes bookmarks'.

Figure 30 : GenIoT On-line idea generation: examples of green services with pictures involving fake sensors



The screenshot shows the ELLIOT website interface. On the left, there are navigation menus for 'Inspiration !' (Postez une idée/photo!, Liste des idées, Dernières contributions, Derniers commentaires) and 'Les Tops' (Tableau de bord, Classement des idées, Idées les plus commentées, Classement par point). The main content area features a search bar and a navigation bar with buttons for 'Voir', 'Votes détaillés', 'Modifier', 'Suivi', 'Workflow', and 'Evaluations'. The featured idea is titled 'Escargot', posted by ALNeqr on 07/09/2012. It has 0 votes and is categorized as 'GENIOT intérieur'. The post includes several photographs showing a smart object and its components. Below the images are links to 'Ajouter un commentaire', 'Ajouter une critique', and 'Ajoutez à mes bookmarks'. The text of the post describes the object as a smart object for collecting and objectifying indoor air quality, designed to help users in their ventilation processes.

Figure 31 : On-line idea generation: post of the co-created new smart object “Escargot” and its services (interior air quality) issued from face-to-face workshop

Discussion threads and visual representation of the services elaborated by the participants (such

	ELLIOT – Experiential Living Lab for the Internet Of Things	Project N.	258666
	D4.3.2 – Report on IOT Living Labs Continuous Exploration and Evaluation (interim)	Date	31.08.2012

as Figure 32 and Figure 33) were also posted on the platform in order to trigger more exchanges (cf. Figure 29, Figure 30, Figure 31).

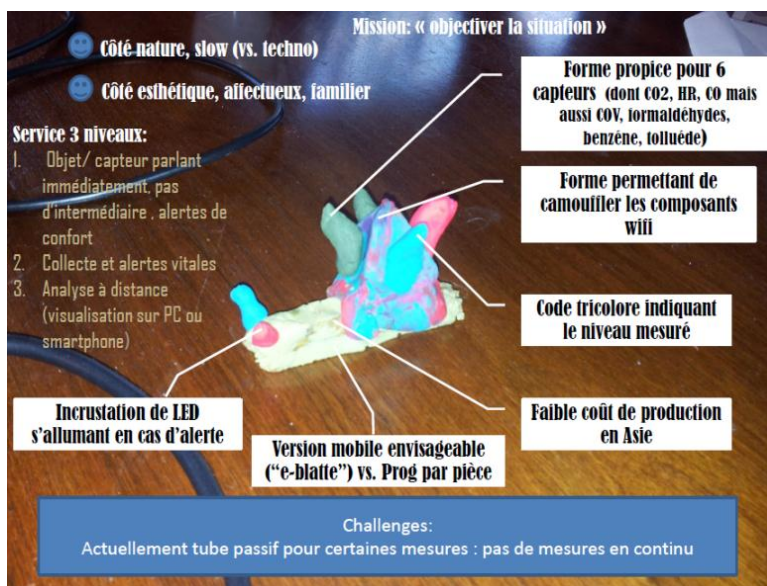

Figure 32 : Zoom on the production of a new “smart object” and services

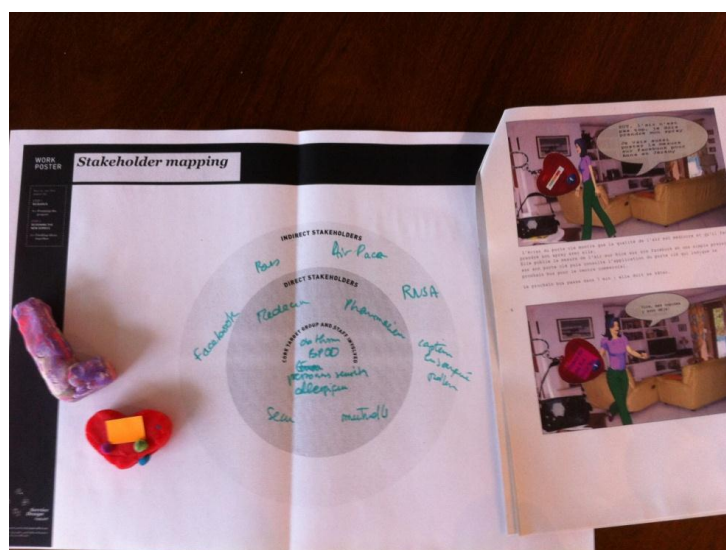

Figure 33: Face-to face workshop productions (Usage scenario, smart key holder) from Experimentation 1

Experimentation 2 was carried out between the 13th of July and the 27th of July. Participants were offered a dummy green watch and were asked to wear it and report about its usage daily. Participants were told that the watch would geo-locate them and would indicate selected

information on their environment (incl. air quality index, Co2, No2, O3, pollen, humidity, temperature, noise and transportation information such as the next bus). Every day, they received an email reminder asking them to fill out the same questionnaire regarding their usage of the watch (detailed information gathered is showed in 5.5.2). Individual interviews in order to debrief and qualify the data gathered were held at the end of the experimentation.

5.1.2 KSB Instantiation

Experimentation 1: although doubts were expressed on its relevance in D4.3.1, it was decided to apply the same KSB instantiation on this new topic. This KSB instantiation, (summarised in Table 30), related to the user experience using on-line idea generation (with the use of fake sensors and productions issued from face-to-face workshops).

Table 30: KSB instantiation for Experimentation 1

	Ref	Properties
Knowledge	K2.4	Conation (Desire)
	K5.1	Self-examination
	K6.1	Team cognitive process
	K7.2	Shared meanings
	K7.4	Group consciousness
Social	S1.1	Social Networking
	S2.1	Communication
	S3.2	Influential behaviour
	S4.3	Rewarding
	S7.1	Attractiveness
	S11.1	Caring

Experimentation 2: The KSB instantiation used here is new compared to D4.3.1. It concerns the user experience related to the *fake green watch in natural context over the course of 10 days*. KSB properties in bold are considered as more important than ones not in bold.

Table 31: KSB instantiation for Experimentation 2

	Ref	Properties
Knowledge	K7.1	Situated Cognition

	ELLIOT – Experiential Living Lab for the Internet Of Things	Project N.	258666
	D4.3.2 – Report on IOT Living Labs Continuous Exploration and Evaluation (interim)	Date	31.08.2012

Social	S7.2	Perceived Appealingness
Business	B.1.5	Ambient Intelligence
	B4.1.	Usefulness

5.1.3 Connection to ELLIOT Platform

5.1.3.1 Experimentation 1

For idea generation, we customised the existing “Ideastream” tool by adding new functionalities and extending the data analysis component. This tool, dedicated to idea generation, is one component of FocusLab inside the ELLIOT platform (cf. the other component based on serious gaming). In this experimentation, the data managed by ELLIOT are issued from the database that stores Ideastream activities.

	ELLIOT – Experiential Living Lab for the Internet Of Things	Project N.	258666
	D4.3.2 – Report on IOT Living Labs Continuous Exploration and Evaluation (interim)	Date	31.08.2012

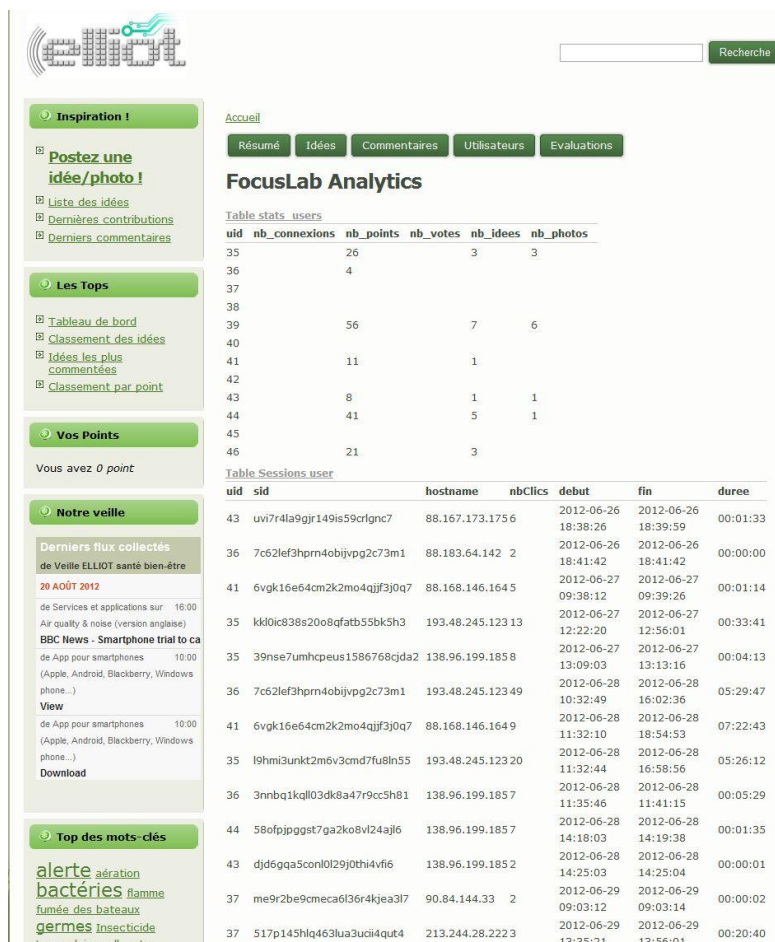



Figure 34 : Indicators/KPIs computed by Ideastream of FocusLab (ELLIOT platform)

The different user profiles (issued from “Sphinx”, see below) were also sent to Elliot in order to document use case in ELLIOT for future use case searches by Living Lab managers using ELLIOT.

5.1.3.2 Experimentation 2

The Sphinx server was used also being a component of FocusLab, allowing 12 experimentations in parallel. A diary questionnaire was designed which was programmed to automatically email a personalised link to the participants every day for two weeks. Diary answers by the participants were recorded directly in the Sphinx database part of the FocusLab component that realises the analysis.

	ELLIOT – Experiential Living Lab for the Internet Of Things	Project N.	258666
	D4.3.2 – Report on IOT Living Labs Continuous Exploration and Evaluation (interim)	Date	31.08.2012

5.1.3.3 Next experimentations

To collect data coming from the future experimentations based on green services (version 1), a data server has been installed within the ICT Usage lab able to collect IoT data (cf. Appendix 8.3) and usage data. It allows an ELLIOT middleware client to send it via push or pull to the ELLIOT Platform. Data will then be sent to the data analysis component of the ELLIOT platform.

5.2 Experiment Lessons Learned and Updates Relative to D4.3.1

5.2.1 Design Changes

In this section we report on the modifications to the used tools and on the methodology followed for the GenIoT exercise, therefore the methodology design changes.

5.2.1.1 Experimentation 1:

As reported in D4.3.1, the ICT Usage Lab researchers noticed that the services proposed in “Aloha!” had much more ambient intelligence than the ones produced in GenIoT. As a consequence, conversely to D4.3.1, the GenIoT exercise reported in the present document was run after the “Aloha!” game. Moreover, a main feedback was implemented as requested by the participants during the previous GenIoT experimentation: the possibility to receive an alert for each post on the collaborative platform. Furthermore, we organised a physical review of the posts at mid-experimentation in order to make the production more dynamic.

As already mentioned, the Ideastream tool was extended with new on-line idea generation functions compared to the one used in D4.3.1. Ideastream was also customised for the health and well-being topic.

5.2.1.2 Experimentation 2:

Experimentation 2 has been added in order to force participants to co-create a green watch. Indeed, as per the DoW, the green services must be based on green watches. During the co-creation workshop, participants tended to put the ambient intelligence that already exists on the green watch on many other supports other than a watch.

Experimentation 2 aims at reducing the gap and improving the convergence of the co-creation workshop and the green services provided by the portal via the watches (and citizen stations). It also provides an opportunity to test the diary method in relation with KSB assessment.

	ELLIOT – Experiential Living Lab for the Internet Of Things	Project N.	258666
	D4.3.2 – Report on IOT Living Labs Continuous Exploration and Evaluation (interim)	Date	31.08.2012

5.2.2 Data Collection Changes

Some data collection changes were carried out:

First, as mentioned previously, the customisation of Ideastream (used for D4.3.1) into “ideesanté” was improved offering new functionalities such as notification of idea and comments posts, introduction of favourite flags and modification of point and badge management. This customisation required follow-up changes in the data collection. The Ideastream log data collection was improved significantly in order to support all needed KPI computations, therefore avoiding the requirement of using web HTTP logs as necessary for the work reported on in D4.3.1.

Second, diary questionnaires were used during two weeks for Experimentation 2. The Sphinx component of the FocusLab was programmed to generate and email customised links to the participants.

Third, related to IoT data collection used for the implementation of green services (cf. Appendix 8.3) and for the future experiment with green services (phase 2), various changes for sensors and sensor data collection (see Appendix 8.4) were implemented:

- Green watches: LEDs alerting the watch wearer and four user interface buttons for user interaction and behaviour tracking are being implemented at the time of writing.
- Air PACA fixed stations: two Air PACA stations were added in Antibes in the list of fixed stations and sensor data was captured from files generated by Air PACA.
- EV-based sensors: air sensors were changed (O3-NO2-grouped instead of O3 and NO2 separately), which necessitated software changes on the EV-server-side to be carried out by VULOG and the green services server side to be carried out by INRIA. PM10 data availability is not guaranteed and under investigation.
- Pollux air/noise stations: due a higher price (due to a change of sensors), air stations that exclusively measure PM10 for air quality were ordered in place of the models that were originally planned to be purchased.

5.2.3 Data Analysis Changes

Instead of using Web logs in addition to the database of Ideastream as in D4.3.1, the “idea analytics” component of our customised Ideastream (part of FocusLab) was extended in order to integrate the computation of the relevant indicators/KPIs. IoT data analysis was worked on during this period in order to prepare the future experimentation with green services (see Appendix 8.3).

	ELLIOT – Experiential Living Lab for the Internet Of Things	Project N.	258666
	D4.3.2 – Report on IOT Living Labs Continuous Exploration and Evaluation (interim)	Date	31.08.2012

5.3 Participants

Experimentation 1: Participants in the professional group were invited on the basis of their occupation and interest in the topics of air quality and health. Full profiling of the professional group is described in Appendix 8.1.1. This GenIoT session was run with a total of 8 participants from ‘white collar’ professions with a good understanding of air quality issues and air quality measurement, involved in sustainable development and with a balanced viewpoint on the role of the Internet and technology.

Experimentation 2: Participants in the fake green watch experiment were volunteers recruited via the ICT Usage Lab network and were asked to fill in the online questionnaire (cf. Appendix 8.2) in order to create a composite group in terms of demographics, attitude towards ICT, usage of ICT, attitude towards sustainable development, and knowledge regarding air quality. However, 50% of the participants were concerned with health (1 asthmatic, 1 with a rare sickness, 1 nurse).

Experimentation 2 ran with a group of 6 citizens, full profiling is described in Appendix 8.1.2. Participation rate was 100%. Some participants preferred to answer the questionnaires on a paper version. This is the case of subject 6 who did fill in the forms daily but went on holiday forgetting to send them back to the ICT researchers. The analysis presented in this document therefore does not include the data from subject 6.

5.4 Data Collection

5.4.1 Sensor Data

For Experimentations 1 and 2, real sensor data was not collected but usage data for a ‘dummy’ (or ‘fake’) green watch that contained no IoT components was gathered in natural contexts. For phase 2, mainly for the next experimentations based on green services (implementation of the version v1 under development), various types of sensor data were collected. See Appendix 8.3 for more details on sensor data.

5.4.2 Observation and Survey Data

Experimentation 1: The Ideastream database (i.e. ideas names, ideas tags, idea categories as produced by the participants) forms the core of the collected data. Video recording was also used in co-creation workshops.



Table 32: Collected data for Experimentation 1

Category	Data source	Data ID	Value reported in D4.3.1	Value in experimentation 1	Collected Data
<i>Row data</i>	<i>IdeaStream data (data base)</i>	IL1	Figure 45	Table 36	Logged user
		IL2			User action (Idea posted, comment posted, picture posted, tag posted, idea vote,...)
		IL3			Time
		IL4			Date
<i>Qualified Data</i>	Elaborated data from IdeaStream data	IQ1	24	15 (10 different)	#pictures posted
		IQ2	35	54	#tags
		IQ3	N/A	N/A	graph of who-commented-what
		IQ4	1	0	#comments building on a previous remark
		IQ5	3	3	#shared-tags
		IQ6	1	0	#ideas with more than x% participants having commenting it (e.g. x= 40)
		IQ7	-	-	frequency of site visits
		IQ8	1	0	#comments
		IQ9	N/A	N/A	graph of communications
		IQ10	N/A	0	#dyads
		IQ11	N/A	0	#triads
		IQ12	8	8	#isolated participants
		IQ13	IDUser=1	/	most voted user
		IQ14	/	/	most voted idea
		IQ15	25	20	#ideas (globally)
		IQ16	Table 36	Table 37	#comments per user
		IQ17			#ideas per user
		IQ18	9	10	#fake sensors involved (globally)
		IQ19	Figure 6	Table 33	IoT category
		IQ20	N/A	N/A	average response lag time
	IQ21	N/A	N/A	average visit duration	
	Human Observation	O1	“happy”	thoughtful	facial expression while touching the fake sensors
O2		4	6	#questions asking for clarification	
O3		N/A	0	spontaneous posting of an idea in response of a problem statement	
Paper Log	PL1	0	0	#comments on the paper diary	
Question	Q1	variable	Not motivating	perception of the rewarding feature	

Table 33: Idea Category as identified by the participants (against a predefined list)

IoT Category (IQ19)	Nbr ideas
GENIOT inside	12
GENIOT outside	6
GENIOT hybrid	3

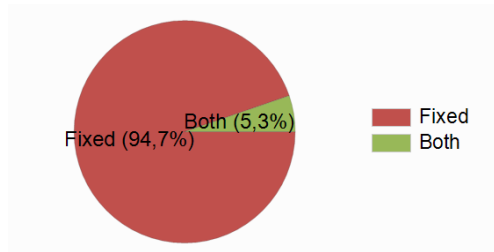

Figure 35: GenIoT services based on fixed or mobile sensors

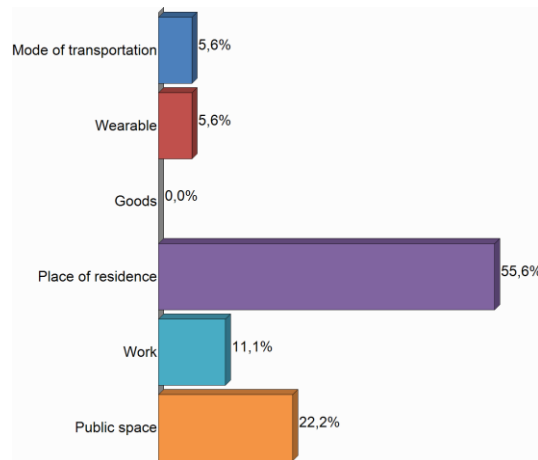

Figure 36: Location of the sensors in the GenIoT ideas produced

Experimentation 2

An English translation of the diary questionnaire is provided in Appendix 8.2. Questions have been numbered from GWQ1 to GWQ6. All indicators provided by the questions are coded as indicated below in Table 34.

	ELLIOT – Experiential Living Lab for the Internet Of Things	Project N.	258666
	D4.3.2 – Report on IOT Living Labs Continuous Exploration and Evaluation (interim)	Date	31.08.2012

Table 34: Collected data for Experimentation 2

Name of questionnaire section	Name of the indicator	Explanation of the indicator
GWQ1	GWQ1.1	#internal consultation of the watch
GWQ1	GWQ1.2	#external consultation of the watch
GWQ1	GWQ1.3	#consultation of the watch in transportation mean
GWQ2	GWQ2.1	Consultation of overall air index (binary indicator)
GWQ2	GWQ2.2	Consultation of O3 sensor (binary indicator)
GWQ2	GWQ2.3	Consultation of NO2 (binary indicator)
GWQ2	GWQ2.4	Consultation of Pollen sensor (binary indicator)
GWQ2	GWQ2.5	Consultation of CO2 (binary indicator)
GWQ2	GWQ2.6	Consultation of noise sensor (binary indicator)
GWQ2	GWQ2.7	Consultation of humidity sensor (binary indicator)
GWQ2	GWQ2.8	Consultation of temperature sensor (binary indicator)
GWQ2	GWQ2.9	Consultation of next bus real time information (binary indicator)
GWQ2	GWQ2.10	Consultation of another sensor (binary indicator + name of the extra information)



Name of questionnaire section	Name of the indicator	Explanation of the indicator
GWQ3	GWQ3.1 to GWQ3.25	Activity reporting from a predefined list (binary indicator + name of the extra activity if needed)
GWQ4	GWQ4.1	Itinerary change (binary indicator)
GWQ4	GWQ4.2	Communication of the sensor information to a third party (binary indicator)
GWQ4	GWQ4.3	Rescheduling of the current activity (binary indicator)
GWQ4	GWQ4.4	Change in transportation modality (binary indicator)
GWQ4	GWQ4.5	Reshuffling of personal planning (binary indicator)
GWQ4	GWQ4.6	Medicine intake (binary indicator)
GWQ4	GWQ4.7	No change (binary indicator)
GWQ4	GWQ4.8	Consultation only (binary indicator)
GWQ4	GWQ4.9	Other change (binary indicator + textual information)
GWQ5	GWQ5.1	Communication to social network (binary indicator)
GWQ6	GWQ6.1 to 7	Identification of the member of the social network (binary indicator)
GWQ7	GWQ7.1	
GWQ7	GWQ7.2	Expression of doubt on the concept of the green watch services (binary indicator)
GWQ7	GWQ7.3	Expression of surprise on the

Name of questionnaire section	Name of the indicator	Explanation of the indicator
		concept of the green watch services (binary indicator)
GWQ7	GWQ7.4	Expression of interest on the concept of the green watch services (binary indicator)
GWQ7	GWQ7.5	Expression of resistance to the concept of the green watch services (binary indicator)
GWQ7	GWQ7.6	Expression of amusement about the concept of the green watch services (binary indicator)
GWQ7	GWQ7.7	Expression of lack of interest on the concept of the green watch services (binary indicator)

5.5 Data Pre-processing and Data Analysis

5.5.1 Sensor Data Analysis

Related to IoT data analysis, some basic pre-processed data is used to identify the different risk intervals of values (corresponding to various colours). Colours for measures are intended to be used when generating pollution maps on the green services interface. This preliminary analysis is also used for alert identification.

5.5.2 Observation and Questionnaire Data Analysis

Experimentation 1: Similarly to D4.3.1, various indicators/KPIs are computed by the extended *idea analytics* component of our Ideastream tool (involved in FocusLab platform) as summarised in Table 35 and Table 36.

Table 35: On-line Idea generation activities by participants (Experimentation 1)

IDUser	#Points	#Ideas/user (IQ17) and Total (IQ15)	#Posted Pictures IQ1	#Tags IQ2	#Comments IQ8
35	22	3	3	0	0
36	4	0	0	0	0
37	0	0	0	0	0

	ELLIOT – Experiential Living Lab for the Internet Of Things	Project N.	258666
	D4.3.2 – Report on IOT Living Labs Continuous Exploration and Evaluation (interim)	Date	31.08.2012

IDUser	#Points	#Ideas/user (IQ17) and Total (IQ15)	#Posted Pictures		#Comments IQ8
			IQ1	IQ2	
38	0	0	0	0	0
39	49	7	5	25	0
40	0	0	0	0	0
41	10	1	0	3	0
42	0	0	0	0	0
43	7	1	1	2	0
44	36	5	1	14	0
45	0	0	0	0	0
46	18	3	0	10	0
Total	146	20	10	54	0

Table 36: On-line Idea generation User Visits (Experimentation 1)

IDUser	#Visits	#Clicks	DateStart	DateEnd
35	8	68	2012-06-27 12:22:20	2012-07-09 13:48:48
36	4	65	2012-06-26 18:41:42	2012-07-05 16:40:15
37	3	7	2012-06-29 09:03:12	2012-06-29 15:16:08
38	1	2	2012-06-29 15:18:00	2012-06-29 15:18:01
39	7	213	2012-07-03 09:26:07	2012-07-09 13:48:36
40	3	10	2012-07-04 23:33:11	2012-07-04 23:37:27
41	5	31	2012-06-27 09:38:12	2012-07-09 10:26:43
42	1	2	2012-06-29 15:18:29	2012-06-29 15:18:29
43	4	46	2012-06-26 18:38:26	2012-07-03 08:30:55
44	8	89	2012-06-28 14:18:03	2012-07-09 13:48:16
45	1	2	2012-06-29 16:44:36	2012-06-29 16:44:36
46	2	49	2012-07-09 10:27:04	2012-07-09 10:35:40
Total	47	584	2012-06-27 12:22:20	2012-07-09 13:48:48

On-line engagement does not reflect the overall engagement of most of the participants of the

	ELLIOT – Experiential Living Lab for the Internet Of Things	Project N.	258666
	D4.3.2 – Report on IOT Living Labs Continuous Exploration and Evaluation (interim)	Date	31.08.2012

group. Indeed, most participants reported that they did not take time to connect and/browse through the platform.

Log observation also shows that, even when they read about an idea, they would not click on the image thumbnail illustrating the idea. Six out of the ten participants made visits (1 to 3) only during the same day, and only 4 visited *ideasanté* on different days and their number of visits was between 4 and 8. Most of them explained that participation in the experimentation was done as an extra task during their working hours and that they would not take the time for the online activity. However, they did try and play the game for the GenIoT exercise as this was often taken during their free time. A core number of participants asked for a third workshop (which was not initially in the plan due to concerns of demanding too much from the participants) in order to go on further and offer to test the intelligent green service in live situations even as a prototype version as it was produced by the group.

Comments on the face-to-face workshops prior and during the GenIoT experimentation

Some group participants were initially very reticent about centralising the information from the sensors in a smartphone and were even reluctant to admit to personally owning one. Most of them did change their mind during the workshop and one even declared that she was about to buy a smartphone in order to use the health and IoT applications they discovered.

It is interesting to notice that, while the participants in this group tended to use more sensors in a very dedicated way articulating more elaborate services,

- 1) they tend not to go for a high level of automation (actuators would stay at the level of the screen or better, shape of colour change) in order to respect “individual freedom”,
- 2) and they tend to try and simplify the service while specifying it, in order to ensure a better user experience and ensure better marketing. This willingness to ensure a good user experience and easy handling of a couple of “intelligent objects” produced by the group may have been induced by the usage of play dough in order to 3D model the object and reproduce the requirements for a Bluetooth or RFID connection from a user viewpoint.

5.5.3 Data-KSB Mapping

5.5.3.1 Experimentation 1 (on-line idea generation)

Data-KSB mapping is similar to that used in D4.3.1. KSB values are summarised in Table 37 and their computation is explained in 5.6.2

Table 37: Data-KSB mapping for Experimentation 1

	Ref	Properties	Input	Involved Indicators	Value
Knowledge	K2.4	Conation (Desire)	observation	O1	medium
	K5.1	Self-examination	paper log, Ideastream database	LP1, O1, IQ1	Low
	K6.1	Team cognitive process	Ideastream database	IQ2, IQ3	Low
	K7.2	Shared meanings	Ideastream database	O2, IQ4, IQ5	Low
	K7.4	Group consciousness	Ideastream database	IQ6	Low
Social	S1.1	Social Networking	Ideastream database	IQ20, IQ7, IQ8	low
	S2.1	Communication	Ideastream database	IQ9, IQ10, IQ11, IQ12	low
	S3.2	Influential behaviour	Ideastream database	IQ13, IQ14	low
	S4.3	Rewarding	Debriefing	Q1	medium
	S7.1	Attractiveness	Ideastream database and observation	IQ21, IQ7, IQ8, IQ15, IQ16, IQ17	medium
	S11.1	Caring	observation	O3	low

5.5.3.2 Experimentation 2 (fake green watch)

The fake watch experiment prepares for the real watch experiment in the sense that it both provides information about the places and activities and the stimuli triggering the consultation of the watch (therefore about situated cognition) and also provides data about the usefulness of the green watch. Such data may not be as valid as that of a ‘real’ green watch experiment, but it allows a first iteration in the effort of building rules for mapping data and KSB properties.

In the fake green watch experiment, the number of watch consultations as well as the type of data read is obtained via a daily questionnaire, while in the real watch experimentation such data will come directly from the watch.

KSB properties in bold are considered as more important than normal ones, hence the target values indicated in the table below.

Table 38: Data-KSB mapping for Experimentation 2

	Ref	Properties	input	Involved indicators	Target Value
Knowledge	K7.1	Situated Cognition	Questionnaire, debriefing	GWQ3.*	High
Social	S7.2	Perceived Appealingness	Questionnaire, debriefing	GWQ5.*,GWQ7.*	Medium
Business	B.1.5	Ambient Intelligence	Questionnaire, debriefing	GWQ2.*,GWQ1.*	Medium
	B4.1	Usefulness	Questionnaire, debriefing	GWQ1.*,GWQ4.*	High

Note: GWQi.* relates to all indicators derived from GWQi section.

KSB rules use the data elaborated from the diary study and involve thresholds that are set after exploration of the data (manual data clustering). Such thresholds are named α , β and γ but take different values depending on the rule they refer to.

All rules allow measuring KSB properties per users: all rules are based on *hypothetical* relationships between the indicators and are therefore *not reliable*. More research should be performed in order to build reliable rules. However, they are written and used in order to test the ELLIOT approach to measure user experience –as per Green services use case mission.

In this document, these rules are also used to measure the overall service experience. However, individual KSB profiles are summarised (in case of wider samples, pattern analysis may be relevant in future experiments) in Table 40.

5.5.3.3 B4.1 Usefulness Rule

Usefulness is calculated first by considering the rate of watch consultation then by weighting the rate according to the behaviour change. The assumption is that the watch is useful if it is used and that it is more useful it leads to at least γ changes of behaviour.

	ELLIOT – Experiential Living Lab for the Internet Of Things	Project N.	258666
	D4.3.2 – Report on IOT Living Labs Continuous Exploration and Evaluation (interim)	Date	31.08.2012

First step:

If average (\sum (GWQ1.1, GWQ1.2, GWQ1.3) per user) $\geq \alpha$

Then usefulness = high

If $\alpha < \text{average} (\sum (\text{GWQ1.1, GWQ1.2, GWQ1.3}) \text{ per user}) < \beta$

Then usefulness = medium

If $\alpha < \text{average} (\sum (\text{GWQ1.1, GWQ1.2, GWQ1.3}) \text{ per user}) < \beta$

Then usefulness = low

Second step:

#behaviourchange = \sum (GWQ4.1, GWQ4.3, GWQ4.4, GWQ4.5, GWQ4.6, GWQ4.9)

If average (#behaviourchange per user) $\geq \gamma$

Then increase (usefulness)

5.5.3.4 B1.5 Ambient Intelligence Rule

The rule used for assessing ambient intelligence is a function of #sensors quoted at least once: it is therefore a function of GWQ2.i.

If average (number of sensors quoted at least once per user) $< \alpha$

then B1.5 is low

If $\alpha \leq \text{average} (\text{number of sensors quoted at least once per user}) < \beta$

then B1.5 is medium

If average (number of sensors quoted at least once per user) $\geq \alpha$

then B1.5 is high

5.5.3.5 S7.2 Perceived Appealingness

Perceived appealingness is qualified by predefined adjectives given in the online diary. These adjectives depict the perceived appealingness from the viewpoint of a person newly introduced to the green watch as a concept - but based on the physical handling of the fake watch.

Adjectives are a priori regrouped in terms of positive (“interested”, “amused”), neutral (“doubtful”, “surprised”) and negative (“not interested”, “resistant”) opinion of the watch. The biggest set of occurrences of adjectives determines the overall evaluation of S7.2.

	ELLIOT – Experiential Living Lab for the Internet Of Things	Project N.	258666
	D4.3.2 – Report on IOT Living Labs Continuous Exploration and Evaluation (interim)	Date	31.08.2012

This clustering of the adjectives is an initial attempt to provide a simple rule for measuring S7.2; by definition it might overestimate the appealingness (doubtful could as well been put in the negative set).

$$x = \sum (\text{GWQ7.5}, \text{GWQ7.7})$$

$$y = \sum (\text{GWQ7.2}, \text{GWQ7.3})$$

$$z = \sum (\text{GWQ7.4}, \text{GWQ7.4})$$

If $\max(x, y, z) = x$

then S7.2 = low

If $\max(x, y, z) = y$

then S7.2 = medium

If $\max(x, y, z) = z$

then S7.2= high

5.5.3.6 K7.1 Situated Cognition

Situated cognition is approximated by the variety of contexts triggering the consultation of the watch. Therefore there is a function of the number of contexts quoted at least once per user, called c.

$$c = \sum (\text{GWQ3.i} = 1) \text{ with } i=1 \text{ to } 25$$

If average (c per user) $< \alpha$

then K7.1 is low

If $\alpha \leq \text{average (c per user)} < \beta$

then K7.1 is medium

If average (c per user) $\geq \beta$

then K7.1 is high

Please note that all “K” KSB elements are difficult to assess only via objective metrics and all KSB rules are subject to modification according to the qualitative data obtained from the individual debriefings and further research.

	ELLIOT – Experiential Living Lab for the Internet Of Things	Project N.	258666
	D4.3.2 – Report on IOT Living Labs Continuous Exploration and Evaluation (interim)	Date	31.08.2012

5.5.4 Usage of ELLIOT Data Analysis Features (experimentation 2)

Data analysis is carried out via the Sphinx component of the FocusLab part of ELLIOT. The automatic data analysis involves simple statistical analysis.

5.6 Results and Inferences

5.6.1 Experiment Outcomes

5.6.1.1 Experimentation 1

We report here the interpretation of the above data from the content analysis viewpoint and compare it to the previous GenIoT exercise (reported in D4.3.1).

Volume and categories of the GenIoT ideas were similar to the mobility exercise: internal applications (Table 33), specifically home-based services, are more popular (cf. Figure 36). The reason expressed by the participants was the same as the one inferred from the protocol analysis of the citizen workshop: people feel more in control and possibly active when internal air quality is concerned, while they just have to adapt their physical exercise or itinerary (or in some case, take medicine) in the case of poor quality external air.

However, this group felt more comfortable mixing both external and internal scenes when developing a green service for a young girl suffering from asthma (‘Aloha!’ method so not reported extensively in this document). Moreover, the nature of sensors used in the GenIoT services was different from the previous run, as sensors were more targeted (usage of CO2 complemented by humidity and temperature for internal air for instance in the case of a meeting room) and tend to include chemical pollutant as well as germs and bacteria.

Sensors were most of the time seen as fixed ones (Figure 35), hidden in nice and appealing objects, providing an alerting service that would come directly from the intelligent object (and not the smartphone – this was stressed several times). Moreover, the intelligent watch was not considered as an attractive intelligent object and participants tended to go for more expressive objects and highlighted the change of shape or colour as a more acceptable way to communicate the air-related information.

In this group, the level of knowledge on air quality and the definition of air pollution was higher than in the citizen group and the group naturally agreed on considering as potential green services all the services that would detect and cover any subjective “bad smell”, which led to the identification of new services diffusing aromas (therefore potentially covering up the air pollution).

5.6.1.2 Experimentation 2

Time series show that all participants contributed daily in the reporting exercise during the whole period of the study (from 13th to the 23rd of July), some of them even went on filling the online questionnaire while they were not receiving any reminder (as shown in Figure 37).

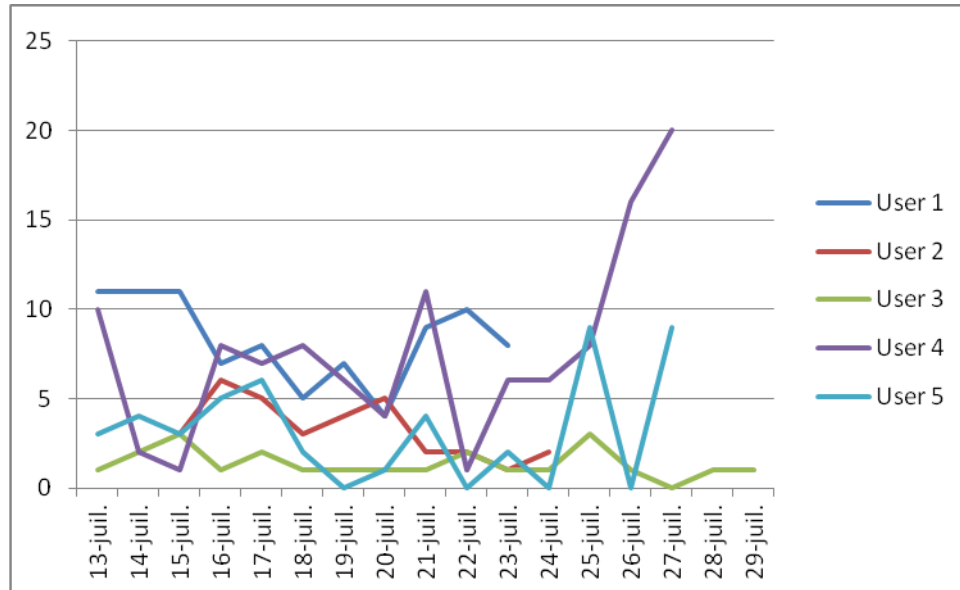

Figure 37 : Fake watch consultations (Σ (GWQ1.1, GWQ1.2, GWQ1.3)) per user per day

We opted to include these extra answers in the data set as the main objective of the study is to collect information about watch daily consultations (sensors, contexts, activities).

As developed below, the overall KSB evaluation of the green watch service via the fake green watch experiment are as reported in Table 39.

Table 39: Results of experiment 2: KSB evaluation of the green watch service

KSB property	Value	Target Value
B4.1 Usefulness	Medium	High
B1.5 Ambient Intelligence	Medium	Medium
S7.2 Perceived appealingness	Medium	Medium
K7.1 Situated cognition	Medium	High

Table 40: Individual KSB evaluation

KSB property	User 1	User 2	User 3	User 4	User 5
B4.1 Usefulness	High	Medium	Low	High	Low
B1.5 Ambient Intelligence	High	High	Medium	Medium	Medium
S7.2 Perceived appealingness	Medium	Low	High	Medium	High
K7.1 Situated cognition	High	High	Medium	Low	Medium

Individual evaluations are reported here and show that the overall assessment of the green service is similar for user 3 and 5. However, it is interesting to note that the pattern analysis of the qualitative information obtained during the debriefings would rather tend to group user 1 and 2 together. As the sample of users is very limited, no final conclusions can be drawn from this; however it prepares the ground for further experimentation that could go up to the identification of user persona.

5.6.2 KSB Analysis

5.6.2.1 Experimentation 1

Here, we report here the interpretation of the data from the KSB guided user experience analysis related to the participation to the online GenIoT exercise reported on above.

5.6.2.1.1 K2.4 Conation: Medium.

Please note that this data refers to the embodied cognition facilitated by the feeling of seeing, touching and placing the magnetic fake sensors. Most of the participants did touch and play with the props sensors during the GenIoT introduction and reported that they started to think about where and when they were going to place them. Most of them showed thoughtful and surprised faces. During the debriefing, they did not spontaneously mention the cubes as a powerful cognitive artifact. However, cubes did play a role in materialising the measure as they were used. As a conclusion the conation related to the handling of the fake sensors is interpreted as medium (on a scale of low/medium/high).

5.6.2.1.2 K5.1 Self-examination: Low.

As for the previous run, nobody filled in the paper diary in (PL=0), this data source cannot be

	ELLIOT – Experiential Living Lab for the Internet Of Things	Project N.	258666
	D4.3.2 – Report on IOT Living Labs Continuous Exploration and Evaluation (interim)	Date	31.08.2012

used within the current data set. As a consequence, the total number of times where participants did think of the challenge cannot be traced accurately and the hypothesis, against which the total number of ideas (IQ1 + PL1) is directly and positively correlated to the level self-examination, cannot be posed. This is reinforced by the fact that participants of this group had a globally good knowledge of air quality and were familiar with sensing (if not IoT). This is why we do not have any supporting information for scoring self-examination higher than low.

5.6.2.1.3 *K6.1 Team cognitive process (on line): low*

IQ2 is low on a scale of low/medium/high. For IQ3, the graph of overall communications shows that no team cognitive process happened online. K6.1 is therefore low on a scale of low/medium/high.

5.6.2.1.4 *K7.2 Shared meanings: low*

Bacteria, alert and pollution are the only three shared tags and are only shared by 2 participants at a time, leading to the assessment of ‘shared meanings’ as low.

5.6.2.1.5 *K7.4 Group consciousness: low*

As there was virtually no online group interaction, group consciousness is low, as per definition of WP1 for group consciousness. This is somewhat surprising as the group did run the Aloha! method and did exhibit group spirit and consciousness during the face-to-face workshops.

5.6.2.1.6 *S1.1 Social Networking: low*

Due to the very weak online group activity, indicators identified in D4.2.1 are either not applicable (IQ20) or very low (IQ7 and IQ8). As a consequence, the rule for qualifying online social networking cannot be further elicited or tested. However, the interpreted value of (online) social networking is clearly low.

5.6.2.1.7 *S1.2 (Online) Communication: low*

No online communication occurred between participants: no comment was posted and only one idea was voted on, so that (online) communication was scored as low.

5.6.2.1.8 *S3.2 Influential behaviour: N.A*

As exemplified above, IQ13 and IQ14 are clearly not good indicators of influential behaviour in this case. This indicator is therefore deemed not applicable.

	ELLIOT – Experiential Living Lab for the Internet Of Things	Project N.	258666
	D4.3.2 – Report on IOT Living Labs Continuous Exploration and Evaluation (interim)	Date	31.08.2012

5.6.2.1.9 *S4.3 Rewarding: low*

All participants were aware of the gamification rules (or at least that they would gain points when connecting and providing content to the group). Participants did show an interest in being rewarded but being rewarded in points only was not seen as a significant motivational factor for increasing their participation.

5.6.2.1.10 *S7.1 Attractiveness: low*

Indicators involved in the measurement of the level of attractiveness involve on one hand the attractiveness related to the experience of the online tool, which is related to average visit duration (IQ21), frequency of visit (IQ7), number of comments (IQ8) and is low, and on the other hand the attractiveness of the GenIoT method which required the use of the online tool, which is higher since IQ15, IQ16 and IQ17 (number of ideas globally and per user, comments) are higher. Global attractiveness of the whole online GenIoT process can therefore be qualified as medium.

5.6.2.1.11 *S11.1 Caring: low*

As there was neither group consciousness nor social network or communication, caring can be interpreted as low.

Please note that these indicators are related to the online dynamic that was virtually nonexistent but they do not apply to the face-to-face group interactions which were video recorded.

5.6.2.1.12 Impact of the insertion of the Aloha! feedback within the GenIoT on-line production

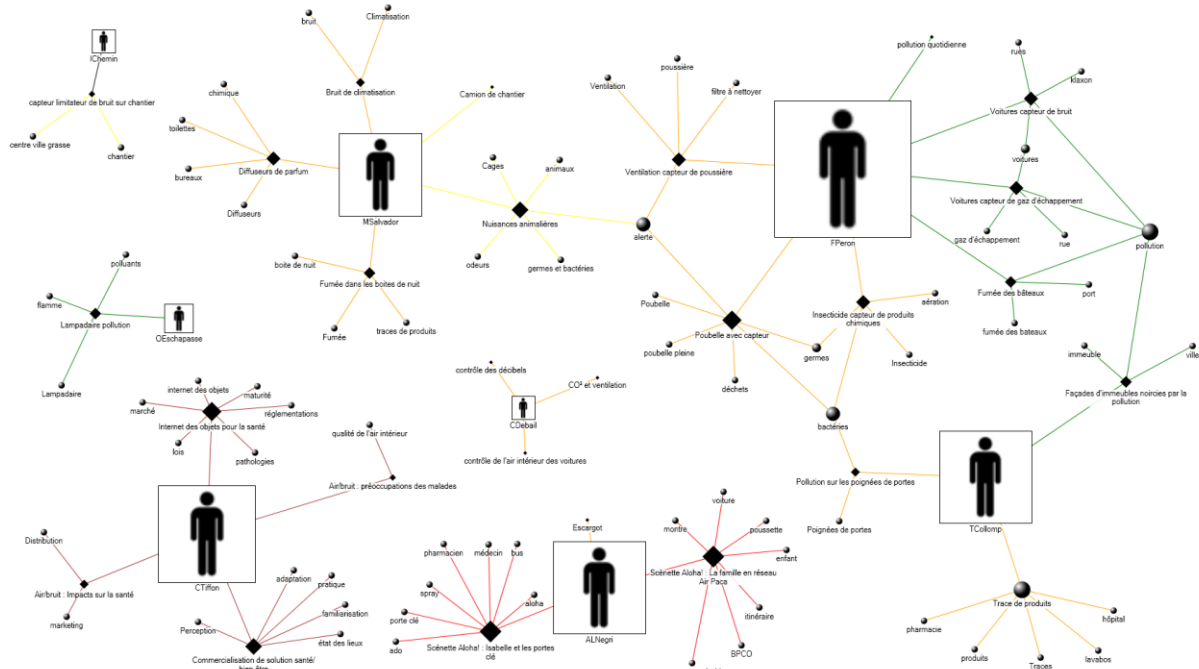

Figure 38 : Ideas (losanges) and tags (dots) elaborated for and from GenIoT

In Figure 38, Aloha! ideas as well as generic discussions are represented in red and brown graphs respectively, while ‘GenIoT inside’ ideas are orange and ‘GenIoT outside’ ideas are green. Tags used for the ideas were not taken up by the other users. Moreover Aloha! ideas were not commented on online (while they were very popular during the face-to-face meetings).

Considering the impact of running Aloha! before GenIoT, it is difficult to conclude on whether or not the order of the method increases the ambient intelligence (approximated as the variety in sensors and number of actuators).

5.6.2.2 Experimentation 2

5.6.2.2.1 B4.1 Usefulness: medium

Table 41: Relevant data per user for assessing the usefulness of the green watch

User Id	Average GWQ1.1	Average GWQ1.2	Average GWQ1.3	Total	#behaviour change	Declaration of Perceived usefulness
1	2.24 (2.05)	2.2(1.8)	1.17 (1.22)	4.53(4.05)	N.A.	Very useful (4)
2	1.70(0.78)	1.62(0.69)	1.50(0.5)	3.3(1.5)	N.A.	Rather useful (3)
3	1 (0)	1.36(0.48)	1(0)	1.23(0.65)	N.A.	Rather useful (3)
4	2.9(2.56)	3.26(2.79)	1.40(1.66)	7.6(5.04)	N.A.	Very useful (4)
5	0.64(0.89)	1.86(1.49)	0.73(0.92)	3.2(2.92)	N.A.	Rather useful (3)
Total	2.24(2.05)	2.20(1.84)	1.18(1.22)	4.53(4.05)	N.A.	N.A.

Although, the volume of data is very limited, the hypothesis of a link between the perceived usefulness and the total average number of consultations of the watch appears valid and cannot be rejected given the gathered data.

However, the thresholds for establishing the usefulness scale seem to be lower than what was initially intuitively expected. From the quantitative data, 3 main clusters can be separated, with $\alpha = 1.5$ and $\beta = 2.5$.

Moreover, while one participant did report on changes made due to the fake watch, most of them explained that, even if they could mentally project themselves and the potential change they would do (or not) – the fake watch fully fills its role as a cognitive artefact -, not having the real data did not trigger a change in terms of behavioural change. Awareness of the air quality was pointed out as much increased after the experimentation (K4.7, cognitive artefact is high from the analysis of the interviews). All participants did volunteer for hosting the real sensors which confirms the perceived usefulness of the citizen sensors. However, most of them would rather host a fixed station mainly for aesthetical reasons and for not taking the risk of breaking the real watch (which is anticipated to be expensive by the participants).

	ELLIOT – Experiential Living Lab for the Internet Of Things	Project N.	258666
	D4.3.2 – Report on IOT Living Labs Continuous Exploration and Evaluation (interim)	Date	31.08.2012

This perception of the mobile IoT device as needing physical protection (and therefore not adapted in external and sportive settings) echoes similar concerns developed by the participants of the health/well being group who insisted that the IoT device should be both very solid and aesthetic.

As a consequence, the second part of the rule for calculating B4.1 could not be tested in the fake green watch experiment but the hypothesis linking changes in behaviour to the usage of the watch remains valid as it was not weakened during the interviews with the participants. However, it was very clear that participants who value the watch as an element of change also take for granted that it not only provides measurements but also qualifies the measurements (by placing them within boundaries), provides information about the sources of the pollutants and most of all provides recommendations on alternative behaviour.

The usefulness therefore covers the whole green service provided via both the watch and the GS portal and/or smartphone application.

As shown in the table below, the calculated individual values for KSB B4.1 usefulness match the perceived usefulness mainly for the very interested participants (1 and 4). For two others, the calculated usefulness is moderated to a lower value, which is as well in line with the interview.

Table 42: Calculated individual values for KSB B4.1 (Usefulness)

User Id	Average consultations	B4.1 Usefulness
1	4.53(4.05)	High
2	3.3(1.5)	Medium
3	1.23 (0.65)	Low
4	7.6(5.04)	High
5	3.2(2.92)	Low
Total	4.53(4.05)	Medium

When calculated as an average value, overall usefulness of the watch as a green service, B4.1 is medium.

Qualitative data also gives information about the usage of the watch: most of the participants

	ELLIOT – Experiential Living Lab for the Internet Of Things	Project N.	258666
	D4.3.2 – Report on IOT Living Labs Continuous Exploration and Evaluation (interim)	Date	31.08.2012

would use it as a complement to their physiological sensors. Indeed, participants are interested in comparing the objective measure given by the watch with their perception of the context. Another type of comparison involves most frequented places: participants are interested in being able to compare the environmental data in the places they regularly visit, mostly in order to identify a best time for the visit or at least to “be aware of the state of the environment”. Modification of the itineraries and personal planning are only weakly quoted as potential consequences of the watch consultation.

5.6.2.2.2 *B1.5 Ambient Intelligence: medium*

As for the GenIoT and Aloha! experiments reported on in D4.3.1 and above, ambient intelligence is approximated by the variety of sensors consulted by the participants during the experiment and could also be refined by the expectations in terms of actuators. Expectations in terms of actions performed or triggered by the watch were assessed via the interview while the number and type of sensors consulted can be derived from the online diary data.

The rule used for assessing ambient intelligence is a function of #sensors quoted at least once.

If average number of sensors quoted at least once per user $< \alpha$

then B1.5 is low

If $\alpha \leq$ average number of sensors quoted at least once per user $< \beta$

then B1.5 is medium

If average number of sensors quoted at least once per user $\geq \beta$

then B1.5 is high

After a basic cluster analysis, thresholds values are: $\alpha=3$ and $\beta=9$.

9 types of sensed data were proposed. Many participants did add more information to be shown by the watch (hence some answers being above 9).

The average number of sensors consulted per day is reported as well in Table 43 in order to qualify the ambient intelligence (#sensors quoted at least once= $f(\text{GWQ2.i})$).

Table 43: Average number of sensors consulted per day

User Id	#sensors quoted at least once	B1.5 Ambient intelligence	Average number of sensors consulted per day
1	10	High	7.45 (1.23)
2	12	High	4.7 (2.6)
3	8	Medium	3.35 (0.58)
4	7	Medium	3.2 (1.5)
5	7	Medium	3.45 (1.15)
Total	8.8 (1.25)	Medium	4.17(2.03)

This data – coupled with the qualitative interviews - allowed the identification of two profiles in terms of the vision of the ambient intelligence provided by the watch and more globally by the green services:

- **The environmental analysts:** this profile seeks to maximise the number and type of sensors in order to gather as much data as possible. The objective is to be able to compare measurements, provide complex analysis. Participants 1 and 2 could be placed in this category as they spontaneously talked about using the watch for comparing places and carrying out deep analysis, using potentially a wide spectrum of sensors in order to get a holistic view of the environment.

It is interesting to note that participants 1 and 2 correspond to respectively a sustainable development practitioner and a person with severe pathology connected with the environment.

- **The quick diagnostic lurkers:** this profile seeks punctual and interpreted information related to the current place. In this case the overall index is fine and sensors may be combined in order to show an aggregated value to the user.

The limited set of data does not make it possible to divide these categories further; however, qualitative data indicated that another dimension relevant for understanding the perceived ambient intelligence and more generally the overall UX of the IoT service is the expected

	ELLIOT – Experiential Living Lab for the Internet Of Things	Project N.	258666
	D4.3.2 – Report on IOT Living Labs Continuous Exploration and Evaluation (interim)	Date	31.08.2012

reliability (B element) of the sensors. Participants: user 3 and 4 who made both personal and professional use of the watch expected reliable and precise measurements (mainly for the professional usage) while other participants were much less concerned about the precision of the measures. Daily individual sensor consultations are reported from Figure 39 to Figure 43.

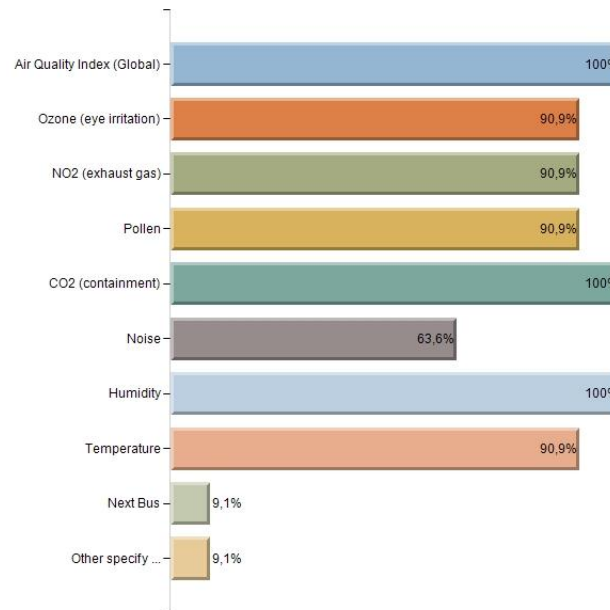

Figure 39: Sensors daily consultations User 1 (above)

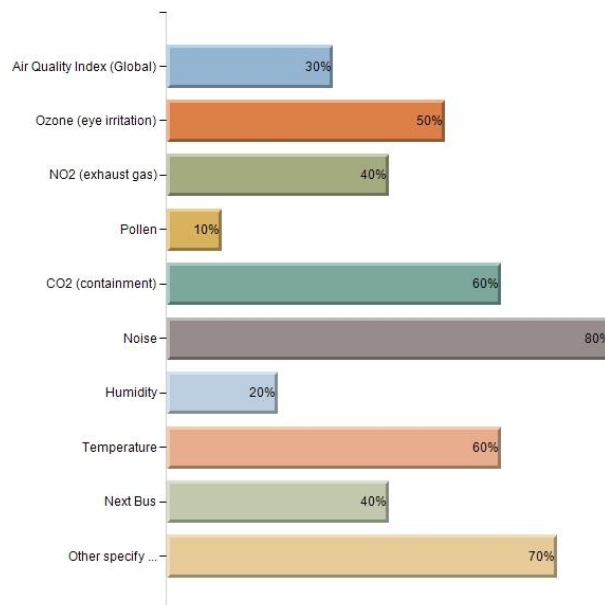

Figure 40: Sensors daily consultations User 2 (above)

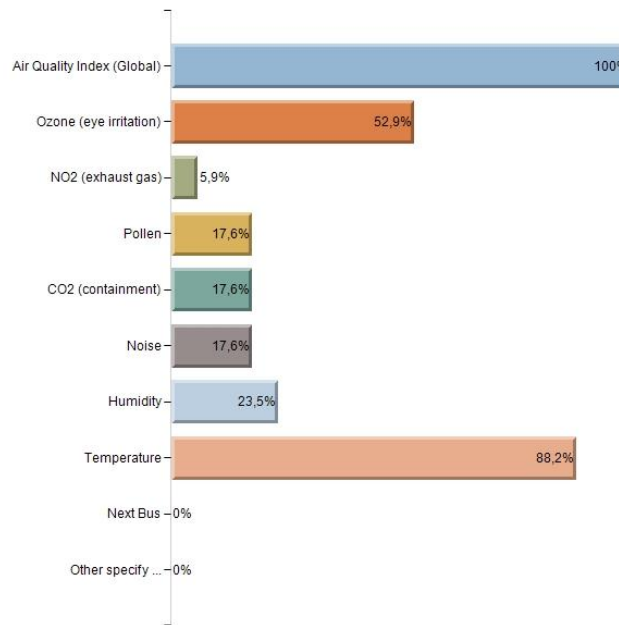

Figure 41: Sensors daily consultations User 3 (above)

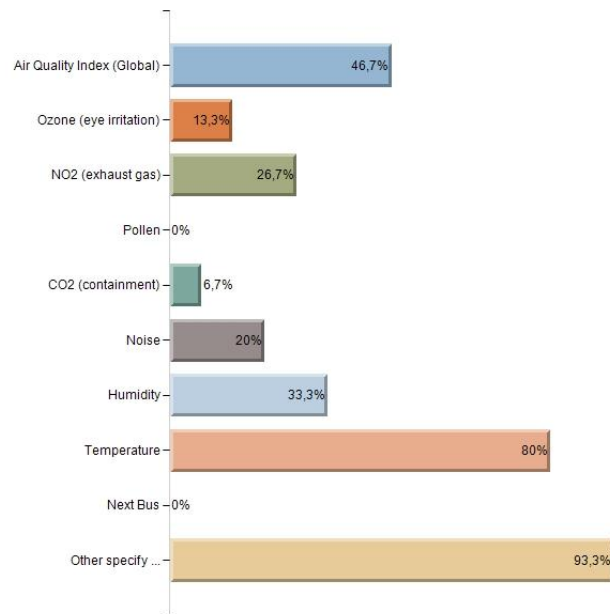



Figure 42: Sensors daily consultations User 4 (above)

	ELLIOT – Experiential Living Lab for the Internet Of Things	Project N.	258666
	D4.3.2 – Report on IOT Living Labs Continuous Exploration and Evaluation (interim)	Date	31.08.2012

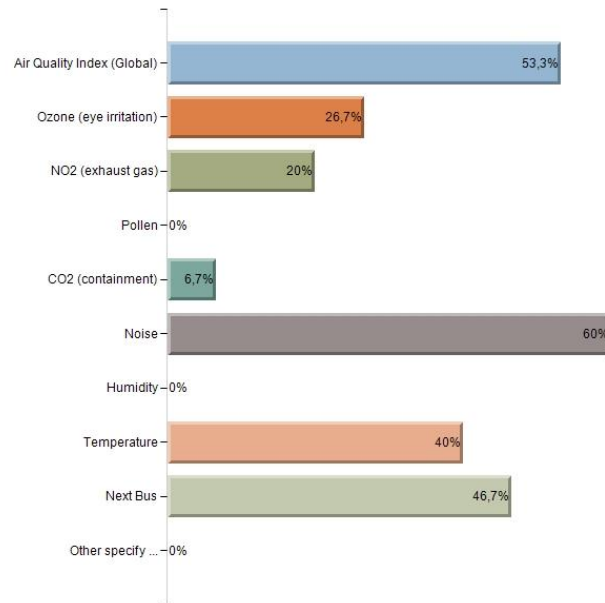

Figure 43: Sensors daily consultations Subject 5 (above)

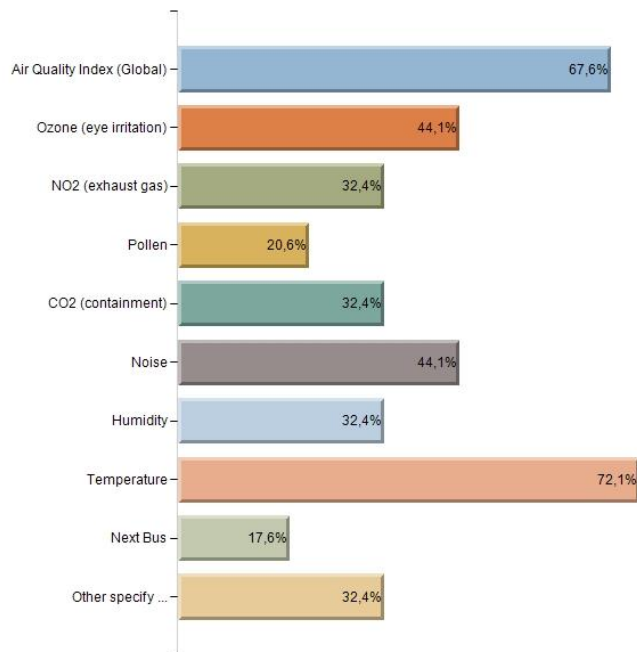



Figure 44: Total repartition of sensors daily consultations

Missing sensors were related to the use of air conditioning (participants would not know how to identify the sensors but were looking for information on not only humidity but also germs/bacteria), type of light (mainly in the case of artificial light) and time. The usage of the temperature sensor can be explained by the weather in the different sessions.

	ELLIOT – Experiential Living Lab for the Internet Of Things	Project N.	258666
	D4.3.2 – Report on IOT Living Labs Continuous Exploration and Evaluation (interim)	Date	31.08.2012

Please note as well that the experiment was run during an air pollution period (O3 pollution occurring in summer) just before the official measurements were taken (public information in the main streets, recommendation for driving slower, etc) so the communication campaign did not interfere with the experiment and participants were in the best situation to test the concept of the green watch.

5.6.2.2.3 S7.2 Perceived appealingness: Medium

Perceived appealingness refers to the attraction of the fake green watch as a concept explained by the participants to their social network.

Although the physical appearance of the fake watch was noticed on most participants, the overall rate of people being introduced to the concept is rather low (26% corresponds to around one person every 4 days per participant).

Moreover, as the duration of the experiment was rather short, many participants explained that they did not meet many people and did have many opportunities to show the green watch to others.

The rule for qualifying the perceived appealingness considers both the positive, negative or neutral statements about the watch as reported in the online dairy; many parameters could also be introduced in creating an interval of confidence in the final value (size of the population being introduced to the watch, influence of the participant both in presenting the concept and reporting the value etc).

Adjectives used by the circle of friend or family of the participants are reported in Table 44.

Table 44: Distribution of the reactions to the green watch concept by UserId

User Id	Not interested	Resistant	Doubtful	Surprised	Amused	Interested	Total
1				2			2
2	3						3
3			1	1	2	1	5
4			2			1	3
5		1	2	2	3		8
Total	3	1	5	5	5	2	21

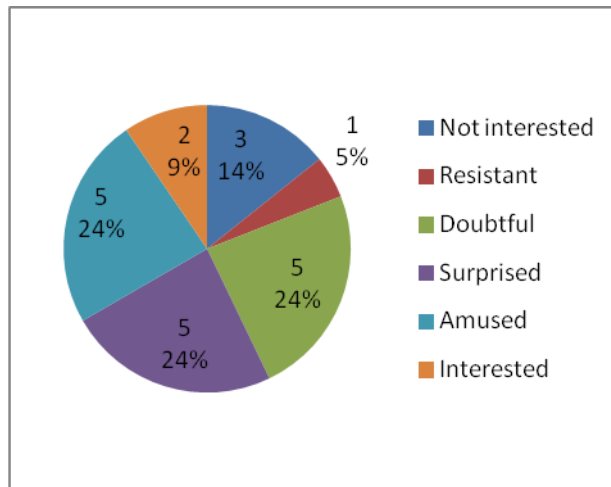

Figure 45 : Reaction to the presentation of the green watch concept by the participants

After the clustered against the rule described above, the overall evaluation of S7.2 is ‘medium’ as the greater set of answers are related to neutral evaluations.

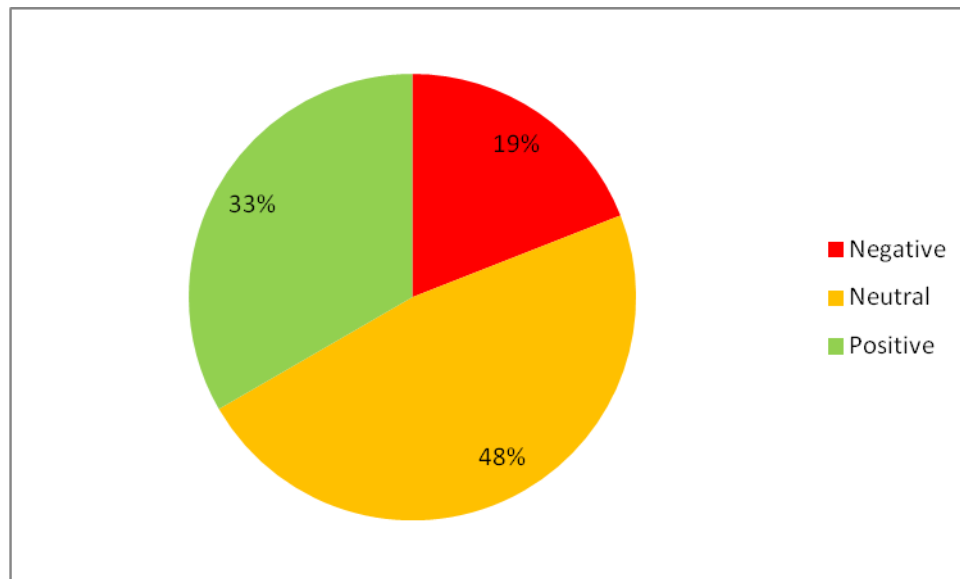

Figure 46 : Summarised opinion of the participant social network on the green watch concept

5.6.2.2.4 K7.1 Situated cognition: Medium

Situated cognition is approximated by the variety of contexts in which participants identify cues that make them consult the watch. It is also qualified during the debriefing where participants were asked to identify what triggered discussion about the watch at each occurrence.

During the debriefing other ‘K’ properties were assessed such as K2.1. and K5.1. A visual trigger (flashy green) on the watch as well as the haptic sensation of wearing a watch were not considered strong enough to consult the watch but were enough to recall the presence of the

watch and therefore of the possibility to get information about the environment. Such triggers could occur during any activity as participants were wearing short sleeves; they were stronger for participants not wearing watches or bracelets.

Table 45: Contexts of use for the fake green watch

	User 1 (11)	User 2 (10)	User 3 (17)	User 4 (15)	User 5 (15)	Total (68)	#user havin g quote d the activi ty
I was working, I was studying	10	0	3	10	6	29	4
I was meeting someone	1	0	0	0	1	2	2
I was travelling, I was driving, I was around	10	3	5	13	3	34	5
I was cooking	1	1	2	0	3	7	4
I was getting dressed, I was putting my shoes, I was putting my make-up	0	0	0	0	2	2	1
I was washing, I was swimming	0	1	0	0	0	1	1
I was doing the housework, I was working in the house	1	3	2	0	0	6	3
I was doing administrative work	0	0	1	0	1	2	2
I was shopping	0	3	1	4	0	8	3
I was waiting	1	4	0	4	3	12	4
I was working with children or animals or adults	0	4	0	1	1	6	3
I was resting	0	1	1	0	0	2	2
I was sick in bed	0	1	0	0	0	1	1
I was meditating	0	0	0	0	0	0	0
I was talking	0	0	0	0	3	3	1
I was eating or drinking or I was smoking	7	0	0	0	7	14	2
I was on the internet	0	0	0	0	0	0	0
I was playing video games	0	0	0	0	0	0	0
I was watching a movie, listening to music	0	1	0	0	0	1	1
I was reading	0	0	2	0	0	2	1
I was at a concert, show, exhibition, sporting event	0	0	0	0	0	0	0

	ELLIOT – Experiential Living Lab for the Internet Of Things	Project N.	258666
	D4.3.2 – Report on IOT Living Labs Continuous Exploration and Evaluation (interim)	Date	31.08.2012

I was gardening, I fished, I hunted, I was hiking	0	2	8	0	0	10	2
I played sports	6	0	1	0	2	9	3
I sang	0	0	0	0	0	0	0
Other specify ...	4	5	0	2	0	11	3
Total	41	29	26	34	32	162	

Green cells highlight activities performed by more than 80% of the participants.

Yellow cells highlight activities performed by between 40 and 60 % of the participants.

Inactivity (or waiting for transportation, a friend, client etc...) was not mentioned as a relevant trigger for consulting the watch. However, one participant did mention that she tends to arrive early at her professional appointments in order to document meeting places and would therefore use the watch in order to measure the air quality of the places (this type of situation is reported by the participant as a waiting situation). Moreover, during these waiting periods as well as during the working periods some participants did report that they were more attentive to the evaluation of the external situation while waiting or while taking micro-breaks at work.

The most effective triggers were related to the participants' perception of the air/noise/temperature/light etc i.e. were mediated by participants' physiological senses. Discovering new places was as well reported as creating the need for consulting the watch.

As shown in Table 46, participants⁵ consulted the fake watch both indoors and outdoors. This result is reassuring as it shows that outdoor citizen measurements are relevant, while most popular setting for green IoT (fixed) devices such as home, office, restaurant etc (cf. both mobility and health/well being GenIoT experiments) were indoors.

As shown by the overall number of contexts of consultation, all participants did consult their watch while being on a means of transportation. This is the only context where all participants did consult the watch. However, data consulted at that time was mainly related to internal pollution and not to the external air that they may have considered as polluted.

⁵ Participants were purposely not told that the real watch does not provide reliable air measurements in close setting.

Table 46: Variations in the activities leading to watch consultation

	User 1	User 2	User 3	User 4	User 5	Total
Number of different activities	9	12	9	6	11	47
Length of the study (in days)	11	10	17	15	15	68
average number of contexts quoted at least once per user	0,8	1,2	0,53	0,4	0,73	0.70

After having reviewed the data, thresholds for the rules were set as: $\alpha=0,5$ and $\beta=1$

As a consequence, the situated cognition per user can be assessed as shown in Table 47.

Table 47: Individual assessment of K7.1 (situated cognition)

	User 1	User 2	User 3	User 4	User 5
K1.7	high	high	medium	low	medium

Please note that, situated cognition seems to be higher for the “environmental analysts” as they take into consideration more contexts than the other participants. Numerical calculations also lead to an overall evaluation of situated cognition for the service of 0.70 i.e. medium. ($\alpha=2$, $\beta=4$).

If average number of contexts quoted at least once per user < 2

then K7.1 is low

If $2 \leq$ average number of contexts quoted at least once per user < 4

then K7.1 is medium

If average number of contexts quoted at least once per user ≥ 4

then K7.1 is high

5.6.3 Conclusion

On the content level the first co-creation series of workshops based on the theme of urban

	ELLIOT – Experiential Living Lab for the Internet Of Things	Project N.	258666
	D4.3.2 – Report on IOT Living Labs Continuous Exploration and Evaluation (interim)	Date	31.08.2012

mobility advanced the notion of health and well-being. A similar phenomenon is observed in the health-oriented workshops: participants saw transportation information inserted within the air/health based green services. This reaffirms the ICT Usage Lab researchers in the viewpoint that was initially seen as two use case scenarios – the mobility scenario and the health/well-being scenario should actually merge into a single green services scenario where localisation of the air/noise pollution is presented as well as transportation alternatives.

	ELLIOT – Experiential Living Lab for the Internet Of Things	Project N.	258666
	D4.3.2 – Report on IOT Living Labs Continuous Exploration and Evaluation (interim)	Date	31.08.2012

6 Conclusions [UOR]

This deliverable D4.3.2 summarises the Living Lab experimentation progress achieved since the delivery of ELLIOT deliverable D4.3.1.

In comparison to D4.3.1, the Living Lab experimentation now involves a larger number of IoT sensors and devices and their integration into the Living Lab experimentation is now better understood. Using IoT devices in Living Lab experimentation cycles remains challenging in particular in co-creation exercises that address devices and/or environments that are not readily available to be “IoT”-enabled. The described co-creation work carried out at BIBA shows how co-creation and IoT device usage can be facilitated in suitable environments and in situations where, for example, scale models of environments or vehicles can be made available. In exploration and experimentation phases, the use of IoT devices will generally have been roughly defined (including through co-creation phases); hence these phases appear to be better-suited for deployment of IoT devices and resulting data analyses using KSB indicators.

Regarding KSB indicators, the involved Living Lab partners have made progress in simplifying and focusing the KSB model properties used, which has made working with the model easier for the Living Lab partners involved.

Further work on technical integration and further experimentation is currently ongoing and will be reported on in the third a final reporting deliverable iteration, deliverable D4.3.3.

	ELLIOT – Experiential Living Lab for the Internet Of Things	Project N.	258666
	D4.3.2 – Report on IOT Living Labs Continuous Exploration and Evaluation (interim)	Date	31.08.2012

7 References

- [1] Vicini, S., Bellini, S., Sanna, A., “A Living Lab for Internet of Things Vending Machines”, The Impact Of virtual, remote, and real logistics labs, Communications in Computer and Information Science, 2012, Volume 282, Part 2, 35-43, DOI: 10.1007/978-3-642-28816-6_4.
- [2] Vicini, S., Bellini, S., Rosi, A., Sanna, A., “An Internet of Things enabled Interactive Totem for Children in a Living Lab setting”, ICE conference paper 2012
- [3] Vicini, S., Bellini, S., Sanna, A., “How to Co-Create Internet of Things-enabled Services for Smarter Cities”, SMART 2012, The First International Conference on Smart Systems, Devices and Technologies, May 2012. ISBN: 978-1-61208-225-7
- [4] Meaningful Measures: Valid Useful User Experience Measurement (VUUM), Effie L-C. Law & the VUUM Program Committee, COST294-MAUSE (<http://www.cost294.org>)
- [5] Developing Usability Methods for Multimodal Systems: The Use of Subjective and Objective Measures, Anja B. Naumann & Ina Wechsung
- [6] Classifying and Selecting UX and Usability Measures, Nigel Bevan
- [7] Towards Practical User Experience Evaluation Methods, Kaisa Väänänen-Vainio-Mattila, Virpi Roto, Marc Hassenzahl
- [8] Comparing UX Measurements, a case study, Arnold P.O.S. Vermeeren, Joke Kort, Anita H.M. Cremers & Jenneke Fokker
- [9] Nielson, J., Usability Engineering, Morgan Kaufmann, San Francisco, 1993
- [10] Negri A.-L., Trousse, B., Senach, B. “Ideation of IoT services with citizen : coupling GenIoT and AloHa”, ServDes conference, Espoo, 8-10 Feb., 2012.

8 Appendix: Green Services Use Case [INRIA]

8.1 User profiles

8.1.1 Experimentation 1

8.1.1.1 Generic questions

What is your main mode of transportation? You can check up to three.

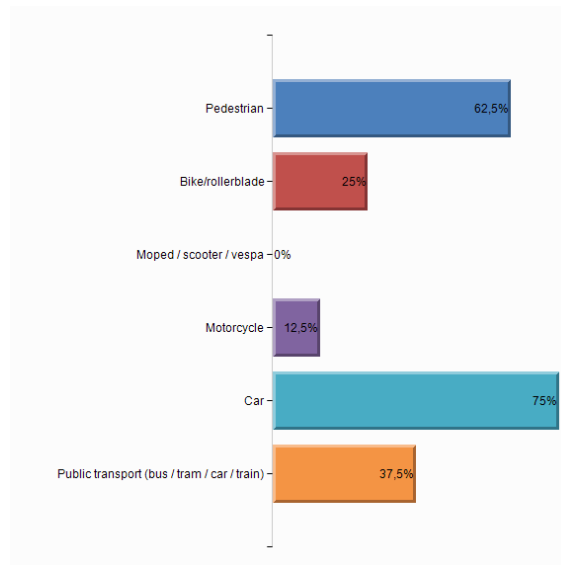

What is your level of knowledge in the field of air quality?

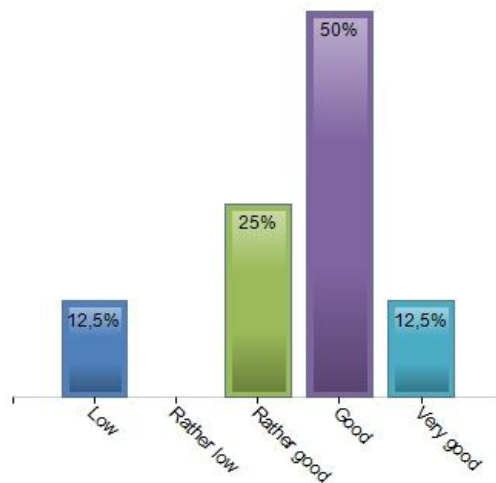

To what extent do you consider that you work for Sustainable Development?

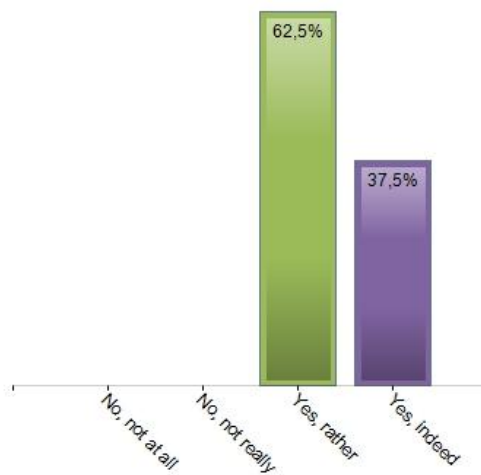

Do you belong to an association or sports club?

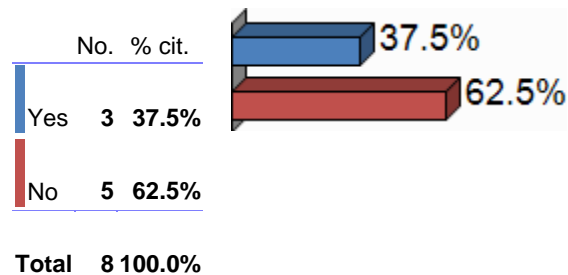

Do you play a sport regularly outside?

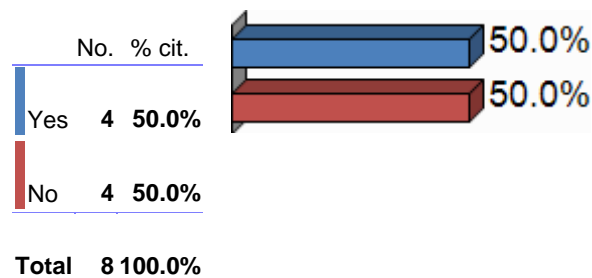

	ELLIOT – Experiential Living Lab for the Internet Of Things	Project N.	258666
	D4.3.2 – Report on IOT Living Labs Continuous Exploration and Evaluation (interim)	Date	31.08.2012

How often?

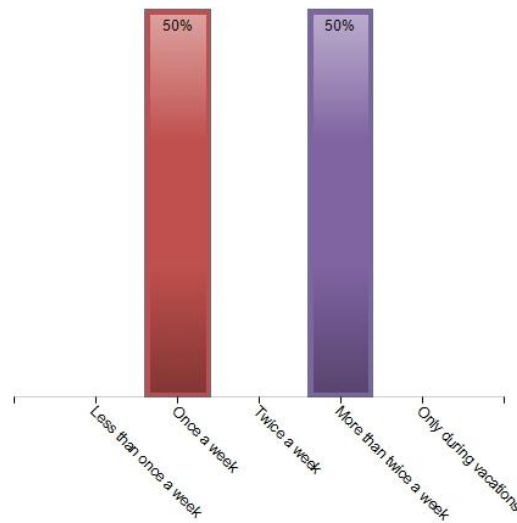

8.1.1.2 Participants and Sustainable Development

Do you work in the field of sustainable development?

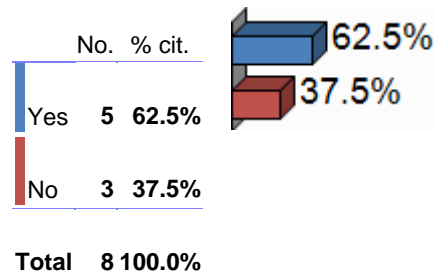

Indicate your accession at the following statements:

	No, not at all	No, not really	Yes, rather	Yes, indeed	Total
I am involved in projects in my neighbourhood	1	5	1	1	8
I buy organic food or fair (incl. AMAP)	0	2	5	1	8
I am active in a charitable, environment	0	3	2	3	8
I am careful not to pollute	0	0	3	5	8
I prefer cycling, public transport and car pooling	0	2	2	4	8

I sort and recycle my household waste	0	0	3	5	8
I have put in place energy saving measures	0	3	2	3	8
Total	1	15	18	22	56

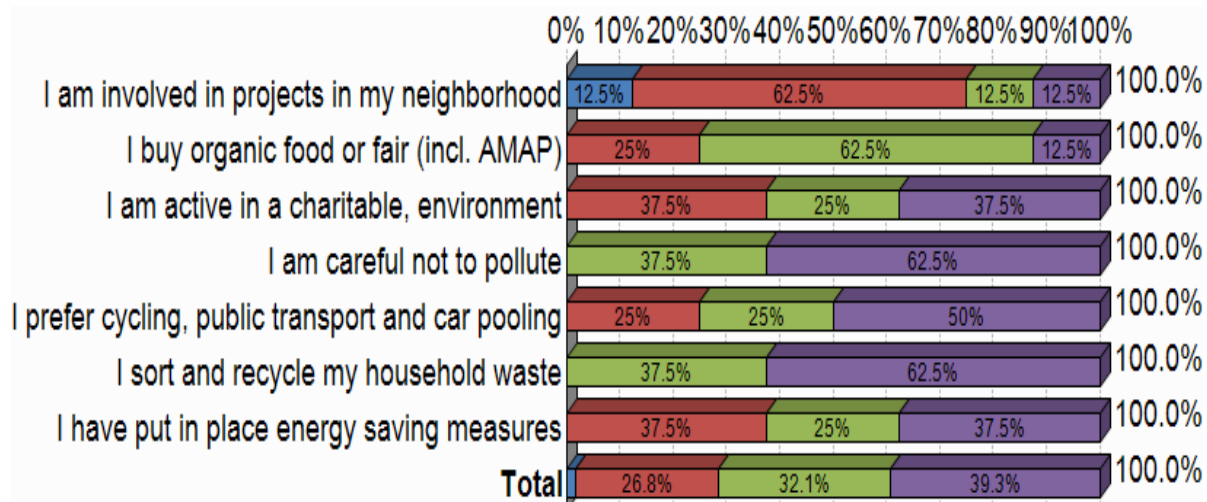

8.1.1.3 Your relation to information and communication technology (ICT)

Please indicate if you have the following equipment

	Yes	No	Total
Internet home	8	0	8
Cell phone	8	0	8
Internet mobile access	5	3	8
Laptop	7	1	8
Tablet	3	5	8
Computer	6	2	8
Webcam	6	2	8

Digital Camera (incl. cell phones)	8	0	8
Weather station	2	6	8
Do you connect to the internet via mobile devices?	4	4	8
Total	57	23	80

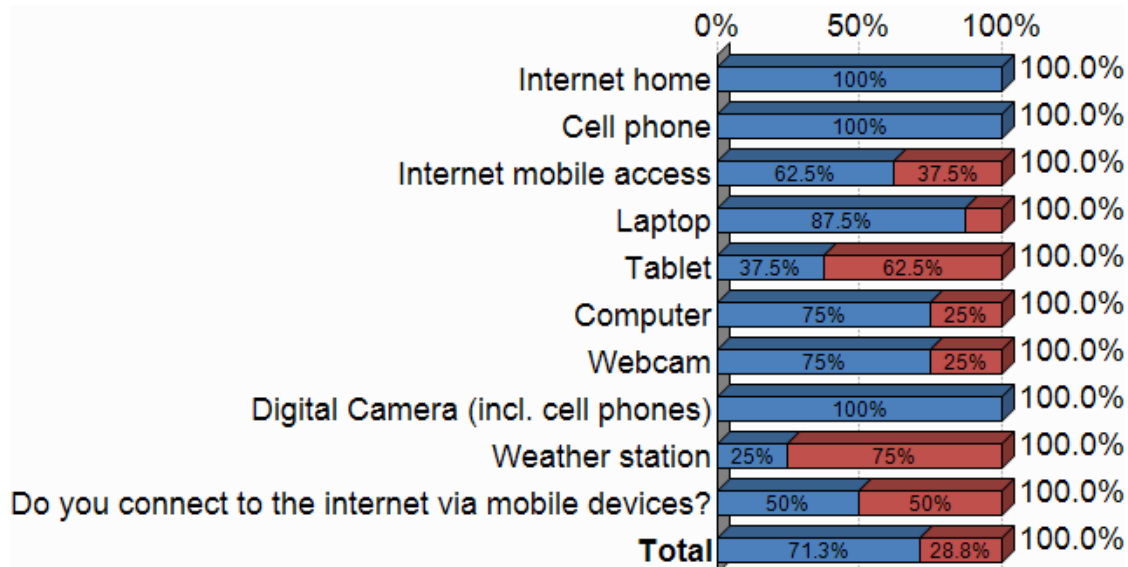

If you had to estimate your mobile phone use, would you say you are?

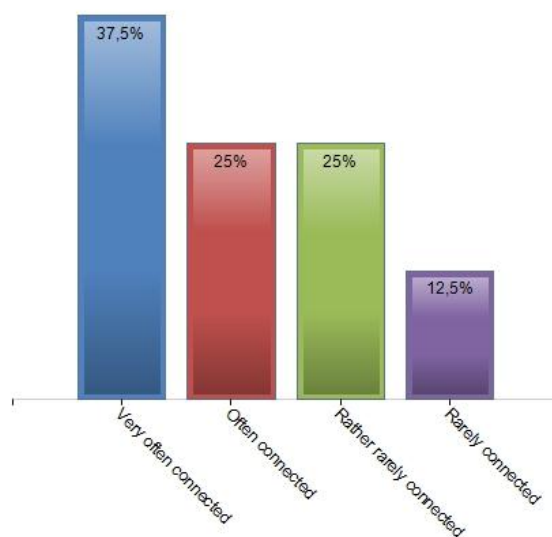

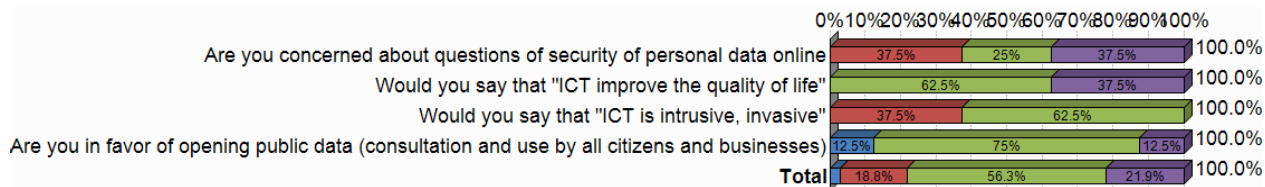

About your relationship to ICT, please answer the following questions

	No, not at all	No, not really	Yes, rather	Yes, indeed	Total
Are you concerned about questions of security of personal data online	0	3	2	3	8
Would you say that "ICT improve the quality of life"	0	0	5	3	8
Would you say that "ICT is intrusive, invasive"	0	3	5	0	8
Are you in favour of opening public data (consultation and use by all citizens and businesses)	1	0	6	1	8
Total	1	6	18	7	32

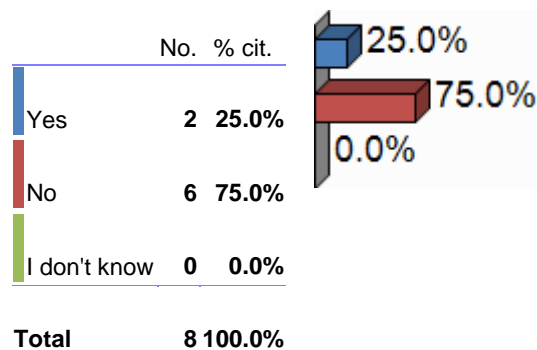

Have you ever used contactless payment?



	ELLIOT – Experiential Living Lab for the Internet Of Things	Project N.	258666
	D4.3.2 – Report on IOT Living Labs Continuous Exploration and Evaluation (interim)	Date	31.08.2012

What is your use of ICT?

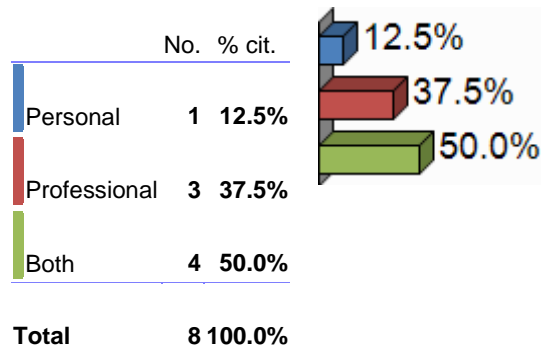

On the internet, what are your main activities? Check up to 4 uses

	No.	% obs.
Webmail	7	87.5%
Search	8	100.0%
Online shopping	5	62.5%
Entertainment online (watch videos online, games, listen music in streaming (Deezer, Spotify, etc.))	1	12.5%
Instant Messaging, read blogs, consulting social media (facebook status read, etc.)	2	25.0%
Download of entertainments (download videos, music and podcasts)	1	12.5%
Active engagement with social media (blog creation, photo album creation, updating profiles facebook, linkedin, twitter , etc.)	1	12.5%
Total	8	

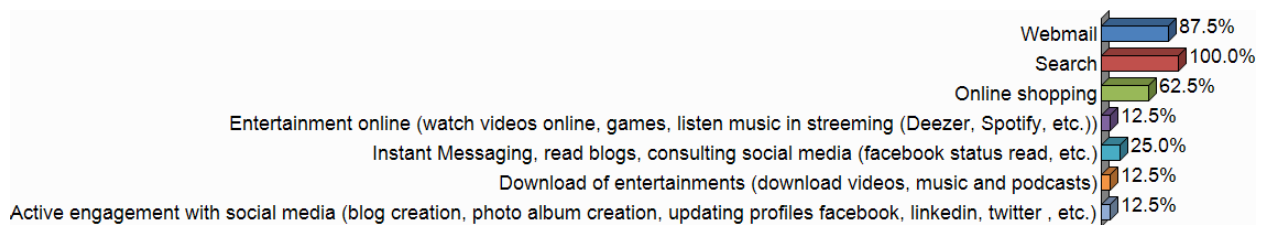

8.1.1.4 Participants and cardio-respiratory diseases

Is someone close to you it concerned with cardiorespiratory diseases?

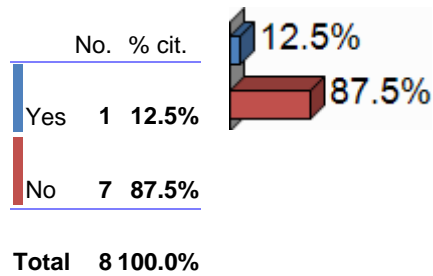

Are you working in the field of health or welfare?

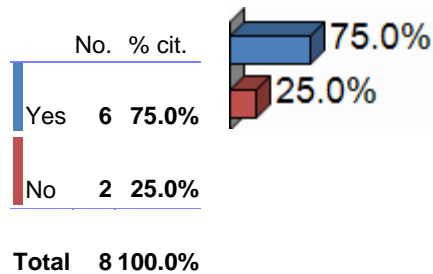

Are you personally concerned by a respiratory problem?

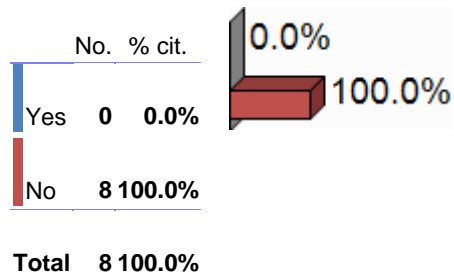

What type of respiratory illness are you suffering from?

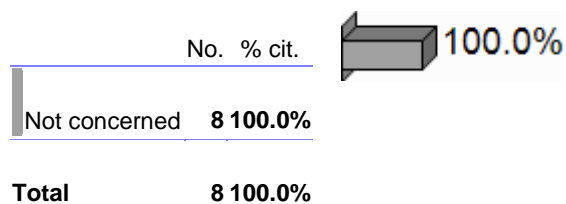

As part of your condition, are you required to adopt particular behaviors?

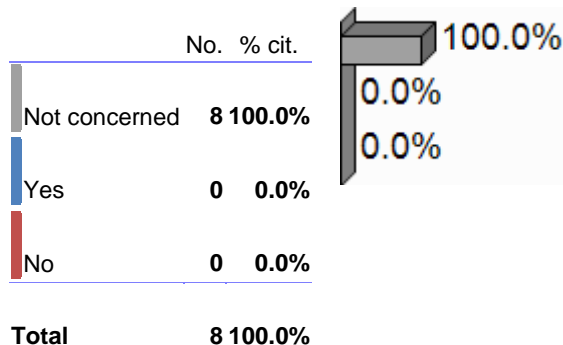

Do you consider useful to have real time information on air quality?

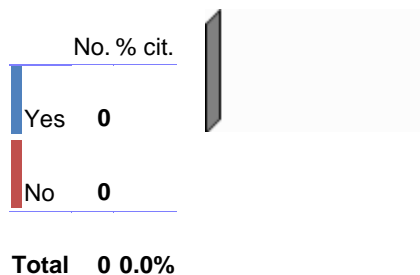

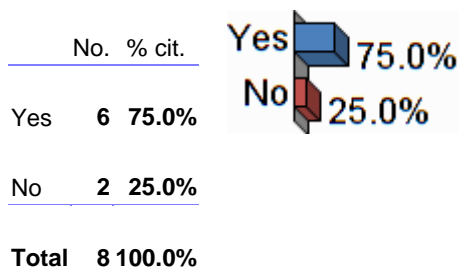

8.1.1.5 Knowledge of Green services

Do you know services (websites, phone applications, etc.) providing information on air quality or noise pollution?

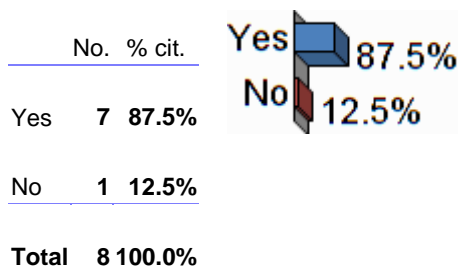

Do you know Air PACA?



	ELLIOT – Experiential Living Lab for the Internet Of Things	Project N.	258666
	D4.3.2 – Report on IOT Living Labs Continuous Exploration and Evaluation (interim)	Date	31.08.2012

Among these four styles, which do you feel closest to?

	No.	% cit.
I am methodical and reflective. I plan and I decide. I'm looking for practical applications to the concepts and theories. (Central Question: How?)	0	0.0%
I'm intuitive and pragmatic. I generate solutions. I interpret practical situations, different points of view. (Central Question: Why?)	3	37.5%
I'm intuitive and reflexive. I plan and formulate theories. I appropriate a wide range of information and integrates them in a concise and logical process. (Central Question: What?)	2	25.0%
I am methodical and pragmatic. I run and I realise. I implement practical experiences and personally get involved in new experiences with a challenge. (Central Question: What happens if?)	3	37.5%
Total	8	100.0%

8.1.1.6 Demographic Profile

Are you?

	No.	% cit.
Man	2	25.0%
Woman	6	75.0%
Total	8	100.0%

	ELLIOT – Experiential Living Lab for the Internet Of Things	Project N.	258666
	D4.3.2 – Report on IOT Living Labs Continuous Exploration and Evaluation (interim)	Date	31.08.2012

Age?

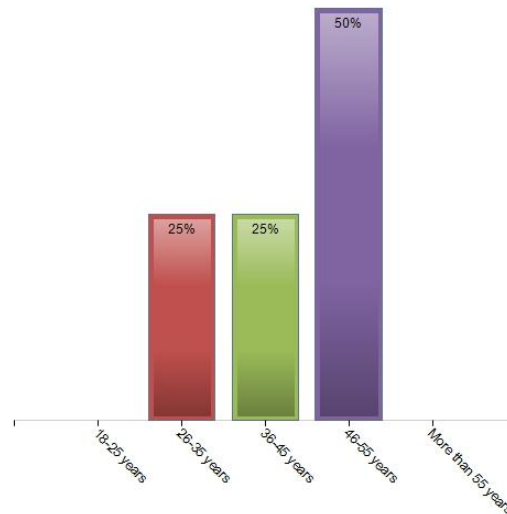

Do you have at least one child (minor)?

	No.	% cit.
Yes	6	75.0%
No	2	25.0%
Total	8	100.0%

City of work

	No.	% cit.
Nice	5	62.5%
Grasse	1	12.5%
Marseille	1	12.5%
Mouans-Sartoux	1	12.5%
Total	8	100.0%

In which occupational group do you fall?

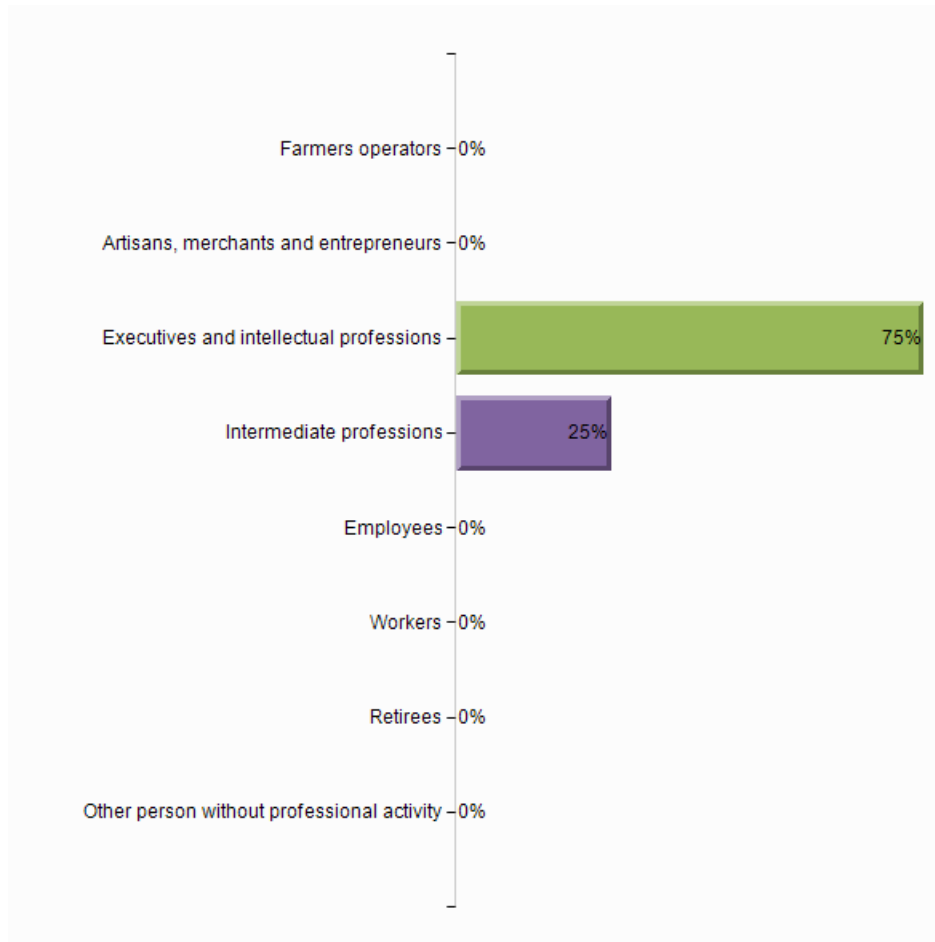

8.1.2 Experimentation 2

Profile of the participants to the Fake green watch experimentation (#2), Green services Use case

What is your primary mode of transportation? You can check up to three.

Response rate: 100%

	Nbr % obs.
Pedestrians	5 83.3%
Cycling / biking blue / rollerblading	2 33.3%
Moped / scooter / vespa	0 0.0%
Motorcycle	0 0.0%
Car	5 83.3%

	ELLIOT – Experiential Living Lab for the Internet Of Things	Project N.	258666
	D4.3.2 – Report on IOT Living Labs Continuous Exploration and Evaluation (interim)	Date	31.08.2012

Public transport (bus / tram / car / train) **4 66.7%**

Total 6

What is your level of knowledge in the field of air quality?

Response rate: 100%

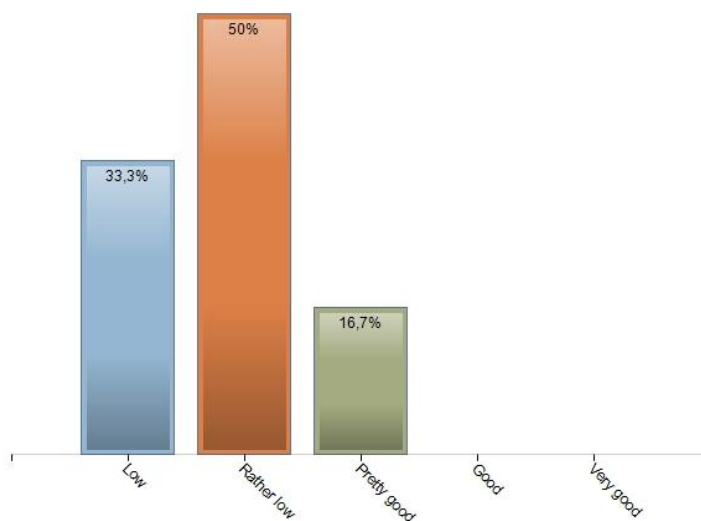

To what extent would you say you work for Sustainable Development?

Response rate: 100%

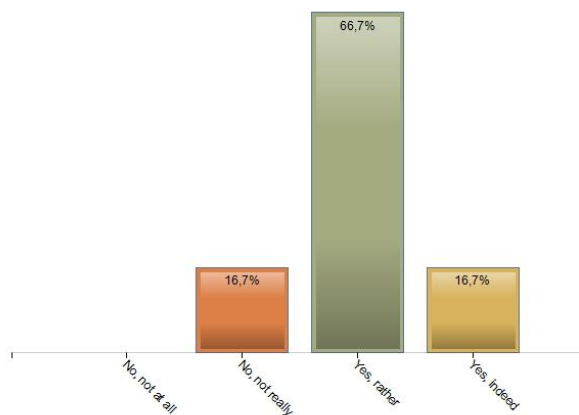

	ELLIOT – Experiential Living Lab for the Internet Of Things	Project N.	258666
	D4.3.2 – Report on IOT Living Labs Continuous Exploration and Evaluation (interim)	Date	31.08.2012

Do you belong to an association or club sports?

Response rate: 83.33%

	Nbr	% cit.
Yes	3	60.0%
No	2	40.0%

Total 5 100.0%

Do you play a sport regularly outside?

Response rate: 100%

	Nbr	% cit.
Yes	3	50.0%
No	3	50.0%

Total 6 100.0%

How often?

Response rate: 50%

	Nbr	% cit.
Less than once a week	0	0.0%
Once a week	0	0.0%
Twice a week	3	100.0%
More than twice a week	0	0.0%
Only during vacations	0	0.0%
Total	3	100.0%

Do you work in the field of sustainable development?

Response rate: 100%

	Nbr	% cit.
Yes	2	33.3%
No	4	66.7%
Total	6	100.0%

Please indicate your adhesion to the following statements:

	No, not at all	No, not really	Yes, rather	Yes, indeed
I am involved in projects in my neighbourhood	33.3%	50.0%	16.7%	0.0%
I buy organic produce or fair (incl. AMAP)	0.0%	16.7%	33.3%	50.0%
I am active in a charitable, civic or ecological	50.0%	0.0%	0.0%	50.0%
I am careful not to pollute	0.0%	0.0%	50.0%	50.0%
I prefer cycling, public transport and car pooling	0.0%	20.0%	60.0%	20.0%
I sort and recycle my household waste	0.0%	16.7%	0.0%	83.3%
I have implemented energy saving measures	0.0%	0.0%	83.3%	16.7%

8.2 Questionnaire

1. How many times have you looked at your watch today?

Inside

Outside

	ELLIOT – Experiential Living Lab for the Internet Of Things	Project N.	258666
	D4.3.2 – Report on IOT Living Labs Continuous Exploration and Evaluation (interim)	Date	31.08.2012

Mode of transportation

2 What information did you consult?

- | | |
|--|--|
| <input type="checkbox"/> Air Quality Index | <input type="checkbox"/> Humidity |
| <input type="checkbox"/> Ozone | <input type="checkbox"/> Temperature |
| <input type="checkbox"/> NO2 | <input type="checkbox"/> Next Bus |
| <input type="checkbox"/> Pollen | <input type="checkbox"/> Other specify |
| <input type="checkbox"/> CO2 | |
| <input type="checkbox"/> Noise | |

3. In what context were you?

- | | |
|--|---|
| <input type="checkbox"/> I was working, I was studying | <input type="checkbox"/> |
| <input type="checkbox"/> I was meeting | <input type="checkbox"/> I was sick in bed |
| <input type="checkbox"/> I was traveling, I was driving, I was moving | <input type="checkbox"/> I was doing meditation |
| <input type="checkbox"/> I was cooking | <input type="checkbox"/> I was talking |
| <input type="checkbox"/> I was preparing my self | <input type="checkbox"/> I was eating or drinking or smoking |
| <input type="checkbox"/> I was washing my self | <input type="checkbox"/> I was on internet |
| <input type="checkbox"/> I was doing the housework, I was tinkering around | <input type="checkbox"/> I was playing video games |
| <input type="checkbox"/> I was doing administrative work | <input type="checkbox"/> I was watching a movie, listening to music |
| <input type="checkbox"/> I was shopping | <input type="checkbox"/> I was reading |
| <input type="checkbox"/> I was waiting | <input type="checkbox"/> I was at a concert, show, exhibition or sporting event |
| <input type="checkbox"/> I was working with children or adults or animals | <input type="checkbox"/> I was gardening, I was fishing, I was hunting, I was hiking. |
| <input type="checkbox"/> I was resting | <input type="checkbox"/> Other specify |

4. Which decision did you take after looking at the watch?

- | | |
|---|--|
| <input type="checkbox"/> Rerouting | <input type="checkbox"/> Taking medication |
| <input type="checkbox"/> Communication at third | <input type="checkbox"/> No change |
| <input type="checkbox"/> Activity Report | <input type="checkbox"/> Consultation Only |
| <input type="checkbox"/> Change of mode of transportation | <input type="checkbox"/> Other specify |
| <input type="checkbox"/> Change my personal schedule | |

5. Did you talk about the watch with other people?

	ELLIOT – Experiential Living Lab for the Internet Of Things	Project N.	258666
	D4.3.2 – Report on IOT Living Labs Continuous Exploration and Evaluation (interim)	Date	31.08.2012

- Yes
- No

6. Who?

- Spouse, Partner
- Kids
- Other family members
- Colleagues
- Boyfriend/Girlfriend,
- Clients
- Friends
- Other specify

7. What was their reaction?

- Doubtful
- Surprised
- Interested
- Refractory
- Amused
- Not interested
- Other specify

8.3 Green Services: IoT Sensor Data Collection and Analysis

Two versions of green services are planned related to our Living Lab evolution process. Our first version of green services (v1, being implemented at the time of writing) will be improved at the end of November using the user feedback as shown in Figure 26. As mentioned in Section 5.1, phase 2 has been begun with the development of the version 1 of green services based on the results of previous steps (co-creation and exploration steps).

Figure 47 presents a user-centered overview of the green services use case with the three different roles represented in our use case.

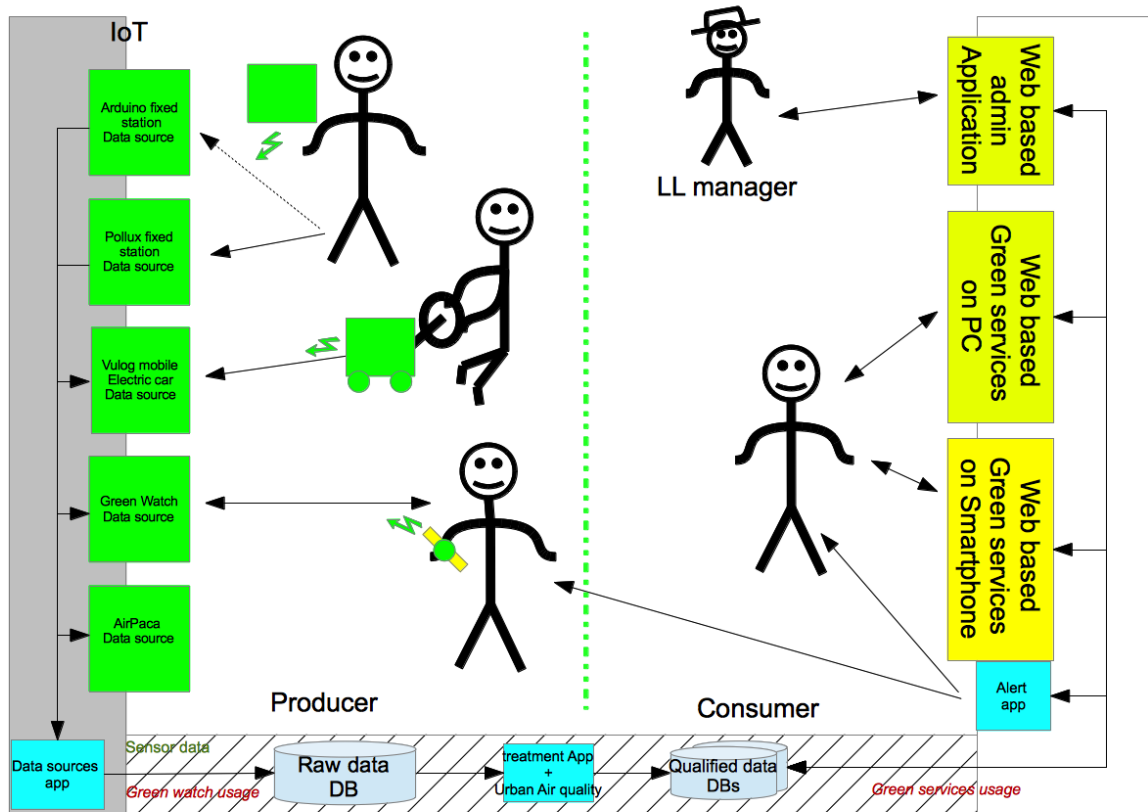



Figure 47: Green services applications

The Web-based green services applications aims to support both the health & well-being and mobility scenarios. User preferences can be adjusted by citizens to define their chosen alerts and the data to visualize.

Green services are developed by AxIS@INRIA from the ICT Usage Lab in collaboration with

	ELLIOT – Experiential Living Lab for the Internet Of Things	Project N.	258666
	D4.3.2 – Report on IOT Living Labs Continuous Exploration and Evaluation (interim)	Date	17.09.2012

several partners: a) environmental data providers (AIRPACA, VUIOG, FING in relation with PODIUM and CKAB), b) environmental data analysis (AIRPACA, INRIA).

Below, the IoT Sensor Data is reported on collected by the Green Services data server. A REST API has been implemented to save data in the green services data server.

In addition to the IoT data collection, other developments related to the user needs in terms of visualisation of IoT data (maps), alerts, user preferences and so on are in progress. Different user interfaces for the green services use case are in development (for computer and for smart phone, an additional administration interface for green services is also implemented). A specific interface for the administrator of green services is also implemented. The two planned versions of green services (v1 and v2) will be reported in the upcoming deliverable D4.3.3 with the results of our two next experimentations (v1, v2) based on green services.

8.3.1 Air quality Air PACA fixed sensors (resp: Inria)

8.3.1.1 Sensors

Five fixed air stations in Nice and 2 in Antibes are planned to be used. Observed data will be collected every hour.

Table 48: Sensors involved in the green watch

Locality	Sensors
Nice Airport (Nice)	NO2, O3, SO2 et PM10
West botanic (Nice)	O3
Lenval (Nice)	NO2 et PM10
Pellos (Nice)	NO2 et SO2
Paillon (Nice)	PM10
Moulin (Antibes)	NO2, O3 et PM10
Guynemer (Antibes)	NO2

8.3.1.2 IoT connectivity

Air PACA will post one file with air quality measures by station to the Air PACA server every hour. The green services application reads these files hourly and stores data updates in the “raw data DB” on a secured INRIA server.

8.3.2 Green watches: FING (resp) + INRIA

FING is involved in a consortium with other partners aiming to design the second version of the green watch and a new Citypulse platform. Sixteen green watches are expected to be available for the ELLIOT project: 6 provided by FING and 10 by INRIA (out of ELLIOT budget).

8.3.2.1 Sensors

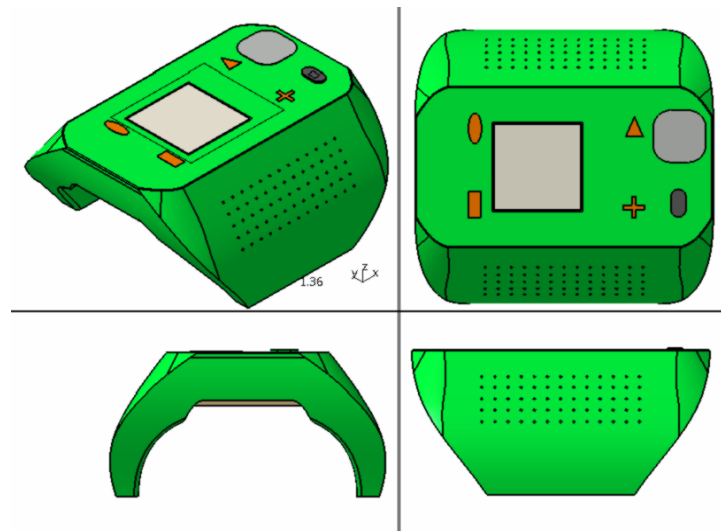

Figure 48: green watch (2nd version)

Table 49: Sensors involved in the green watch

03	ppb, +/-20 ppb (20-200 ppb)
NO2	Ppb, +/- 20 ppb (20-200 ppb)
noise	dBA, +/- 3dB
temperature	t°
GPS	Mercator transformed in WGS84

8.3.2.2 IoT connectivity

The behaviour of the green watch (user alerting, type(s) of measure(s) displayed/used for events, collection/transmission of data etc.) is configured via a programmable automat that requires the specification of usage scenarios. The green watch user interface will be composed of a screen (96x96 px, monochrome), four buttons and an amplificatory (noisy BIP). The green watch will have 4 LEDs visible on the side of the watch; the LEDs can be used for instance to visually alert the user in case of pollution. User interactions with green watches as well as measured IoT data will be logged.

The various modes between the green watch and the supervision server called M2M are managed by the applicative software of the green watch via the **WLM Wireless Module**. The communication uses a wireless communication network (GPRS ...). An API is implemented to manage WLM.

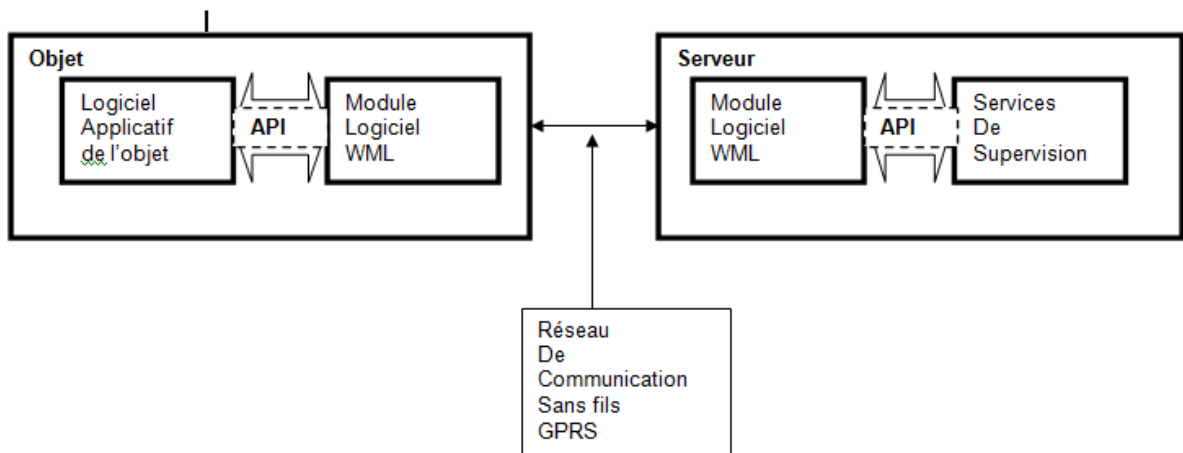

Figure 49 : Data transmission between green watch and data server

|Home| |About| Welcome gw3, [Logout](#) Today is May 13 2012 05:14:13

MAIN MONITORING CONFIGURATION ACCOUNT

Control Settings| Chart| Export

SN-06-12-10-006 Maintain All in AUTO Set scheme Set action

Block Name	State/Profile	Scheme	Connection Mode	gps	rtc_modulo_event	Conf
SN-06-12-10-006	CONF / Standard	POWER_OFF	N / A	N / A	N / A	
SN-06-12-10-007	AUTO	POWER_OFF	RCX@10:11:56	[175598591, 7207058]@01:19:05	N / A	

1 of 1

Figure 50 : Interface for data collection on Webtalk (selection of GPS)

	ELLIOT – Experiential Living Lab for the Internet Of Things	Project N.	258666
	D4.3.2 – Report on IOT Living Labs Continuous Exploration and Evaluation (interim)	Date	17.09.2012

Green services (v1): The data collection from Green Watch data server (related to IoT) for Green services (v1) data server (v1) have been implemented and tested. The past and current work deals with:

- the definition of the usage scenario,
- the implementation of the different pages displayed on the screen,
- data collection from the GW data server related to the user interaction with the watch via the four buttons such as:
 - “I want to have more details on air measures”,
 - “I see the alert”,
 - “I want to store location and environmental measures”,
 - “I want to send the alert to a friend”,
 - answers to context-aware questions (e.g. in case of pollution alert) ,
 - “I would like to check whether the network coverage is fine”.

Green services data are communicated using XML data markup as illustrated in the example below:

	ELLIOT – Experiential Living Lab for the Internet Of Things	Project N.	258666
	D4.3.2 – Report on IOT Living Labs Continuous Exploration and Evaluation (interim)	Date	17.09.2012

```

<ws_data>
  <auth>
    <user>PodiumIT1</user>
    <pass>passwd</pass>
  </auth>
  <blocks>
    <block>
      <block_id>921</block_id>
      <result>
        <time>2012/09/05 13:13:08 GMT</time>
        <o3_ppb>52</o3_ppb>
        <no2_ppb>52</no2_ppb>
        <bruit_db>0</bruit_db>
        <bruit_dba>0</bruit_dba>
      </result>
      <result>
        <time>2012/09/05 13:13:08 GMT</time>
        <temperature>-271.9</temperature>
        <humidity>5</humidity>
      </result>
      <blck_dtlastchg>2012/08/30 10:34:05 GMT</blck_dtlastchg>
    </block>
  </blocks>
</ws_data>

```

8.3.3 *Electric vehicles based sensors: VUIOG (resp)*

2 to 5 EV-based sensors are planned by VUIOG in relation with NCA.

8.3.3.1 Sensors

There are important delays in selecting the sensors and to equip electric vehicles. In June, VUIOG changed the air quality sensor. Mid-August, one vehicle was equipped and will be tested in September. VUIOG announced that 1 to 4 additional vehicles would be equipped with sensors later.

	ELLIOT – Experiential Living Lab for the Internet Of Things	Project N.	258666
	D4.3.2 – Report on IOT Living Labs Continuous Exploration and Evaluation (interim)	Date	17.09.2012



Figure 51: EV-based sensors (equipped MIA)

Table 50: Sensors on a electric car

PM10	Under development
03-NO2	ppm
noise	dBA, +/- 0,1dBA, measure from 0 to 120dBA
temperature	°, +/- 0,4°, measure from -40° to + 120°
humidity	%, +/- 3%, measure from 0 to 100%
GPS	WGS84

8.3.3.2 IoT connectivity

Each car is equipped with an embedded computer called “vubox”. Based on ARM processor technology and with machine-to-machine communication (GPRS) and positioning (GPS) capabilities. In this way, car data are accessible 24/7.

Custom software developed for the Elliot project communicates with the smart sensor through a serial link RS232. This sensor realises the measure: analogue acquisition, digitalise, filtering, buffering. The vubox controls the rate of acquisition and of transfer to the server using GPRS technology.

The ELLIOT Web Service for electric cars is a SOAP implementation of Web Services. The WSDL descriptor is available at the same address of the general server; access is restricted with a security code (KEY).

	ELLIOT – Experiential Living Lab for the Internet Of Things	Project N.	258666
	D4.3.2 – Report on IOT Living Labs Continuous Exploration and Evaluation (interim)	Date	17.09.2012

- The service GetTracerIds(string KEY) gives the real time list of vehicles equipped with sensor.
- The service GetTracerSerie(KEY, tracerId, day) gives the sensors data of a given car and a given date & day.

For the first vehicle, a prototype system is installed on the roof of the car. Each vehicle provides data under the same structure: Date (UTC), location (WGS84), sensor data (0...N). The sensor data field contains the type and the measure itself.

Each sensor has a meta description including its name, the unit of the measure and an identifier. A general structure has been developed to enlarge the scope of the software to any kind of environmental measurement.

The first sensor, which was installed at the end of August, has a 5 minutes transmission rate.

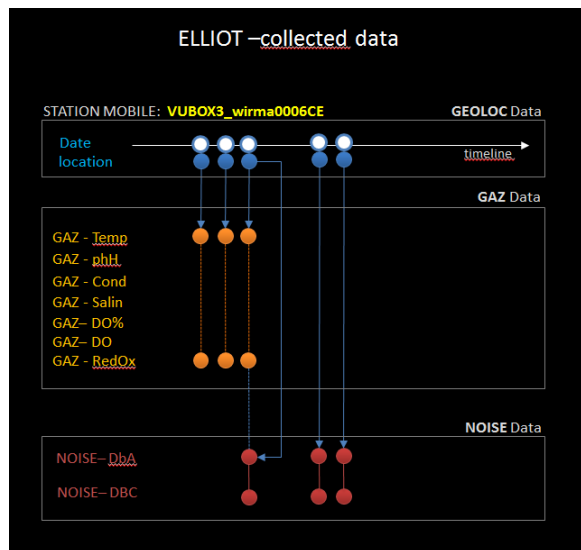



Figure 52 : Example of sensor collection

	ELLIOT – Experiential Living Lab for the Internet Of Things	Project N.	258666
	D4.3.2 – Report on IOT Living Labs Continuous Exploration and Evaluation (interim)	Date	17.09.2012

This has to be tuned to take into account the cost of the transmission. First data available are:

- Temperature (+/- 0,4°)
- Noise level (+/- 0,1 dBA)
- Humidity (+/- 3%)
- Pollution, measure by a mix of O3 and N02 gas (ppm)

The PM10 sensor is not yet available.

Data collected by VULOG server are structured in a hierarchical manner: starting in the root folder, data are organized by year, month and day. Each day folder may contain as many “vml” data files as there are active tracers.

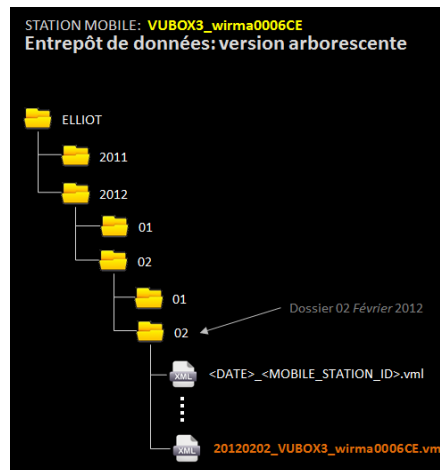



Figure 53 : Example of data structure

Green services (v1): the data collection from VULOG data server by GS v1 has been implemented and tested on the 27th of February. Due to the change of sensors by VUIOG and a new specification of the VULOG data server, INRIA has updated this implementation and has re-tested the data collection in real-time with the first equipped vehicle at the beginning of September.

The current VULOG data server uses the following format:

```
<soap:Envelope xmlns:soap="http://schemas.xmlsoap.org/soap/envelope/"
  xmlns:i="http://www.w3.org/2001/XMLSchema-instance"
  xmlns:s="http://www.w3.org/2001/XMLSchema">
  <soap:Body>
    <GetTracerSerieResponse xmlns="http://vulog.com/">
```

	ELLIOT – Experiential Living Lab for the Internet Of Things	Project N.	258666
	D4.3.2 – Report on IOT Living Labs Continuous Exploration and Evaluation (interim)	Date	17.09.2012

```

<GetTracerSerieResult tracerid="VM000">
  <metadata>
    <sensor-metadata id="gaz" name="Gaz sensor">
      <variables>
        <variable id="O3NO2" name="Concentration O2+N03" unit="PPM"/>
        <variable id="TEMP" name="Temperature" unit="°C"/>
        <variable id="HYGRO" name="Hygrometrie" unit=""/>
      </variables>
    </sensor-metadata>
    <sensor-metadata id="noise" name="Noise sensor">
      <variables>
        <variable id="DBA" name="DBA measure" unit="DB"/>
      </variables>
    </sensor-metadata>
  </metadata>
  <measure>
    <date>2012-09-06T00:00:00</date>
    <location lat="43.67505666666667" lon="7.228573333333333"/>
    <sensor type="gaz" values="70.00 24.20 56.00"/>
    <sensor type="noise" values="54.40"/>
  </measure>
  <measure>
    <date>2012-09-06T00:01:00</date>
    <location lat="43.67505666666667" lon="7.228573333333333"/>
    <sensor type="gaz" values="90.00 24.20 55.81"/>
    <sensor type="noise" values="53.35"/>
  </measure>
  .....
  <measure>
    <date>2012-09-06T06:20:00</date>
    <location lat="43.675361666666667" lon="7.228995"/>
    <sensor type="gaz" values="82.00 21.62 58.29"/>
    <sensor type="noise" values="61.12"/>
  </measure>
  <measure>
    <date>2012-09-06T06:21:00</date>
    <location lat="43.675361666666667" lon="7.228995"/>
    <sensor type="gaz" values="72.00 21.63 57.74"/>
    <sensor type="noise" values="59.81"/>
  </measure>
</GetTracerSerieResult>
</GetTracerSerieResponse>
</soap:Body>
</soap:Envelope>

```

8.3.4 Air quality POLLUX stations: FING (resp) + Inria

10 Pollux stations are planned: 3 (FING) and 7 (INRIA, out of ELLIOT budget)

8.3.4.1 Sensors

Due to higher acquisition costs (sensor change) from the manufacturer and due to a low precision of the CO sensor (0-300ppm ± 0.25 ppm) and NO₂ sensor (0-50ppm ± 0.05 ppm) on the POLLUX station, INRIA decided to order only PM₁₀ sensor plus temperature and noise and has ordered 7 stations instead of 10 initially. This is the same for FING: 3 stations instead of 7.

Table 51: Sensors involved in Air quality Pollox station

Temperature	-40°C à +100°C $\pm 0.2^\circ\text{C}$
PM ₁₀ , Dust	PM ₁₀ Filter 0-05 mg/m ³
Noise	db



Figure 54: Pollux green station (gateway module and sensors)

8.3.4.2 IoT connectivity

The green POLLUX station (from the Pollux'NZ City project) is composed on two modules: one for the sensors and one for the communication. IoT connectivity follows the sequence

	ELLIOT – Experiential Living Lab for the Internet Of Things	Project N.	258666
	D4.3.2 – Report on IOT Living Labs Continuous Exploration and Evaluation (interim)	Date	17.09.2012

outlined below:

1. The module wakes up the sensor module;
2. It requests the measures on sensor bus of the sensor module;
3. For each sensor, the sensor module sends measures values to the gateway module;
4. The gateway module saves the received data;
5. Then, after having received all the data, the gateway module turns in a sleeping mode;
6. The gateway module calls each data store extension with collected data;
7. The gateway module waits for the configured duration;
8. Return to 1.

The data store extensions are used for the data processing, mainly for sending the results to the data aggregation platform (in our case it is the green services or local services (such as CSV data collection)). These extensions are simple scripts written in Python (with some constraints regarding usable language features), one method for calling Pollux’NZ City application and a dictionary containing the default configurations.

Green services (v1): A python script (embedded in the Pollux station) pushes data to the green services (v1) raw data server using HTTP. Tests of this implementation are planned for the second week of September 2012.

8.3.5 Air quality AxIS device: INRIA (resp)

Figure 55 shows an AxIS air quality device: a two sensors station (interior air quality sensor and a PM10 sensor behind the window).

This air quality AxIS device is under study by INRIA. A decision whether to use such a backup station will be taken in September according to its precision quality and to the number of citizen sensors provided in time by the IoT providers.

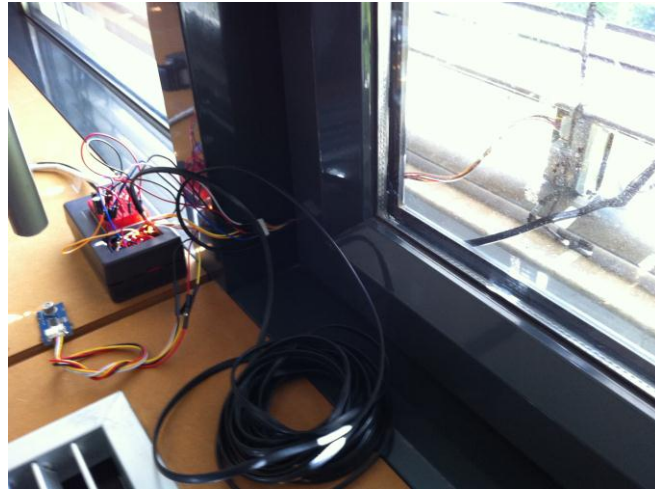







Figure 55: Example of an Axis arduino-based air quality station (2 sensors)

8.3.5.1 Sensors

The list below describes the various sensors INRIA (acquired out of ELLIOT budget) in order to test them in September and to compare them to the others sensors involved in green services and in case more citizen air quality stations are needed for ELLIOT experiments.

Table 52: Sensor overview

Description	Image
<p>Dust sensor :</p> <p>Measures the mg of micro-particle/m³ of air.</p> <p>*This sensor can be used indoors or outdoors</p>	
<p>Electret microphone (not receive at this time) :</p> <p>Measures the external noise</p> <p>*This sensor can be used indoors or outdoors</p>	
<p>Indoor air quality sensor :</p> <p>Measures a global air quality by different target gases</p> <p>*This sensor can be used only indoors</p>	

<p>Smoke sensor :</p> <p>Measures different gases, LPG, i-butane, propane, methane, alcohol, Hydrogen, smoke.</p> <p>*This sensor can be used indoors and outdoors but it must be powered 24 hours for preheating.</p>	
<p>Temperature sensor :</p> <p>Measures the temperature</p> <p>*This sensor can be used indoor or outdoor</p>	
<p>Light sensor :</p> <p>Measures the light exposure</p> <p>*This sensor can be used indoors or outdoors</p>	

8.3.5.2 IoT connectivity

All selected sensors can be plugged into an Arduino board. It is planned to upload a sketch into the board. This sketch gets the sensor data values and sends them via TCP/IP by using an Ethernet shield that is plugged on the Arduino Board.

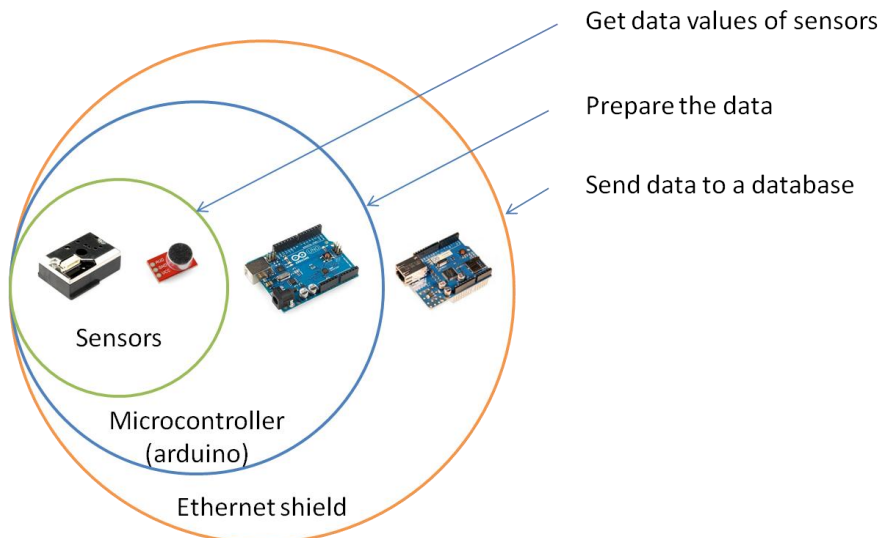



Figure 56 : Schema of sensors connected to an Arduino board that sends values via Ethernet shield

Now we have an independent object which gets data values of sensors connected to the Internet

	ELLIOT – Experiential Living Lab for the Internet Of Things	Project N.	258666
	D4.3.2 – Report on IOT Living Labs Continuous Exploration and Evaluation (interim)	Date	17.09.2012

and stores these data on the centralised database. Our object is referenced into the database with its sensors and sends its data every ‘x’ seconds or minutes. In addition, we have implemented a first interface on the server side to see the real time results of sensors.

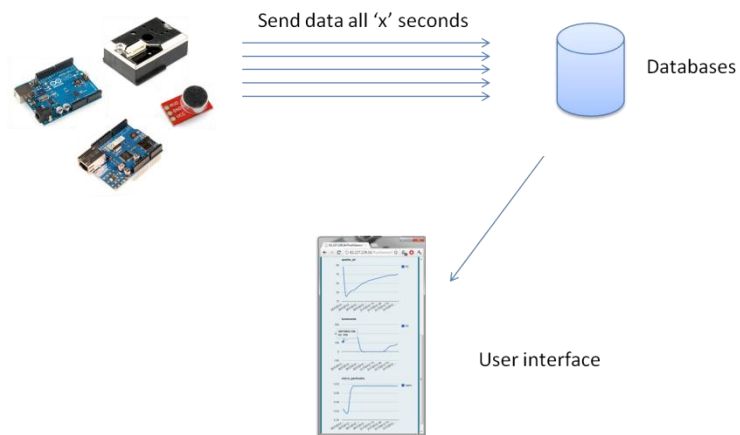



Figure 57 : Arduino sensors values send to database and first user interface

Green services (v1): From the PM10 sensor, IoT data (PM10) are pushed directly to the green services (v1) raw data server. Implementation and tests are done. A first interface for the manager of the green services use case related to IoT Data analysis is available.

	ELLIOT – Experiential Living Lab for the Internet Of Things	Project N.	258666
	D4.3.2 – Report on IOT Living Labs Continuous Exploration and Evaluation (interim)	Date	17.09.2012

9 Appendix: Logistics Use Case [BIBA]

9.1 Questionnaires

The following sections contain the briefing and debriefing questionnaires for the co-creation phase. The exploration questionnaires contain the same questions.

9.1.1 Briefing Questionnaire

<p>Questionnaire</p> <p>- ELLIOT Co-Creation -</p>
--

Information about data protection

All collected data will be treated strictly confidential and anonymous. At any imaginable utilization of this data it is excluded that you can be identified. We only keep anonymous records of data. Do not write your name down anywhere.

A Personal Data

1. age	<input type="text"/>	[years]
2. gender	<input type="checkbox"/> female <input type="checkbox"/> male	
3. specialty/field of study	<input type="text"/>	
4. experience (in the specialty named above)	<input type="text"/>	[years]
5. Please generate your own code and fill it in the top right gap of the page header.	<input type="checkbox"/> first letter of your birthplace	
	<input type="checkbox"/> last letter of your mother's first name	
	<input type="checkbox"/> first letter of your mother's first name	
	<input type="checkbox"/> last letter of your first name	

B Personal expectations for the workshop

	<i>During the workshop I expect to...</i>	---	--	-	-/+	+	++	+++
1	try out my own ideas.	<input type="checkbox"/>	<input type="checkbox"/>	<input type="checkbox"/>	<input type="checkbox"/>	<input type="checkbox"/>	<input type="checkbox"/>	<input type="checkbox"/>
2	get an insight into Internet of Things (IoT).	<input type="checkbox"/>	<input type="checkbox"/>	<input type="checkbox"/>	<input type="checkbox"/>	<input type="checkbox"/>	<input type="checkbox"/>	<input type="checkbox"/>
3	gain new skills.	<input type="checkbox"/>	<input type="checkbox"/>	<input type="checkbox"/>	<input type="checkbox"/>	<input type="checkbox"/>	<input type="checkbox"/>	<input type="checkbox"/>
4	change something	<input type="checkbox"/>	<input type="checkbox"/>	<input type="checkbox"/>	<input type="checkbox"/>	<input type="checkbox"/>	<input type="checkbox"/>	<input type="checkbox"/>
5	take an active role in the events.	<input type="checkbox"/>	<input type="checkbox"/>	<input type="checkbox"/>	<input type="checkbox"/>	<input type="checkbox"/>	<input type="checkbox"/>	<input type="checkbox"/>
6	other							

	ELLIOT – Experiential Living Lab for the Internet Of Things	Project N.	258666
	D4.3.2 – Report on IOT Living Labs Continuous Exploration and Evaluation (interim)	Date	17.09.2012

C Experience with IoT

		---	--	-	-/+	+	++	+++
1	I have experience with the application of IoT services.	<input type="checkbox"/>	<input type="checkbox"/>	<input type="checkbox"/>	<input type="checkbox"/>	<input type="checkbox"/>	<input type="checkbox"/>	<input type="checkbox"/>
2	I have experience with the development of IoT services.	<input type="checkbox"/>	<input type="checkbox"/>	<input type="checkbox"/>	<input type="checkbox"/>	<input type="checkbox"/>	<input type="checkbox"/>	<input type="checkbox"/>
3	I know and understand the technical background (sensors, actuators, logic) of an IoT service.	<input type="checkbox"/>	<input type="checkbox"/>	<input type="checkbox"/>	<input type="checkbox"/>	<input type="checkbox"/>	<input type="checkbox"/>	<input type="checkbox"/>

D Personal attitude regarding IoT

	<i>In my opinion...</i>	---	--	-	-/+	+	++	+++
1	IoT services can make day to day life easier.	<input type="checkbox"/>	<input type="checkbox"/>	<input type="checkbox"/>	<input type="checkbox"/>	<input type="checkbox"/>	<input type="checkbox"/>	<input type="checkbox"/>
2	IoT can generate services for logistics.	<input type="checkbox"/>	<input type="checkbox"/>	<input type="checkbox"/>	<input type="checkbox"/>	<input type="checkbox"/>	<input type="checkbox"/>	<input type="checkbox"/>
3	IoT services can increase the safety in logistics.	<input type="checkbox"/>	<input type="checkbox"/>	<input type="checkbox"/>	<input type="checkbox"/>	<input type="checkbox"/>	<input type="checkbox"/>	<input type="checkbox"/>
4	IoT services can offer relieve for employees in logistics.	<input type="checkbox"/>	<input type="checkbox"/>	<input type="checkbox"/>	<input type="checkbox"/>	<input type="checkbox"/>	<input type="checkbox"/>	<input type="checkbox"/>
5	other							

9.1.2 Debriefing Questionnaire

Questionnaire

- ELLIOT Co-Creation -

Information about data protection

Any collected data will be treated strictly confidential and anonymous. At any imaginable utilization of this data it is excluded that you can be identified. We only keep anonymous records of your generated data. Do not write your name down anywhere.

A Personal Data

6. age	<input type="text"/>	[years]
7. gender	<input type="checkbox"/> female <input type="checkbox"/> male	
8. specialty/field of study	<input type="text"/>	
9. experience (in the specialty named above)	<input type="text"/>	[years]
10. Please generate your own code and fill it in the top right gap of the page header.	<input type="checkbox"/>	first letter of your birthplace
	<input type="checkbox"/>	last letter of your mother's first name
	<input type="checkbox"/>	first letter of your mother's first name
	<input type="checkbox"/>	last letter of your first name

B Personal experience in the workshop

	<i>During the workshop I was able to...</i>	---	--	-	-/+	+	++	+++
1	try out my own ideas.	<input type="checkbox"/>	<input type="checkbox"/>	<input type="checkbox"/>	<input type="checkbox"/>	<input type="checkbox"/>	<input type="checkbox"/>	<input type="checkbox"/>
2	get an insight into Internet of Things (IoT).	<input type="checkbox"/>	<input type="checkbox"/>	<input type="checkbox"/>	<input type="checkbox"/>	<input type="checkbox"/>	<input type="checkbox"/>	<input type="checkbox"/>
3	gain new skills.	<input type="checkbox"/>	<input type="checkbox"/>	<input type="checkbox"/>	<input type="checkbox"/>	<input type="checkbox"/>	<input type="checkbox"/>	<input type="checkbox"/>
4	change something	<input type="checkbox"/>	<input type="checkbox"/>	<input type="checkbox"/>	<input type="checkbox"/>	<input type="checkbox"/>	<input type="checkbox"/>	<input type="checkbox"/>
5	take an active role in the events.	<input type="checkbox"/>	<input type="checkbox"/>	<input type="checkbox"/>	<input type="checkbox"/>	<input type="checkbox"/>	<input type="checkbox"/>	<input type="checkbox"/>
6	influence the decision making process actively.	<input type="checkbox"/>	<input type="checkbox"/>	<input type="checkbox"/>	<input type="checkbox"/>	<input type="checkbox"/>	<input type="checkbox"/>	<input type="checkbox"/>
7	other							

C Experience with IoT

	<i>Taking part in the workshop...</i>	---	--	-	-/+	+	++	+++
1	increased my interest in IoT applications.	<input type="checkbox"/>	<input type="checkbox"/>	<input type="checkbox"/>	<input type="checkbox"/>	<input type="checkbox"/>	<input type="checkbox"/>	<input type="checkbox"/>
2	increased my knowledge about IoT.	<input type="checkbox"/>	<input type="checkbox"/>	<input type="checkbox"/>	<input type="checkbox"/>	<input type="checkbox"/>	<input type="checkbox"/>	<input type="checkbox"/>
3	increased my experience in developing IoT services.	<input type="checkbox"/>	<input type="checkbox"/>	<input type="checkbox"/>	<input type="checkbox"/>	<input type="checkbox"/>	<input type="checkbox"/>	<input type="checkbox"/>

D Personal attitude regarding IoT

	<i>In my opinion...</i>	---	--	-	-/+	+	++	+++
1	IoT services can make day to day life easier.	<input type="checkbox"/>	<input type="checkbox"/>	<input type="checkbox"/>	<input type="checkbox"/>	<input type="checkbox"/>	<input type="checkbox"/>	<input type="checkbox"/>
2	IoT can generate services for logistics.	<input type="checkbox"/>	<input type="checkbox"/>	<input type="checkbox"/>	<input type="checkbox"/>	<input type="checkbox"/>	<input type="checkbox"/>	<input type="checkbox"/>
3	IoT services can increase the safety in logistics.	<input type="checkbox"/>	<input type="checkbox"/>	<input type="checkbox"/>	<input type="checkbox"/>	<input type="checkbox"/>	<input type="checkbox"/>	<input type="checkbox"/>
4	IoT services can offer relieve for employees in logistics.	<input type="checkbox"/>	<input type="checkbox"/>	<input type="checkbox"/>	<input type="checkbox"/>	<input type="checkbox"/>	<input type="checkbox"/>	<input type="checkbox"/>
5	other							

E Opinion of the workshop

		---	--	-	-/+	+	++	+++
1	The workshop was interesting.	<input type="checkbox"/>	<input type="checkbox"/>	<input type="checkbox"/>	<input type="checkbox"/>	<input type="checkbox"/>	<input type="checkbox"/>	<input type="checkbox"/>
2	The functions of the software could be understood easily.	<input type="checkbox"/>	<input type="checkbox"/>	<input type="checkbox"/>	<input type="checkbox"/>	<input type="checkbox"/>	<input type="checkbox"/>	<input type="checkbox"/>
3	The process of the development was comprehensible	<input type="checkbox"/>	<input type="checkbox"/>	<input type="checkbox"/>	<input type="checkbox"/>	<input type="checkbox"/>	<input type="checkbox"/>	<input type="checkbox"/>
4	The gathered results will support further development of IoT services in logistics.	<input type="checkbox"/>	<input type="checkbox"/>	<input type="checkbox"/>	<input type="checkbox"/>	<input type="checkbox"/>	<input type="checkbox"/>	<input type="checkbox"/>
5	I believe that the gathered results have the potential to lead to a relevant industrial service.	<input type="checkbox"/>	<input type="checkbox"/>	<input type="checkbox"/>	<input type="checkbox"/>	<input type="checkbox"/>	<input type="checkbox"/>	<input type="checkbox"/>
6	comments							

	ELLIOT – Experiential Living Lab for the Internet Of Things	Project N.	258666
	D4.3.2 – Report on IOT Living Labs Continuous Exploration and Evaluation (interim)	Date	17.09.2012

7	ideas for improvement
---	-----------------------