



HAL
open science

FeedNetBack - D05.04 - Design methodologies for event-based control systems

Nicolas Cardoso de Castro, Federica Garin, Carlos Canudas de Wit, Peter Hokayem, John Lygeros, Carlos Vivas, Pablo Millan, Luis Orihuela, Francisco Rubio, Ubaldo Tiberi, et al.

► **To cite this version:**

Nicolas Cardoso de Castro, Federica Garin, Carlos Canudas de Wit, Peter Hokayem, John Lygeros, et al.. FeedNetBack - D05.04 - Design methodologies for event-based control systems. [Research Report] 2011. hal-00785741

HAL Id: hal-00785741

<https://inria.hal.science/hal-00785741>

Submitted on 6 Feb 2013

HAL is a multi-disciplinary open access archive for the deposit and dissemination of scientific research documents, whether they are published or not. The documents may come from teaching and research institutions in France or abroad, or from public or private research centers.

L'archive ouverte pluridisciplinaire **HAL**, est destinée au dépôt et à la diffusion de documents scientifiques de niveau recherche, publiés ou non, émanant des établissements d'enseignement et de recherche français ou étrangers, des laboratoires publics ou privés.



GRANT AGREEMENT N°223866

Deliverable	Deliverable D05.04
Nature	Report
Dissemination	Public

D05.04 – Design methodologies for event-based control systems

Report Preparation Date 31/Aug/2011
Project month: 36

Authors: Nicolas Cardoso de Castro, Federica Garin, Carlos Canudas de Wit, INRIA, Peter Hokayem, John Lygeros, ETH, Carlos Vivas, Pablo Millán, Luis Orihuela, Francisco R. Rubio, US, Ubaldo Tiberi, Carlo Fischione, Karl H. Johansson, KTH

Report Version Vn 2
Doc ID Code INRIACO01_D0504_31082011_V2
Contract Start Date 01/SEP/2008
Duration 41 months
Project Coordinator : Carlos CANUDAS DE WIT, INRIA, France



Theme 3:

Information and Communication Technologies

SUMMARY

Networked Control Systems (NCS) are systems in which the sensors or/and the actuators communicate with the controller through a network. Energy saving and robustness to unreliable channels are major challenges in networked control, notably in wireless scenarios. Energy efficiency and in particular asynchronous design methodologies are studied in this deliverable. The presence of a channel between the sensors measuring the plant and the controller generating the control inputs implies that the measurements should be quantized. As a preliminary step, the problem of finding a stabilizing policy with quantized measurements and bounded control inputs is considered. It is common to assume that the different nodes of a Network Control System use a periodic synchronized clock, this simplifies the model which may take into account some transmission delays. However, this assumption is strong and energy consuming. Indeed, the periodic sampling time is often chosen to ensure given performance in the worst case scenario, wasting energy when the system is running around its working point. To relax the assumption of synchronized nodes, the rest of the deliverable introduces two asynchronous design methodologies, event-based and self-triggered methodologies. The former consists in limiting the transmissions between the nodes when a given condition holds, or, in other words, when an event occurs. Not only this approach relaxes the assumption of synchronized nodes, but it also limits the transmissions which save energy. In the following, event-based approach is applied to a feedback control case and an estimation case. However, by its nature, event-based approach forces the communicating node to watch for the occurrence of the triggering event. This is relaxed in self-triggered approach where each node decides, at the end of an action (*e.g.* measuring, transmitting, controlling), when the next action will take place. In between these times, the node usually goes to down mode to save energy. In the last part of this deliverable, this approach is applied to a variable sample rate control and to the case of IEEE 802.15.4 protocol.

Contents

1	Introduction	4
2	Control with Finite Alphabet and Bounded Inputs	6
2.1	Main Result	6
2.2	Example	8
3	Event-based design methodologies	12
3.1	Energy-aware wireless networked control using radio-mode management	12
3.1.1	Problem formulation	13
3.1.2	Solution of the optimization problem by Dynamic Programming	17
3.1.3	Simulation results	20
3.1.4	Conclusion and future work	23
3.2	Decentralized event-based observers for LTI networked systems	25
3.2.1	Problem description and motivation	25
3.2.2	Observers design	27
3.2.3	Simulation results	28
4	Self-triggered design methodologies	30
4.1	Variable sample rate control of systems subject to bounded disturbances	30
4.1.1	Problem formulation: continuous-time case	31
4.1.2	Problem formulation: discrete-time case	36
4.1.3	Performance	38
4.2	Adaptive Self-triggered Control over IEEE 802.15.4 Networks	40
4.2.1	IEEE 802.15.4 Control System Architecture	41
4.2.2	Self-triggered IEEE 802.15.4 NCSs	44
4.2.3	Simulations	49
4.2.4	Conclusions and Future Work	50
5	Conclusions	51

1 Introduction

This document summarizes the results obtained in four research lines related to energy efficiency and asynchronous design methodologies. Asynchronous approach relaxes the standard assumption that nodes in a Networked Control System (NCS) are synchronized, and moreover it is a technique used to limit the communications in the network. Reducing the transmissions has a direct effect on the energy consumption of each nodes and on the occupancy of the shared medium, which can improve the reliability by avoiding congestions or collisions. On the other hand, well-known results about design methodologies for classical control systems do not longer hold when the sampling instants are not periodic. In particular, stability of the closed-loop, or convergence of the plant estimation in the case of monitoring, is not obvious. And this is not only due to the lack of periodicity in the sampling times, also, the presence of an unreliable channel forces the measurements or/and the control inputs to be quantized, and it introduces packet dropouts and other disturbing effect (*e.g.* delays, collisions).

As an introducing step, the first part of this report considers the stabilization issue in presence of quantized measurements and bounded control inputs (ensuring energy efficiency), with reliable channel and periodic sampling time. This part addresses the design of a quantizer and the associated controller in order to ensure that the state of the plant is mean-square bounded. The measurements are quantized using a finite alphabet. Conditions on the quantizer and the controller are derived in order to obtain stability.

In the rest of the report, two asynchronous approaches are considered. The first one, called event-based, consists in transmitting measurements only when a given event occurs. Sensor nodes keep measuring the plant state periodically, but they only send the measurement if a given condition is satisfied, for instance, if the error between the measurements and the prediction (if assuming that a predictor is used when no transmission occurs) is beyond a given threshold. The event-based approach is first used in a control scenario where a sensor node measures the state of an unstable linear time invariant plant, and decides to send the measurement to the controller node only if the state is outside a given region. The novelty of this contribution resides in the modelization of low consuming radio modes, *i.e.* the radio chip of the sensor node is not only consider ON or OFF, it may also take indermediate states, *e.g.* Idle. The switching policy between these different modes (or, in other words the regions in the state space where each radio mode should be used) is derived using Dynamic Programming, and it considers a cost function to tradeoff control performance and the energy consumption. The derived switching policy is optimal.

The event-based approach is then used in a different scenario, a decentralized event-based observer strategy for networked systems. The method assumes a number of estimating nodes sensing the evolution of a given plant. The objective consists in building an event-based estimation strategy of the plant states, based on the local measurements of every node. The methodology is based on local Luenberger-like observers in combination with a consensus strategy. The main contribution of this work lies in the fact of providing a bandwidth-aware procedure for distributed estimation of large scale processes.

The second asynchronous approach considered in this report is the so-called self-triggered approach. While the sensor node measures the plant state periodically in the event-based approach and only limit the amount of communication, in the self-triggered approach, the node goes to down mode between the transmitting processes. In this approach, when a node wake up, it proceeds the required actions, like sensing the plant and sending the measurement to the controller, and it also compute the next waking up instant to meet some performance requirements. This induces wake up instant that are neither period-

ically nor based on the occurrence of an external event. In particular, a control strategy for Networked Control Systems subject to norm-bounded disturbances is proposed. The main novelty of the method lies in the fact that the sampling time is dynamically scheduled to minimize network access (or maximize sampling period) as the process evolves. It is shown that the problem can be cast into a standard Quadratic Problem (QP), so tractable algorithms can be implemented.

In a second contribution, the self-triggered approach is applied to a state feedback control of a continuous linear perturbed system with parameter uncertainties. A self-triggering condition is derived to ensure local ε -practical stability. The results are then applied to a real wireless protocol suited for NCSs, IEEE 802.15.4. Finally, to save further energy, a distributed algorithm is derived to adapt the parameters of the protocol to dynamically change the duration of the beacon interval in relation with the triggering condition in order to maximize the time spent in the power down mode.

2 Control with Finite Alphabet and Bounded Inputs

Recently the stabilizability in the mean-square sense of a discrete-time linear system subject to unbounded random disturbance has been investigated in (Ramponi, Chatterjee, Miliadis-Argeitis, Hokayem and Lygeros 2010). Namely, given a linear system $x_{t+1} = Ax_t + Bu_t + w_t$, where (A, B) is a stabilizable pair, $(u_t)_{t \in \mathbb{N}_0}$ is a bounded control signal ($\|u_t\| \leq U_{\max}$ for all t), and $(w_t)_{t \in \mathbb{N}_0}$ is a sequence of independent random vectors, we have shown that with an appropriate choice of the control strategy it is possible to attain mean-square boundedness of the state process (i.e., $\sup_{t \geq 0} \mathbb{E}[\|x_t\|^2] \leq \infty$), provided that $(w_t)_{t \in \mathbb{N}_0}$ has bounded fourth-order moment; of course this requirement is more general than the requirement that $(w_t)_{t \in \mathbb{N}_0}$ is itself bounded, which is the standard assumption in robust control. The reader is referred to our articles (Ramponi et al. 2010) and (Chatterjee, Ramponi, Hokayem and Lygeros 2011), which deal with the case when full-state information is available; the more recent article (Hokayem, Cinquemani, Chatterjee, Ramponi and Lygeros 2010) treats this subject in greater generality and establishes the result by means of a receding-horizon strategy. Moreover, stabilization of linear systems with quantized state measurements has a rich history, see, for example, (Delchamps 1990, Nair, Fagnani, Zampieri and Evans 2007, Brockett and Liberzon 2000, Elia and Mitter 2002, Tatikonda, Saha and Mitter 2004, Yüksel 2010, Heemels and van de Wouw 2011, Hespanha, Naghshtabrizi and Xu 2007, Tupsuwan and Chow 2003, Yang 2006, Matveev and Savkin 2007, Matveev and Savkin 2009).

In what follows, we extend the results above to the Networked Control Systems (NCS) setting in which high energy efficiency is required. The state information must be encoded using a finite alphabet and transmitted to the controller. The controller utilizes this limited information in order to issue bounded actuation commands that ensure that the state remains mean-square bounded. Ensuring mean-square boundedness under unbounded noise, a highly nontrivial task even with full-state information, is still possible even if state information is only available in quantized form. We show that in essence the information relevant for ensuring mean square boundedness is encoded in the direction of the state vector. We therefore start by constructing a finite partition (a set of “bins”) of the set of all possible directions. Based on this finite quantizer we then develop a time-varying policy as a concatenation of a κ -length policy $(u_{\kappa t}, u_{\kappa t+1}, \dots, u_{(\kappa+1)t-1})$, which depends only on the “bin” in which the state happens to fall at times κt ; note that as a consequence the control actions can take only a finite number of values as well. We show that, under suitable assumptions on the control bound U_{\max} and on the maximum size of the bins (and as a consequence their number), this policy ensures mean-square boundedness of the states. Finally, we test our result on a simple system; remarkably, the proposed control strategy appears to be reasonably effective even when the theoretical hypotheses are violated.

2.1 Main Result

Consider the linear control system

$$x_{t+1} = Ax_t + Bu_t + w_t, \quad x_0 \text{ given}, \quad t = 0, 1, \dots, \quad (2.1)$$

where $x_t \in \mathbb{R}^n$ is the vector of states, $u_t \in \mathbb{R}^m$ is the vector of control actions, $(w_t)_{t \in \mathbb{N}_0}$ is a zero-mean sequence of noise vectors, and A and B are matrices of appropriate dimensions. It is assumed that instead of perfect measurements of the state, quantized state measurements are available by means of a quantizer $q : \mathbb{R}^n \rightarrow Q$, where $Q \subset \mathbb{R}^n$ is a finite set of vectors in \mathbb{R}^n which we will refer to as “bins”.

Our objective is to construct a quantizer and a corresponding control policy such that the magnitude of the control is *uniformly bounded*, (i.e., for some $U_{\max} > 0$ we have $\|u_t\| \leq U_{\max}$ for all t), the number of bins Q is *finite*, and the state of (2.1) is *mean-square bounded* (, i.e., $\sup_{t \in \mathbb{N}_0} \mathbb{E}_{x_0} [\|x_t\|^2] < \infty$), in closed-loop.

Assumption 2.1.

- The matrix A is Lyapunov stable—the eigenvalues of A have magnitude at most 1, and those on the unit circle have equal geometric and algebraic multiplicities.
- The pair (A, B) is reachable in κ steps, i.e., $\text{rank} \begin{pmatrix} B & AB & \cdots & A^{\kappa-1}B \end{pmatrix} = n$.
- $(w_t)_{t \in \mathbb{N}_0}$ is a zero mean sequence of mutually independent noise vectors satisfying $C_4 := \sup_{t \in \mathbb{N}_0} \mathbb{E} [\|w_t\|^4] < \infty$.
- $\|u_t\| \leq U_{\max}$ for all $t \in \mathbb{N}_0$.

The policy that we construct below belongs to the class of κ -history-dependent policies, where the history is that of the quantized states. We refer the reader to our earlier article (Ramponi et al. 2010) for the basic setup, various definitions, and in particular to (Ramponi et al. 2010, §3.4) for the details about a change of basis in \mathbb{R}^n that shows that it is sufficient to consider A orthogonal. We let $\mathcal{R}_\kappa(A, M) := \begin{pmatrix} A^{\kappa-1}M & \cdots & AM & M \end{pmatrix}$ for a matrix M of appropriate dimension, M^\dagger denote the Moore-Penrose pseudoinverse of M (when it exists), and $\sigma_{\min}(M), \sigma_{\max}(M)$ denote the minimal and maximal singular values of M , respectively. I denotes the $d \times d$ identity matrix. For a vector $v \in \mathbb{R}^n$, let $\Pi_v(\cdot) := \left\langle \cdot, \frac{v}{\|v\|} \right\rangle \frac{v}{\|v\|}$ and $\Pi_v^\perp(\cdot) := I - \Pi_v(\cdot)$ denote the projections onto the span of v and its orthogonal complement, respectively. For $r > 0$ let the radial r -saturation function $\text{sat}_r : \mathbb{R}^n \rightarrow \mathbb{R}^n$ be defined as $\text{sat}_r(y) := \min\{r, \|y\|\} \frac{y}{\|y\|}$, and let $B_r \subset \mathbb{R}^n$ denote the open r ball centered at 0 and ∂B_r denote its boundary. We have the following theorem:

Theorem 2.2. Consider the system (2.1), and suppose that Assumption 2.1 holds. Assume that the quantizer is such that there exists a constant r satisfying:

- a) $r > \frac{\sqrt{\kappa} \sigma_{\max}(\mathcal{R}_\kappa(A, I)) \sqrt[4]{C_4}}{\cos(\varphi) - \sin(\varphi)}$, where $\varphi \in [0, \pi/4[$ is the maximal angle between z and $\mathbf{q}(z)$, $z \notin B_r$, and
- b) $\mathbf{q}(z) = \mathbf{q}(\text{sat}_r(z)) \in \partial B_r$ for every $z \notin B_r$.

Finally assume that $U_{\max} \geq r / \sigma_{\min}(\mathcal{R}_\kappa(A, B))$. Then successive κ -step applications of the control policy

$$\left(u_{\kappa t}^\top \cdots u_{\kappa(t+1)-1}^\top \right)^\top := -\mathcal{R}_\kappa(A, B)^\dagger A^\kappa \mathbf{q}(x_{\kappa t}), \quad t \in \mathbb{N}_0, \quad (2.2)$$

ensures that $\sup_{t \in \mathbb{N}_0} \mathbb{E}_{x_0} [\|x_t\|^2] < \infty$.

Observe that Theorem 2.2 outlines a procedure for constructing a quantizer with finitely many bins, an example of which on \mathbb{R}^2 is depicted in Figure 1. We see from the hypotheses of Theorem 2.2 that the quantizer has no large gap between the bins on the r -sphere, and is “radial”; the quantization rule for the states inside B_r does not matter insofar as mean-square boundedness of the states is concerned. As a consequence of the control policy in Theorem 2.2, the control alphabet is also finite with $\kappa|Q|$

elements.¹ Moreover, note that as $\varphi \searrow 0$, i.e., as the “density” of the bins on the r -sphere increases, we recover the lower bound on U_{\max} in (Ramponi et al. 2010).²

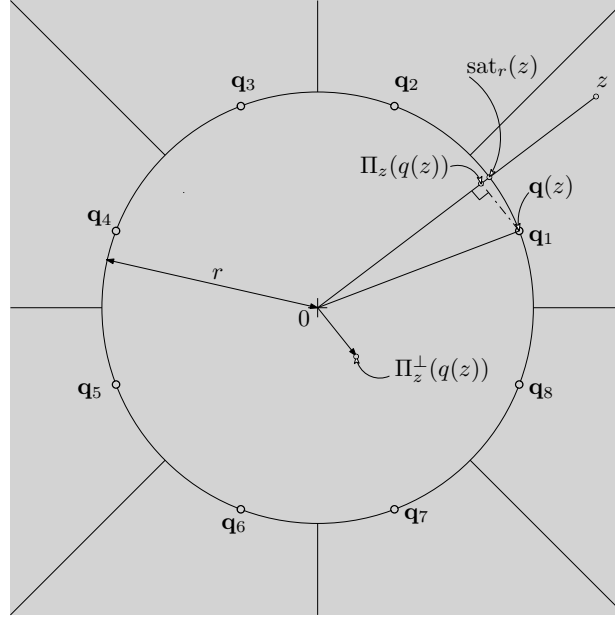

Figure 1. Pictorial depiction of the proposed quantization scheme in \mathbb{R}^2 , with $\{q_0 = 0, q_1, \dots, q_8\}$ being the set of bins. The various projections are computed for a generic state z outside the r -ball centered at the origin.

2.2 Example

As a very simple example, we consider the system

$$x_{t+1} = \begin{pmatrix} \cos(\pi/3) & -\sin(\pi/3) \\ \sin(\pi/3) & \cos(\pi/3) \end{pmatrix} x_t + \begin{pmatrix} 1 \\ 0 \end{pmatrix} u_t + w_t,$$

where $x_0 = (10 \ 10)^\top$ and $w_t \in \mathcal{N}(0, I)$. Here, $\kappa = 2$, $\sigma_{\max}(\mathcal{R}_\kappa(A, I)) = \sqrt{2}$, $C_4 = \mathbb{E}[\|w_t\|^4] = \mathbb{E}[(\chi^2(2))^2] = 8$, and $\sigma_{\min}(\mathcal{R}_\kappa(A, B)) = \frac{\sqrt{2}}{2}$, hence the assumptions of Theorem 2.2 read:

$$r > \frac{\sqrt{2}\sqrt{2}\sqrt[4]{8}}{\cos(\varphi) - \sin(\varphi)}$$

$$r \leq U_{\max} \frac{\sqrt{2}}{2}$$

¹Since the number of orthants grows exponentially with n (the dimension of x) and since $\varphi \in [0, \pi/4]$, the number of bins also increases at least exponentially with n .

²Indeed, from condition a) of Theorem 2.2 we see that $(\cos \varphi - \sin \varphi) \rightarrow 1$ as $\varphi \rightarrow 0$.

We choose (arbitrarily) the number of bins to be 8, and the quantized point to be located on the bisecting axis of each bin (exactly as in figure 1); then $\varphi = \frac{\pi}{8}$, and we obtain

$$r > \frac{2\sqrt{2}}{0.54} = 6.22$$

$$U_{\max} \geq \sqrt{2}r > 8.8$$

Figure 2 shows the average of the square norm of the state over 1000 runs of the above system under the quantized policy. The result is compared with a similar policy, with the same control authority U_{\max} but with a lower number of bins: The hypotheses of our main Theorem are violated, but the controller seems to work anyway. The results are also compared with the policy proposed in (Ramponi et al. 2010). Evidence from other simulations show that the policy of this paper works for lower control authorities as well.

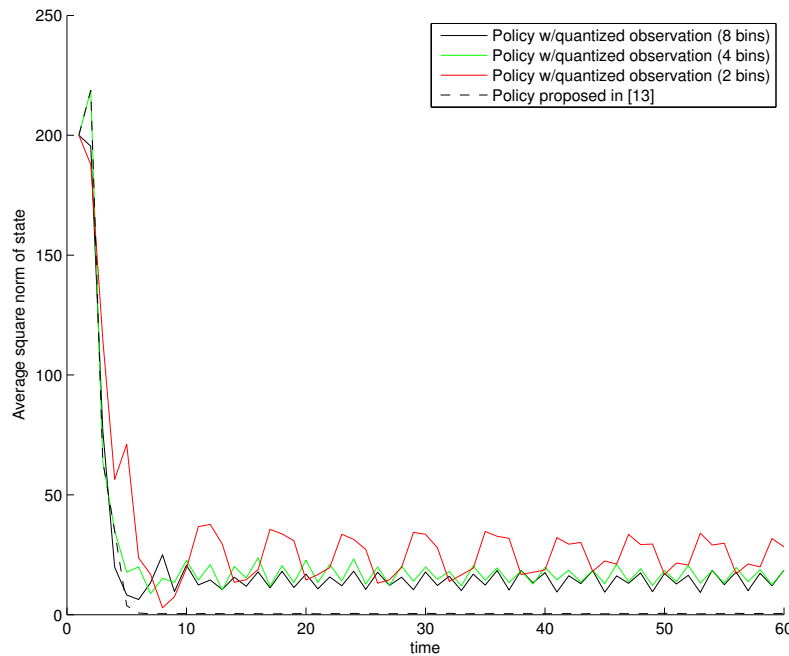

Figure 2. Empirical average of the square norm of the state under various quantization choices versus the policy in (Ramponi et al. 2010).

Appendix

We assume that the random variables w_t are defined on some probability space (Ω, \mathcal{F}, P) . Hereafter $E^{\mathcal{F}'}[\cdot]$ denotes conditional expectation for a σ -algebra $\mathcal{F}' \subset \mathcal{F}$. We need the following immediate consequence of (Pemantle and Rosenthal 1999, Theorem 1).

Proposition 2.3. Let $(\xi_t)_{t \in \mathbb{N}_0}$ be a sequence of nonnegative random variables on some probability space $(\Omega, \mathcal{F}, \mathbb{P})$, and let $(\mathcal{F}_t)_{t \in \mathbb{N}_0}$ be any filtration to which $(\xi_t)_{t \in \mathbb{N}_0}$ is adapted. Suppose that there exist constants $b > 0$, and $J, M < \infty$, such that $\xi_0 \leq J$, and for all t :

$$\begin{aligned} \mathbb{E}^{\mathcal{F}_t}[\xi_{t+1} - \xi_t] &\leq -b \quad \text{on the event } \{\xi_t > J\}, \quad \text{and} \\ \mathbb{E}[|\xi_{t+1} - \xi_t|^4 | \xi_0, \dots, \xi_t] &\leq M. \end{aligned}$$

Then there exists a constant $\gamma = \gamma(b, J, M) > 0$ such that $\sup_{t \in \mathbb{N}_0} \mathbb{E}[\xi_t^2] \leq \gamma$.

Proof of Theorem 2.2: Let \mathcal{F}_t be the σ -algebra generated by $\{x_s \mid s = 0, \dots, t\}$. Since \mathbf{q} is a measurable map, it is clear that $(\mathbf{q}(x_t))_{t \in \mathbb{N}_0}$ is $(\mathcal{F}_t)_{t \in \mathbb{N}_0}$ -adapted.

We have, for $t \in \mathbb{N}_0$, on $\{\|x_{\kappa t}\| > r\}$,

$$\mathbb{E}^{\mathcal{F}_{\kappa t}} \left[\left\| x_{\kappa(t+1)} \right\| - \|x_{\kappa t}\| \right] = \mathbb{E}^{\mathcal{F}_{\kappa t}} \left[\left\| A^\kappa x_{\kappa t} + \mathcal{R}_\kappa(A, B) \bar{u}_{\kappa t} + \bar{w}_{\kappa t} \right\| - \|x_{\kappa t}\| \right],$$

where $\bar{u}_{\kappa t} := (u_{\kappa t}^\top, \dots, u_{\kappa(t+1)-1}^\top)^\top \in \mathbb{R}^{\kappa m}$, and $\bar{w}_{\kappa t} := \mathcal{R}_\kappa(A, I)(w_{\kappa t}^\top, \dots, w_{\kappa(t+1)-1}^\top)^\top$ is zero mean noise. It follows that

$$\begin{aligned} \mathbb{E}^{\mathcal{F}_{\kappa t}} \left[\left\| A^\kappa x_{\kappa t} + \mathcal{R}_\kappa(A, B) \bar{u}_{\kappa t} + \bar{w}_{\kappa t} \right\| - \|x_{\kappa t}\| \right] &\leq \mathbb{E}^{\mathcal{F}_{\kappa t}} \left[\left\| A^\kappa x_{\kappa t} + \mathcal{R}_\kappa(A, B) \bar{u}_{\kappa t} \right\| - \|x_{\kappa t}\| \right] \\ &\quad + \sqrt{\kappa} \sigma_{\max}(\mathcal{R}_\kappa(A, I)) \sqrt[4]{C_4}. \end{aligned}$$

Selecting the controls $\bar{u}_{\kappa t} = -\mathcal{R}_\kappa(A, B)^\dagger A^\kappa \mathbf{q}(x_{\kappa t})$ as in (2.2) and using the fact that $\mathbf{q}(x_{\kappa t}) = \Pi_{x_{\kappa t}}(\mathbf{q}(x_{\kappa t})) + \Pi_{x_{\kappa t}}^\perp(\mathbf{q}(x_{\kappa t}))$, we arrive at

$$\begin{aligned} &\mathbb{E}^{\mathcal{F}_{\kappa t}} \left[\left\| x_{\kappa(t+1)} \right\| - \|x_{\kappa t}\| \right] \\ &\leq \left\| A^\kappa x_{\kappa t} - A^\kappa \mathbf{q}(x_{\kappa t}) \right\| - \|x_{\kappa t}\| + \sqrt{\kappa} \sigma_{\max}(\mathcal{R}_\kappa(A, I)) \sqrt[4]{C_4} \\ &= \left\| x_{\kappa t} - \mathbf{q}(x_{\kappa t}) \right\| - \|x_{\kappa t}\| + \sqrt{\kappa} \sigma_{\max}(\mathcal{R}_\kappa(A, I)) \sqrt[4]{C_4} \quad \text{since } A \text{ is orthogonal} \\ &\leq \left\| x_{\kappa t} - \text{sat}_r(x_{\kappa t}) \right\| - \|x_{\kappa t}\| + \left\| \text{sat}_r(x_{\kappa t}) - \mathbf{q}(x_{\kappa t}) \right\| + \sqrt{\kappa} \sigma_{\max}(\mathcal{R}_\kappa(A, I)) \sqrt[4]{C_4} \\ &= \left\| x_{\kappa t} - \text{sat}_r(x_{\kappa t}) \right\| - \|x_{\kappa t}\| + \left\| \text{sat}_r(x_{\kappa t}) - \Pi_{x_{\kappa t}}(\mathbf{q}(x_{\kappa t})) - \Pi_{x_{\kappa t}}^\perp(\mathbf{q}(x_{\kappa t})) \right\| \\ &\quad + \sqrt{\kappa} \sigma_{\max}(\mathcal{R}_\kappa(A, I)) \sqrt[4]{C_4} \\ &\leq -r + \left\| \text{sat}_r(x_{\kappa t}) - \Pi_{x_{\kappa t}}(\mathbf{q}(x_{\kappa t})) \right\| + \left\| \Pi_{x_{\kappa t}}^\perp(\mathbf{q}(x_{\kappa t})) \right\| + \sqrt{\kappa} \sigma_{\max}(\mathcal{R}_\kappa(A, I)) \sqrt[4]{C_4} \\ &\leq -r + r(1 - \cos(\varphi)) + r \sin(\varphi) + \sqrt{\kappa} \sigma_{\max}(\mathcal{R}_\kappa(A, I)) \sqrt[4]{C_4} \\ &\leq -b \quad \text{for some } b > 0 \text{ by hypothesis a).} \end{aligned}$$

The vector $\bar{u}_{\kappa t}$ in (2.2) satisfies

$$\|\bar{u}_{\kappa t}\| \leq \left\| \mathcal{R}_\kappa(A, B)^\dagger \right\| \|A^\kappa\| \|\mathbf{q}(x_{\kappa t})\| \leq r / \sigma_{\min}(\mathcal{R}_\kappa(A, B)) \leq U_{\max}.$$

Since $\mathbb{E}[\|w_t\|^4] \leq C_4$ for each t and since A is orthogonal, we see that for $t \in \mathbb{N}_0$,

$$\begin{aligned} \mathbb{E}\left[\left|\|x_{\kappa(t+1)}\| - \|x_{\kappa t}\|\right|^4 \mid \{ \|x_{\kappa s}\| \}_{s=0}^t\right] &= \mathbb{E}\left[\left|\|x_{\kappa(t+1)}\| - \|A^\kappa x_{\kappa t}\|\right|^4 \mid \{ \|x_{\kappa s}\| \}_{s=0}^t\right] \\ &= \mathbb{E}\left[\left\|A^\kappa x_{\kappa t} + \mathcal{R}_\kappa(A, B)\bar{u}_{\kappa t} + \mathcal{R}_\kappa(A, I)\bar{w}_{\kappa t}\right\| - \|A^\kappa x_{\kappa t}\|\right|^4 \mid \{ \|x_{\kappa s}\| \}_{s=0}^t\right] \\ &\leq \mathbb{E}\left[\left\|\mathcal{R}_\kappa(A, B)\bar{u}_{\kappa t} + \mathcal{R}_\kappa(A, I)\bar{w}_{\kappa t}\right\|^4 \mid \{ \|x_{\kappa s}\| \}_{s=0}^t\right] \leq M \end{aligned}$$

for some $M > 0$.

It remains to define $\xi_t := \|x_{\kappa t}\|$ and appeal to Proposition 2.3 with the above definition of $(\xi_t)_{t \in \mathbb{N}_0}$ to conclude that there exists some $\gamma > 0$, depending on r , x_0 , b , and M , such that $\sup_{t \in \mathbb{N}_0} \mathbb{E}[\xi_t^2] = \sup_{t \in \mathbb{N}_0} \mathbb{E}_{x_0}[\|x_{\kappa t}\|^2] \leq \gamma$. A standard argument, e.g., as in (Ramponi et al. 2010, Proof of Lemma 9), shows that this is enough to guarantee $\sup_{t \in \mathbb{N}_0} \mathbb{E}_{x_0}[\|x_t\|^2] \leq \gamma'$ for some $\gamma' > 0$. \square

3 Event-based design methodologies

3.1 Energy-aware wireless networked control using radio-mode management

Networked Control Systems (NCS) are systems in which the sensors or/and the actuators communicate with the controller through a network. Energy saving and robustness to data loss are major challenges in wireless control, addressed by both communication and control communities. The survey paper (Cardoso de Castro, Canudas de Wit and Johansson 2010) draws the conclusion that the radio chip is the main energy consumer in a node and that communication and control co-design is essential to save large amount of energy. Authors in (Liu and Goldsmith 2004) also point out that co-design increases control performance in delayed and lossy environments.

Deep interest has been devoted to intermittent estimation and control, *i.e.* estimation or control problems where the measurements may not be available at some undetermined time because the sensor node switches off to save energy. Author in (Cogill 2009) derives a policy to decide when to send measurements to the controller (or control input to the plant in the case this link is more costly) and the optimal associated state-feedback. The event-based policy derived is less efficient than a fixed policy sending more information, but more efficient than a random policy sending the same amount of samples. Authors in (Imer and Basar 2006) consider a different setup where the controller has to choose between either measuring the plant or controlling it. They derive an off-line policy using an optimal control framework. Under quadratic cost function, the optimal choice appears to be a linear threshold between controlling and measuring. Instead of turning off the sensor node to save energy, the emission power of the radio chip can be increased to face bad channel conditions, or decreased to save energy. This is implemented in a MPC controller in (Quevedo and Ahlen 2008). Also, the topic of intermittent estimation is widely addressed, see *e.g.* (Cogill, Lall and Hespanha 2007, Imer and Basar 2005, Sinopoli, Schenato, Franceschetti, Poolla, Jordan and Sastry 2004, Xu and Hespanha 2005).

On the other hand, the communication literature investigates energy saving by switching off only some parts of the node, introducing the notion of energy mode management. While some contributions address setups where entire features of the node (computation, communication, sensing) are turned off (see *e.g.* (Sinha and Chandrakasan 2001)), we restrict our attention to the case where only the radio chip is switched to low consuming modes, turning off some components, such as the frequency synthesizer, the crystal oscillator, or the voltage regulator within the radio chip (see (Brownfield, Fayez, Nelson and Davis 2006)). Time issue is the main motivation to use low consuming radio-modes in (Brownfield et al. 2006): these modes take less time to wake up than the deepest sleep mode, allowing to save energy during narrow time window, at the communication protocol level. However, our approach consists in investigating how to save energy at the application level, where we consider the radio-mode transitions as instantaneous, since the transition delays are negligible with respect to the sampling time of our control application. Energy issue is then our main motivation. Indeed, although intermediate modes consume less energy, the energy needed to switch between modes may result in more wastes than savings. Deriving a switching policy that ensures good control performance and energy savings is not trivial. On the one hand, works considering mode management (*e.g.* (Sinha and Chandrakasan 2001, Brownfield et al. 2006)) do not address control problems, and on the other hand, works dealing with intermittent control only assume that the radio is either awake or asleep.

The main contribution of this paper is to consider intermediate radio-modes and their energy transition costs in a control problem, limited to 2 nodes for simplicity. Not only the sensor node should decide

whether transmitting or not, but also when not transmitting, it should decide which of the low consuming modes to switch to.

A switched linear system taking into account several radio-modes and the control application is derived in Section 3.1.1. An optimal switching policy, computed using Dynamic Programming, is presented in Section 3.1.2. Simulation results are provided in Section 3.1.3 and Section 3.1.4 concludes the paper and gives future directions.

3.1.1 Problem formulation

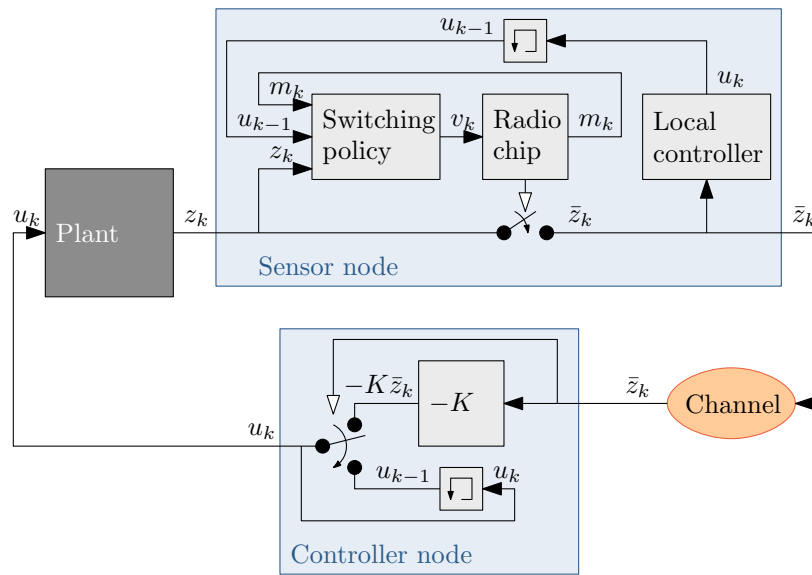

Figure 3. Block diagram of the problem setup. The sensor node measures the state z_k from the plant and decides whether to send it or not to the controller node. \bar{z}_k is equal to z_k when a transmission occurs, or to \emptyset otherwise. The controller is then able to determine if a transmission has occurred or not.

Setup description We consider a wireless networked control problem composed of two nodes, as depicted in Fig. 3 and described hereafter. The first node is in charge of sensing the plant’s output and deciding whether or not to send its measurement to the second node, in charge of controlling the plant. The aim of this paper is to save energy at the sensor’s radio chip level when the quality of the feedback control is good enough. The radio chip is switched to low consuming modes (e.g. Idle, OFF) to save energy. We are not interested here in the consumption of the second node as we assume that it is co-located with the actuator, and then it has access to an unlimited energy source. Also, the channel is considered as perfect in the model, even though we show in simulation that our solution is robust to measurement drop-outs.

We define N as the number of radio-modes. The switching decision is denoted by $v_k \in \{1, 2, \dots, N\}$, where $v_k = i$ means that the radio-mode is switched to mode i at time k .

Plant model The plant we control is a linear unstable discrete-time observable system, described by Eq. (3.1).

$$z_{k+1} = Az_k + Bu_k, z_k \in \mathbb{R}^n, u_k \in \mathbb{R}^p. \quad (3.1)$$

Control law The control input applied to the plant depends on the measurement arrivals, as described in Eq. (3.2). If the sensor decides to send the plant state, then the control law is a state feedback with gain K . This gain is chosen so that the system $z_{k+1} = (A - BK)z_k$ is stable. Otherwise, the control input is held to its previous value as long as no new measure is received from the sensor.

$$u_k = \begin{cases} -Kz_k & \text{if } z_k \text{ is available,} \\ u_{k-1} & \text{otherwise.} \end{cases} \quad (3.2)$$

Radio chip model The radio chip is characterized by the number of radio-modes, N , and the associated costs to stay in a given mode or to switch from a mode to another. We do not consider mode transition delay, assuming that the time scale of the control application is slow enough with respect to the transition delays.

The first radio-mode (generally called the ON mode) is the only one allowing transmission/reception, and the most consuming one. The other modes are intermediate modes where only some components of the radio are turned off, consuming less energy than the ON mode. The last radio-mode (called the OFF mode) consumes no or little energy (less than any other mode), but more time and/or energy are needed to switch to the ON mode from the OFF mode than from the intermediate modes. We define θ_{ij} as the energy needed to switch from the i^{th} mode to the j^{th} one, and θ_i as the energy to stay in the i^{th} mode. This is illustrated on Fig. 4 in the case where $N = 3$.

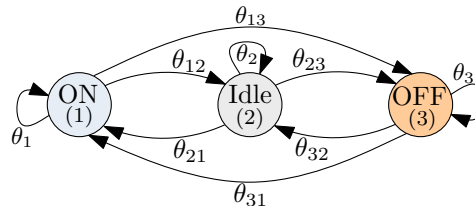

Figure 4. Illustration of the transitions costs. Idle represents an intermediate mode between ON and OFF. The θ_{ij} represent the energy costs associated to the transition from mode i to mode j and θ_i the cost to stay in mode i .

The state of the radio chip is the mode at time k , m_k :

$$m_k \in \mathbb{M} := \left\{ \underbrace{1}_{\text{ON}}, \underbrace{2, \dots, N}_{\text{intermediate}}, \underbrace{\quad}_{\text{OFF}} \right\},$$

and we define $\mathbb{M}^* := \{2, 3, \dots, N\}$.

The consumption of the radio chip at each sampling time depends on the radio-mode m_k and on the switching decision v_k . The amount of energy E consumed since the commissioning (where $E_0 = 0$) can

be computed as follows:

$$E_{k+1} = E_k + \theta_{m_k} v_k.$$

Sensor model The sensor node embeds a switching policy η (whose design is the goal of this paper) to assign the radio-mode. The decision to switch between modes is based on the actual plant output z_k , the last control input u_{k-1} and the current mode m_k : the switching decision is $v_k = \eta(z_k, u_{k-1}, m_k)$. The radio-mode is updated according to the switching decision: $m_{k+1} = v_k$. Note that the sensor node must have access to the last control input. One way to achieve this, as depicted in Fig. 3, is to embed in the sensor node the same control law than the one in the controller node. It is called “Local controller” in the sensor node on Fig. 3. Another possibility is to allow the control node to send back the control input to the sensor node. A third setup consists in a sensor node which computes u_k and sends it (instead of z_k) to the controller which then is limited to an holder updating its value whenever a new one is available.

Switched system formulation and optimization problem We formulate the evolution of the plant under the different choices of radio-modes as a switched linear system, with as many systems as the number of modes N . The evolution of the switched system depends on z_k , the state of the plant, on \bar{u}_k , a memory keeping track of the last applied control input, and on m_k the mode of the radio chip. We define ζ_k as the plant state augmented with the control memory: $\zeta_k = \begin{bmatrix} z_k \\ \bar{u}_k \end{bmatrix} \in \mathbb{R}^{n+p}$. The state of the switched system is then $x_k = (\zeta_k, m_k) \in \mathbb{X} = \mathbb{R}^{n+p} \times \mathbb{M}$.

The evolution of the plant given in Eq. (3.1) and the control law described in Eq. (3.2), together with the radio-mode update law η , give rise to the following switched system:

$$\begin{aligned} x_{k+1} &= f_{v_k}(x_k) \\ v_k &= \eta(x_k), \end{aligned}$$

where the function f_v is defined as:

$$f_{v_k}((\zeta_k, m_k)) = (\Phi_{v_k} \zeta_k, v_k), \quad (3.3)$$

and the matrices Φ_{v_k} , for $v_k \in \mathbb{M}$, are as follows:

1. if $v_k = 1$, *i.e.*, if there is a transmission, then:

$$\Phi_1 = \Phi = \begin{bmatrix} A - BK & 0 \\ -K & 0 \end{bmatrix}; \quad (3.4)$$

2. if $v_k = j \neq 1$, *i.e.*, if there is no transmission, then:

$$\Phi_j = \Phi' = \begin{bmatrix} A & B \\ 0 & I \end{bmatrix}. \quad (3.5)$$

Our goal is to find a suitable switching policy η , in order to obtain a good trade-off between the control performance and the energy consumption. To this aim, we define an optimization problem, where the cost function takes into account these two criteria:

$$J(x_0, \eta) = \sum_{k=0}^{\infty} \lambda^k \ell_{v_k}(x_k),$$

where $v_k = \eta(x_k)$ and $x_{k+1} = f_{v_k}(x_k)$. Here, $\lambda > 0$ is a forgetting factor while $\ell_{v_k}(x_k)$ is the cost-to-go, designed as follows:

$$\ell_{v_k}(x_k) = \underbrace{z_k^T \bar{Q} z_k}_{\text{performance}} + \underbrace{u_k^T \bar{R} u_k}_{\text{control energy}} + \underbrace{\theta_{m_k v_k}}_{\text{transmission energy}},$$

for some symmetric, positive definite matrices \bar{Q} and \bar{R} . Recalling that the control input u_k satisfies Eq. (3.2), the cost-to-go can be re-written in the following form, which clarifies that it depends on x_k and v_k only:

1. if $v_k = 1$, i.e., if $u_k = -Kz_k$, then:

$$\ell_1((\zeta_k, m_k)) = \zeta_k^T \underbrace{\begin{bmatrix} \bar{Q} + K^T \bar{R} K & 0 \\ 0 & 0 \end{bmatrix}}_{Q_1=Q} \zeta_k + \theta_{m_k 1} \quad (3.6)$$

2. if $v_k = j \neq 1$, i.e., if $u_k = u_{k-1} = \bar{u}$, then:

$$\ell_j((\zeta_k, m_k)) = \zeta_k^T \underbrace{\begin{bmatrix} \bar{Q} & 0 \\ 0 & \bar{R} \end{bmatrix}}_{Q_j=Q'} \zeta_k + \theta_{m_k j} \quad (3.7)$$

The optimization problem is summarized as follows.

Problem.

Find a stationary policy $\eta^*(x_k)$ such that

$$J(x_0, \eta^*) = \min_{\eta} J(x_0, \eta).$$

The cost is defined as

$$J(x_0, \eta) = \sum_{k=0}^{\infty} \lambda^k \ell_{v_k}(x_k),$$

where $v_k = \eta(x_k)$, $x_{k+1} = f_{v_k}(x_k)$ as defined in Eq.s (3.3), (3.4), (3.5), $\lambda > 0$ is a forgetting factor and $\ell_{v_k}(x_k)$ is the cost-to-go described by Eq.s (3.6) and (3.7).

Remarks

- Choosing the switching policy at time k is equivalent to choosing the radio-mode.

- We are interested in solving this problem under the following assumptions: the plant described by Eq. (3.1) is not stable, with all the eigenvalues of A greater or equal to 1; the initial state is not zero, $z_0 \neq 0$; the matrix $A - BK$ is not nilpotent; and transmissions have a non-zero cost whatever the previous mode, *i.e.*, $\theta_{m1} > 0 \forall m$.
- The horizon of the problem being infinite, finding an optimal switching policy only make sense if J converges to a finite value for, at least, one policy, η^* , which means under above assumptions that λ must be strictly less than 1. It can easily be shown that all policies result in infinite J when $\lambda = 1$. Let's assume $\lambda = 1$ and let's consider a policy that transmits only a finite number of times. There exists a time k_1 after which no more transmissions occur, then, due to the plant open-loop instability, z_k is going to diverge, and J is also going to diverge. Let's consider a policy that transmits an infinite number of times, then the part of the cost related to transmission energy diverges as being an infinite sum of $\theta_{m1} > 0$, and then J diverges.
- \bar{Q} , \bar{R} and λ are design parameters. The cost function weights \bar{Q} and \bar{R} can be tuned to give different trade-offs between estimation performance and energy consumption; it is natural to take them to be a scalar value times the identity matrix. The forgetting factor λ is used to weight the importance of immediate action versus long-term decision.
- We are only searching for a stationary policy η^* , because a time-dependent policy η_k on an infinite horizon is not implementable. Fortunately, as it is explained in Section 3.1.2, there exist a stationary policy which is optimal among all policies.

3.1.2 Solution of the optimization problem by Dynamic Programming

The Value Iteration method The optimization problem described in Section 3.1.1 can be solved using Dynamic Programming, which is based on Bellman's Principle of Optimality (Bellman 1957). Notice that the cost-to-go satisfies the positivity assumption, *i.e.*, $\ell_v(x) \geq 0$ for all $x \in \mathbb{X}$ and $v \in \mathbb{M}$. Also notice that the policy $\eta(x)$ takes values in a finite set \mathbb{M} . Thanks to these two simple facts, standard arguments in Dynamic Programming theory (see (Bertsekas 2007, Ch. 3.1)) allow to prove that there exists a stationary policy η which minimizes the cost $J(x_0, \eta)$, and which can be found by the so-called Value Iteration method, *i.e.*, by the following iterative algorithm: after initializing $V_0(x)$ to be the all-zero function, compute

$$V_{i+1}(x) = \min_{v \in \mathbb{M}} \{ \lambda V_i(f_v(x)) + \ell_v(x) \} . \quad (3.8)$$

The results in (Bertsekas 2007, Ch. 3.1) guarantee that such iterations will converge to $J^*(x) := \min_{\eta} J(x, \eta)$ as i goes to infinity, and that

$$\eta_i(x) := \arg \min_{v \in \mathbb{M}} \{ \lambda V_i(f_v(x)) + \ell_v(x) \} \quad (3.9)$$

converges to $\eta^*(x)$, an optimal stationary policy.

The derivation of the optimal switching policy consists in computing off-line $V^*(x)$ and $\eta^*(x)$. Then, the switching law $\eta^*(x)$ is used on-line to compute the switching decision v as a function of x .

Computation of the Value Function iterations In theory, the Value Iteration Method gives us an iterative algorithm, converging to the solution of our optimization problem. A caveat is that, at each iteration, we need to compute a function of x , where x takes values in an uncountable space \mathbb{X} .

A first way to implement such iterations in practice, is to partition (a portion of) \mathbb{X} in a grid, then compute the Value Function $V_{i+1}(x)$ at the grid points only, by using interpolation to find $V_i(f_v(x))$ when $f_v(x)$ is not on the grid. This approach has been taken *e.g.* in (Sundström, O., Ambühl, D. and Guzzella, L. 2010) and provides a look-up table for $\eta(x)$ at all grid points. Computationally, it is very heavy, although this is not a major issue since the long computations are done off-line, while on-line the control is chosen by accessing the look-up table.

A second approach, inspired both by the results in classic Linear Quadratic (LQ) optimal control and by the work in (Lincoln 2003), is to try to compute the functions $V_i(x)$ by exploiting some structure that they might have, if any structure exists that is preserved along iterations. For example, in LQ control, for any i the Value Function is a quadratic function of x , *i.e.*, $V_i(x) = x^T \Pi_i x$. For our problem, the structure is more involved: $V_i(x)$ is the minimum of some finite set of quadratic functions of the form $\zeta^T \Pi \zeta + \pi_m$.

Structure of the Value Function If $V_0(x) \equiv 0$, then the iterations (3.8) give value functions $V_i(x)$ such that:

$$V_i((\zeta, m)) = \min_{(\Pi, \vec{\pi}) \in \mathcal{P}_i} \left\{ \zeta^T \Pi \zeta + \pi_m \right\}, \quad (3.10)$$

where the set \mathcal{P}_i is composed of couples $(\Pi, \vec{\pi})$, where Π is a symmetric matrix and $\vec{\pi} = [\pi_1, \pi_2, \dots, \pi_N] \in \mathbb{R}^N$ is a vector of non-negative scalars.

Indeed, Eq.s (3.8)-(3.10) yield:

$$\begin{aligned} V_{i+1}((\zeta, m)) &= \min_{v \in \mathbb{M}} \left\{ \lambda V_i(f_v((\zeta, m))) + \ell_v((\zeta, m)) \right\} \\ &= \min_{v \in \mathbb{M}} \left\{ \lambda \min_{(\Pi, \vec{\pi}) \in \mathcal{P}_i} \left\{ \zeta^T \Phi_v^T \Pi \Phi_v \zeta + \pi_v \right\} \right. \\ &\quad \left. + \zeta^T Q_v \zeta + \theta_{mv} \right\} \\ &= \min_{v \in \mathbb{M}, (\Pi, \vec{\pi}) \in \mathcal{P}_i} \left\{ \zeta^T \left(\lambda \Phi_v^T \Pi \Phi_v + Q_v \right) \zeta + \lambda \pi_v + \theta_{mv} \right\} \\ &= \min_{(\Pi', \vec{\pi}') \in \mathcal{P}_{i+1}} \left\{ \zeta^T \Pi' \zeta + \pi'_m \right\}. \end{aligned}$$

The computation of $V_{i+1}(x)$ at iteration $i + 1$ consists in computing the set \mathcal{P}_{i+1} , from the set \mathcal{P}_i :

$$\mathcal{P}_{i+1} = \mathcal{P}_{i+1}^1 \cup \mathcal{P}_{i+1}^2 \quad (3.11)$$

$$\mathcal{P}_{i+1}^1 = \left\{ \left(\lambda \Phi^T \Pi \Phi + Q, \begin{bmatrix} \lambda \pi_1 + \theta_{11} \\ \lambda \pi_1 + \theta_{21} \\ \vdots \\ \lambda \pi_1 + \theta_{N1} \end{bmatrix}^T \right) : (\Pi, \vec{\pi}) \in \mathcal{P}_i \right\}$$

$$\mathcal{P}_{i+1}^2 = \left\{ \left(\lambda \Phi'^T \Pi \Phi' + Q', \begin{bmatrix} \min_{v \in \mathbb{M}^*} \{ \lambda \pi_v + \theta_{1v} \} \\ \min_{v \in \mathbb{M}^*} \{ \lambda \pi_v + \theta_{2v} \} \\ \vdots \\ \min_{v \in \mathbb{M}^*} \{ \lambda \pi_v + \theta_{Nv} \} \end{bmatrix}^T \right) : (\Pi, \vec{\pi}) \in \mathcal{P}_i \right\}$$

The initial condition is: $\mathcal{P}_0 = \left\{ (\mathbf{0}, [0, 0, \dots, 0]) \right\}$. The switching policy $\eta_{i+1}(x)$ can be derived from \mathcal{P}_i and \mathcal{P}_{i+1} . For a given $x = (\zeta, m)$, let:

$$(\Pi_{i+1,x}^*, \vec{\pi}_{i+1,x}^*) = \arg \min_{(\Pi', \vec{\pi}') \in \mathcal{P}_{i+1}} \left\{ \zeta^T \Pi' \zeta + \pi'_m \right\}.$$

By construction of \mathcal{P}_{i+1} , there exists $(\Pi_{i,x}, \vec{\pi}_{i,x}) \in \mathcal{P}_i$ and $v_x \in \mathbb{M}$ such that:

$$\Pi_{i+1,x}^* = \lambda \Phi_{v_x}^T \Pi_{i,x} \Phi_{v_x} + Q_{v_x} \text{ and}$$

$$(\vec{\pi}_{i+1,x}^*)_m = \lambda (\vec{\pi}_{i,x})_{v_x} + \theta_{mv_x}.$$

Then notice that $\eta_{i+1}(x)$, as defined in (3.9), is $\eta_{i+1}(x) = v_x$.

The convergence of the set \mathcal{P}_i to a fix set \mathcal{P}^* would imply that the optimal switching policy is reached. However, it can be seen from Eq. (3.11) that the cardinality of the set \mathcal{P}_i is doubled at each iteration. This gives rise to two problems. The first one, addressed in Section 3.1.2, is that the computation burden grows indefinitely. The second one, addressed in Section 3.1.2, is that the convergence of the algorithm cannot be observed just by observing the elements in the set \mathcal{P}_i . Note that the divergence of the cardinality of the set \mathcal{P}_i does not prevent $V_i(x)$ and $\eta_i(x)$ to converge to the optimal value function $J^*(x)$ and to the optimal policy $\eta^*(x)$, respectively.

Reducing the complexity First notice that the number of possibilities when choosing a radio-mode between N at an iteration i is N^i . By construction, our solution reduces this amount of possibilities to 2^i . But to limit further the computation burden, we propose a scheme to discard some elements in \mathcal{P}_i which are not useful. Indeed, assuming we are testing the candidate $(\Pi^{\text{cand}}, \vec{\pi}^{\text{cand}}) \in \mathcal{P}_i$, if there exists $(\Pi, \vec{\pi}) \in \mathcal{P}_i$ such that:

$$\zeta^T \Pi^{\text{cand}} \zeta + \pi_m^{\text{cand}} > x^T \Pi x + \pi_m \quad \forall (\zeta, m) \in \mathbb{X}$$

then the candidate $(\Pi^{\text{cand}}, \vec{\pi}^{\text{cand}})$ can be removed from \mathcal{P}_i .

Stopping criterion As it has been already said, having the set \mathcal{P}_i converging to a fix set would provide a stopping criterion. However, even the proposed discarding scheme in the previous section does not ensure the convergence of the sets \mathcal{P}_i . For simulation purposes, we propose the following method to stop the iterations. We divide the off-line computation into two runs. On the first run, we define a domain of interest $\Omega \subset \mathbb{R}^n \times \mathbb{R}^p$. At each iteration we are able to compute the minimum of $V_i((\zeta, m))$ for ζ taken on a grid of Ω , and we discard all the elements in the set \mathcal{P}_i which do not contribute to the minimum. We are then able to observe the number of iterations needed for the convergence. We use that number as the stopping criterion of a second run, discarding only the elements known to be useless, as defined in Section 3.1.2.

It is clear that this criterion depends on the domain Ω and on the precision of the grid. Useful elements can be discarded on the first run. However the switching policy derived with this scheme, thanks to the second run of the iteration process, is not limited to the grid points defined over Ω .

3.1.3 Simulation results

Scalar example First we give the results of our optimal mode management policy on an unstable scalar plant. The plant is as follows:

$$z_{k+1} = 2z_k + u_k$$

We use 3 radio-modes, mode 1 is ON, mode 2 is Idle and mode 3 is OFF. Transition costs are:

$$\begin{bmatrix} \theta_1 & \theta_{12} & \theta_{13} \\ \theta_{21} & \theta_2 & \theta_{23} \\ \theta_{31} & \theta_{32} & \theta_3 \end{bmatrix} = \begin{bmatrix} 10 & 4 & 7 \\ 4 & 2 & 1 \\ 7 & 1 & 0 \end{bmatrix}.$$

Weights on the cost function are: $\bar{Q} = 1$, $\bar{R} = 0.5$, the forgetting factor is set to $\lambda = 0.8$, and the gain of the state feedback is $K = 1.61$.

Note that K has been derived as the optimal LQ state-feedback in the case where the plant's state is always available.

Off-line computation As explained in Section 3.1.2, we observe a convergence of the set \mathcal{P}_i after 16 iterations, on a domain of interest $\Omega_1 = (-50, 50)$ with a precision of 1 on the grid. Since the number of iterations needed to observe a convergence depends on the domain Ω and the grid, we compute the switching policy over 20 iterations on the second run, ending with 3050 elements in \mathcal{P}_{20} , computed in about two hours.

Figures 5 and 6 show this policy, on a limited grid. The switching policy is a function of x , *i.e.* z , \bar{u} and m . We plot a figure per mode, each figure gives the optimal mode to switch to as a function of z and \bar{u} : light gray means “go to mode 1, ON”, dark gray means “go to mode 2, Idle” and black means “go to mode 3, OFF”. Fig. 5(b) shows the cost function on the same grid when current mode is ON. Cost functions associated to the other modes are omitted.

We can see on Fig. 5(a) that no direct switching is allowed from mode 1 to mode 3. The direction $\bar{u} = -Kz$ is clearly visible on the three figures. The optimal policy around this area is to switch to Idle or OFF, while outside it is to transmit the measurement (*i.e.* , to switch to ON).

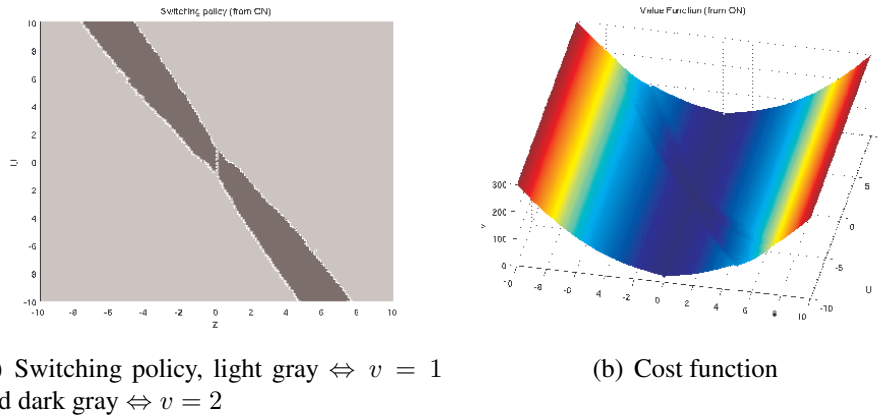

Figure 5. Optimal switching policy and cost function when current mode is 1 (ON).

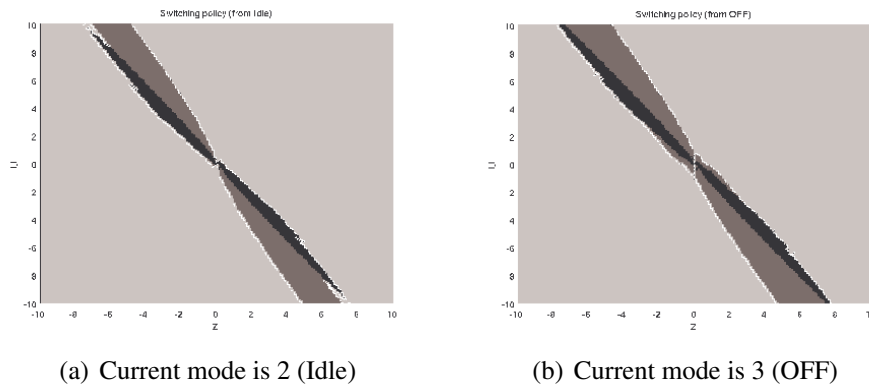

Figure 6. Optimal switching policy, light gray $\Leftrightarrow v = 1$, dark gray $\Leftrightarrow v = 2$ and black $\Leftrightarrow v = 3$

On-line simulation Once the optimal policy has been derived off-line, we can run a temporal simulation. The initial state of the system has been set to 40 and the controller should drive it to 0. Figures 7 and 8 show that the close-loop system is stable, and that the sensor chip radio is often turned to Idle or OFF modes. More comments are given about the energy savings in Section 3.1.3. We recall that the open-loop system is unstable.

Robutness in a multi-dimensional example In this section, the simulations have been proceeded on a second order plant such that:

$$z_{k+1} = \begin{bmatrix} 1 & 2 \\ 0 & 2 \end{bmatrix} z_k + \begin{bmatrix} 0 \\ 1 \end{bmatrix} u_k,$$

$$\bar{Q} = \begin{bmatrix} 1 & 0 \\ 0 & 1 \end{bmatrix},$$

$$\bar{R} = \begin{bmatrix} 0.5 & 0 \\ 0 & 0.5 \end{bmatrix},$$

$$K = \begin{bmatrix} 0.27 & 2.42 \end{bmatrix}.$$

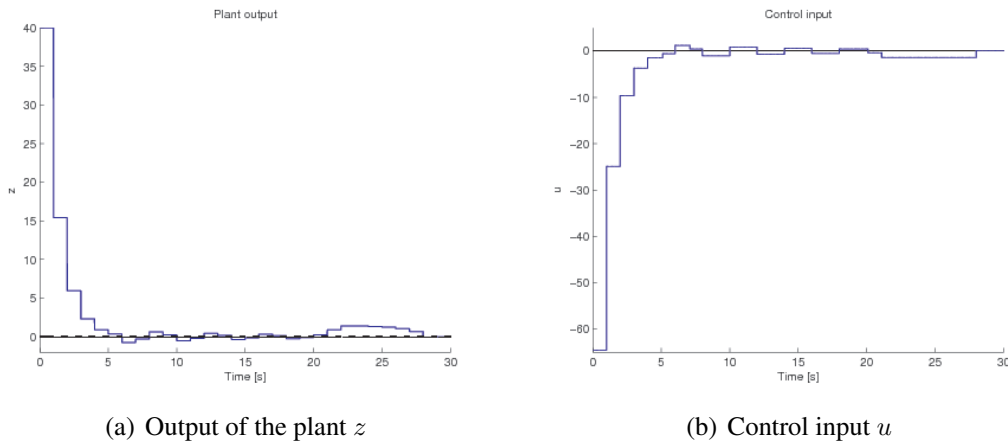

Figure 7. Temporal simulation

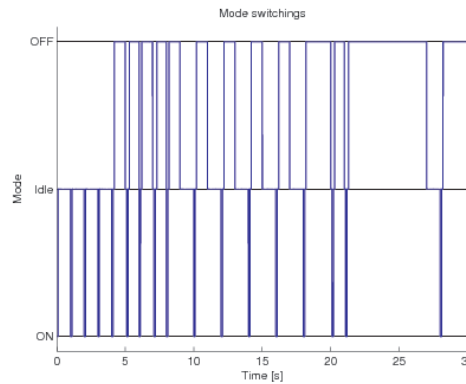

Figure 8. Temporal simulation, switching decision v .

The initial condition of the system is $z = [40 \ 20]^T$. The other parameters are the same as in Section 3.1.3.

Robustness to noise Fig. 9 shows simulation results in the case of noisy measurements. The noise is additive white gaussian noise with zero mean and unit variance. Even in the presence of noise, we obtain a bounded trajectory. But it can be seen from Fig. 9(b) that, even though the measurements are not always sent to the controller, the radio never switches to the OFF mode.

Robustness to data loss In Fig. 10, the channel is no longer perfect, and measurements are dropped independently with probability 0.30. The closed-loop system is stable and the control performance is still very good. Indeed, when a measurement is lost, the sensor tries to transmit again at the next sampling instant.

Comparison with periodic case In this last section, we have run the closed-loop simulation with a periodic switching policy on the scalar case, see Fig. 11. The periodic policy has been chosen to

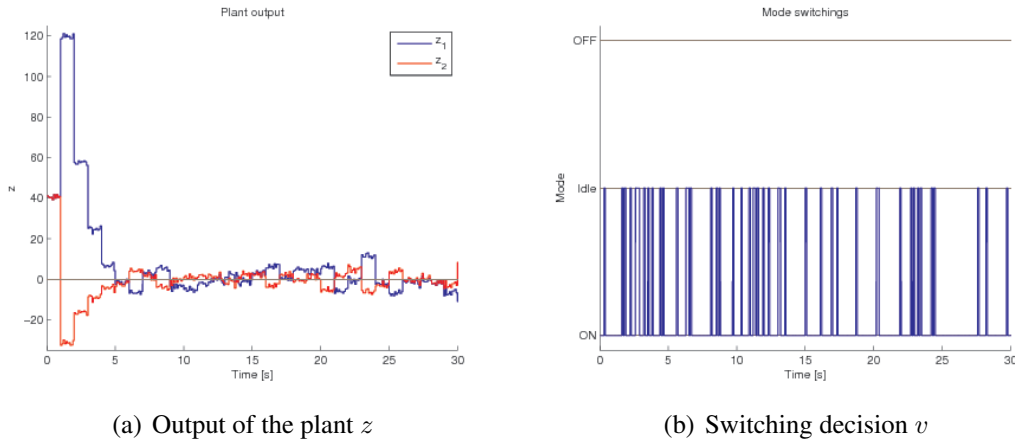

Figure 9. Temporal simulation with measurement noise

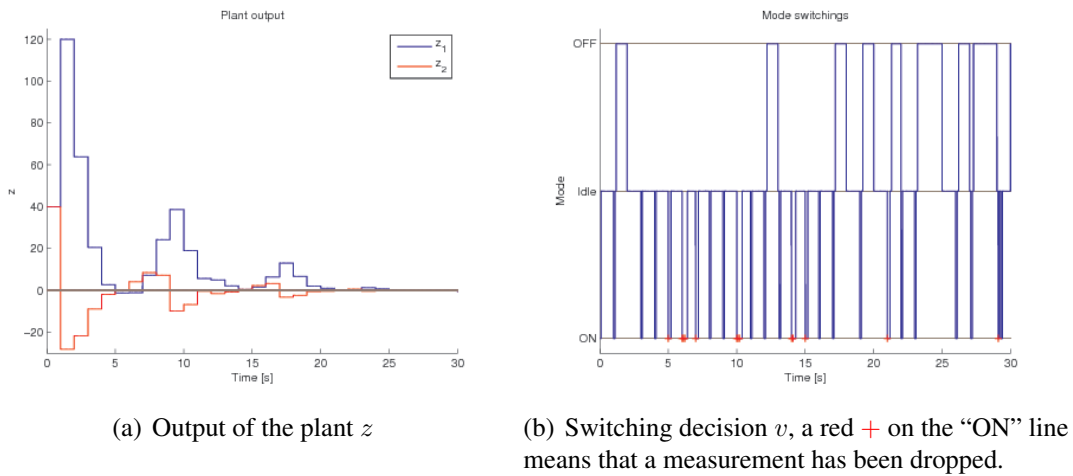

Figure 10. Temporal simulation with measurement losses.

consume the same amount of energy than the optimal policy depicted in Fig. 7. Only a limited number of transmissions is allowed, and these transmissions are uniformly distributed on the considered time window. In this case, the plant cannot be stabilised. We conclude that, with our example, the optimal solution consumes less energy than a periodic policy able to stabilize the system.

3.1.4 Conclusion and future work

In this paper we have studied the optimal management of the radio-chip mode of a wireless sensor in a networked control problem. Indeed, a rich literature from the communications community indicates that, in order to reduce the energy consumption, it is essential to wisely choose the mode of the radio-chip, between ON, OFF and some intermediate modes where only some components of the radio are switched off. The novelty of this paper is that we introduce the use of more than two radio-modes in a control problem, whereas previous related control-theoretic literature was focused on the choice between two options (ON/OFF). We have considered a simple networked control problem, with an unstable linear

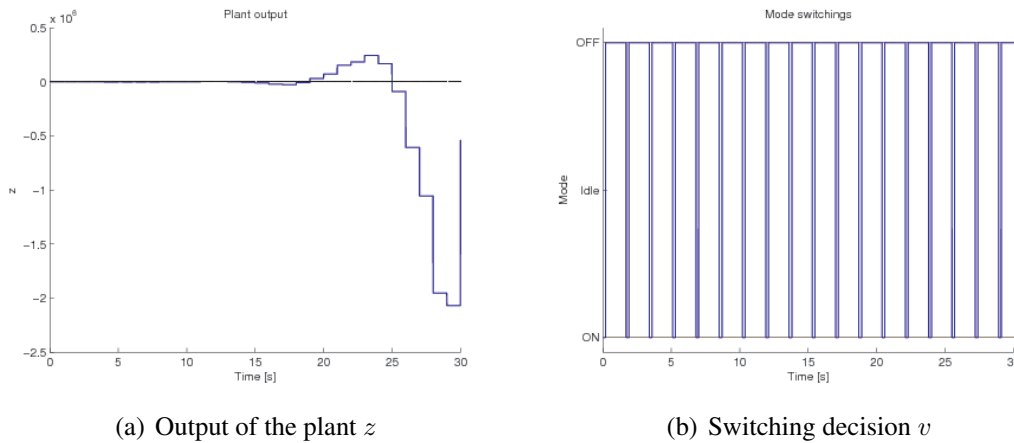

Figure 11. Temporal simulation of a periodic policy.

plant to be stabilized, and with a single sensor whose transmissions to the controller have to be performed with an optimal choice of the radio-mode. For this problem, we have defined a suitable cost function, which describes a trade-off between the control performance and the energy consumption, and whose minimum can be computed with an iterative Dynamic Programming algorithm (Value Iteration method). Although we do not have yet formal proofs of stability and robustness, our simulations show that the optimal policy which minimizes our cost function gives indeed good performance: it stabilizes the system, also in the presence of measurement noise or of packet losses in the communication channel. As a comparison, a periodic choice of the transmission mode with the same energy consumption is unable to stabilize the system in many examples where the optimal mode choice gives stability.

This work is a first step in the direction of understanding the advantages of radio-mode management in more general networked control problems. A natural extension of this work is to consider an optimization that involves not only the radio-mode, but also the feedback control law for those times where the sensor is transmitting.

A much more challenging goal will be the extension to sensors/controllers networks with more than two nodes. This general scenario is of great interest for applications, but requires a whole new theory to be developed: on the one hand, even with only two radio-modes there isn't yet a clear notion of optimal event-based sampling for a distributed multi-sensor multi-controller network; on the other hand, the coordination of multiple sensors might require them to be on an active (ON) mode also with the purpose of receiving messages in addition to sending them, and this should also be taken into account when computing the energy consumption, thus complicating the picture.

3.2 Decentralized event-based observers for LTI networked systems

Since sensor networks (SNs) are usually large scale, it is impossible in practice to employ a centralized processor to fuse data implementing the classical centralized estimation techniques. Furthermore, decentralized estimation schemes can be also unattractive in many situations given that they involve all-to-all communications, not scalable for SNs (Olfati-Saber 2005). Nonetheless, the increase of processing power of nodes enables the implementation of more intelligent distributed estimation strategies, in which each node is only allowed to communicate with a set of neighbors.

A vast literature related to the problem of distributed estimation in networked systems exists. In this context, the interested reader may find works that deal with this problem by using different approaches. For example, in (Speranzon, Fischione, Johansson and Sangiovanni-Vincentelli 2008) a novel distributed minimum variance estimator is proposed, where the filter weights are time varying and updated locally. In (Farina, Ferrari-Trecate and Scattolini 2009) and (Maestre, Giselsson and Rantzer 2010) the authors employ a distributed moving horizon scheme. In the former, each sensor has to solve a quadratic optimization problem at each time instant while implementing the moving horizon estimation problem. In the latter, the authors propose the distribution of the problem using dual decomposition.

Nevertheless, the most common approach used for distributed estimation of dynamical systems has been the distributed Kalman filter (DKF) based on consensus strategies. Roughly speaking, that technique implies correcting the local estimation performed in each of the nodes based on the information received from their different neighbors. For example, (Maestre, Muñoz de la Peña and Camacho 2011) makes use of a distributed Kalman filter together with tools from cooperative game theory to decide the communication strategy and change it in real time. In (Olfati-Saber and Shamma 2005), the estimation problem is carried out by reducing it to two separate dynamic consensus problems and solving them in a distributed way using low-pass and band-pass consensus filters. In (Olfati-Saber 2007), three novel DKF algorithms are introduced, the first based on consensus of fusion of sensor data and the two latest based on consensus on estimates. (Alriksson and Anders 2006) also follows the strategy based on consensus on estimates. In those works, each node must broadcast to its neighbor at least the complete estimated stated every sampling time.

The work described in this section tackles the problem of event-based distributed estimation, proposing a methodology to implement the communication between nodes in an asynchronous manner, reducing that way the bandwidth consumption of the overall system. The observer's structure is based on local Luenberger-like observers in combination with consensus strategies. The proposed structure allows each observer to communicate with its neighbors only when important information needs to be broadcast. A proof of the Globally Ultimately Uniformly Bounded (GUUB) of the trajectories of the estimation error has been obtained.

3.2.1 Problem description and motivation

Assume a sensor network intended to monitorize the state of a linear plant, where any sensor measures some variables (outputs), computes a local estimation of the overall state of the system under monitoring, and broadcast with a set or neighbors some information related with its own estimation. The challenge of this work is to provide a design which guarantees that all the sensors asymptotically reach a common reliable estimate of the system state in an asynchronous way.

To motivate one of the possible applications of this problem, consider the situation of monitoring the

state of a plant from different geographically distributed locations, where only some local information of the plant can be directly measured. This scenario might consist of a number of observers which have access to some, generally different, plant's outputs. The plant is not necessarily fully observable from any of this outputs (local observability is not assumed³). The different observers are able to communicate sharing information with a set of neighbors in order to estimate the complete state of the plant. The links between the observers and the sensors which measure the systems's outputs are assumed to be reliable channels.

This scenario is schematically depicted in figure 12

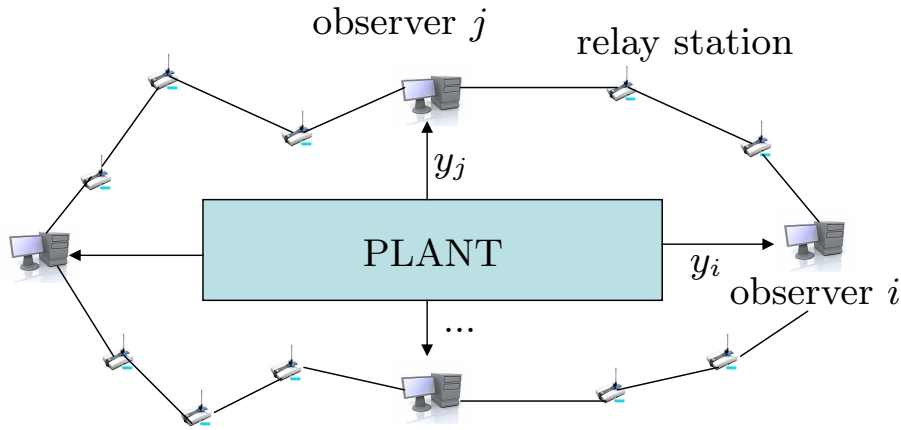

Figure 12. Distributed observation problem

The communication topology can be represented using a directed graph $\mathcal{G} = (\mathcal{V}, \mathcal{E})$, with $\mathcal{V} = 1, 2, \dots, p$ being the set of nodes (observers) of the graph (network), and $\mathcal{E} \subset \mathcal{V} \times \mathcal{V}$, being the set of links. The set of nodes connected to node i is named the neighborhood of i , and denoted as $\mathcal{N}_i \triangleq \{j \in \mathcal{V} | (i, j) \in \mathcal{E}\}$.

Assume the system to be observed (PLANT in figure 12) is an autonomous linear time-invariant plant given by the following equations:

$$x(k+1) = Ax(k), \quad (3.12)$$

$$y_i(k) = C_i x(k), \quad \forall i = 1, 2, \dots, p. \quad (3.13)$$

$$(3.14)$$

where $x(k) \in \mathbb{R}^n$ is the state of the plant, $y_i(k) \in \mathbb{R}^{m_i}$ are the system's outputs and p are the number of observers.

In order to estimate the state of the plant, we propose a structure for the observers given by the following equations:

$$\begin{aligned} \hat{x}_i(k+1) &= A\hat{x}_i(k) + M_i(\hat{y}_i(k) - y_i(k)) \\ &\quad + \sum_{j \in \mathcal{N}_i} N_{ij}(x_j(k) - x_i(k)), \end{aligned} \quad (3.15)$$

$$\hat{y}_i(k) = C_i \hat{x}_i(k), \quad \forall i = 1, 2, \dots, p, \quad (3.16)$$

³See (Olfati-Saber 2007) for the definition of this concept

The observers's dynamics are based on both, local Luenberger observers weighted with M_i matrices, and consensus with weighting matrices N_{ij} , which take into account the information that is received from neighboring nodes. The Luenberger observer corrects the estimated state of the plant based on the measured output $y_i(k)$ accessible for the observer i . However, it is not assumed that the system is completely observable from the observer i when only the system's outputs $y_i(k)$ are received.

Furthermore, the node i receives the estimated plant state from each of its neighbors j . Thus, through the consensus matrices N_{ij} , the observer i modifies the observed plant state according to information received from its neighbors.

To design the event-based estimation strategy, first it is proposed a method to design the distributed observations gains $\mathcal{M} = \{M_i, i \in \mathcal{V}\}$ and $\mathcal{N} = \{N_{ij}, i \in \mathcal{V}, j \in \mathcal{N}_i\}$ to stabilize the observations error when the different estimators communicates with its neighbors in a periodic way. Next a reduction of the bandwidth requirements through an asynchronous, event-based implementation is provided.

3.2.2 Observers design

The following result, whose proof can be found in (Millán, Tiberi, Fischione, D. and Rubio 2012), provides a design method of the distributed observations gains $\mathcal{M} = \{M_i, i \in \mathcal{V}\}$ and $\mathcal{N} = \{N_{ij}, i \in \mathcal{V}, j \in \mathcal{N}_i\}$ to stabilize the observations error when the different estimators communicates with its neighbors in a periodic way.

Proposition 3.1. *If the LMI (3.17) has a feasible solution for positive definite matrices P, Q , and matrices W_i, X_{ij} , $i = 1, 2, \dots, p$, $j \in \mathcal{N}_i$,*

$$\begin{bmatrix} -P - Q & * \\ \Phi(\mathcal{W}) + \Lambda(\mathcal{X}) & -P \end{bmatrix} < 0, \quad (3.17)$$

where

$$\begin{aligned} \Phi(\mathcal{W}) &= P\Phi(\mathcal{M}), \quad \mathcal{W} = \{W_i \triangleq P_i M_i, i \in \mathcal{V}\}, \\ \Lambda(\mathcal{X}) &= P\Lambda(\mathcal{N}), \quad \mathcal{X} = \{X_{ij} \triangleq P_{ij} N_{ij}, i \in \mathcal{V}, j \in \mathcal{N}_i\}, \end{aligned}$$

with $\Phi(\cdot)$ and $\Lambda(\cdot)$ are properly defined matrices associated with the closed-loop structure of the problem considered (See (Millán et al. 2012) for a detailed explanation).

then the estimations of all the observers asymptotically converge to the plant's state designing the observation matrices as $M_i = P_i^{-1} W_i$, $i = 1, \dots, p$, and $N_{ij} = P_{ij}^{-1} X_{ij}$, $i = 1, \dots, p$, $j \in \mathcal{N}_i$.

It is worth mentioning that comparing with consensus works (Olfati-Saber and Murray 2004, Olfati-Saber, Fax and Murray 2007), the method is not restricted to use a scalar gain on the corrections based on information between sensors, but it introduces matrix gains which are, even, different for each link.

The result in proposition 3.1 allows us to design the set of gains of the observers for the distributed estimation problem assuming synchronous communications. Next, we will exploit the stabilizing characteristics of the design method in order to develop an asynchronous, event based implementation. This makes possible to reduce the bandwidth requirements of the overall distributed system. The price to be paid is that asymptotic convergence is no longer guaranteed and, instead, ultimate boundedness of the estimation errors can be proved. That way, as it will be shown by simulations, this results in a sampling policy that allows one to reduce the bandwidth constraints of the network with a reasonable performance.

Therefore, in this section we suppose an asynchronous, event based communication policy in which each of the observers decides when it is necessary to broadcast its estimated state with his neighbors. The dynamics of the observers are given by the following equations:

$$\begin{aligned} \hat{x}_i(k+1) &= A\hat{x}_i(k) + M_i(\hat{y}_i(k) - y_i(k)) \\ &\quad + \sum_{j \in \mathcal{N}_i} N_{ij}(x_j(l_j) - x_i(k)), \end{aligned} \quad (3.18)$$

$$\hat{y}_i(k) = C_i\hat{x}_i(k), \quad \forall i = 1, 2, \dots, p, \quad (3.19)$$

where $l_j \leq k$ is the last time instant when the observer j communicated to its neighbors. Equation (3.18) takes in consideration asynchronous communication policy through the variable l_j , which can be distinct for each observer $i \in \mathcal{V}$.

As shown in (Millán et al. 2012), it is possible to express these equations such that the evolution of the estimations performed by the observers with synchronous communications it is equivalent that the evolution with asynchronous communications, with the effect of asynchronous communications being lumped to disturbance-like terms, $\omega(k)_j$, to the continuous flow of information between neighbors.

With these ideas, the following theorem, stated in (Millán et al. 2012) can be proven. The theorem provides the sampling-triggering policy to implement an event-based decentralized estimation algorithm similar to that developed in proposition 3.1 for the case of periodic communications.

Theorem 3.2. *Assume that all the observers have been designed according with proposition 3.1, and that monitors locally $\omega_j(k)$. If the observers broadcast its states whenever the constraint $\|\omega_j(k)\|_\infty < \delta$ is going to be violated, then the estimation error $e(k)$ is ultimately bounded in a ball of radius R , so that*

$\|e\|_2 \leq R = \alpha\delta\sqrt{\frac{n\lambda_{max}(P)}{\lambda_{min}(P)}}$, with α given by:

$$\alpha = \frac{\|\Gamma^T P \Xi\|_\infty + \sqrt{\|\Gamma^T P \Xi\|_\infty + \lambda_{max}(Q)\|\Gamma^T P \Gamma\|_\infty}}{\lambda_{min}(Q)} \quad (3.20)$$

3.2.3 Simulation results

Figures 13 and 14 show the performance of the methodology for an example linear plant as

$$x(k+1) = \begin{bmatrix} 0.95 & 0 & 0 \\ 0 & 0.809 & 1 \\ 0 & -0.3455 & 0.809 \end{bmatrix} x(k).$$

Two devices are estimating the plant's state measuring distinct outputs of the plant. Specifically, observer 1 has access to the first state $y_1 = [1 \ 0 \ 0]x$, while observer 2 is measuring the following output $y_2 = [0 \ 1 \ 1]x$.

Figures represent the evolutions of the plant states and the estimations of the observers for the event-based communication policy. The communications between the two neighbors nodes is reduced more than 45%

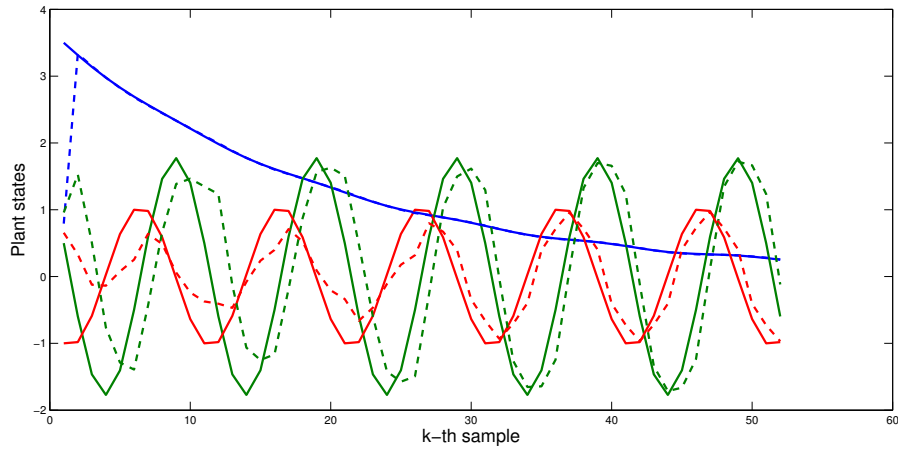

Figure 13. Evolution of states with first observer

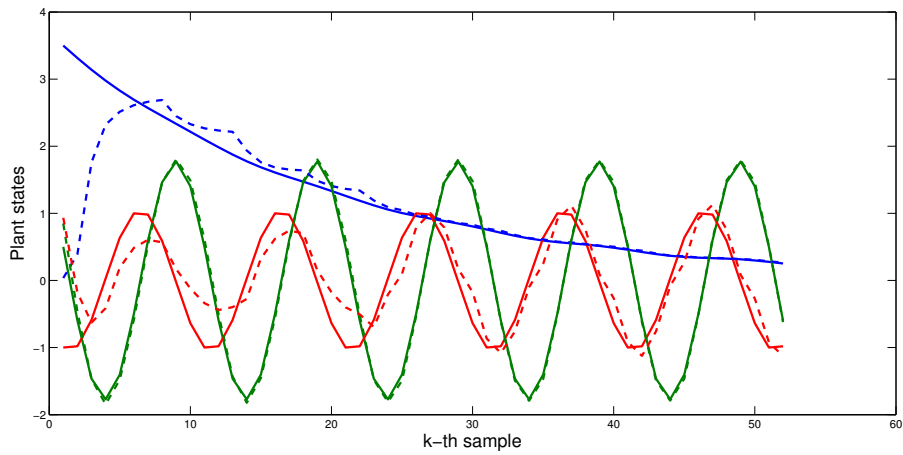

Figure 14. Evolution of states with second observer

4 Self-triggered design methodologies

4.1 Variable sample rate control of systems subject to bounded disturbances

This section presents a model-based control strategy for networked control systems subject to norm bounded disturbances. The communication channel is assumed to be shared with several processes and, therefore, data interchange is subject to collisions and packet losses. In order to minimize the access of the controller to the common network, we propose to use a variable sample rate in which the controller operates in open-loop between successive state measurements. The proposed scheme is based on solving online a sequence of quadratic optimization problems to decide the sampling time.

There can be found in Literature two different frameworks for the asynchronous control problem: event-based and self-triggered control. Under the former framework (Årzén 1999, Tabuada 2007, Hetel, Daafouz and Jung 2008, Cogill 2009, Lunze and Lehmann 2010) the controller execution is triggered according to the state or output of the plant, which requires a continuous monitoring of the state of the plant. This drawback does not appear in the latter approach (Anta and Tabuada 2008, Cogill 2009, Anta and Tabuada 2010). Self-triggered systems try to emulate the event-based ideas, but avoiding the continuous measuring of the state and, hence, the implementation problems this incurs.

It is worth mentioning the difference existing between these approaches and other control schemes in the context of robust stability of NCS subject to time-varying sampling instants (Suh 2008, Fujioka 2009, Fujioka, Nakai and Hetel 2010) in which, although sampling is also asynchronous, there is no freedom in the choice of the following sampling instant.

Aiming at reducing communication rates, different control strategies resort to the idea of using a plant model in the controller side. This idea has proven its effectiveness not only for periodic sampling (Montestruque and Antsaklis 2003, Montestruque and Antsaklis 2004, Orihuela, Rubio and Gómez-Stern 2009), but also for event-based control of linear stable systems (Lunze and Lehmann 2010).

This work tackles the problem of reducing the use of a bandwidth in a similar way as self-triggered control.

A scenario with a communication network in the sensor-to-controller path is considered. The system is a linear time invariant plant, as in (Mazo, Anta and Tabuada 2009), but assuming an imperfect knowledge of the dynamics, we have included bounded additive disturbances to the model. Starting from the knowledge of a stabilizing feedback controller K , designed for a local control, with an associated Lyapunov function $V(t)$, a model-based controller is implemented.

Model-based controller has been applied in previous works for event-based systems, but only for stable plants, see (Lunze and Lehmann 2010). Furthermore, the idea of restating the model whenever a new state measure arrives from the plant is employed, as proposed for periodic sampling in (Montestruque and Antsaklis 2003).

Thus, the controller evolves open-loop between two consecutive samples. The following sampling time is decided by the controller in such a way that the number of accesses to the shared network is minimized. Differently from event-triggered control systems, this strategy does not require the computational complexity introduced by the event generator in the plant side. In order to decide the following sampling time the controller must solve on-line a sequence of quadratic optimization problems (QPs).

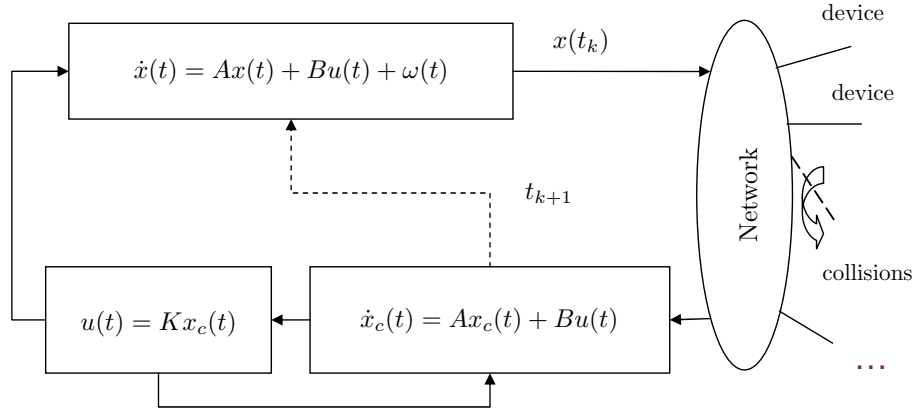

Figure 15. Networked control system

4.1.1 Problem formulation: continuous-time case

Consider first a continuous time linear system subject to bounded disturbances:

$$\dot{x}(t) = Ax(t) + Bu(t) + \omega(t), \quad (4.1)$$

where $x(t) \in \mathbb{R}^n$ is the state vector, $u(t) \in \mathbb{R}^m$ is the control input vector and $\omega(t) \in \mathcal{W} \subset \mathbb{R}^n$ is the process disturbance where:

$$\mathcal{W} = \{\omega \in \mathbb{R}^n : \|\omega\|_\infty \leq \gamma, \gamma > 0\}. \quad (4.2)$$

It is assumed that a feedback local controller K , associated with a Lyapunov function $V(t) = x^T(t)Px(t)$, has been designed for system (4.1) so the control law $u(t) = Kx(t)$ ensures stability of the closed-loop system when is implemented in continuous time with $\omega \equiv 0$.

Proposed Control Structure We assume that system (4.1) is controlled through a network. The inclusion of such a network in the control loop induces collisions and packet dropouts. This problem becomes more important as the number of devices connected to the network and the sampling frequency of such devices grow. In order to control the system while minimizing the network traffic load, we resort to a model-based controller that essentially replicates the plant dynamics.

$$\dot{x}_c(t) = Ax_c(t) + Bu(t), \quad (4.3)$$

$$u(t) = Kx_c(t), \quad (4.4)$$

$$x_c(t_k) = x(t_k), \quad k = 0, 1, 2, \dots \quad (4.5)$$

where t_k are the time instants in which the sensors measure the state of the plant and send it to the controller. Figure 15 shows a scheme of the proposed control structure. Controller is designed in such a way that the state of the controller model is updated whenever a new sample arrives, evolving afterwards open-loop until the next measure reaches the controller. The main difference between this approach and the one in (Montestruque and Antsaklis 2003) is that, in the proposed approach, the following sampling time is decided on-line by the controller, taking the process disturbances explicitly into account. As

Figure 15 suggests, the controller is next to the actuator, and hence, the same control signal is applied to the system and to the model.

We assume that a communication protocol between the sensors and the controller is operating in such a way that it is possible for the controller to schedule the sampling instants. This could be performed, for instance, if the controller sends a packet to the sensors which contains the information of the next sampling instant. The arrival of this packet triggers a sensor event-based protocol that samples and sends the state of the plant. Moreover, this packet would serve for acknowledgement (ACK) purposes.

The sensor is required to sample the plant in an event-driven manner, but this requirement is technically difficult to meet for real-time systems. Therefore, it will be assumed that there exists a base sampling time, Δ , such that the sensor has access to the measures at instants $t_k = j_k \Delta$, being j_k ($k = 1, 2, 3, \dots$) integers such that $\{j_1, j_2, j_3, \dots\} \subseteq \{1, 2, 3, \dots\}$, and $j_k < j_{k+1}$.

It is interesting to notice that j_k needs not to be a comprehensive set, so packet losses are considered. Obviously, the choice of the following sampling time t_{k+1} will be affected by these dropouts, as we will see in the following section. The constraint $j_k < j_{k+1}$ implies that out-of-order packets are rejected by the controller. This can be performed, for instance, numbering the sampled packet in the sensor's side.

The following assumption is fairly common in this context, see for example (Walsh, Beldiman and Bushnell 2001) or (Walsh, Ye and Bushnell 2002).

Assumption 4.1. *The maximum number of consecutive data dropouts through the network is bounded by $n_p \in \mathbb{N}$.*

The main goal of the controller is to minimize the network load. To that end the controller computes the next sampling instant given the feedback gain K , the Lyapunov function $V(t) = x^T(t)Px(t)$, and the controller state $x_c(t)$. In the following section we present the proposed Lyapunov-based sampling procedure.

Lyapunov-based Sampling Procedure This section describes a procedure to minimize the access to the shared network, presenting a method to decide the next sampling time based on the Lyapunov function. In this section we assume flawless communications, the procedure will be extended to unreliable channel in the following section.

In view of equation (4.1) and equations (4.3)-(4.5), the model error $\delta(t)$ can be defined as:

$$\delta(t) \triangleq x(t) - x_c(t). \quad (4.6)$$

The dynamic of the error equation is described by:

$$\begin{aligned} \dot{\delta}(t) &= \dot{x}(t) - \dot{x}_c(t) \\ &= Ax(t) + Bu(t) + \omega(t) - Ax_c(t) - Bu(t), \\ &= A\delta(t) + \omega(t), \quad \forall t \in [t_k, t_{k+1}), \end{aligned} \quad (4.7)$$

where $\delta(t_k) = 0$. A possible evolution of the state of the system and the error is depicted in Figure 16.

The dynamics of the controller state and the model error between two consecutive sampling times can

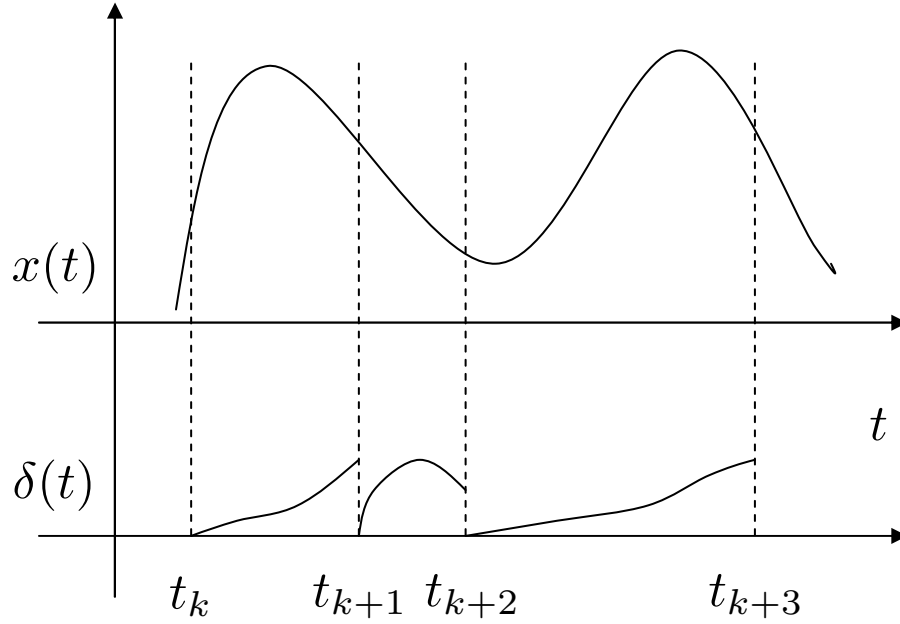

Figure 16. Possible evolution of the state and the model error

be written as follows:

$$x_c(t) = e^{(A+BK)(t-t_k)}x_c(t_k), \quad \forall t \in [t_k, t_{k+1}) \quad (4.8)$$

$$\begin{aligned} \delta(t) &= e^{A(t-t_k)}\delta(t_k) + \int_{t_k}^t e^{A(t-\tau)}\omega(\tau)d\tau = \\ &= \int_{t_k}^t e^{A(t-\tau)}\omega(\tau)d\tau, \quad \forall t \in [t_k, t_{k+1}) \end{aligned} \quad (4.9)$$

The following proposition is needed for further developments.

Proposition 4.2. *If the dynamics of the error variable is given by (4.9), the error can be bounded as follows:*

$$\|\delta(t)\|_\infty \leq \gamma\phi(t, t_k) \quad (4.10)$$

where $\phi(t, t_k) = \frac{1}{\|A\|_\infty}(e^{\|A\|_\infty(t-t_k)} - 1)$ and $\|A\|_\infty$ is the infinite norm of A .

See (Millán, Orihuela, Muñoz de la Peña, Vivas and Rubio 2011) for a proof of this result.

In what follows, the Lyapunov-based sampling procedure is developed. The controller's goal is to maximize the next sampling instant t_{k+1} . Taking time derivative of the Lyapunov function for $t \in [t_k, t_{k+1})$ yields

$$\frac{d}{dt}V(t) = x^T(t)P\dot{x}(t) + \dot{x}^T(t)Px(t) = 2x^T(t)P\dot{x}(t). \quad (4.11)$$

Now, substituting $x(t)$ from equation (4.6),

$$\begin{aligned}
 \dot{V}(x(t)) &= 2(\delta^T(t) + x_c^T(t))P(\dot{\delta}(t) + \dot{x}_c(t)) \\
 &= 2(\delta^T(t) + x_c^T(t))P(A\delta(t) + \omega(t) + Ax_c(t) + Bu(t)) \\
 &= \delta^T(t)(PA + A^T P)\delta(t) + 2\delta^T(t)P\omega(t) + 2x_c^T(t)P\omega(t) \\
 &\quad + 2\delta^T(t)(PA + A^T P + PBK)x_c(t) + \\
 &\quad + x_c^T(t) \left(P(A + BK) + (A + BK)^T P \right) x_c(t), \quad \forall t \in [t_k, t_{k+1}).
 \end{aligned} \tag{4.12}$$

The controller will try to solve the following optimization problem:

$$\max t_{k+1} \tag{4.13}$$

$$\text{subject to} \tag{4.14}$$

$$\begin{aligned}
 \frac{d}{dt}V(x(t)) &\leq 0, \quad \forall t \in [t_k, t_{k+1}) \\
 \|\omega(t)\|_\infty &\leq \gamma \\
 \|\delta(t)\|_\infty &\leq \gamma\phi(t, t_k)
 \end{aligned}$$

This optimization problem is not easy to solve. The parameter to be optimized, i.e. t_{k+1} , is involved in a nonlinear equation and there are an infinite number of constraint, because they must be satisfied for all t . We will prove in the next section that this optimization problem can be cast as a sequence of Quadratic Programming (QP) problems.

Solution for the optimization problem Problem (4.13) can be cast as a sequence of QP problems, which can be solved efficiently (Nocedal and Wright 2006), as the following decision algorithm suggests:

Algorithm

1. Set $n = 0$.
2. Solve the problem

$$\min_{\delta, \omega} -\dot{V}(\delta(t), \omega(t)), \tag{4.15}$$

subject to

$$\begin{aligned}
 \|\omega(t)\|_\infty &\leq \gamma \\
 \|\delta(t)\|_\infty &\leq \gamma\phi(t, t_k)
 \end{aligned}$$

with $t = t_{k+1} = t_k + T_{min} + n\Delta$.

3. If $\dot{V}(t_{k+1}) \leq 0$, increase $n = n + 1$ and go to Step 2. Otherwise, choose $t_{k+1} = t_k + (n - 1)\Delta$.

where T_{min} is lower bound for the following sampling time.

Remark. The value of Δ must be chosen such that the dynamics of $x_c(t_k)$, and hence $\dot{V}(t)$, are smooth between two consecutive sampling times and the continuous dynamics of $\dot{V}(t)$ is adequately captured by the discrete representation with period Δ .

The length of the next sampling period is decided at the controller size as $T_{min} + n_{opt}\Delta$, with n_{opt} being the final value of n for the previous algorithm. It remains to prove that problem (4.15) can be stated as a QP.

Proposition 4.3. *Problem (4.15) for $t = t_{k+1}$ can be formulated as a QP problem as*

$$\min_x f(x) = \min_x \frac{1}{2}x^T Qx + c^T x, \quad (4.16)$$

subject to

$$Fx \leq b \text{ (inequality constraint)} \quad (4.17)$$

$$Ex = d \text{ (equality constraint)} \quad (4.18)$$

where

$$\begin{aligned} x &= \begin{bmatrix} \delta(t_{k+1}) \\ \omega(t_{k+1}) \end{bmatrix}, \\ Q &= -2 \begin{bmatrix} PA + A^T P & P \\ P & 0 \end{bmatrix}, \\ c^T &= -2x_c^T(t_{k+1}) \begin{bmatrix} PA + A^T P + K^T B^T P & P \end{bmatrix}, \end{aligned} \quad (4.19)$$

and for the inequality constraint

$$F = \begin{bmatrix} I_n & 0 \\ -I_n & 0 \\ 0 & I_n \\ 0 & -I_n \end{bmatrix}, \quad b = \begin{bmatrix} \gamma\phi(t_{k+1}, t_k)I_{n \times 1} \\ \gamma\phi(t_{k+1}, t_k)I_{n \times 1} \\ \gamma I_{n \times 1} \\ \gamma I_{n \times 1} \end{bmatrix}. \quad (4.20)$$

where $I_{n \times 1}$ is a column vector whose components are ones.

See (Millán et al. 2011) for a proof of this result.

Extension to unreliable channels Up to this moment, perfect channels have been assumed, as no delays, packet dropouts or quantization effect have been introduced. However, in NCS framework is quite common the use of non-reliable protocols, such us User Datagram Protocol (UDP), because of the requirements of real-time connections.

For these reasons we will consider in our formulation that the information sent by the sensors is affected by possible packet losses. A possible data exchange between sensor and controller is depicted in Figure 17. To extend previous results for an scenario in which packet dropouts are present, the controller will follow Algorithm 1 to obtain next sampling time without losses t_{k+1}^{wl} . However, to ensure the stability of the system, it will send to the sensor the following sampling instant:

$$t_{k+1} = t_{k+1}^{wl} - n_p \Delta, \quad (4.21)$$

in such a way that if n_p packets are lost consecutively, the real sampling time is t_{k+1}^{wl} . It is assumed that the sensor knows if its packet has been received due to ACK packets.

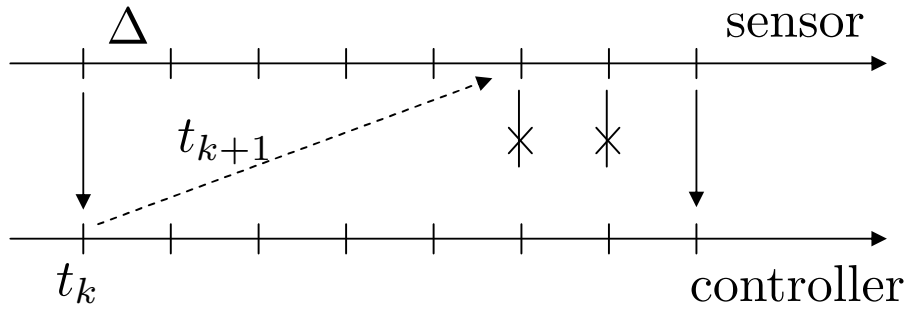

Figure 17. Data exchange between sensor and controller

4.1.2 Problem formulation: discrete-time case

Previous results can be easily adapted to discrete-time case assuming a plant structure in the form

$$x(k+1) = Ax(k) + Bu(k) + \omega(k), \quad (4.22)$$

$$x(0) = x_0, \quad (4.23)$$

where $x(k) \in \mathbb{R}^n$, and $u(k) \in \mathbb{R}^m$ are the state vector and control input vectors respectively. The process disturbance is $\omega(k) \in \mathbb{R}^n$, and satisfies $\omega(k) \subseteq \mathcal{W}$, where:

$$\mathcal{W} = \{\omega \in \mathbb{R}^n : \|\omega\|_\infty \leq \gamma, \gamma > 0\}. \quad (4.24)$$

Similarly to the continuous-time case it can be assumed that a state-feedback local controller gain K , associated with a discrete Lyapunov function $V(k) = x^T(k)Px(k)$, has been designed for system (4.22) so that the control law $u(k) = Kx(k)$ ensures practical stability of the closed-loop system.

The discrete-time model-based controller takes now the form:

$$x_c(k+1) = Ax_c(k) + Bu(k), \quad (4.25)$$

$$x_c(t_k) = x(t_k), \quad k = 0, 1, 2, \dots \quad (4.26)$$

$$u(k) = Kx_c(k), \quad (4.27)$$

where t_k are the time instants when the sensors measure the state of the plant and send it to the controller. The sensor is required to sample the plant in an event-driven manner, at time instants t_k .

Under these considerations closed-loop equations of system (4.22)-(4.23) and controller (4.25)-(4.27) while the latter is evolving in open-loop are given by:

$$x(k+1) = Ax(k) + BKx_c(k) + \omega(k), \quad (4.28)$$

$$x(t_0) = x_0, \quad (4.29)$$

$$x_c(k+1) = (A + BK)x_c(k), \quad \forall t \in [t_k, t_{k+1}), \quad (4.30)$$

$$x_c(t_k) = x(t_k), \quad k = 1, 2, \dots, \quad (4.31)$$

where time t_k is the instant in which the controller receives the measurement from the sensor. It is worth mentioning that sampling instant t_k was calculated by the controller in the previous interval.

Recall that the main goal of the controller is to minimize the network load preserving the system stability. To that end the controller calculates the next sampling instant given the feedback gain K , the Lyapunov function $V(k) = x^T(k)Px(k)$, and the controller state $x_c(k)$.

Defining now the model error $\delta(k)$ as $\delta(k) \triangleq x(k) - x_c(k)$, the Lyapunov-based sampling procedure above described for continuous-time can be restated, considering that the dynamics of the controller state and model error between two consecutive sampling times can be written as follows:

$$x_c(t_k + j) = (A + BK)^j x(t_k), \forall j : \{j \in \mathbb{N}, t_k + j < t_{k+1}\} \quad (4.32)$$

$$\delta(t_k + j) = \sum_{i=1}^j A^{i-1} \omega(t_k + j - i), \forall j : \{j \in \mathbb{N}, t_k + j < t_{k+1}\} \quad (4.33)$$

It can be checked that the model error can be bounded as

$$\|\delta(t_k + j)\|_\infty < \gamma \sum_{i=1}^j \|A^{i-1}\|_\infty. \quad (4.34)$$

Taking now forward differences of the Lyapunov function and following similar arguments to that presented for the continuous-time case, the problem of maximizing the next sampling instant can be posed as the optimization problem:

$$\max_{s.t.} t_{k+1} \quad (4.35)$$

$$\Delta V(t_k, t_k + j) \leq 0, \forall j : \{j \in \mathbb{N}, t_k + j < t_{k+1}\}$$

$$\|\delta(t_k + j)\|_\infty < \gamma \sum_{i=1}^j \|A^{i-1}\|_\infty, \forall j : \{j \in \mathbb{N}, t_k + j < t_{k+1}\}. \quad (4.36)$$

And the discrete-time equivalent of the algorithm to solve such problem is **Algorithm 2**.

1. Set $j = 1$.
2. Solve the problem

$$\min_{\delta} -\Delta V(t_k, t_k + j)(\delta), \quad (4.37)$$

subject to

$$\|\delta(t_k + j)\|_\infty < \gamma \sum_{i=1}^j \|A^{i-1}\|_\infty.$$

3. If $\Delta V(t_k, t_k + j) \leq 0$, increase $j = j + 1$ and go to Step 2. Otherwise, choose $t_{k+1} = t_k + j$.

This algorithm admits a formulation as a QP problem as in (4.16), taking

$$\begin{aligned} \xi &= \delta(t_{k+1}), \\ H &= -P, \\ f^T &= -2x_c^T(t_k + j), \end{aligned} \quad (4.38)$$

and for the inequality constraint

$$D = \begin{bmatrix} I \\ -I \end{bmatrix}, \quad b = \begin{bmatrix} \gamma \sum_{i=1}^j \|A^{i-1}\|_{\infty} \cdot \\ -\gamma \sum_{i=1}^j \|A^{i-1}\|_{\infty} \cdot \end{bmatrix}. \quad (4.39)$$

It is worth mentioning that in Algorithm 2 the minimum sampling time is one. It is not possible to ensure that $V(k)$ decreases for all k because of the presence of bounded disturbances $\omega(k)$, which can make $\Delta V(k, k+1)$ strictly positive in a neighborhood of the origin. However, it is worth reminding that, by assumption, the system practical stability is guaranteed for the controller K with sampling time equal to one.

4.1.3 Performance

In this section, we are going to apply the previous result to an unstable plant in order to show how the controller manages to reduce the traffic load maintaining the practical stability of the system.

Consider the following example LTI system:

$$\dot{x}(t) = \begin{bmatrix} 1 & 0.99 \\ 0 & 1 \end{bmatrix} x(t) + \begin{bmatrix} 0 \\ 1 \end{bmatrix} u(t) + \omega(t), \quad (4.40)$$

where the disturbances $\omega(t)$ are supposed to verify $\|\omega(t)\|_{\infty} \leq 0.01$. The initial condition for the system and the controller is $x_0^T = [10 \quad -5]$.

Choosing a sampling rate $T_{min} = 1$ s (which ensures the asymptotic stability of the system without disturbances), the following stabilizing controller has been designed:

$$K = \begin{bmatrix} -4.5263 & -4.4110 \end{bmatrix}$$

The Lyapunov function can be described by

$$V(t) = x^T(t) \begin{bmatrix} 0.2161 & 0.1156 \\ 0.1156 & 0.1083 \end{bmatrix} x(t).$$

Assuming that no disturbances are present, the evolutions of the system and the error between the state of the system and of the controller are shown in Figure 18. Also the asynchronous sampling times are drawn. Only the first three sampling times are bigger than 1 seconds due to the error is quite small.

Assume now that the disturbances are not zero. Figure 19 shows this situation. Again, the sampling rates are bigger than the basic rate only when the system is far from the equilibrium.

Finally, we test the method with the following description of the disturbances. At the beginning, uniform disturbances are applied. Next, the system evolves with greater disturbances to get it out of the equilibrium. At the end, uniform disturbances are assumed again. The asynchronous sampling periods for this case are shown in Figure 20.

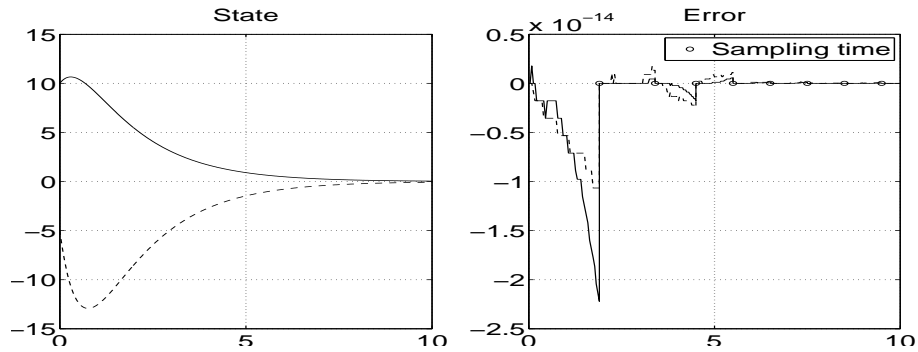

Figure 18. Evolution without disturbances. Solid and dashed lines for different components

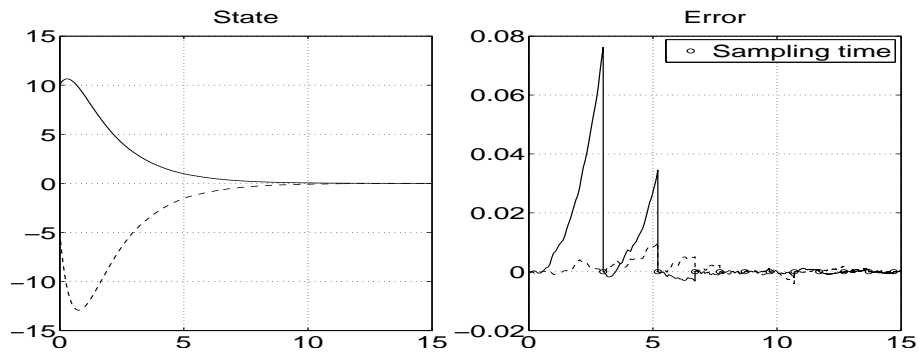

Figure 19. Evolution with uniform disturbances

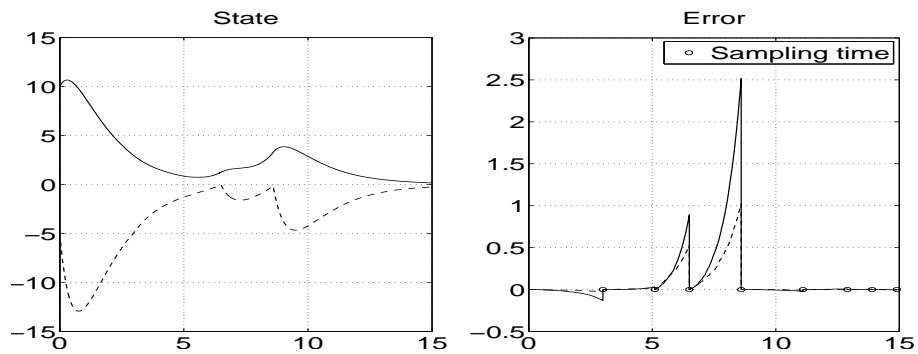

Figure 20. Asynchronous sampling periods

4.2 Adaptive Self-triggered Control over IEEE 802.15.4 Networks

Networked Control Systems (NCS) based on energy efficient wireless sensor networks (WSNs) are being widely deployed for many industrial and civilian applications. Building and industrial automation, smart grids, and health care are typical examples (Ploplys, Kawka and Alleyne 2004, Willig 2008). The IEEE 802.15.4 communication protocol is the most popular standard for low power and low data rate WSNs (IEEE 2006). In industrial automation, it has been adopted with minor variations also by other protocols such as WirelessHART and ISA100 (Willig 2008). Moreover, the Internet engineering task force is currently standardizing the RPL routing protocol for WSNs, which is largely based on it (*Routing Over Low power and Lossy networks (roll)* n.d.). We believe that IEEE 802.15.4 will play a dominant role in WSNs applications as the one played by TCP and UDP protocols for the Internet. Despite such a popularity, there are little or no studies for designing NCSs over IEEE 802.15.4.

In an NCS, sensors take measurements of the plants and send them to the controllers via a communication network. Typical problems are the loss of state information due to packet dropouts and delays in the packet transmission due to retransmissions, channel contentions among transmitters, and congestions (Hespanha et al. 2007). To cope with these problems, several studies have been proposed in the literature, which we believe can be roughly grouped into three design approaches: a top-down, a bottom up, and a system-level approach, as we discuss next.

By the first approach, packet losses and delays introduced by the communication network are considered as non-idealities, and the controllers are designed without having any influence on them, see e.g., (Hespanha et al. 2007) and the references therein. The essential need of energy efficiency usually required by WSNs (Willig 2008) is often ignored and there is not a systematic attempt to adapt the protocols so the controllers may work in more favorable conditions.

On the other side, protocols for WSNs are often designed to maximize the reliability and minimize the delay to ensure suitable control performance. This is a bottom-up approach, where controller specifications are not explicitly considered even though the protocols are intended to be used for NCSs. This approach is energy inefficient because high reliability and low latency may demand significant energy consumption (Willig 2008). A trade-off between latency, packet losses, and stability requirements can be exploited for the benefit of the energy consumption, as proposed by the system-level design (A. Bonivento, C. Fischione, L. Necchi, F. Pianegiani, A. Sangiovanni-Vincentelli 2007, Speranzon, Fischione and Johansson 2006, Speranzon et al. 2008). By following such an approach, entirely new protocol stacks have been developed for control over WSNs, such as Breath and TREnD, see (Park 2009, Di Marco, Park, Fischione and Johansson 2010).

However, concerning the already standardized protocol as IEEE 802.15.4, there is not yet a systematic study for NCSs. In existing contributions, fundamental results are developed by abstracting the network only in terms of packet losses and time delays, whereas the essential aspect of energy consumption is not considered, and the typical dynamics of network protocols are not taken into account. The idea of adapting communication parameters to the requirements of the controllers is not new, but most of the existing contributions are concerned with adaptation of physical layer parameters, including the modulation formats, the radio powers, transmit rates, and Shannon capacity, e.g., (Xiao, Johansson, Hindi, Boyd and Goldsmith 2003, Azimi-Sadjadi 2003, Bao 2009), which cannot be adapted by the IEEE 802.15.4 protocol. Some adaptation is possible at the medium access control layer, which however has some strict rules that make it difficult to transmit packets at desired times.

In this chapter, we consider the problem of system-level design of NCSs over IEEE 802.15.4 networks.

The original contribution is as follows:

1. A self-triggered sampling strategy for ensuring the stability for NCSs where the feedback channel is over an IEEE 802.15.4 network is proposed.
2. A robust stability analysis that takes into account the IEEE 802.15.4 protocol parameters is presented.
3. A decentralized algorithm to reduce the energy consumption of the IEEE 802.15.4 network while guaranteeing the stability of the closed loop system is developed.

In this chapter we pose the problem of a system-level design of NCSs over IEEE 802.15.4 networks. We focus on self-triggered strategies, because they are energy efficient, as opposed to periodic sampling (Velasco, Marti and Fuertes 2003, Mazo and Tabuada 2008, Wang and Lemmon 2009).

The rest of the chapter is organized as follows: in Section 4.2.1, the IEEE 802.15.4 control system architecture is described and the problem tackled in this chapter is introduced. In Section 4.2.2, an adaptive sampling strategy for IEEE 802.15.4 NCSs is proposed and characterized. In Section 4.2.3, numerical simulations illustrate the analysis. Finally, in Section 4.2.4 we summarize the contribution of this chapter and future developments.

4.2.1 IEEE 802.15.4 Control System Architecture

We consider a control loop closed on a typical IEEE 802.15.4 star network, where we assume that a node is attached to a plant and transmits state information to a controller that is connected to the network coordinator node, see Fig. 21

Plant and Controller The plant is given by perturbed systems of the form

$$\dot{x} = A(\eta)x + B(\eta)u + d, \quad (4.41)$$

where $x \in \mathbb{R}^n$, $u \in \mathbb{R}^m$, η is a vector of parameters uncertainty evolving over a compact set $\mathcal{D}_\eta \subset \mathbb{R}^r$ and $d \in \mathcal{D}_d \subset \mathbb{R}^n$ is a bounded disturbance with bound $\|d(t)\| \leq \bar{d}$. We assume the following control law:

$$u(t) = Kx(t_k), \quad t \in [t_k + \tau_k, t_{k+1} + \tau_{k+1}), \quad (4.42)$$

where t_k is the time in which the measurements are picked by the sensor attached to the plant, which we call the *plant node*, and τ_k is the measurement delay, namely the time it takes for the measurement to reach the wireless node attached to the controller, which we call the *controller node*. This time delay includes the time needed to the processor of the plant node to elaborate the measurement. The control is piecewise constant. Because of the sampling, delays, parameter uncertainties the disturbances, we can obtain only *practical* stability for the closed loop system.

Definition 4.4. A system $\dot{x} = f(\eta, x, d)$ is locally ε -practically stable if for any $\varepsilon > 0$ and for any initial condition $x(t_0) \in \mathcal{D}_{x_0} \subseteq \mathbb{R}^n$ there exists a time $T \geq 0$ such that $\|x(t)\| \leq \varepsilon$ for all $t \geq t_0 + T$. If $\mathcal{D}_{x_0} = \mathbb{R}^n$ then the definition holds globally.

In the following subsection, we see that the times t_k and τ_k cannot be imposed only by the controller. They must adapt to the network protocol.

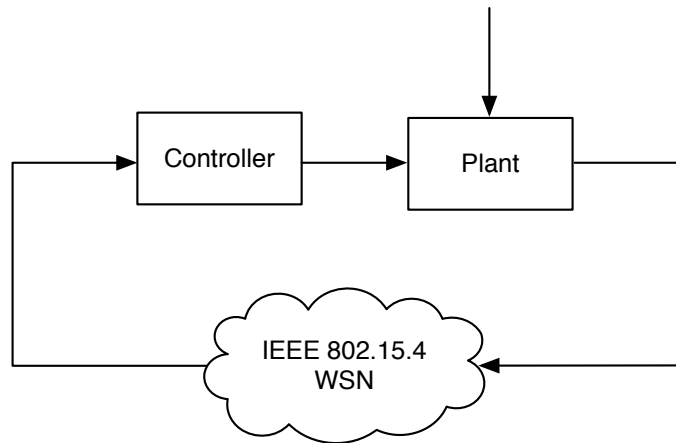

Figure 21. An IEEE 802.15.4 NCS composed by one single control loop.

Protocol Model The IEEE 802.15.4 standard specifies the physical and medium access control layers of the protocol stack of WSNs composed by low cost and low powered nodes (IEEE 2006).

In each 802.15.4 network there is a special node, the PAN coordinator, that manages the operations of the entire network. We assume that the controller is connected to this coordinator.

The standard allows the network to operate in two different modalities: the unslotted and the slotted one. In the unslotted modality nodes attempt to transmit packets according to the Carrier Sense Multiple Access/Collision Avoidance (CSMA/CA) algorithm, which checks if the channel is idle and randomly back off the transmission if it is busy. In the slotted modality, the nodes transmit packets in a time division multiple access (TDMA) fashion. The time frame of the protocol is denoted as *superframe*, which is bounded by special signalling packets sent by the PAN coordinator called *network beacons* to manage the network. Every node of the network must follow this superframe when transmitting packets. The superframe length is denoted as *Beacon Interval* (B.I.) and satisfies

$$B.I. = aBaseSuperFrameDuration \times 2^{B.O.},$$

with $0 \leq B.O. \leq 14$, where the exponent B.O. is called *Beacon Order* and *aBaseSuperFrameDuration* is a parameter of the protocol, which specifies the shortest duration of a superframe.

The superframe is split into an active portion and an inactive portion, see Fig. 22. The active portion is the time interval where there can be transmissions of packets. In the inactive period no communication is allowed and the nodes go in a sleep state to save energy. The time interval of the active period is called *Superframe Duration* (S.D.). It is divided into 16 equally sized time slots of length *aBaseSlotDuration* and satisfies

$$S.D. = aBaseSuperFrameDuration \times 2^{S.O.},$$

with $0 \leq S.O. \leq 14$ and where the exponent S.O. is called *Superframe Order*. It must be $S.O. \leq B.O.$, according to the IEEE standard. The active portion is further divided in two parts: the *Contention Access Period* (CAP) and the *Contention Free Period* (CFP). During the CAP nodes contend to access the medium with the CSMA/CA algorithm, whereas in the CFP period the PAN Coordinator reserves dedicated time slots to nodes so that they do not have to contend for transmitting packets during the CFP. During the current superframe, a node can ask to the PAN Coordinator a number of dedicated time

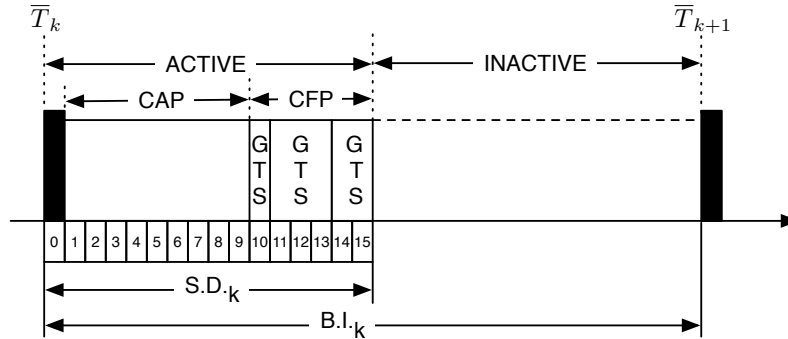

Figure 22. Slotted IEEE 802.15.4 superframe time organization. The index $k \geq 0$ denotes the k superframe. $S.D._k$ denotes the superframe duration and $B.I._k$ denotes the beacon interval. \bar{T}_k is the time in which the superframe begins. A plant node transmits packets during the guarantee time slots (GTS) of the contention free period (CFP). During the inactive period, nodes sleep to save energy. IEEE 802.15.4 allows us to adapt the protocol parameters $S.D.$ and $B.I.$ to the needs of the NCS.

slots (up to 7 time slots per superframe). Whenever possible, the PAN Coordinator allocates the required time slots for the next superframe. This mechanism is called *Guarantee Time Slots*. A time slot is called GTS. Note that during a GTS, a node can send and receive more than one packet.

At the beginning of each superframe, all the nodes of the network must be awake to receive the beacon packet from the PAN Coordinator. This beacon packet contains all the settings of the incoming superframe, such as which GTS is reserved to which node, the length of the incoming beacon interval, and the superframe duration. Note that during the inactive period, the nodes are in a sleep state. They wake up to receive the next beacon packet from the PAN Coordinator at the end of the inactive period. The IEEE 802.15.4 standard allows us to adapt the superframe to the need of the controller by tuning the *protocol parameters* $S.D.$ and $B.I.$, as we state in the following Section.

Problem Formulation In an IEEE 802.15.4 NCS, the information about the state of a plant can be sent only during the time intervals of the superframe imposed by the protocol. It follows that one must take into account these constraints imposed by the protocol in the controller design, plus the need of energy efficiency.

Since the nodes of an IEEE 802.15.4 WSN work with batteries with limited charge, a control strategy should minimize the number of transmissions over the network, which consume most of the energy available at the nodes (Willig 2008). The protocol parameters (the beacon interval and superframe duration) and the controller should cooperate to put the nodes in a sleep state as long as possible. Then, to reduce both the sampling times and the number of transmissions (thus the network energy consumption), and to obtain ε -practical stability of the closed loop system, we design a *self-triggered sampler* that has the form

$$t_{k+1} = t_k + \gamma(\zeta), \tag{4.43}$$

where ζ is a vector taking into account the state of the system, time delays etc, and $\gamma(\cdot)$ is a function that we design to obtain

1. ε -practically stability over IEEE 802.15.4,
2. low network energy consumption.

We can state the problem as in the following:

Problem 4.5. *Consider the system (4.41) in which the feedback channel is over an IEEE 802.15.4 network. Determine under which conditions the closed loop system is ε -practically stable by the feedback control (4.42), and choose the self-triggered sampling instants t_k as specified in Eq. (4.43) that reduces the energy consumption of the network.*

We assume that nodes transmit over the contention free time slots, the GTSs, as explained above. We consider a *static* allocation of the GTS in the first slot after the slot of the beacon. We consider the case in which the plant node has one GTS allocated for each superframe and sends packets during this GTS. Since the beacon packet duration can be at most a slot size, it follows that the measurement of the state of the plant are picked at the time $T_k \triangleq \bar{T}_k + aBaseSuperFrameDuration$, where \bar{T}_k is the starting time of the k -th superframe. By this notation, we remark that T_k denotes the sampling time of the plant state allowed by the standard, whereas t_k is the sampling time wished by the controller. When the control law is compatible with the standard, then $t_k \geq T_k$. If $t_k < T_k$, we may have instability. To allow the plant node to send a packet, the admissible minimum beacon interval is $B.I._{min} = aBaseSuperFrameDuration \times 2$. We assume an initial delay $\tau_0 = 0$ and $\tau_k \leq aBaseSlotDuration, \forall k > 0$, namely the state information is picked, transmitted, and received inside the GTS time slot. The delay due to the sensing, transmissions is included into the delay τ_k . These assumptions are coherent with the IEEE 802.15.4 standard.

4.2.2 Self-triggered IEEE 802.15.4 NCSs

A preliminary result to obtain a robust self-triggered sampler so that we have ε -practical stability of the closed loop system is developed in Section 4.2.2. Then, in Section 4.2.2, we extend this result to an IEEE 802.15.4 network. Finally, in Section 4.2.2, we propose a decentralized algorithm that adapts dynamically the IEEE 802.15.4 protocol parameters to save energy.

A Self Triggered Sampler Consider the system (4.41) with control (4.42). Once the measurement is taken by the plant node at time t_k , the closed loop dynamics can be rewritten as

$$\dot{x} = (A_0 + B_0K)x + B_0K\tilde{e}_k + g(\eta, x, \tilde{e}_k) + d, \quad (4.44)$$

for $t \geq t_k + \tau_k$, where $\tilde{e}_k(t) = e_{k-1}(t_k + \tau_k) + e_k(t)$, $e_k(t) = x(t_k) - x(t)$ and A_0 and B_0 that can be viewed as nominal matrices independent of η . The assumption $\tau_0 = 0$ implies $\tilde{e}_0(t) = e_0(t)$. The function $g(\eta, x, \tilde{e}_k)$ in (4.44) is defined as

$$g(\eta, x, \tilde{e}_k) = [(A(\eta) - A_0) + (B(\eta) - B_0)K]x + (B(\eta) - B_0)K\tilde{e}_k, \quad (4.45)$$

and satisfies $\|g(\eta, x, \tilde{e}_k)\| \leq (\nu_0 + \nu_1)\|x\| + \nu_1\|\tilde{e}_k\|$, where $\nu_0 \triangleq \max_{\eta} \|A(\eta) - A_0\|$ and $\nu_1 \triangleq \max_{\eta} \|(B(\eta) - B_0)K\|$. To design the self triggered sampler we exploit the behavior of $\|e_k\|$. Note

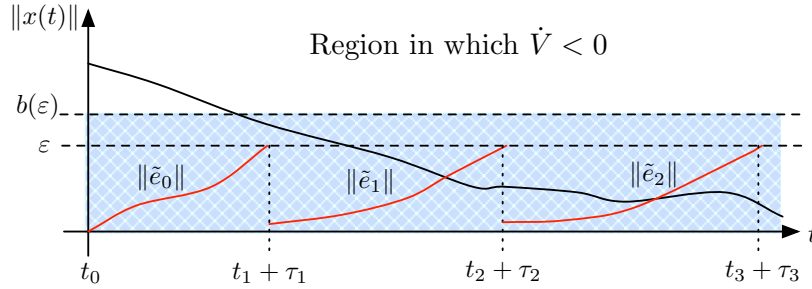

Figure 23. The proposed self-trigger sampler. The state information $x(t)$ is measured by a plant sensor at time $t_k, k = 0, 1, \dots$. The control must be updated at time $t_k + \tau_k$ as triggered by an error function $\|\tilde{e}_k\|$.

that $\dot{e}_k = -\dot{x}$ and, at the sampling time t_k , $e_k(t_k) = 0$. Although we don't know exactly $\|e_k\|$, it is possible to find an upper bound for its dynamics by observing that for $t > t_k$

$$\frac{d}{dt}\|e_k\| = (e_k^T e_k)^{-\frac{1}{2}} e_k^T \dot{e}_k \leq \frac{e_k^T \dot{e}_k}{\|e_k\|} \leq \|\dot{e}_k\|,$$

and then

$$\|\dot{e}_k\| \leq \|(A_0 + B_0 K)x(t_k)\| + (\nu_0 + \nu_1)\|x(t_k)\| + (\|A_0\| + \nu_0)\|e_k\| + \bar{d}.$$

The previous expression is in the form $\dot{y} \leq ay + b\|x(t_k)\| + \bar{d}$ where $a \triangleq \|A_0\| + \nu_0$ and $b \triangleq \|A_0 + B_0 K\| + (\nu_0 + \nu_1)$. Because at each sampling $e(t_k) = 0$, we have

$$\|e_k\| \leq \frac{b\|x(t_k)\| + \bar{d}}{a} (e^{a(t-t_k)} - 1). \quad (4.46)$$

By using this bound, we are now in the position to design the self-triggered sampler that ensures ε -practical stability of the closed loop dynamic (4.44).

The self-triggered sampler we propose is derived by a Lyapunov approach. We consider the Lyapunov candidate $V(x) = x^T P x$, where $P > 0$ is solution of the Lyapunov equation $P(A_0 + B_0 K)^T + (A_0 + B_0 K)P = -Q < 0$ and we define

$$\xi \triangleq \frac{2\lambda_{\max}^P (\|B_0 K\| + \nu_1 + \bar{d})}{\lambda_{\min}^Q - 2\lambda_{\max}^P (\nu_0 + \nu_1)},$$

$$\varepsilon \triangleq \frac{1}{\xi} \left(\delta - \frac{2\lambda_{\max}^P \bar{d}}{\lambda_{\min}^Q - 2\lambda_{\max}^P (\nu_0 + \nu_1)} \right),$$

where λ_{\max}^M and λ_{\min}^M denotes the maximum and minimum eigenvalues of a matrix M , and δ is a positive scalar that we choose to determine ε .

Lemma 4.6. Consider the system (4.41). Let $k_2 > 0$ and $k_1 > 0$ such that $\|e^{(A(\eta)+B(\eta)K)(t-t_k)}\| \leq k_1 e^{\alpha(t-t_k)}$ where $\alpha = k_2 + \nu_0 + \nu_1$. Assume $\alpha < 0$ and let a self-triggered sampler be defined as

$$t_{k+1} = t_k + \gamma(x(t_k), x(t_{k-1}), \tau_k), \quad (4.47)$$

with

$$\gamma(x(t_k), x(t_{k-1}), \tau_k) = \frac{1}{a} \ln \left(1 + \frac{a\varepsilon}{b\|x(t_k)\| + \bar{d}} - \frac{b\|x(t_{k-1})\| + \bar{d}}{b\|x(t_k)\| + \bar{d}} (e^{a\tau_k} - 1) \right) - \tau_{\max}. \quad (4.48)$$

Then, for a sufficiently large δ such that

$$1 \leq \varepsilon \left(\frac{b \max\{k_1\|x(t_0)\|, \varepsilon\} + \bar{d}}{a} (e^{a\tau_{\max}} - 1) \right)^{-1}, \quad (4.49)$$

by applying the control (4.42) at the times given by (4.47), the closed loop system is local ε -practically stable.

We remark that this lemma requires that $\alpha = k_2 + \nu_0 + \nu_1 < 0$, which is only a restriction to the parameter uncertainties. The self-triggered sampler (4.47) exhibits several interesting properties. Given the measurements $x(t_k)$, $x(t_{k-1})$ and the time delay τ_k , it allows us to determine the next sampling time t_{k+1} that ensures ε -practical stability. Note that (4.47) can be used in the cases in which the time delays τ_k are measurable (for example if the packets are time stamped) or not. If the time delays are not measurable, it is always possible to employ the conservative bound $\tau_k = \tau_{\max}$. Finally, the proposed self-triggered sampler is robust with respect to parameters uncertainties and external disturbances of the plant and it ensures a non decreasing sequence of times, i.e. $t_{k+1} - t_k \geq 0, \forall k$.

However, IEEE 802.15.4 imposes a minimum time interval $B.I._{\min}$ between two transmissions, and it must result $t_{k+1} - T_k \geq B.I._{\min}, \forall k$. This means that a self-triggered sampler that is designed without considering the protocol could give instability. More in general, since event-based sampling have no control of the protocol, it also means that it is very difficult to apply event-based sampling strategies on IEEE 802.15.4 NCS.

In the next subsection we investigate the conditions that make self-triggered sampler (4.47) compatible with IEEE 802.15.4.

Stability Condition over IEEE 802.15.4 Networks In this subsection, we give one of the core contribution of the chapter, namely the system-level design of the controller and the communication protocol.

The self-triggered sampler (4.47) decreases as both $\|x(t_k)\|$ and τ_k increase. It depends also on the distance of two consecutive measurements $\|x(t_{k-1})\|$ and $\|x(t_k)\|$. Since we would like to find a bound on the sampling times of the self-triggered sampler so that it is compatible with IEEE 802.15.4, we begin to find the maximum distance between two consecutive measurements $\|x(t_{k-1})\|$ and $\|x(t_k)\|$. This distance depends on the size of the $(k-1)$ -th beacon interval.

By imposing that the measurements are taken when nodes wakes up to receive the beacon from the PAN coordinator, namely imposing $t_k = T_k$, we see that the evolution of the system from time T_k to time T_{k+1} is bounded with

$$\|x(T_{k+1})\| \leq a_{d1}(B.I._k, \tau_k)\|x(T_k)\| + a_{d2}(\tau_k)\|x(T_{k-1})\| + a_{d3}(B.I._k, \tau_k), \quad (4.50)$$

where the terms $a_{d1}(\text{B.I.}_k, \tau_k)$, $a_{d2}(\tau_k)$ and $a_{d3}(\text{B.I.}_k, \tau_k)$ are derived in (Tiberi, Fischione, Johansson and Benedetto 2010).

Because the previous functions are increasing with B.I._k and τ_k , we can find an upper bound for $\|x(T_{k+1})\|$ given by the solution of the following delay discrete time system:

$$\|x(T_{k+1})\| = A_{d1}\|x(T_k)\| + A_{d2}\|x(T_{k-1})\| + A_{d3},$$

where $A_{d1} = a_{d1}(\text{B.I.}_{\max}, \tau_{\max})$, $A_{d2} = a_{d2}(\tau_{\max})$ and $A_{d3} = a_{d3}(\text{B.I.}_{\max}, \tau_{\max})$. We have the following ε -practical stability sufficient condition over IEEE 802.15.4 NCSs:

Theorem 4.7. *Consider the system (4.41) and let the assumptions of Lemma 4.6 hold. Suppose there exists a B.I._{\min} such that*

$$\frac{1}{a} \ln \left(1 + \frac{\varepsilon}{\rho_1} - \frac{\rho_0}{\rho_1} (e^{a\tau_{\max}} - 1) \right) - \tau_{\max} \geq \text{B.I.}_{\min}, \quad (4.51)$$

where

- $\rho_0 = a^{-1}(b \max\{\kappa_1\|x(t_0)\|, \varepsilon\} + \bar{d})$,
- $\rho_1 = a^{-1}(b((A_{d1} + A_{d2}) \max\{\kappa_1\|x(t_0)\|, \varepsilon\} + A_{d3}) + \bar{d})$.

Then using the control (4.42) and the self-triggered sampler (4.47), the system is local ε -practically stable over an IEEE 802.15.4 network.

We remark that Theorem 4.7 captures a tradeoff among the admissible set of initial conditions x_0 , the maximum delay allowed τ_{\max} to transmit plant measurements, the maximum B.I. allowed, the sets of the parameters uncertainties \mathcal{D}_η and the external perturbations \mathcal{D}_d , and the time constants of both the open and the closed loop systems. Hence, in the design of an IEEE 802.15.4 NCS, if Theorem 4.7 applies, then the closed loop system is ε -practically stable and the self-triggered sampler (4.47) can be successfully used.

Because the self-triggered sampler gives larger times as the norm of the state decreases, it could happen that $t_{k+1} - T_k \gg \text{B.I.}_k$ for some k when the norm is sufficiently small. We can increase the beacon interval to reduce the number of transmissions and to increase the inactive periods. In the next section we propose a distributed algorithm to achieve this goal.

Adaptive IEEE 802.15.4 In this subsection, we show how the IEEE 802.15.4 MAC parameters can be adapted so that the self-triggered sampler ensures stability and the energy consumption of the network is reduced. In particular, here we deal with three issues

1. The adaptation of the MAC parameters, namely the duration of the beacon interval, must be coordinated between the plant node and the controller node.
2. The sampling times given by the self-triggered sampler (4.47) must be larger than the minimum beacon interval allowed by the IEEE 802.15.4 standard.
3. The sampling times given by the self-triggered sampler (4.47) must be lower than the maximum beacon interval allowed by the IEEE 802.15.4 standard.

In the following, we investigate these issues and propose Algorithm 1, which summarizes the adaptation mechanism of the IEEE 802.15.4 MAC parameters to the self-triggered strategy.

The times t_k given by the self-triggered sampler (4.47) are hard deadlines by which the state measurements must be taken and transmitted. Theorem 4.7 guarantees $T_k < t_{k+1} < T_{k+1}, \forall k$. However, at time $t_k + \tau_k$, i.e. when t_{k+1} is computed, it could happen that $T_k < t_k < T_{k+1} < T_{k+2} < \dots < T_{k+m} < t_{k+1}$ for some $m > 0$. This means that the nodes may wake up and transmit data even if it is not needed. It is then reasonable to provide an increasing of the k -th beacon interval, so that $T_{k+1} < t_{k+1} < T_{k+2}, \forall k$. An increasing of the beacon interval gives two benefits: a reduction of the number of transmissions, and a reduction of the duty cycle of the $(k + 1)$ -th superframe, thus reducing the energy consumption of the network.

As described in 4.2.1, the standard doesn't allow us to change the k -th superframe parameters at time t with $T_k < t < T_{k+1}$. However, at a time t it is possible to decide the structure of the $(k + 1)$ -th superframe and encapsulate this information in the next beacon packet. To enlarge the $(k + 1)$ -th beacon interval, we use the estimate $\|\hat{x}(T_{k+1})\|$ of $\|x(T_{k+1})\|$, that can be computed by (4.50), and we use the self-triggered sampler (4.47) with

$$\hat{t}_{k+2} = T_{k+1} + \gamma(\hat{x}(T_{k+1}), x(T_k), \tau_k). \quad (4.52)$$

If $T_{k+2} < \hat{t}_{k+2}$ it is then possible to increase the $(k + 1)$ -th beacon interval as we show below by Proposition 4.8.

On the other hand, a beacon interval computed by the self-triggered strategy could be too large. By using the same arguments as above, we can reduce the $(k + 1)$ -th beacon interval if $\hat{t}_{k+2} < T_{k+2}$. It is worth noting that by reducing the beacon interval to $B.I._{\min}$, the self-triggered sampler continues to work correctly as per Theorem 4.7.

A sketch of the algorithm is depicted in Fig. 24 while Algorithm 1 gives a formal explanation.

```

begin
  for each  $\bar{T}_k$  do
    The PAN Coordinator sends a beacon to the plant node;
    At time  $T_k$  the plant node picks the measurement;
    The plant node computes  $\hat{x}(T_{k+1})$  with (4.50);
    The plant node sends data to the PAN Coordinator ;
    The PAN Coordinator computes  $\hat{t}_{k+2}$  by (4.52);
    The PAN Coordinator sets  $B.O._{k+1} = B.O._k + \lfloor \log_2 \left( \frac{\hat{t}_{k+2} - \bar{T}_k}{B.I._k} \right) \rfloor$ ;
    if  $B.O._{k+1} > B.O._{\max}$  then
      |  $B.O._{k+1} = B.O._{\max}$ ;
    end
    The PAN Coordinator includes the value of  $B.O._{k+1}$  in the next beacon packet;
  end
end
  
```

Algorithm 1: Self-triggered control and the adaptation of IEEE 802.15.4 MAC.

Note that Algorithm 1 gives an estimated time \hat{t}_{k+2} such that $T_{k+2} < \hat{t}_{k+2}$. Since it must be also that $T_{k+2} < t_{k+2}$, this is ensured by the following result:

Proposition 4.8. *If the hypothesis of Theorem 4.7 hold, then Algorithm 1 ensures that $t_k < T_{k+1} < t_{k+1}, \forall k$.*

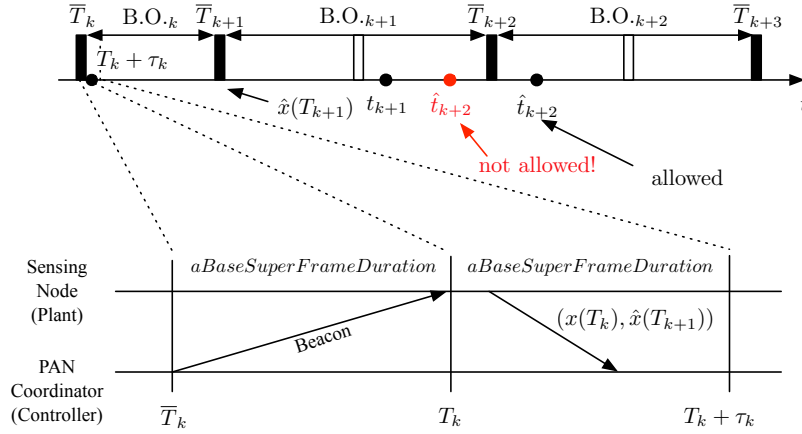

Figure 24. Adaptive IEEE 802.15.4 Algorithm: a) The PAN Coordinator sends the beacon to the plant node at time \bar{T}_k . b) The plant node picks the state measurement at time T_k $x(T_k)$, estimates $\hat{x}(T_{k+1})$ and sends back these data to the PAN Coordinator. c) The coordinator computes \hat{t}_{k+2} and $B.O.k+1$ and encapsulates this value in the next beacon packet, so that the plant node receives the beacon at time \bar{T}_{k+1} and adapts its beacon interval accordingly.

Algorithm 1 respects the IEEE 802.15.4 protocol constraints while ensuring stability. Such algorithm has many benefits in terms of energy consumption and implementation aspects. First, in contrast to a periodic sampling time with, e.g., $B.I._{min}$, which would give much worse energy consumption, it increases the beacon interval. Second, the computations can be distributed to the nodes of the network: the state estimator (4.50) can be implemented at the plant node, while the self-triggered sampler (4.52) can be implemented at the controller. The plant node transmits the values of $x(T_k)$ and $\hat{x}(T_{k+1})$ while the PAN Coordinator updates the control law, computes \hat{t}_{k+2} , and encapsulates the value of $B.O_{k+1}$ in the $(k + 1)$ -th beacon, see Fig. 24.

4.2.3 Simulations

In this section, we report some simulation results that illustrate the proposed self-triggered strategy for IEEE 802.15.4 NCSs. We simulated the scenario of Section 4.2.1 and implemented Algorithm 1. We considered system (4.41) with

$$A(\eta) = \begin{bmatrix} -0.2 + \eta_1 & 1 \\ 0 & 0.05 + \eta_2 \end{bmatrix}, B(\eta) = \begin{bmatrix} 1 + \eta_3 \\ 2 \end{bmatrix}.$$

In this example we used the bound on the matrix exponential given by $\|e^{At}\| \leq k_1 e^{k_2 t}$ with $k_1 = 1$ and $k_2 = 0.5 \lambda_{\max}^{(A_0 + B_0 K) + (A_0 + B_0 K)^T}$, as proposed in (Kågström 1976).

The parameters uncertainty η_1, η_2 and η_3 evolve randomly in the set $[-0.01, 0.01]$ during the simulations, and the maximum value of the external disturbance is set to $\bar{d} = 0.02$. We designed a control $u = Kx$ that places the closed loop nominal system eigenvalues at $\lambda_1 = -0.2$ and $\lambda_2 = -0.1$. We set $x_1(0) = 100, x_2(0) = 70$ as initial conditions. For $aBaseSuperFrameDuration = 4$ ms, a maximum

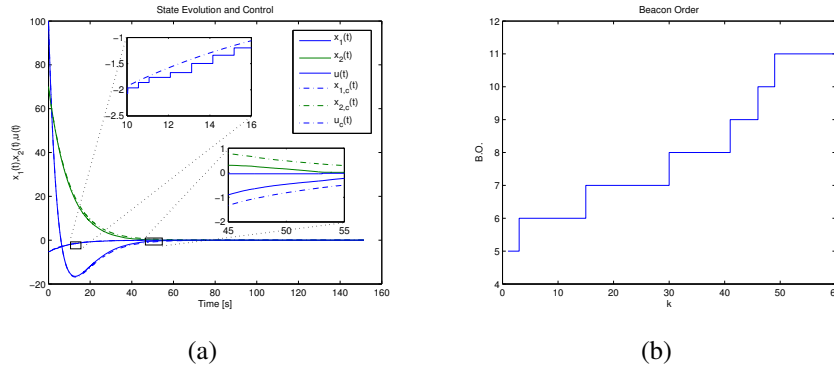

Figure 25. (a) System response and control. The dotted lines denote the system response and the control as obtained by a continuous control $u_c(t) = Kx(t)$, and the continuous lines denote the evolution of the state and the control obtained by our Algorithm 1. (b) IEEE 802.15.4 beacon order adaptation as obtained by our Algorithm 1. On the x-axis, the superframe number is reported.

delay $\tau_{\max} = 0.2$ ms, and $B.O_{\cdot\max} = 11$, the stability condition (4.51) provided a minimum inter sampling time of $\simeq 8.3$ ms $>$ $B.I_{\cdot\min} = aBaseSuperFrameDuration \times 2 = 8$ ms. Thus, the condition (4.51) is verified and the closed loop system is ε -practically stable over the network.

In Fig. 25(a) we report the behavior of the system in the cases when we apply the designed continuous control $u_c(t) = Kx(t)$ and the piecewise constant control $u(t) = Kx(T_k)$, $t \in [T_k + \tau_k, T_{k+1} + \tau_{k+1})$.

The system results ε -practically stable for both controls.

In Fig. 25(b) we reported the adaptation of the beacon order $B.O_k$ as determined by Algorithm 1. Note how the plant node sent measurements over longer time intervals as the state norm decreases. We conclude by noting that Algorithm 1 achieved stability, reduced the number of transmission, and increased the inactive periods of the beacon intervals. A reduction of the network energy consumption was achieved as a consequence.

4.2.4 Conclusions and Future Work

We presented an analysis for networked control systems when the feedback channel is closed over an IEEE 802.15.4 network.

A sufficient condition for the stability over such networks was derived. An algorithm that provides a dynamic adaptation of the protocol parameters to obtain energy saving and stability was proposed.

Future works include the investigation of the fundamental stability conditions for more complex network topologies, possibly with the multihop routing of the RPL protocol (*Routing Over Low power and Lossy networks (roll)* n.d.). We also plan to include systems composed by more plants and controllers that share the same IEEE 802.15.4 network. A first attempt in this direction is in (Tiberi, Fischione, Johansson and Di Benedetto 2011). The problem of scheduling the guaranteed time slots, for each combination of number of sensors and controllers, is under development.

5 Conclusions

In this report, the activity carried out within the work package 5 of FeedNetBack on the topic of energy efficient control and asynchronous control was summarized. We have seen that energy is saved in a NCS by reducing the quality of the data and by limiting the amount of communication in the network. The first chapter of this report focuses on the former, and the rest of this report on the latter.

In the first chapter, a quantizer and the corresponding control law is derived to stabilize a linear system subject to noise. In this contribution, the sampling time of the sensor and the controller is periodic and the communication between the elements is assumed reliable, but the measurement from the sensor to the controller is quantized using a finite alphabet, and the control input applied to the plant is bounded. The derived quantizer and control law show good results in simulation, even for small alphabets.

The other chapters of this report focuses on asynchronous methodologies to save energy. The second chapter introduces the event-based approach which is used to limit the communications in the network to the time instants where a given event occurs. In section 3.1 a radio mode switching policy is introduced. This work addresses a control application where the radio of the sensor node is turn to low consuming modes to save energy. While the sensor keeps measuring the plant state periodically, the measurement is only sent to the controller node if the state of the system leaves a given region. This region is computed to minimize a cost function where the performance of the closed loop and the energy consumed for actuation and communication appear. The proposed solution is optimal with respect to the cost function and is obtained using Dynamic Programming.

In section 3.2, the event-based approach is applied to a monitoring problem. In this contribution, large scale systems are considered where several sensor nodes measure some output of the plant and compute its overall state. The data exchange between the nodes is limited to some neighborhood. The observer structure of each node considers a local Luenberger like observer with a consensus strategy. The convergence (Globally Ultimately Uniformly Bounded is considered) of the estimate is first shown on the periodic case and then extended to the event-based case, where a node only broadcast its own value when a given constraint is violated.

In the third chapter, a second asynchronous approach, the so-called self-triggered approach, is presented. This approach relaxes the periodic evaluation of the event-triggering condition inherent in the event-based approach. Each node decides how long it is going to sleep and does not perform any action between the aperiodic sampling instants. The first contribution, in section 4.1, addresses the problem of controlling a LTI plant with imperfect knowledge of the dynamics and bounded additive disturbance. As for the second contribution, the network is considered between the plant and the controller. The use of the network is reduced by adapting the sampling rate with a self-triggered Lyapunov-based sampling procedure. The next sampling instant is determined online by solving Quadratic Programming. The results, obtained for continuous plant are extended to discrete plant.

In the last contribution, the authors focus on the control of a continuous perturbed linear plant with parameters uncertainties where the communication between the plant and the controller uses the well-known IEEE 802.15.4 protocol. A self-triggering condition is first derived to stabilize the plant without any consideration of the protocol. However, the resulting asynchronous control law is not necessarily compatible with the IEEE 802.15.4 protocol because of the difference between the waking up instant induced by the self-triggering condition and the requirements of the protocol. Therefore, the results are extended to the particular case of the 802.15.4 protocol. Moreover, as an additional technique to save energy, an adaption mechanism is derived to adapt the parameters of the protocol.

References

- A. Bonivento, C. Fischione, L. Necchi, F. Pianegiani, A. Sangiovanni-Vincentelli: 2007, System level design for clustered wireless sensor networks, *IEEE Transactions on Industrial Informatics* pp. 202–204.
- Alriksson, P. and Anders, R.: 2006, Distributed kalman filtering using weighted averaging, *17th International Symposium on Mathematical Theory of Networks and Systems*, Kyoto, Japan.
- Anta, A. and Tabuada, P.: 2008, Self-triggered stabilization of homogeneous control systems, *Proceedings of the American Control Conference*, Seattle, WA, United states, pp. 4129 – 4134.
- Anta, A. and Tabuada, P.: 2010, To sample or not to sample: Self-triggered control for nonlinear systems, *IEEE Transactions on Automatic Control* **55**(9), 2030–2042.
- Årzén, K. E.: 1999, A simple event-based PID controller, *Proceedings of 14th IFAC World Congress*, Beijing, P. R. China, pp. 423–428.
- Azimi-Sadjadi, B.: 2003, Stability of networked control systems in the presence of packet losses, *Proceedings of the 41st Conference on Decision and Control*.
- Bao, L.: 2009, *Control over Low-Rate Noisy Channels*, PhD thesis, Royal Institute of Technology (KTH). TRITA-EE 2009:032.
- Bellman, R. E.: 1957, *Dynamic Programming*, Princeton University Press, Princeton, NJ.
- Bertsekas, D. P.: 2007, *Dynamic Programming and Optimal Control*, Vol. 2, 3rd edn, Belmont, Mass. Athena Scientific.
- Brockett, R. W. and Liberzon, D.: 2000, Quantized feedback stabilization of linear systems, *IEEE Transactions on Automatic Control* **45**(7), 1279–1289.
- Brownfield, M., Fayez, A., Nelson, T. and Davis, N.: 2006, Cross-layer wireless sensor network radio power management, *IEEE Wireless Communications and Networking Conference, WCNC'06*, Vol. 2, pp. 1160–1165.
- Cardoso de Castro, N., Canudas de Wit, C. and Johansson, K. H.: 2010, On energy-aware communication and control co-design in wireless network controlled systems, *2nd IFAC Workshop on Estimation and Control of Networked Systems, NecSys'10*, Annecy France.
- Chatterjee, D., Ramponi, F., Hokayem, P. and Lygeros, J.: 2011, On mean square boundedness of stochastic linear systems with bounded controls. Submitted, <http://control.ee.ethz.ch/index.cgi?page=publications;action=details;id=3774>.
- Cogill, R.: 2009, Event-based control using quadratic approximate value functions, *48th IEEE Conference on Decision and Control*, Shangai, China, pp. 5883–5888.
- Cogill, R., Lall, S. and Hespanha, J.: 2007, A constant factor approximation algorithm for event-based sampling, *American Control Conference, 2007. ACC '07*, pp. 305 –311.

- Delchamps, D. F.: 1990, Stabilizing a linear system with quantized state feedback, *IEEE Transactions on Automatic Control* **35**(8), 916–924.
- Di Marco, P., Park, P., Fischione, C. and Johansson, K. H.: 2010, TREnD: a timely, reliable, energy-efficient and dynamic wsn protocol for control applications, *Proceedings of the Information Communicatoin Conference*.
- Elia, N. and Mitter, S.: 2002, Stabilization of linear systems with limited information, *Automatic Control, IEEE Transactions on* **46**(9), 1384–1400.
- Farina, M., Ferrari-Trecate, G. and Scattolini, R.: 2009, Distributed moving horizon estimation for sensor networks, *1st IFAC Workshop on Estimation and Control of Networked Systems*, Venice, Italy, pp. 126–131.
- Fujioka, H.: 2009, A discrete-time approach to stability analysis of systems with aperiodic sample-and-hold devices, *IEEE Transactions on Automatic Control* **54**(10), 2440–2445.
- Fujioka, H., Nakai, T. and Hetel, L.: 2010, A switched lyapunov function approach to stability analysis of non-uniformly sampled-data systems, *Proceedings of the 2010 American Control Conference*.
- Heemels, W. P. M. H. and van de Wouw, N.: 2011, Stability and stabilization of networked control systems, *Networked Control Systems*, Vol. 406 of *Lecture Notes in Control and Information Sciences*, Springer-Verlag, Berlin, pp. 203–253.
- Hespanha, J. P., Naghshtabrizi, P. and Xu, Y.: 2007, A survey of recent results in networked control systems, *Proceedings of the IEEE* **95**(1).
- Hetel, L., Daafouz, J. and Iung, C.: 2008, Analysis and control of lti and switched systems in digital loops via an event-based modelling, *International Journal of Control* **81**(7), 1125–1138.
- Hokayem, P., Cinquemani, E., Chatterjee, D., Ramponi, F. and Lygeros, J.: 2010, Stochastic receding horizon control with output feedback and bounded control inputs, To appear in *Automatica*, also available at <http://arxiv.org/abs/1004.0793>.
- IEEE: 2006, *Wireless Medium Access Control (MAC) and Physical Layer (PHY) Specifications for Low Rate Wireless Personal Area Networks (LR-WPANs)*, IEEE 802.15.4.
- Imer, O. and Basar, T.: 2005, Optimal estimation with limited measurements, *44th IEEE Conference on Decision and Control, 2005 and 2005 European Control Conference, CDC-ECC'05*, pp. 1029 – 1034.
- Imer, O. and Basar, T.: 2006, To measure or to control: optimal control with scheduled measurements and controls, *American Control Conference, ACC'06*.
- Kågström, B.: 1976, Bound and perturbation bounds for the matrix exponential, *BIT Numerical Mathematics*, pp. 39–57.
- Lincoln, B.: 2003, *Dynamic Programming and Time-Varying Delay Systems*, PhD thesis, Department of Automatic Control, Lund Institute of Technology, Sweden.

- Liu, X. and Goldsmith, A.: 2004, Wireless network design for distributed control, *43rd IEEE Conference on Decision and Control, CDC'04*, Vol. 3, pp. 2823 – 2829.
- Lunze, J. and Lehmann, D.: 2010, A state-feedback approach to event-based control, *Automatica* **46**, 211–215.
- Maestre, J. M., Giselsson, P. and Rantzer, A.: 2010, Distributed receding horizon kalman filter, *49th IEEE Conference on Decision and Control*, Atlanta, GA, USA, pp. 5068 – 5073.
- Maestre, J. M., Muñoz de la Peña, D. and Camacho, E. F.: 2011, Wireless sensor network analysis through a coalitional game: Application to a distributed Kalman filter, *8th IEEE International Networking, Sensing and Control*, Delft, The Netherlands.
- Matveev, A. S. and Savkin, A. V.: 2007, Shannon zero error capacity in the problems of state estimation and stabilization via noisy communication channels, *International Journal of Control* **80**(2), 241–255.
- Matveev, A. S. and Savkin, A. V.: 2009, The problem of stabilization of networked systems under computational power constraints, *European Journal of Control* **15**(3-4), 449–467.
- Mazo, M., Anta, A. and Tabuada, P.: 2009, On self-triggered control for linear systems: guarantees and complexity, *European Control Conference*.
- Mazo, M. and Tabuada, P.: 2008, On event-triggered and self-triggered control over sensor/actuator networks, *47th IEEE Conference on Decision and Control*.
- Millán, P., Orihuela, L., Muñoz de la Peña, D., Vivas, C. and Rubio, F.: 2011, Self-triggered sampling selection with quadratic programming for plants with bounded disturbances, *18th IFAC World Congress. Milano 28 Aug - 2 Sept 2011* **Accepted for publication**.
- Millán, P., Tiberi, U., Fischione, C., D., D. and Rubio, F.: 2012, Decentralized event-based observers for lti networked systems, *Submitted to American Control Conference 2012* .
- Montestruque, L. A. and Antsaklis, P.: 2003, On the model-based control of networked systems, *Automatica* **39**(10), 1837–1843.
- Montestruque, L. A. and Antsaklis, P.: 2004, Stability of model-based networked control systems with time varying transmission times, *IEEE Transactions on Automatic Control* **49**(9), 1562–1572.
- Nair, G. N., Fagnani, F., Zampieri, S. and Evans, R. J.: 2007, Feedback control under data rate constraints: An overview, *Proceedings of the IEEE* **95**(1), 108–137.
- Nocedal, J. and Wright, S. J.: 2006, *Numerical Optimization*, second edn, Springer-Verlag, Berlin.
- Olfati-Saber, R.: 2005, Distributed Kalman filter with embedded consensus filters, *44th IEEE Conference on Decision and Control and the European Control Conference*, Seville, Spain, pp. 8179–8184.

- Olfati-Saber, R.: 2007, Distributed Kalman filtering for sensor networks, *46th IEEE Conference on Decision and Control*, New Orleans, LA, USA, pp. 5492–5498.
- Olfati-Saber, R., Fax, J. A. and Murray, R. M.: 2007, Consensus and cooperation in networked multi-agent systems, *Proceedings of the IEEE* **95**(1), 215–233.
- Olfati-Saber, R. and Murray, R. M.: 2004, Consensus problems in networks of agents with switching topology and time-delays, *IEEE Transactions on Automatic Control* **49**(9), 1520–1533.
- Olfati-Saber, R. and Shamma, J.: 2005, Consensus filters for sensor networks and distributed sensor fusion, *44th IEEE Conference on Decision and Control and the European Control Conference*, Seville, Spain, pp. 6698 – 6703.
- Orihuela, L., Rubio, F. R. and Gómez-Stern, F.: 2009, Model-based networked control systems under parametric uncertainties, *Conference on Control Applications*, Saint Petersburg, Russia.
- Park, P.: 2009, Protocol design for control applications using wireless sensor networks, *Technical Report TRITA-EE 2009:041*, Royal Institute of Technology (KTH). Licentiate Thesis.
- Pemantle, R. and Rosenthal, J. S.: 1999, Moment conditions for a sequence with negative drift to be uniformly bounded in L^r , *Stochastic Processes and their Applications* **82**(1), 143–155.
- Ploplys, N. J., Kawka, P. A. and Alleyne, A. G.: 2004, Closed-loop control over wireless networks, *IEEE Control Systems Magazine* **24**(3), 58–71.
- Quevedo, D. and Ahlen, A.: 2008, A predictive power control scheme for energy efficient state estimation via wireless sensor networks, *47th IEEE Conference on Decision and Control, CDC'08*, pp. 1103 –1108.
- Ramponi, F., Chatterjee, D., Miliadis-Argeitis, A., Hokayem, P. and Lygeros, J.: 2010, Attaining mean square boundedness of a marginally stable stochastic linear system with a bounded control input, *IEEE Transactions on Automatic Control* **55**(10), 2414–2418.
- Routing Over Low power and Lossy networks (roll)*: n.d.
- Sinha, A. and Chandrakasan, A.: 2001, Dynamic power management in wireless sensor networks, *Design & Test of Computers, IEEE* **18**(2), 62–74.
- Sinopoli, B., Schenato, L., Franceschetti, M., Poolla, K., Jordan, M. and Sastry, S.: 2004, Kalman filtering with intermittent observations, *IEEE Transactions on Automatic Control* **49**(9), 1453 – 1464.
- Speranzon, A., Fischione, C. and Johansson, K. H.: 2006, Distributed and collaborative estimation over wireless sensor networks, *45th IEEE Conference on Decision and Control*.
- Speranzon, A., Fischione, C., Johansson, K. H. and Sangiovanni-Vincentelli, A.: 2008, A distributed minimum variance estimator for sensor networks, *IEEE Journal on Selected Areas in Communication* **26**, 609–621.

- Suh, Y. S.: 2008, Stability and stabilization of nonuniform sampling systems, *Automatica* **44**, 3222–3226.
- Sundström, O., Ambühl, D. and Guzzella, L.: 2010, On implementation of dynamic programming for optimal control problems with final state constraints, *Oil Gas Sci. Technol. - Rev. IFP* **65**(1), 91–102.
- Tabuada, P.: 2007, Event-triggered real-time scheduling of stabilizing, *IEEE Transactions on Automatic Control* **52**(9), 1680–1685.
- Tatikonda, S., Sahai, A. and Mitter, S.: 2004, Stochastic linear control over a communication channel, *IEEE Transactions on Automatic Control* **49**(9), 1549–1561.
- Tiberi, U., Fischione, C., Johansson, K. H. and Benedetto, M. D.: 2010, Adaptive self triggered control over 802.15.4 networks, *Technical report*, Royal Institute of Technology, Sweden.
- Tiberi, U., Fischione, C., Johansson, K. H. and Di Benedetto, M. D.: 2011, Self-triggered control of multiple loops over ieee 802.15.4 networks, *50th Conference on Decision and Control*.
- Tipsuwan, Y. and Chow, M.-Y.: 2003, Control methodologies in networked control systems, *Control Engineering Practice* **11**(10), 1099–1111.
- Velasco, M., Marti, P. and Fuertes, J.: 2003, The self triggered task model for real-time control systems, *Work-in-Progress Session of the 24th IEEE Real-Time Systems Symposium (RTSS03)*.
- Walsh, G. C., Beldiman, O. and Bushnell, L. G.: 2001, Asymptotic behavior of nonlinear networked control systems, *IEEE Transactions on Automatic Control* **46**(7), 1093–1097.
- Walsh, G. C., Ye, H. and Bushnell, L. G.: 2002, Stability analysis of networked control systems, *IEEE Transactions on Control Systems Technology* **10**(3), 438–446.
- Wang, X. and Lemmon, M.: 2009, Self-triggered feedback control systems with finite-gain \mathcal{L}_2 stability, *IEEE Transactions on Automatic Control* **54**(3), 452–467.
- Willig, A.: 2008, Recent and emerging topics in wireless industrial communication, *IEEE Transactions on Industrial Informatics* **4**(2), 102–124.
- Xiao, L., Johansson, M., Hindi, H., Boyd, S. and Goldsmith, A.: 2003, Joint optimization of communication rates and linear systems, *IEEE Transactions on Automatic Control* **48**(1), 148–153.
- Xu, Y. and Hespanha, J.: 2005, Estimation under uncontrolled and controlled communications in networked control systems, *44th IEEE Conference on Decision and Control, 2005 and 2005 European Control Conference. CDC-ECC '05*, pp. 842 – 847.
- Yang, T. C.: 2006, Networked control system: a brief survey, *IEE Proceedings on Control Theory and Applications* **153**(4), 403 – 412.
- Yüksel, S.: 2010, Stochastic stabilization of noisy linear systems with fixed-rate limited feedback, *IEEE Transactions on Automatic Control* **55**(12), 2847–2853.