



HAL
open science

A stronger necessary condition for the multistationarity of chemical reaction networks

Sylvain Soliman

► **To cite this version:**

Sylvain Soliman. A stronger necessary condition for the multistationarity of chemical reaction networks. 2013. hal-00772438v4

HAL Id: hal-00772438

<https://inria.hal.science/hal-00772438v4>

Preprint submitted on 3 Apr 2013 (v4), last revised 16 May 2013 (v5)

HAL is a multi-disciplinary open access archive for the deposit and dissemination of scientific research documents, whether they are published or not. The documents may come from teaching and research institutions in France or abroad, or from public or private research centers.

L'archive ouverte pluridisciplinaire **HAL**, est destinée au dépôt et à la diffusion de documents scientifiques de niveau recherche, publiés ou non, émanant des établissements d'enseignement et de recherche français ou étrangers, des laboratoires publics ou privés.

A stronger necessary condition for the multistationarity of chemical reaction networks

Sylvain Soliman

the date of receipt and acceptance should be inserted later

Abstract Biochemical reaction networks grow bigger and bigger, fed by the high-throughput data provided by biologists and bred in open repositories of models allowing merging and evolution. Nevertheless, since the available data is still very far from permitting the identification of the increasing number of kinetic parameters of such models, the necessity of structural analyses for describing the dynamics of chemical networks appears stronger every day.

Using the structural information, notably from the stoichiometric matrix, of a biochemical reaction system, we state a more strict version of the famous Thomas' necessary condition for multistationarity. In particular, the obvious cases where Thomas' condition was trivially satisfied, mutual inhibition due to a multimolecular reaction and mutual activation due to a reversible reaction, can now easily be ruled out.

This more strict condition shall not be seen as some version of Thomas' circuit functionality for the continuous case but rather as related and complementary to the whole domain of the structural analysis of (bio)chemical reaction systems, as pioneered by Chemical Reaction Network Theory.

Keywords Jacobian matrix · Influence graph · Feedback circuit · Multistationarity · Chemical reaction network

Mathematics Subject Classification (2000) 92C42 · 34C10 · 34C23 ·

1 Introduction

In the last thirty years, the conjecture of Thomas (1981) on the necessary presence of a positive circuit for the occurrence of multistationarity has opened a whole field of research.

First on the mathematical side, since it has been proven under various forms, depending on the restrictions on the system: discrete (Richard and Comet 2007; Remy et al. 2008) or continuous (Plahte et al. 1995; Gouzé 1998; Snoussi 1998; Cinquin and Demongeot 2002; Soulé 2003).

But also based on the insight gained from it allowing better modeling and understanding of biochemical networks, especially in the emerging field of Systems Biology.

Sylvain Soliman
Inria Paris-Rocquencourt - Equipe CONTRAINTES
Domaine de Voluceau, Rocquencourt, BP 105
78153 LE CHESNAY CEDEX - FRANCE
E-mail: Sylvain.Soliman@inria.fr

However, if that second aspect is striking in the field of discrete modeling of gene regulatory networks, even the stronger versions of Thomas' necessary conditions published recently (Kaufman et al. 2007) did not have the same impact in the Ordinary Differential Equations (ODE) based modeling community.

This is mostly due to the fact that this necessary condition, the existence of a positive loop in the Jacobian of the ODE system, is almost always satisfied. Indeed, any binary reaction equipped with Mass-Action kinetics will lead to the mutual inhibition of the two substrates, and thus create such a loop (see Fig. 1a).

Even a reversible unary reaction can lead to satisfying the condition, since it induces a mutual activation of the two biochemical species (see Fig. 1b).

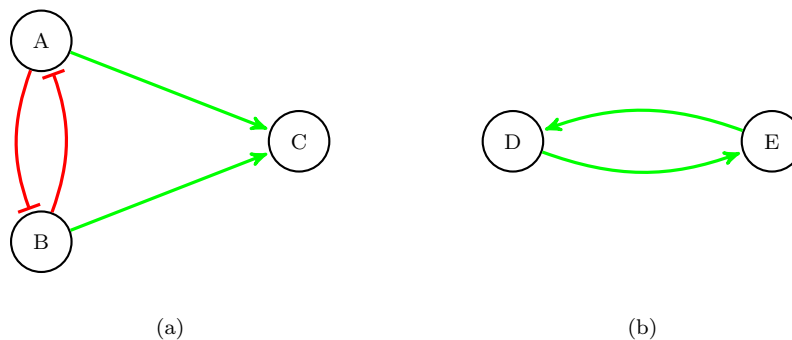

Fig. 1 (a): mutual inhibition resulting from $A + B \Rightarrow C$. (b): mutual activation resulting from $D \Leftrightarrow E$. For clarity, negative self-loops have not been represented

Since many models are still being constructed based on ODEs, the community turned to other types of conditions, especially for purely Mass-Action or Non Auto-Catalytic (NAC) systems (Craciun et al. 2006; Craciun and Feinberg 2005).

Nevertheless, even using these conditions, Craciun and Feinberg (2006) state that enzyme kinetics like $S + E \Leftrightarrow C \Rightarrow P + E$ promote cycles and thus might explain why such systems *might be far more prone than others to exhibit multiple equilibria*.

In this article, after some preliminaries, we give necessary conditions for multistationarity, not restricted to Mass-Action or NAC chemical reaction systems, stronger than Thomas', and local as in Soulé (2003). They show that enzyme kinetics of the above form—Fig. 1 or enzyme kinetics *à la* (Craciun and Feinberg 2006)—do not by themselves create multistationarity-inducing cycles.

Our approach is based on the Directed Species Reaction (DSR) graph as defined in Kaltenbach (2012) (and not the homonym from Banaji and Craciun (2009)) and the related analysis of terms appearing in the Jacobian's determinant. It is *local*, i.e., the existence of a positive loop can be verified for a given point of the phase space. Note that since the local version of Thomas' conjecture for oscillations has been proven false by Richard and Comet (2011), there is no direct generalization of our work to the existence of limit cycles, even using Hurwitz determinants as analogous to principal minors for Hopf bifurcations.

2 Jacobian characterization of multistationarity

Following Soulé (2003) we will use the Gale and Nikaido (1965) univalence theorem and its refinements.

We consider a differentiable map F from Ω , a product of n intervals of \mathbb{R} , to \mathbb{R}^n and study the corresponding system $\dot{x} = F(x)$. Its *Jacobian* matrix, noted J , is defined as usual as follows:

$$J_{ij}(x) = \partial f_i / \partial x_j(x)$$

The *influence graph* associated to J at each point x is the labelled directed graph with vertices $\{x_i \mid 1 \leq i \leq n\}$; an arc (x_i, x_j) if J_{ij} is not null, and the sign of J_{ij} as label.

The graphs depicted in Fig. 1 are influence graphs where the labels are represented as colors and arrow tips: green and pointy tip for a positive sign, red and T-tip for a negative sign.

A *Hamiltonian Hooping* (or *nucleus*) of J is a disjoint collection of cycles of its influence graph, covering all n vertices.

Theorem 1 (Soulé 2003)

Let F be any differentiable map from Ω to \mathbb{R}^n , with Jacobian matrix J . If Ω is open and F has two nondegenerate zeroes in Ω then there exists a in Ω such that some principal minor of $-J(a)$ is negative.

Using the Leibniz formula for determinants that defines them in terms of permutations of the indices of the matrix, and the link between those and hamiltonian hoopings, one then obtains the classical necessary condition on the existence of some a such that there is a positive circuit in $J(a)$.

Note that this result can be extended to the case where Ω is the (closed) positive orthant, when some additional, but commonly accepted in the Systems Biology community, conditions are met. This is the case for instance if F is the function associated with the dynamics of a chemical reaction system with only Mass-Action kinetics (Craciun and Feinberg 2005), or if one is only interested in multistationarity associated to Saddle-node bifurcations.

3 Directed Species-Reaction graph

Let us now consider a (bio)chemical reaction system with n species S_1, \dots, S_n and m reactions R_1, \dots, R_m . Using notations from Kaltenbach (2012) we write:

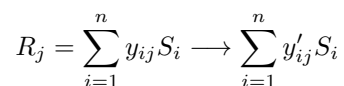

The y and y' represent the stoichiometric coefficients of the reactants and products of the reaction.

The rate law associated with reaction R_j will be written v_j . This defines a dynamical system in the sense of previous section: $\dot{x} = F(x)$ where x_i is the concentration of species S_i and

$$f_i(x) = \sum_j v_j(x) \cdot (y'_{ij} - y_{ij})$$

This kind of systems encompasses most of the Systems Biology models developed nowadays. One can notice for instance that the Systems Biology Markup Language (SBML) of Hucka et al. (2008) can be translated to such reactions by splitting reversible reactions into forward and backward reactions and by including modifiers on both sides of the reaction (they are not affected by it, but do affect it).

Such a system can be represented naturally in a graphical form as a bipartite graph for species and reactions, as depicted in Fig. 2. Arcs can also be labelled with the y and y' in a Petri-net-like manner.

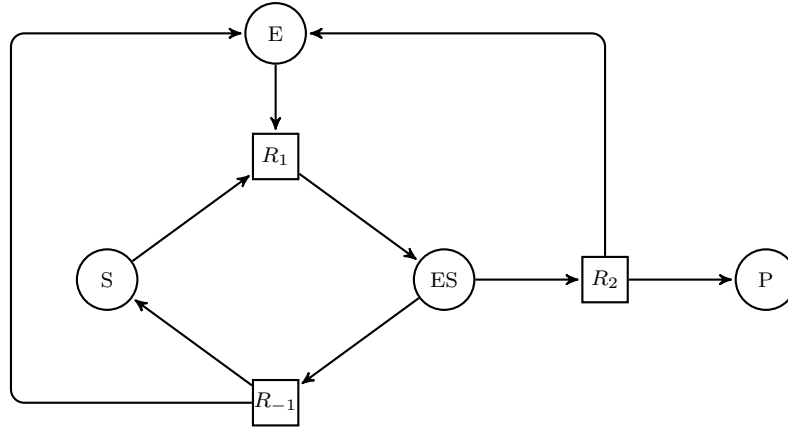

Fig. 2 Bipartite graph representation of the enzymatic reaction: $S + E \rightleftharpoons ES \Rightarrow E + P$. Arcs being all labelled with 1, this label is not shown.

Using the same bipartite vertices but different arcs and labels, it is possible to represent the Directed Species-Reaction (DSR) graph of Kaltenbach (2012). The arcs are now defined and labelled as follows:

$$\begin{aligned}\lambda(S_i, R_j) &= \frac{\partial v_j}{\partial x_i} \\ \lambda(R_j, S_i) &= y'_{ij} - y_{ij}\end{aligned}$$

Note that this is not the DSR graph defined by Banaji and Craciun (2009) since the arcs are always directed and the labels different.

If the label λ is zero, then there is no arc. λ is extended to paths (resp. subgraphs) as the product of the labels of all arcs in the path (resp. subgraph). For a path P , we shall write $\lambda_{SR}(P)$ (resp. $\lambda_{RS}(P)$) for the product of labels considering only species to reaction (resp. reaction to species) arcs.

Intuitively, the λ_{SR} represent the contribution of species to each reaction rate, whereas the λ_{RS} describe the stoichiometric effect of reactions on each species.

Fig. 3 shows the DSR graph for the same chemical reaction network as Fig. 2.

Definition 1 A *Species Hamiltonian Hooping* of the DSR graph is a collection of cycles covering each of the species nodes exactly once.

The set of all species hamiltonian hoopings will be denoted by \mathcal{H} .

Lemma 6.2 of (Kaltenbach 2012) gives a decomposition of the Jacobian in terms of the set \mathcal{H} :

$$\det(J) = \sum_{H \in \mathcal{H}} \sigma(H) \lambda(H) \quad (1)$$

where σ is the *sign* of the species hamiltonian hooping, defined as usual.

Since the DSR graph can of course be restricted to only certain species, the same lemma can be used for any principal minor of the original determinant.

Now thanks to the fact that $\lambda(H) = \lambda_{SR}(H) \lambda_{RS}(H)$, Kaltenbach (2012) groups all species hamiltonian hoopings having the same species-to-reaction arcs using an equivalence relation noted \sim and obtains:

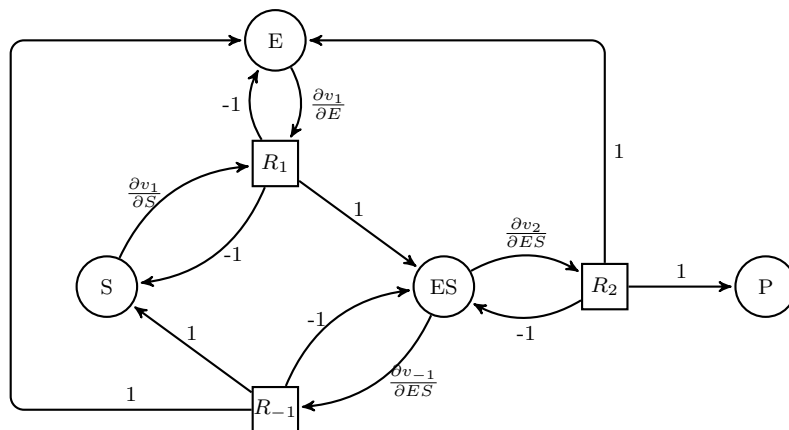

Fig. 3 DSR graph of the same enzymatic reaction: $S + E \rightleftharpoons ES \Rightarrow E + P$.

Theorem 2 (Kaltenbach 2012)

$$\det(J) = \sum_{[H] \in \mathcal{H}/\sim} \Lambda([H]) \lambda_{SR}(H)$$

where Λ is defined as:

$$\Lambda([H]) = \sum_{H' \in [H]} \sigma(H') \lambda_{RS}(H')$$

It is important to notice that, in its original formulation this theorem has a second part and is only stated for systems such that $\forall i, j, \partial v_i / \partial x_j \geq 0$, i.e., the λ_{SR} are always non-negative. These systems are called NAC (Non AutoCatalytic) by Kaltenbach, but the hypothesis does not match the stronger and more usual definition of NAC systems (see for instance (Banaji et al. 2007)) that forbids the production of some species to depend on its concentration. It rather matches the definition of *monotonicity* of Fages and Soliman (2008b,a) and allows the restriction of the sign of an element in the above sum to the different components of Λ .

Nevertheless, since we will only use the decomposition given above and whose proof does not rely on this hypothesis, we will use the theorem in its full generality.

4 Strengthening Thomas' conjecture

Considering Thm. 1 and applying Thm. 2 to each sub-DSR-graph corresponding to a principal minor of $-J$, one can see that a necessary condition for multistationarity is that some term of the sum is negative. This again states the usual condition about the existence of a positive cycle in the influence graph of J .

We will now examine the consequences of the decomposition of this sum more precisely. In particular, we will show that many negative terms can actually be proven to cancel out with other positive terms, leaving us with more specific negative terms (and thus positive circuits) to look for.

Definition 2 The restriction of the system to a species hamiltonian hooping H (noted $|_H$) is the system where reactions $\{R_i \mid i \in I\}$ not appearing in H are omitted.

Since each species appears exactly once in any species hamiltonian hooping, there is one reaction associated to each species by following the outgoing arc of that species. Note however that the same reaction can appear several times, as associated with several different species.

This definition is naturally extended to any function or graph defined by the biochemical system.

As noticed by Kaltenbach in the proof of one of the lemmas preceding Thm. 2, Λ can be computed directly from the stoichiometric matrix $Y' - Y$ of the biochemical system. This observation is useful in proving our first lemma:

Lemma 1 *Let H be a species hamiltonian hooping, if $(Y' - Y)|_H$ is not of full rank, then $\Lambda([H]) = 0$.*

Proof As per Lemma 6.6 of Kaltenbach (2012) we have $\Lambda([H])$ proportional to $\det((Y' - Y)|_H)$, now, if that matrix is not of full rank, its determinant is 0. \square

This allows us to state our main results:

Theorem 3 *Let F be any differentiable map from Ω to \mathbb{R}^n corresponding to a biochemical reaction system. If Ω is open and F has two nondegenerate zeroes in Ω then there exists a in Ω such that:*

1. $J(a)$ contains a positive circuit C ;
2. C is subcycle of some species hamiltonian hooping H with $(Y' - Y)|_H$ of full rank.

Proof Because we share the same hypotheses, we can use Thm. 1 to obtain a and the corresponding negative principal minor. It is then possible to apply Thm. 2 to decompose that minor according to the DSR graph as a sum of terms for each species hamiltonian hooping equivalence class, and this sum must contain a negative term.

Since only positive circuits will lead to negative terms in the usual determinant decomposition, we can now prove the proposition *ab absurdam*. If all negative terms appear only in some $\Lambda([H])$ such that the restriction of the stoichiometric matrix to H is not of full rank, they will be cancelled out by other terms, following Lemma 1. This would lead to a contradiction. \square

Note that the first property, as usual, can be checked on the labelled influence graph, and that the second only cares about the reactions involved in subcycles of H . Thus, one can augment the usual labelling of the influence graph to contain not only the sign but also the reaction used for each arc and obtain enough information. Fig. 4 demonstrates this on the same example as Fig. 2.

Remark that H might not be *hamiltonian* since it is hamiltonian in a subgraph corresponding to the principal minor that is negative.

Let us now apply this theorem to some common cases.

Corollary 1 *A necessary condition for the multistationarity of a biochemical reaction system is that there exists a positive cycle in the influence graph associated to its Jacobian, using at most once each reaction.*

Proof This is a direct consequence of Thm. 3 since a matrix with two identical rows is clearly singular.

It is immediate to check that the mutual inhibition resulting from bimolecular reactions—like that between E and S in our running example or between A and B in Fig. 1—cannot fulfill these necessary conditions, since the same reaction— R_1 in Fig. 4—will be repeated twice.

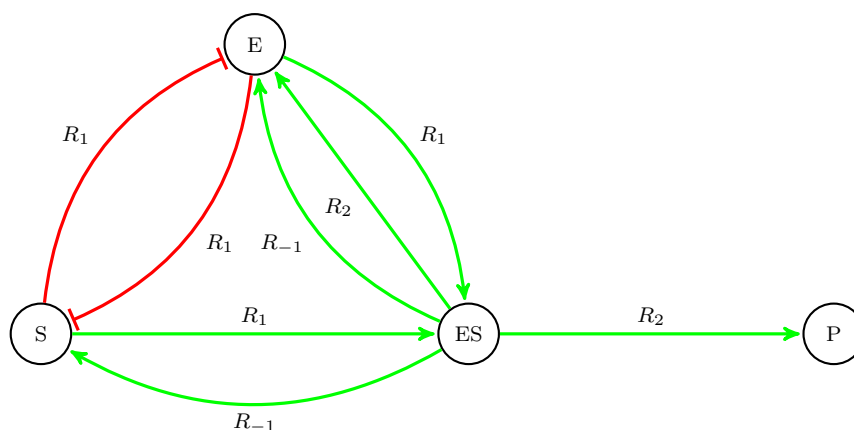

Fig. 4 Influence graph of $S + E \rightleftharpoons ES \rightarrow E + P$. Arcs are labelled by their sign, as usual, but also by the unique reaction involved in order to obtain precisely the same species-species paths as in Fig. 3. Note for instance that there are two positive arcs from ES to E. Negative self-loops are omitted for clarity as in Fig. 1.

Corollary 2 *A necessary condition for the multistationarity of a biochemical reaction system is that there exists a positive cycle in the influence graph associated to its Jacobian, not using both forward and backward directions of any reversible reaction.*

Proof This is once again an immediate consequence of Thm. 3 since a matrix with two opposite rows is clearly singular.

One can thus remark that the mutual activation resulting from reversible reactions—like that between ES and S through R_1 and R_{-1} in our running example or between D and E in Fig. 1—cannot fulfill these necessary conditions.

Note that this corollary corresponds to Lemma 6.9 from (Kaltenbach 2012) but with a much simpler proof involving no rewiring of the influence graph.

Another information that can be extracted from the stoichiometry is the (structural) conservation laws, i.e., P-invariants of the underlying Petri net, or more simply the left kernel of the stoichiometry matrix. Finding all the conservation laws of a biochemical model might be computationally expensive, though in practice that does not seem to be the case (Soliman 2012), but checking if a given set of species are such that their sum is constant is trivial. Based on this observation one can state the following other corollary:

Corollary 3 *A necessary condition for the multistationarity of a biochemical reaction system is that there exists a positive cycle in the influence graph associated to its Jacobian, not using all species involved in a conservation law.*

Proof This is once again an immediate consequence of Thm. 3 since a weighted sum of the columns corresponding to the conservation law is zero. Therefore a matrix containing those columns, even if some rows are forgotten via the selection of some principal minor, will be singular.

One can thus remark that the mutual activation between E and ES, that form a conservation law, through R_1 and R_2 in our running example cannot fulfill the necessary conditions for multistationarity.

The three Corollaries 1, 2 and 3 do rule out most of the obvious cases that used to make Thomas' condition trivially satisfied. In particular, they show that none of the positive circuits of Figure 4 fulfill our stricter condition.

5 Going further

Let us now consider a two-step version of our running example, as is often considered in MAPK cascades and similar signaling pathways.

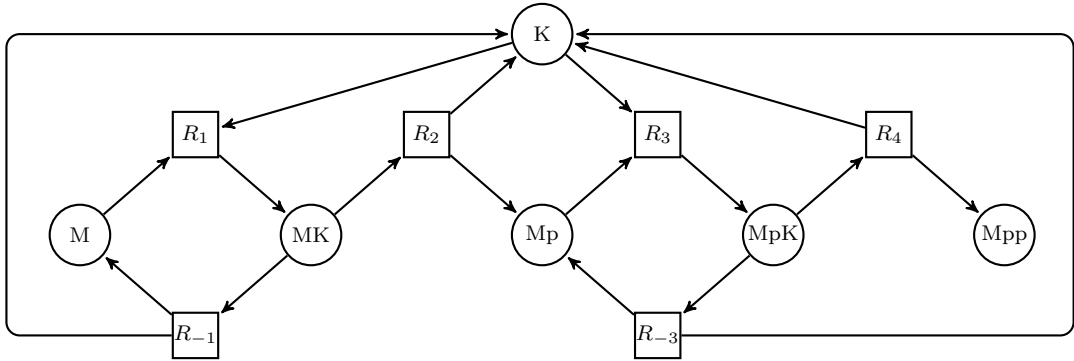

Fig. 5 Bipartite graph representation of the reactions $M + K \rightleftharpoons MK \Rightarrow K + Mp \rightleftharpoons MpK \Rightarrow K + Mpp$. Arcs being all labelled with 1, this label is not shown.

In this example, as before, most positive circuits can be proven not to be enough to make multistationarity possible, some come from reversible reactions like R_1 and R_{-1} . Some are mutual inhibitions from a single reaction like R_3 , some do contain a conservation law, like the big circuit of all forms of the kinase K using R_1, R_2, R_3 and R_4 .

However, some circuits cannot be ruled out that easily. For instance the mutual activation of K and Mp through R_2 and R_3 is now acceptable. Indeed, in the principal minor where only these two species and Mp are considered, the hamiltonian hooping built from the said circuit and the self negative loop on Mp satisfies the hypotheses of Theorem 3.

We present here two ways to rule out this case too by transforming the system without changing the number of steady states, as noted by Soulé (2003).

5.1 Changing the sign of some f_i

First, one can multiply by -1 some of the f_i without affecting the number of steady states of the system. Let us denote by I the subset of $1, \dots, n$ containing such indices.

This corresponds to a transformation of our reaction system where for each species of I , we exchange its stoichiometry as reactant and as product in each reaction, without modifying the rate of the reactions. In mathematical terms, for all i in I we exchange all y_{ij} and y'_{ij} , but all v_j remain untouched. This is possible since in Theorem 2 we took care not to use any hypothesis on the v_j .

The resulting labelled reaction graph is the same as before but with the color (i.e., sign) of the arcs ending in species of I reversed. Any such graph should actually fulfill our conditions in order for the original system to be able to produce multistationarity.

Corollary 4 *A necessary condition for the multistationarity of a biochemical reaction system is that there exist positive cycles fulfilling condition 2 of Theorem 3 in the influence graph corresponding to its Jacobian, **and** in any graph obtained from it choosing a set of species and by reversing the sign of all arcs that have as target some species belonging to that set.*

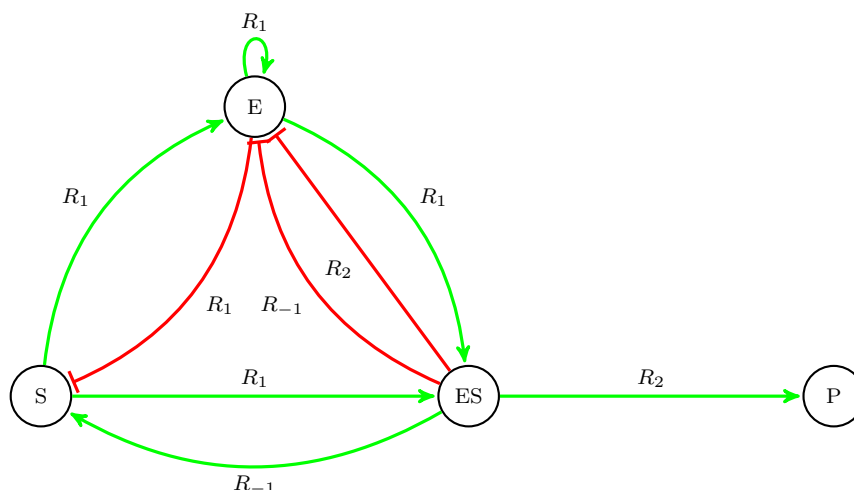

Fig. 6 Influence graph of Fig. 4 but with arcs ending in $\{E\}$ inverted. Note that the self-loop on E has become positive. All other positive cycles contain either twice R_1 or both R_1 and R_{-1} .

Figure 6 shows the result of choosing $I = \{E\}$ in our initial example. It should be noted that there is now a positive loop on E since it had a negative loop beforehand. When trying to prove that a system cannot exhibit multistationarity, it might thus be worth restricting the search for an I to sets that contain at least some of the vertices belonging to the positive circuit that satisfies our hypotheses in the initial graph, and to sets that do not contain any vertex that had a negative self-loop in the initial graph.

In the new example, since both K and MK have negative self-loops, Corollary 4 cannot rule out the circuit.

5.2 Permuting the indices of some f_i

Another transformation of the system that does not change its number of steady states is to multiply the Jacobian by a permutation, i.e., to permute the indices of some f_i .

In biochemical system terms, this can be done by applying the permutation to the species appearing in the reactions (as products or reactants), and thus to the y_{ij} and y'_{ij} but not to the rates v_j .

This transforms only the species-to-reaction arcs of the DSR graph, rewiring them according to the permutation. In the labelled influence graph, the signs and reaction labels do not change, but the arcs are rewired such that their target corresponds to the image by the permutation. All such graphs should once again fulfill our conditions in order for the original system to be able to exhibit multistationarity.

Corollary 5 *A necessary condition for the multistationarity of a biochemical reaction system is that there exist positive cycles fulfilling condition 2 of Theorem 3 in the influence graph corresponding to its Jacobian, **and** in any graph obtained from it choosing a permutation of the species and by rewiring the arcs' target according to the permutation.*

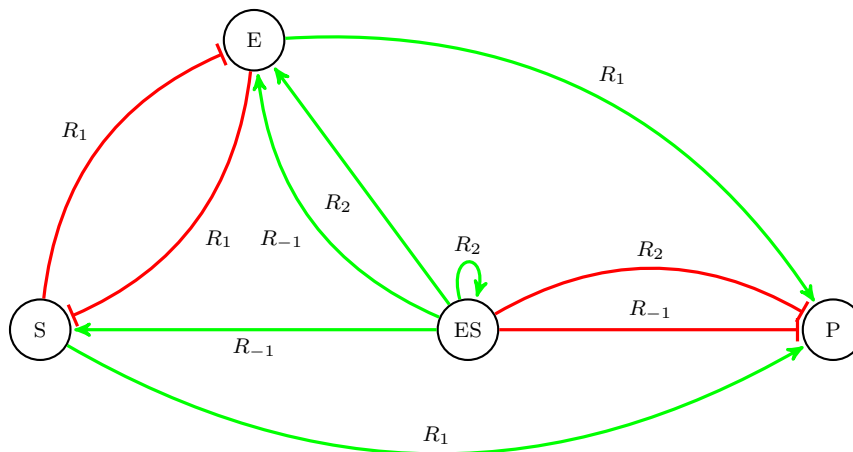

Fig. 7 Influence graph of Fig. 4 but with arcs ending in P and ES substituted. Resulting negative self loops are, as usual, not shown, but note that the negative arcs from ES to P corresponds to negative self loops on ES in the original graph.

Figure 7 shows the result of choosing a permutation of ES and P in our initial example. It should be noted that there is now a positive loop on ES since there was a positive arc from it to P beforehand. When trying to prove that a system cannot exhibit multistationarity, it might thus be worth restricting the search for a permutation to those that do not map a vertex to any other vertex such that the first one has a positive arc to it.

Actually, as noted in Soulé (2003) the two above corollaries can be combined.

Figure 8 shows that by choosing the permutation of K and Mpp in our new example, and by changing the sign on K there is no more positive cycle belonging to a species hamiltonian hooping of full rank. This proves that the system cannot exhibit multistationarity.

6 Conclusion

Using the structural information, notably from the stoichiometric matrix, of a biochemical system, we have been able to state a more strict version of the famous Thomas' necessary condition for multistationarity.

Of course, since we have made no hypothesis on the kinetic rate functions, one can easily represent any dynamical system as such biochemical reactions. Typically one would then have one reaction for each variable with rate corresponding to its derivative. In this case the supplementary hypothesis of our theorems collapse, leaving us with the usual conditions. However for more usual biochemical systems it brings a concrete difference, as illustrated by Cor. 1, 2 or 3, and if necessary their application to many transforms of the influence graph as seen in Corollaries 4 and 5.

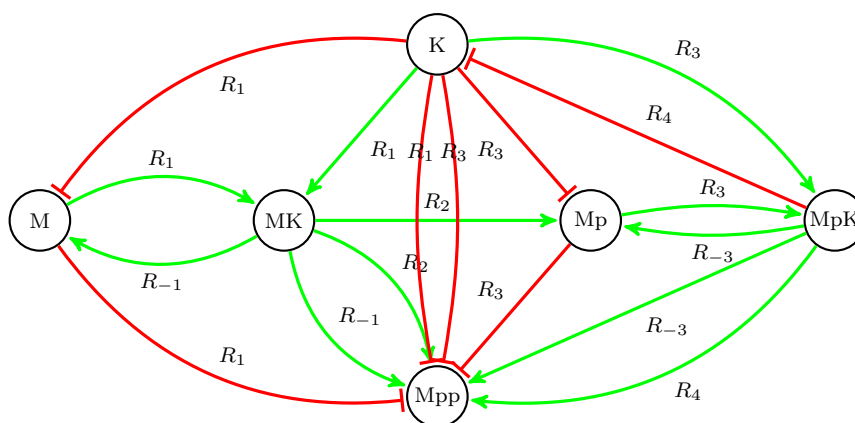

Fig. 8 Influence graph of Fig. 5 but with arcs ending in K and Mpp substituted, and then the only arc ending in K changed of sign. Resulting negative self loops are, as usual, not shown, but note that the negative arcs from K to Mpp corresponds to the negative self loops on K in the original graph. All positive circuits remaining can be ruled out by one of our corollaries as being a possible source of multistationarity.

In particular, the obvious cases where Thomas' condition was trivially satisfied, as illustrated by Fig. 1 and Fig. 4, can now easily be ruled out.

The results are local (i.e., the cycle does exist for some a in the phase space) since they rely on local theorems as was the case in Soulé (2003). Since the other Thomas' condition, on oscillations, is not (Richard and Comet 2011) one cannot directly apply the same reasoning we used to Hurwitz Determinants. It might still be worth investigating, for instance when the signs of the influences in the labelled influence graph are known to be constant.

The same locality argument makes it difficult to interpret our stronger condition as some version of Thomas' circuit functionality for the continuous case. It is rather related and complementary to the whole domain of the structural analysis of (bio)chemical reaction systems, as pioneered by Chemical Reaction Network Theory. As such, we believe that our stronger necessary condition is enough to make circuit analysis a more worthwhile tool in the arsenal of the structural analyst of biochemical systems.

Acknowledgements We would like to thank Steven Gay, a Ph.D. student in our team, who was the first to formulate the conjecture proven in this article, as well as its variant on oscillations. We also thank Christophe Soulé for very interesting discussions that have led to the whole Section 5. Finally we thank the whole Contraintes team for numerous fruitful discussions on this topic.

References

- M. Banaji, P. Donnell, and S. Baigent. P matrix properties, injectivity, and stability in chemical reaction systems. *SIAM Journal on Applied Mathematics*, 67(6):1523–1547, 2007.
- Murad Banaji and Gheorghe Craciun. Graph-theoretic approaches to injectivity and multiple equilibria in systems of interacting elements. *Communications in Mathematical Sciences*, 7(4):867–900, 2009.
- Oliver Cinquin and Jacques Demongeot. Positive and negative feedback: striking a balance between necessary antagonists. *Journal of Theoretical Biology*, 216(2):229–241, 2002.
- Gheorghe Craciun and Martin Feinberg. Multiple equilibria in complex chemical reaction networks: I. the injectivity property. *SIAM Journal on Applied Mathematics*, 65(5):1526–1546, 2005.
- Gheorghe Craciun and Martin Feinberg. Multiple equilibria in complex chemical reaction networks: II. the species-reaction graph. *SIAM Journal on Applied Mathematics*, 66(4):1321–1338, 2006.

- Gheorghe Craciun, Yangzhong Tang, and Martin Feinberg. Understanding bistability in complex enzyme-driven reaction networks. *PNAS*, 103(23):8697–8702, 2006. doi: 10.1073/pnas.0602767103.
- François Fages and Sylvain Soliman. From reaction models to influence graphs and back: a theorem. In *Proceedings of Formal Methods in Systems Biology FMSB'08*, number 5054 in Lecture Notes in Computer Science. Springer-Verlag, February 2008a. doi: 10.1007/978-3-540-68413-8_7.
- François Fages and Sylvain Soliman. Abstract interpretation and types for systems biology. *Theoretical Computer Science*, 403(1):52–70, 2008b. doi: 10.1016/j.tcs.2008.04.024.
- David Gale and Hukukane Nikaido. The jacobian matrix and global univalence of mappings. *Mathematische Annalen*, 159:81–93, 1965. ISSN 0025-5831. doi: 10.1007/BF01360282.
- J.-L. Gouzé. Positive and negative circuits in dynamical systems. *Journal of Biological Systems*, 6:11–15, 1998.
- Michael Hucka, Stefan Hoops, Sarah M. Keating, Le Novère Nicolas, Sven Sahle, and Darren Wilkinson. Systems biology markup language (SBML) level 2: Structures and facilities for model definitions. *Nature Precedings*, December 2008. ISSN 1756-0357. doi: 10.1038/npre.2008.2715.1.
- Hans-Michael Kaltenbach. A unified view on bipartite species-reaction and interaction graphs for chemical reaction networks. arXiv, October 2012. URL <http://arxiv.org/abs/1210.0320>.
- M. Kaufman, C. Soulé, and R. Thomas. A new necessary condition on interaction graphs for multistationarity. *Journal of Theoretical Biology*, 248:675–685, 2007.
- Erik Plahte, Thomas Mestl, and Stig W. Omholt. Feedback loops, stability and multistationarity in dynamical systems. *Journal of Biological Systems*, 3(02):409–413, 1995.
- Elisabeth Remy, Paul Ruet, and Denis Thieffry. Graphic requirements for multistability and attractive cycles in a boolean dynamical framework. *Advances in Applied Mathematics*, 41(3):335–350, 2008. doi: 10.1016/j.aam.2007.11.003.
- Adrien Richard and Jean-Paul Comet. Necessary conditions for multistationarity in discrete dynamical systems. *Discrete and Applied Mathematics*, 155:2403–2413, 2007.
- Adrien Richard and Jean-Paul Comet. Stable periodicity and negative circuits in differential systems. *Journal of Mathematical Biology*, 63(3):593–600, 2011. doi: 10.1007/s00285-010-0388-y.
- El Houssine Snoussi. Necessary conditions for multistationarity and stable periodicity. *Journal of Biological Systems*, 6:3–9, 1998. doi: 10.1142/S0218339098000042.
- Sylvain Soliman. Invariants and other structural properties of biochemical models as a constraint satisfaction problem. *Algorithms for Molecular Biology*, 7(15), May 2012. doi: 10.1186/1748-7188-7-15.
- Christophe Soulé. Graphic requirements for multistationarity. *ComplexUs*, 1:123–133, 2003.
- René Thomas. On the relation between the logical structure of systems and their ability to generate multiple steady states or sustained oscillations. *Springer Ser. Synergetics*, 9:180–193, 1981.