



HAL
open science

Cutting force and EMG recording for ergonomics assessment of meat cutting tasks: influence of the workbench height and the cutting direction on muscle activation levels

Charles Pontonnier, Mark de Zee, Afshin Samani, Georges Dumont, Pascal Madeleine

► To cite this version:

Charles Pontonnier, Mark de Zee, Afshin Samani, Georges Dumont, Pascal Madeleine. Cutting force and EMG recording for ergonomics assessment of meat cutting tasks: influence of the workbench height and the cutting direction on muscle activation levels. ASME 2012 11th Biennial Conference On Engineering Systems Design And Analysis (ESDA2012), Jul 2012, Nantes, France. hal-00762797

HAL Id: hal-00762797

<https://inria.hal.science/hal-00762797v1>

Submitted on 5 Feb 2013

HAL is a multi-disciplinary open access archive for the deposit and dissemination of scientific research documents, whether they are published or not. The documents may come from teaching and research institutions in France or abroad, or from public or private research centers.

L'archive ouverte pluridisciplinaire **HAL**, est destinée au dépôt et à la diffusion de documents scientifiques de niveau recherche, publiés ou non, émanant des établissements d'enseignement et de recherche français ou étrangers, des laboratoires publics ou privés.

**DRAFT : CUTTING FORCE AND EMG RECORDINGS FOR ERGONOMICS
ASSESSMENT OF MEAT CUTTING TASKS: INFLUENCE OF THE WORKBENCH
HEIGHT AND THE CUTTING DIRECTION ON MUSCLE ACTIVATION LEVELS**

Charles Pontonnier*, **Georges Dumont**
IRISA-VR4i

Antenne de Bretagne de l'ENS Cachan
Rennes, France

Email: {charles.pontonnier,georges.dumont}@irisa.fr

Mark de Zee,

Afshin Samani , Pascal Madeleine

Center for Sensory-Motor Interaction

Aalborg University

Aalborg, Denmark

Email : {mdz,asamani,pm}@hst.aau.dk

ABSTRACT

Repetitive arm movement and force exertion are common in meat cutting tasks and often lead to musculoskeletal disorders. In this study, the effects of the workbench height and the cutting direction on the levels of muscular activation of the upper extremity during meat cutting tasks were investigated. Seven subjects performed 4 trials of 20s each at the 4 different heights (0 cm, -10 cm, -20 cm and -30 cm below the elbow height), alternating two cutting directions. Activation levels of upper extremity muscles (biceps brachii, triceps long head, deltoideus anterior, deltoideus medialis and upper trapezius) and cutting forces were recorded synchronously. Then the trends of the normalized activations with regard to the workplace design parameters (table height and cutting direction) were computed. Results showed that the optimal configuration is a partially related to the task, whereas motor control strategies have also an influence on it. The present results provide new key information about the effects of workbench heights during a repetitive meat cutting task and a complete assessment protocol to analyse workstation design parameters influence on muscles activation levels.

KEYWORDS

Trend, Spatial activation, Slaughterhouse, Musculoskeletal disorders, Task assessment

INTRODUCTION

Meat cutting tasks performed in slaughterhouses are highly related to the development of musculoskeletal disorders (MSD) [1]. This can be explained by the presence of many of the highly-reported physical risk factors like repetitive arm movements, strenuous work, relative short work cycle duration, insufficient rest, static posture and cold temperature [2,3]. The most common location for these disorders among butchers is the neck-shoulder region. The etiology of MSD is poorly understood, therefore studies assessing the biomechanics of cutting tasks in greater detail have potential to explain the complex inter-relations between internal (sleep propensity, level of performance,...) and external (workstation design, physical and social environment) risk factors [4, 5]. The main part of the literature analysing the cutting force is based on relative simple force assessment as only the resulting force was measured [6, 7]. Indeed assessing the resulting cutting forces in relation with representative synergistic muscle activations exerted by the worker during the task is necessary. McGorry [8] has designed a knife instrumented with strain gauges to record reactive forces and grip moments. This knife led to a more precise estimation of the intensity level of the task. However, no knife measuring force in 3D has to our knowledge been used in combination with electromyographic measurement. Such an experimental design has the potential to estimate the muscle activation levels during a cutting task and to assess the influence of workplace design parameters on those activations.

*Address all correspondence to this author.

The present study aims at providing data for a complete analysis of the cutting force and the activation of representative synergistic muscles in relation with the workbench height and the cutting direction. The study also aimed at analysing the trend of relative activations (normalized to the cutting task force and the cutting task duration) to define the best workstation configuration.

First are presented the experimental setup and the methods used to define the activation trends with regard to the workplace design parameters (table height and cutting direction). Then complete results of a study on seven subjects are analysed and discussed. At last a conclusion provides information on the implication of such study in the design of workplaces.

EXPERIMENTAL SETUP

Experimental protocol

Figure 1 shows an overview of the experimental setup. Seven subjects (age : 29 ± 5 years old, height: 182 ± 8 cm, weight: 77 ± 16 kg) participated to the experimentation. Each subject was standing in front a workbench that represents the workspace. The table height was set up to be at the same height as the elbow for a neutral position of the arm (recommended height for light work [9]). Two main directions of cutting were designed on the work plane, i.e. arm flexion and a combination of arm internal rotation and abduction. Figures 1 and 2 illustrate the directions of cutting with respect to the surface of the workbench. The subject was asked to perform cutting tasks in these two directions for 20 seconds corresponding to approximately 10 cycles in line with [6]. The subject alternated both directions without any speed constraint. The subject repeated this motion at 4 different heights. The first height (reference height) corresponds to the elbow height for a neutral position of the arm (0 cm). The other heights are respectively -10 cm, -20 cm and -30 cm below this reference position. The 4 trials were realized in a randomized order to prevent any cross-over effect.

To obtain realistic cutting forces, a standard oscilloscope was providing a visual feedback to the subject. Two grooves were designed on the workplane to ensure that the cutting direction was constant. This setup ensured to obtain a resulting cutting force of 30-50 N in average. This value was close to the one observed in previous studies about cutting tasks [7, 10].

Instrumented knife

The knife was based on the instrumentation of a 3D force sensor (FS6, AMTI, Watertown, MA, USA). The applied forces to the force transducer were recorded as sketched in figure 3. The directions of force exertion were denoted as the "x-direction" for F_x , the "y-direction" for F_y and the "z-direction" for F_z (3). Force signals were low-pass filtered (10.5 Hz) and ampli-

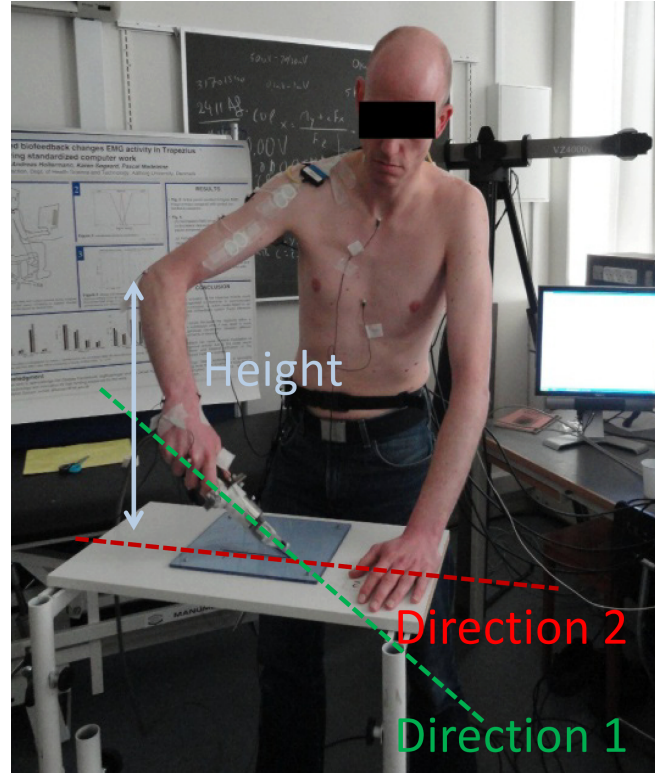

FIGURE 1. EXPERIMENTAL SETUP.

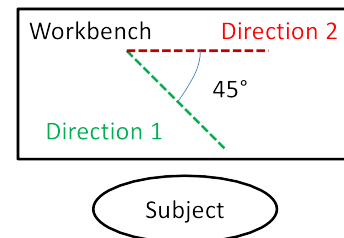

FIGURE 2. CUTTING DIRECTIONS DEFINITION.

fied 2000 times. The signals were A/D converted and sampled at 60 Hz (12 bits A/D converter, Nidaq 6024, National Instruments, Austin, TX, USA) and recorded through a custom made program in LabView 8.2 (National Instruments, Austin, TX, USA). A visual feedback on cutting force was provided to the experimenter with an oscilloscope.

The knife has been designed, as shown in figure 3, with respect to the following constraints:

- The blade had to have the shape of real knife. It was assumed that only the tip of the blade was used during cutting;
- The knife had to be handled as a real knife. The handle

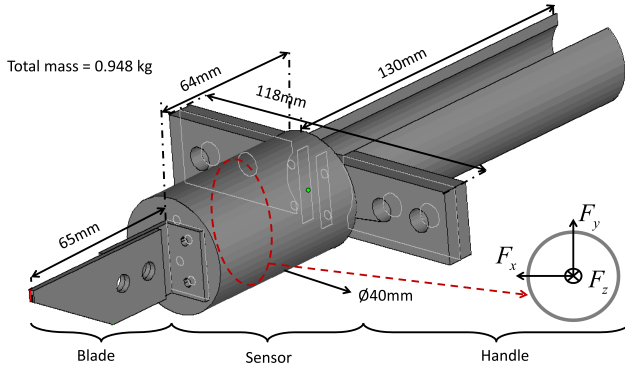

FIGURE 3. INSTRUMENTED KNIFE.

diameter was the same as the one of real slaughter knife and a tennis grip was added to facilitate grasping;

- The knife had to do the same weight as a real knife, however this was not possible due to the weight of the 3D force sensor. The instrumented knife weighted about 0.95 kg. Real knives weigh about [0.2, 0.6]kg. The weight difference was taken into account in the analysis model;
- The knife had to be rigid enough in order to avoid bending issues during the cutting task. Most parts of the blade were realized in steel ;
- In the same way, all parts were designed to be easily replaced;
- The motion of the knife had to be captured. Three target locations were defined on it, allowing the definition of the global location and orientation of the knife.

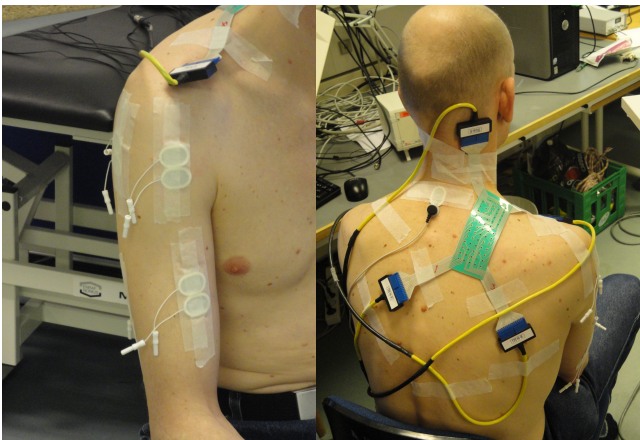

FIGURE 4. SURFACE EMG PLACEMENT.

Surface EMG logging

In order to understand the influence of workplace design parameters on muscle loads, surface electromyographic (EMG) data was collected.

A 64-channel matrix was used to collect the muscle activity of the upper part of the trapezius. The part of the skin covered by the grid was slightly abraded with abrasive paste (Medic-Every, Parma, Italy). The grid was then placed on the muscle with the 4th row aligned on the cervical vertebra C7-acromion line, parallel to the muscle fibre direction [11]. The lateral edge of the grid was 10 mm medial to the identified innervations zone. 30 μ l of conductive gel was inserted with a gel dispenser (model Eppendorf, Multiette plus, Hamburg, Germany) into the cavities of the adhesive electrode grid to ensure proper electrode-skin contact. A reference electrode was placed at C7. Moreover, 4 bipolar channels were used to collect EMG from the deltoideus medialis, deltoideus anterior, biceps brachii and triceps long head (Figure 4) with bipolar surface electrodes (Neuroline 720, Ambu, Denmark). Bipolar surface electrodes were aligned (inter-electrodes distance: 2 cm) on abraded ethanol-cleaned skin along the direction of the muscle fibers. Bipolar electrodes were placed with respect to anatomical landmarks. The EMG signals were amplified 2000 times (128-channel surface EMG amplifier, SEA64, LISiN-OT Bioelectronica, Torino, Italy), band-pass filtered [5-500 Hz] and sampled at 2048 Hz (National Instrument, 12 bits acquisition board, Austin, USA).

METHODS

EMG pre-processing

First EMG Signals were rectified and low pass filtered (4 Hz). Then, in order to obtain a good approximation of the activation, a cross-correlation between the resulting cutting force (computed directly from the 3D force signal during the task) and each EMG signal (coming from each EMG electrode) was computed. The maximal correlation obtained for a positive lag (less than 200 milliseconds) was defined from this cross-correlation and the corresponding lag was assumed to be the electromechanical delay between the muscle excitation and the muscle force (figure 5). Delayed EMG signals were assumed to be a good approximation of the muscle activations (the values obtained here were consistent with the ones reported in the literature [12–16], comprised between [30, 150] ms).

The 64-channel matrix signals were not processed in the same way, because the electromechanical delay depends on the spatial location of the measurement channels. Therefore the EMG signals coming from the matrix were not delayed. Moreover, The trapezius muscle is a prime mover and stabilizer of the shoulder [17], and one can assume that its role is mainly postural during this task (as other monitored muscles are prime movers of the upper extremity).

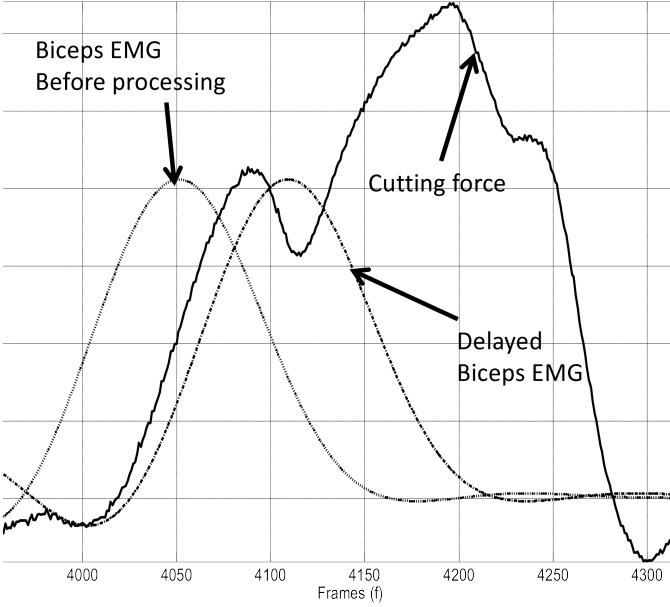

FIGURE 5. EMG DELAY PROCESSING.

Trial processing

To assess the influence of workplace design parameters (workbench height and cutting direction), cutting phases in direction 1 and 2 were isolated trial per trial. Figure 6 shows the

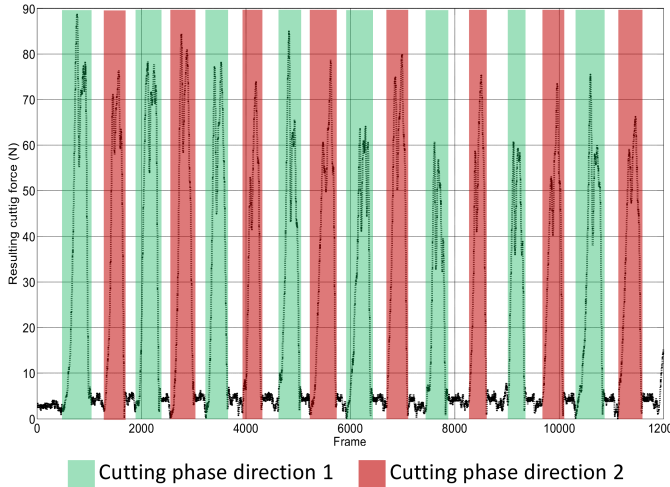

FIGURE 6. CUTTING PHASES IDENTIFICATION.

different phases reported on a sample trial. Start and end of the cutting phases were identified as a local minimum before a drastic increase (start) or decrease (end) of the cutting force. It also

TABLE 1. TRIAL OUTPUTS.

Output	Unit	Dim
Mean resulting force d1	N	[1x1]
Mean resulting force d2	N	[1x1]
Mean duration d1	s	[1x1]
Mean duration d2	s	[1x1]
Mean biceps activation d1	mV	[1x1]
Mean biceps activation d2	mV	[1x1]
Mean triceps activation d1	mV	[1x1]
Mean triceps activation d2	mV	[1x1]
Mean deltoideus anterior activation d1	mV	[1x1]
Mean deltoideus anterior activation d2	mV	[1x1]
Mean deltoideus medialis activation d1	mV	[1x1]
Mean deltoideus medialis activation d2	mV	[1x1]
Mean Trapezius spatial activation d1	mV	[13x4]
Mean Trapezius spatial activation d2	mV	[13x4]
Mean Trapezius activation d1	mV	[1x1]
Mean Trapezius activation d2	mV	[1x1]

enabled to compute the cutting phases durations, designed as D_j^i in the next section. For this trial, 8 phases for direction 1 and 8 phases for direction 2 were identified.

Then, for all of these phases, the mean resulting cutting force and the mean EMG values were computed. Those values were grouped as direction 1 and direction 2 means, and averaged for the whole trial.

For the 64-channel matrix, recording the activity of the trapezius, a mean was done for each bipolar channel during the cutting phases. A spatial [13x4] representation of the mean activation of the trapezius during the task was then obtained. An average of the [13x4] activation map was computed to obtain a similar signal as bipolar electrodes ones. This approach was similar to the one developed in [18].

Table 1 shows the trial outputs obtained after processing (all the means are computed \pm SD).

Relative changes computation

Bipolar electrodes Once the outputs computed for all trials, results were normalized to a (*direction, height*) reference (corresponding to a $MEAN_{TASK}$ normalization, as described in

[19]). In this study, the chosen reference was (*direction 1, 0 cm*). To take into account the fact that the task duration and the mean resulting force was varying from one trial to another, the normalized activations were computed as in equation 1.

$${}^kR_j^i = \frac{{}^kA_j^i \cdot \frac{F_0^1 \cdot D_0^1}{F_j^i \cdot D_j^i} - {}^kA_0^1}{{}^kA_0^1} \quad (1)$$

Where ${}^kR_j^i$ was the relative change of the activation ${}^kA_j^i$ of the muscle k at (*direction i, height j cm*). F_j^i was the mean cutting force and D_j^i was the mean duration of the task at (*direction i, height j cm*). The difference in terms of duration and force were taken into account with the confidence factor called α_j^i , defined in equation 2.

$$\alpha_j^i = \frac{F_0^1 \cdot D_0^1}{F_j^i \cdot D_j^i} \quad (2)$$

α_j^i quantified the difference between two configurations in terms of cutting force and cutting task duration. It represented the amount of work performed by the subject during the cutting task.

64-channel matrix The change of activation of the trapezius was obtained by computing a relative change with regard to (*direction 1, 0 cm*) for each channel separately, as reported in equation 3.

$${}^{Trap}R_{S_j^i}(x,y) = \frac{{}^{Trap}A_j^i(x,y) \cdot \frac{F_0^1 \cdot D_0^1}{F_j^i \cdot D_j^i} - {}^{Trap}A_0^1(x,y)}{{}^{Trap}A_0^1(x,y)} \quad (3)$$

Where (x,y) represents the position of the channel on the matrix. The global change is also a [13x4] spatial representation of the change of activation of the trapezius. A spatial mean was then computed to obtain a single scalar representing change from one configuration to another :

$${}^{Trap}R_j^i = \frac{1}{51} \sum_{x=1}^4 \sum_{y=1}^{13} {}^{Trap}R_{S_j^i}(x,y) \quad (4)$$

Mean spatial entropy during the task and y-position of the barycentre of the activation map were also computed, as defined

in [18, 20]. Mean spatial entropy of the activation map is expressing the heterogeneity of the activation patterns, whereas y-position of the barycentre is an indicator of muscle fatigue development in relation with a specific task.

Statistics

Cutting direction (*Dir*, set to 1 and 2) and table height (*Hei*, set to 0 cm, -10 cm, -20 cm and -30 cm) were introduced as factors in a full-factorial repeated measure analysis of variance (ANOVA) for the cutting phase characteristics (cutting phase duration (D_j^i) and mean cutting force (F_j^i)), the bipolar relative variations (biceps (${}^{Bic}R_j^i$), triceps (${}^{Tri}R_j^i$), deltoideus anterior (${}^{DAnt}R_j^i$) and deltoideus medialis (${}^{DMed}R_j^i$)) and the 64-channel matrix variations (trapezius mean activation change (${}^{Trap}R_j^i$), Y-position of the barycentre of the activation map (${}^{Bar}Y_{pos}$) and mean spatial entropy (SEnt) as dependent variables. The level of significance was set to $p < 0.05$.

RESULTS

Figure 7 shows a comparison of the activation patterns recorded during a complete cycle (consisting in "Cut in direction 1"- "Hold the knife"- "Cut in direction 2"- "Hold the knife") at 4 different workbench heights for subject 1. Activations were normalized to the maximum recorded - all cycles pooled. Trapezius activation corresponds to the average of the [13x4] map at each frame. Patterns have similar shape from one height or one direction to another, but amplitudes vary a lot. Deltoideus anterior seems to be involved in the motion (as its action tends to stabilize the cutting force level after its generation), whereas other muscles have a role in the cutting force generation (as their patterns are synchronised with the cutting force arise).

Table 2 shows the results of the full-factorial repeated measure analysis of variance conducted as presented in the methods section. Significant results are highlighted in bold and followed by *. Cutting phase characteristics analysis shows that the resulting cutting force F_j^i is significantly influenced by the cutting direction and the workbench height, whereas duration D_j^i is not. Bipolar relative variations are also affected by the cutting direction (${}^{Bic}R_j^i$, ${}^{Tri}R_j^i$), the workbench height (${}^{Bic}R_j^i$, ${}^{Tri}R_j^i$, ${}^{DAnt}R_j^i$), or the interaction of both factors (${}^{Bic}R_j^i$, ${}^{DMed}R_j^i$). At last 64-channel variations are influenced by the cutting direction (${}^{Trap}R_j^i$, ${}^{Bar}Y_{pos}$ and SEnt). Entropy SEnt is also affected by the workbench height.

An overview of the cutting tasks mean durations and mean cutting intensities with regard to the cutting direction and the workbench height is presented figure 8. The mean cutting force remains in a range in accordance with [7, 10], i.e. between 30 and 50 N in average. Also, duration remains constant in average

TABLE 2. WITHIN-SUBJECT REPEATED MEASURES ANOVA.

Dependent variables	Factors					
	Direction (<i>Dir</i>)		Height (<i>Hei</i>)		<i>Dir x Hei</i>	
	F	p	F	p	F	p
Cutting characteristics						
D_j^i	0,95	0,37	0,91	0,46	0,29	0,83
F_j^i	26,2*	0,002	5,9*	0,005	1,24	0,32
Bipolar relative variations						
$Bic R_j^i$	36.51*	< 0.001	63.2*	< 0.001	3.27*	0.04
$Tri R_j^i$	17.70*	0.006	18.11*	< 0.001	2.89	0.06
$DAnt R_j^i$	3.33	0.12	43.1*	< 0.001	0.59	0.63
$DMed R_j^i$	0,76	0.42	2.61	0.08	5,06*	0,01
64-channel variations						
$Trap R_j^i$	45.07*	< 0.001	2.5	0.09	2.18	0.13
$Bar Y_{pos}$	9.32*	0.02	2.28	0.11	0.29	0.83
$SEnt$	15.71*	0.007	4.52*	0.02	2.33	0.11

whereas exerted cutting force seems to increase when the workbench height decreases, and remains higher in direction one than in direction 2, in accordance with the ANOVA results shown in table 2.

Figure 9 shows the relative change in muscle activations recorded with the bipolar electrodes (biceps brachii, triceps long head, deltoideus anterior and deltoideus medialis) with regard to the workbench height for both cutting directions (direction one in green, direction 2 in pink). For biceps, triceps and deltoideus anterior, activations trend to decrease when the workbench height decreases independently of the subject, in accordance with the ANOVA results (table 2). For the deltoideus medialis, activation increase in average when the workbench height decrease. However, according to the ANOVA results (table 2), the results are only affected by the combination between height and direction, and are deeply related to the way the subject is performing the task. Direction has also an influence on biceps and triceps activation. Direction 1 leads to less activation than direction 2.

Figure 10 shows the relative change of upper trapezius activation recorded with the 64-channel matrix (resp. trapezius relative activation change, y-position of the barycenter, and average matrix entropy). The relative variation of trapezius activation highlights the inter-subject variability. The cutting direction 1 leads to less activation than cutting direction 2.

Y-position of the barycentre presents a significant shift in the caudal direction for the cutting direction 1. Average matrix entropy is affected by both direction and height. The entropy increases significantly when the workbench height decreases, and direction 1 leads to a higher entropy than direction 2.

Results indicates that :

- Direction 1 leads in general to lower muscle activation levels than direction 2. Moreover, direction 1 tends to increase the barycentre y-position shift of the trapezius activity and the average matrix entropy.
- Height decrease tend to lower the muscle activation levels, excepted for the deltoideus medialis, even if for this muscle the differences between subjects prevents a firm conclusion. Height also enables to increase the trapezius activation spatial entropy.

DISCUSSION

This study aimed at analysing the influence of the workbench height and the cutting direction on muscle activation levels. An trend analysis with regard to a configuration of reference was conducted. The trends of cutting force, cutting duration and muscle activation levels of prime movers muscles and

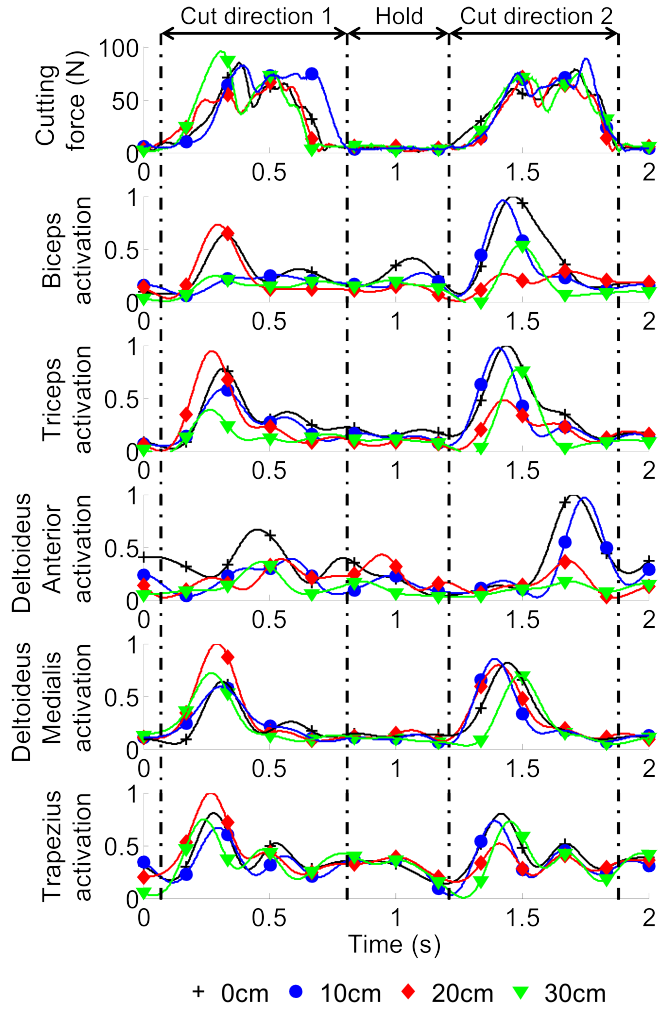

FIGURE 7. COMPARISON OF TRIAL-NORMALIZED ACTIVATION PATTERNS FOR A COMPLETE CYCLE WITH REGARD TO THE WORKBENCH HEIGHT (SAMPLE SUBJECT 1).

postural muscles (respectively biceps brachii, triceps long head, deltoideus anterior, deltoideus medialis and trapezius) revealed that cutting direction and height have a significant influence on muscle activation levels. Individual differences in motor control strategies were also found.

The task described here is not an exact copy of a real meat cutting task, but involves some of the well-acknowledged physical risk factors associated with this work, like repetitive arm movements, strenuous, relative short work cycle duration and static posture [2, 3]. As the phases within the task were not standardized in terms of time, duration really depends on the subjects' appreciation (see figure 8). Those differences can explain the reported activation for the deltoideus medialis during the task. Most of the variance observed for this activation is ex-

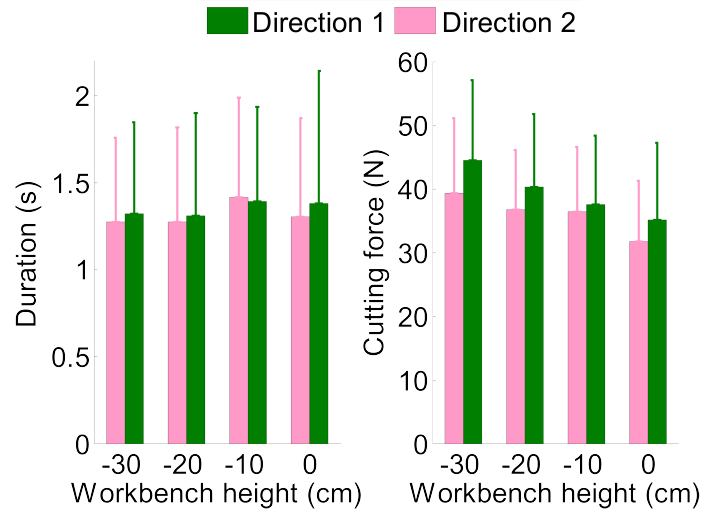

FIGURE 8. TASKS DURATIONS AND AVERAGE CUTTING FORCES FOR SUBJECT 1.

plained by the subject's motor strategies and not by the height and direction parameters as expected.

Recorded activation patterns (figure 7) showed that biceps, triceps, deltoideus medialis and trapezius are involved in force generation, whereas deltoideus anterior is mostly activated at the end of the cutting phases, playing a role in force stabilization. For the trapezius, this observation is in contradiction with the fact that it is commonly considered as playing an important role in supporting the body posture and in movements of the head and shoulders during a number of tasks, e.g. stabilization of the shoulder joint to allow precise manipulations. Deltoideus anterior and biceps have a non-negligible activation during the cutting phases (higher than during holding phases), whereas their action is mechanically counter-productive (they counter the joint torques necessary to generate the cutting force). As those muscles activate with regard to the synergistic muscles (that are the triceps and deltoideus medialis), this co-contraction can be assumed as an action of stabilization of the knife during the task. Subjects had to maintain the knife in the grooves during the cutting phases. It required maintaining a level of co-contraction to increase the stability of the upper limb during the task, as it has been already shown in [21, 22]. Co-contraction also increases limb stiffness, and minimizes the perturbing effects of forces arising from limb dynamics [23]. It corresponds to the co-contraction role reported in several EMG studies about control of the upper extremity [21, 24–29].

As motor control strategies are affected by task learning [30, 31], experience within a task realization mostly leads to a reduction of co-contraction levels. The hypothesis is that the Central Nervous System (CNS) regulates co-contraction and hence

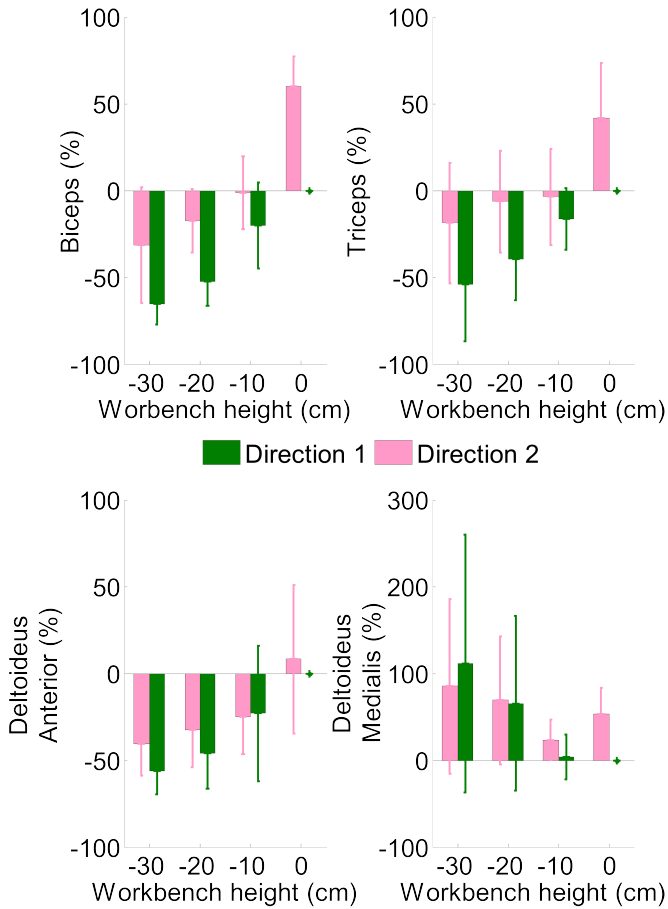

FIGURE 9. RELATIVE VARIATIONS OF RECORDED BIPOLAR ACTIVATIONS.

limb stiffness as a way to facilitate movement accuracy. Co-contraction gradually decreases with practice because the CNS tends to define an internal motor strategy implying only synergistic muscles [21]. This assumption is in line with previous studies of standardized meat cutting tasks processes. In [32], results showed that workers with experience have a motor control strategy implying less variability, a smaller range of motion and more complexity than inexperienced workers. On the contrary, [33], experienced workers compared with novices were characterized by large size of variability. This aspect is of importance as motor strategies of experienced workers can be radically different from the ones reported here. This issue needs to be taken into account when changing parameters such as workbench height.

Assessing kinematics during the task can be very helpful to understand the recorded changes. Actually, the analysis of the shoulder motion during the task show important changes in shoulder internal rotation for direction 2 [34]. It can explain that for equivalent levels of resulting forces, direction 1 is asking less

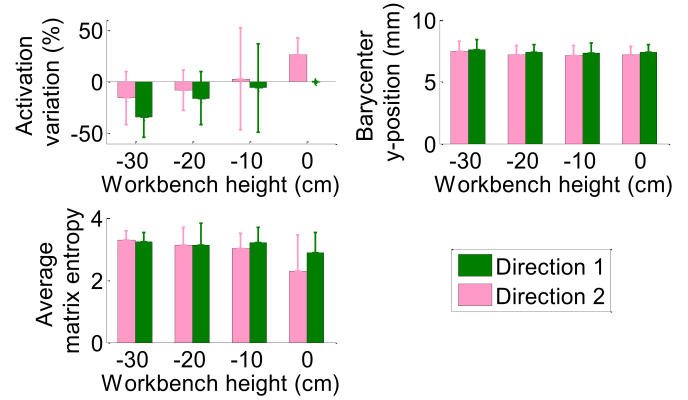

FIGURE 10. RELATIVE VARIATIONS, Y-POSITION OF BARYCENTER AND AVERAGE MATRIX ENTROPY OF TRAPEZIUS SPATIAL ACTIVATION.

muscle activation than direction 2. It also explains why the deltoides anterior is active during the end of the cutting events in direction 2, as it is a prime mover of the shoulder internal rotation.

The main limitation of the present study concern population size. The full-factorial repeated measures ANOVA conducted in the study is based on data following a normal distribution. This condition was not fulfilled and resulted in type II error. To circumvent that limitation, we only discussed the reported significant differences. A larger population size has to be investigated to validate the results of this first study.

CONCLUSION

In this study, the changes of recorded EMGs during meat cutting tasks with regard to two workplace design parameters, i.e. the table height and the cutting direction, were investigated. A complete experimental set-up, enabling the synchronous recording of activations of muscles involved in the upper extremity and cutting force was described. Then a method to analyse the relative change of muscle activations with respect to the workplace configuration was introduced. Results of an experimentation involving seven subjects showed that workbench height and cutting direction have both an influence on muscle loads. Limitations were reported in terms of population and subjects level of experience. Finally, this method of analysis will be used to validate musculoskeletal models, as presented in [35] with hybrids methods, as presented in [36, 37]. As quantitative assessment of such models remains difficult, trend analysis can be a serious alternative to evaluate their accuracy [38]. The use of musculoskeletal models as motion analysis tools, coupled with Virtual Reality tools [39] might be an important opportunity for a systematic assessment of ergonomics during the design of a workplace.

REFERENCES

- [1] OSHA, E., 2007. "Lighten the load". *Magazine of the European Agency for Safety and Health at Work*.
- [2] Sommerich, C. M., McGlothlin, J., and Marras, W. S., 1993. "Occupational risk factors associated with soft tissue disorders of the shoulder: a review of recent investigations in the literature". *Ergonomics*, **36**, pp. 697–717.
- [3] Bernard, B. P., 1997. "Musculoskeletal disorders and workplace factors : a critical review of epidemiologic evidence for work-related musculoskeletal disorders of the neck, upper extremity and low back". *Cincinnati, OH: US Department of Health and Human Services*.
- [4] Madeleine, P., and Farina, D., 2008. "Time to task failure in shoulder elevation is associated to increase in amplitude and to spatial heterogeneity of upper trapezius mechanomyographic signals". *European Journal of Applied Physiology*, **102**, pp. 325–333.
- [5] Madeleine, P., Mathiassen, S. E., and Arendt-Nielsen, L., 2008. "Change in the degree of motor variability associated with experimental and chronic neck-shoulder pain during a standardized repetitive arm movement.". *Experimental Brain Research*, **185**, pp. 689–698.
- [6] Madeleine, P., Lundager, B., Voigt, M., and Arendt-Nielsen, L., 1999. "Shoulder muscle coordination under chronic and experimental neck-shoulder pain: An occupational pain study". *European Journal of Applied Physiology*, **79**, pp. 127–140.
- [7] Jull-Kristensen, B., Fallentin, N., Hansson, G. A., Madeleine, P., Andersen, J. H., and Ekdahl, C., 2002. "Physical workload during manual and mechanical deboning of poultry". *International Journal of Industrial Ergonomics*, **29**, pp. 107–115.
- [8] McGorry, R. W., 2001. "A system for the measurement of grip forces and applied moments during hand tool use". *Applied Ergonomics*, **32**, pp. 271–279.
- [9] McCormik, E. J., and Sanders, M. S., 1987. *Human Factors in engineering and design*.
- [10] McGorry, R. W., Dowd, P. C., and Dempsey, P. G., 2003. "Cutting moments and grip forces in meat cutting operations and the effect of knife sharpness". *Applied Ergonomics*, **34**, pp. 375–382.
- [11] Jensen, C., and Westgaard, R. H., 1997. "Functional subdivision of the upper trapezius during low-level activation". *European Journal of Applied Physiology*, **76**, pp. 335–339.
- [12] Cavanagh, P., and Komi, P., 1979. "Electromechanical delay in human skeletal muscle under concentric and eccentric contractions". *European Journal of Applied Physiology and Occupational Physiology*, **42**, pp. 159–163.
- [13] Vos, E., Harlaar, J., and van Ingen Schenau GJ, 1991. "Electromechanical delay during knee extensor contractions.". *Medicine and Science in Sports and Exercise*, **23(10)**, pp. 1187–1193.
- [14] van Dieën, J., Thissen, C., van de Ven, A., and Toussaint, H., 1991. "The electro-mechanical delay of the erector spinae muscle: influence of rate of force development, fatigue and electrode location". *European Journal of Applied Physiology and Occupational Physiology*, **63**, pp. 216–222.
- [15] Staudenmann, D., Kingma, I., Stegeman, D. F., and van Dieën, J. H., 2005. "Towards optimal multi-channel emg electrode configurations in muscle force estimation: a high density emg study". *Journal of Electromyography and Kinesiology*, **15(1)**, pp. 1 – 11.
- [16] Staudenmann, D., Roeleveld, K., Stegeman, D. F., and van Dieën, J. H., 2010. "Methodological aspects of semg recordings for force estimation - a tutorial and review". *Journal of Electromyography and Kinesiology*, **20(3)**, pp. 375 – 387.
- [17] Westgaard, R., 1988. "Measurement and evaluation of postural load in occupational work situations". *European Journal of Applied Physiology*, **57**, pp. 291–304.
- [18] Samani, A., Holtermann, A., SÅgaard, K., and Madeleine, P., 2010. "Active biofeedback changes the spatial distribution of upper trapezius muscle activity during computer work". *European Journal of Applied Physiology*, **110**, pp. 415–423.
- [19] Adrian, and Burden, 2010. "How should we normalize electromyograms obtained from healthy participants? what we have learned from over 25 years of research". *Journal of Electromyography and Kinesiology*, **20(6)**, pp. 1023 – 1035.
- [20] Farina, D., Leclerc, F., Arendt-Nielsen, L., Buttelli, O., and Madeleine, P., 2008. "The change in spatial distribution of upper trapezius muscle activity is correlated to contraction duration". *Journal of Electromyography and Kinesiology*, **18(1)**, pp. 16 – 25.
- [21] Gribble, P., Mullin, L., Cothros, N., and Mattar, A., 2003. "Role of cocontraction in arm movement accuracy". *J Neurophysiol*, **89(5)**, pp. 2396–2405.
- [22] Osu, R., Kamimura, N., Iwasaki, H., Nakano, E., Harris, C. M., Wada, Y., and Kawato, M., 2004. "Optimal impedance control for task achievement in the presence of signal-dependent noise". *Journal of Neurophysiology*, **92(2)**, pp. 1199–1215.
- [23] Osu, R., and Gomi, H., 1999. "Multijoint muscle regulation mechanisms examined by measured human arm stiffness and emg signals". *Journal of Neurophysiology*, **81(4)**, pp. 1458–1468.
- [24] Latash, M., 1992. "Independent control of joint stiffness in the framework of the equilibrium-point hypothesis". *Biological Cybernetics*, **67**, pp. 377–384.
- [25] Milner, T., and Cloutier, C., 1994. "Compensation for mechanically unstable loading in voluntary wrist movement". *Experimental Brain Research*, **93**, pp. 522–532.

- [26] Franklin, D. W., Osu, R., Burdet, E., Kawato, M., and Milner, T. E., 2003. "Adaptation to stable and unstable dynamics achieved by combined impedance control and inverse dynamics model". *Journal of Neurophysiology*, **90**(5), pp. 3270–3282.
- [27] Franklin, D., Burdet, E., Osu, R., Kawato, M., and Milner, T., 2003. "Functional significance of stiffness in adaptation of multijoint arm movements to stable and unstable dynamics". *Experimental Brain Research*, **151**, pp. 145–157.
- [28] Bazzucchi, I., Sbriccoli, P., Marzattinocci, G., and Felici, F., 2006. "Co-activation of the elbow antagonist muscles is not affected by the speed of movement in isokinetic exercise". *Muscle and Nerve*, **33**(2), pp. 191–199.
- [29] Doheny, E. P., Lowery, M. M., Fitzpatrick, D. P., and O'Malley, M. J., 2008. "Effect of elbow joint angle on force-EMG relationships in human elbow flexor and extensor muscles". *Journal of Electromyography and Kinesiology*, **18**(5), pp. 760–770.
- [30] Thoroughman, K. A., and Shadmehr, R., 1999. "Electromyographic correlates of learning an internal model of reaching movements". *The Journal of Neuroscience*, **19**(19), pp. 8573–8588.
- [31] Osu, R., Franklin, D. W., Kato, H., Gomi, H., Domen, K., Yoshioka, T., and Kawato, M., 2002. "Short- and long-term changes in joint co-contraction associated with motor learning as revealed from surface emg". *Journal of Neurophysiology*, **88**(2), pp. 991–1004.
- [32] Madeleine, P., and Madsen, T., 2009. "Changes in the amount and structure of motor variability during a deboning process are associated with work experience and neck-shoulder discomfort". *Applied Ergonomics*, **40**(5), pp. 887–894.
- [33] Madeleine, P., Voigta, M., and Mathiassen, S. E., 2008. "The size of cycle-to-cycle variability in biomechanical exposure among butchers performing a standardised cutting task". *Ergonomics*, **51**(7), pp. 1078–1095.
- [34] Pontonnier, C., de Zee, M., Samani, A., Dumont, G., and Madeleine, P., 2011. "Meat Cutting Tasks Analysis using 3D Instrumented Knife and Motion Capture". In 15th Nordic-Baltic Conference on Biomedical Engineering and Medical Physics, IFMBE Proceedings, Vol. 34, pp. 144–147.
- [35] Pontonnier, C., de Zee, M., Samani, A., Dumont, G., and Madeleine, P., 2011. "Trend Validation of a Musculoskeletal Model with a Workstation Design Parameter". In proceedings of : Technical Group on Computer Simulation Symposium 2011, pp. 83–84.
- [36] Pontonnier, C., and Dumont, G., 2009. "Inverse Dynamics Method using Optimisation Techniques for the Estimation of Muscle Forces Involved in the Elbow Motion". *International Journal on Interactive Design and Manufacturing (IJIDeM)*, **3**, pp. 227–235.
- [37] Pontonnier, C., and Dumont, G., 2010. "From Motion Capture to Muscle Forces in the Human Elbow Aimed at Improving the Ergonomics of Workstations". *Virtual and Physical Prototyping*, **5**, pp. 113–122.
- [38] Lund, M., de Zee, M., Andersen, M., and Rasmussen, J., 2012. "On validation of multibody musculoskeletal models". *Journal of Engineering in Medicine*, **226**, pp. 82–94.
- [39] Bidault, F., Chablat, D., Chedmail, P., and Pino, L., 2001. "Distributed approach for access and visibility task under ergonomic constraints with a manikin in virtual reality environment". In Proceedings of the 10th IEEE International Workshop on Robot and Human Communication, pp. 32–37.