



HAL
open science

Computational quest for understanding the role of astrocyte signaling in synaptic transmission and plasticity

Maurizio de Pittà, Vladislav Volman, Hugues Berry, Vladimir Parpura, Andrea Volterra, Eshel Ben-Jacob

► To cite this version:

Maurizio de Pittà, Vladislav Volman, Hugues Berry, Vladimir Parpura, Andrea Volterra, et al.. Computational quest for understanding the role of astrocyte signaling in synaptic transmission and plasticity. *Frontiers in Computational Neuroscience*, 2012, 6, pp.68. 10.3389/fncom.2012.00098 . hal-00762313v1

HAL Id: hal-00762313

<https://inria.hal.science/hal-00762313v1>

Submitted on 6 Dec 2012 (v1), last revised 21 Dec 2012 (v2)

HAL is a multi-disciplinary open access archive for the deposit and dissemination of scientific research documents, whether they are published or not. The documents may come from teaching and research institutions in France or abroad, or from public or private research centers.

L'archive ouverte pluridisciplinaire **HAL**, est destinée au dépôt et à la diffusion de documents scientifiques de niveau recherche, publiés ou non, émanant des établissements d'enseignement et de recherche français ou étrangers, des laboratoires publics ou privés.

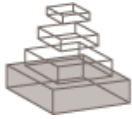

Computational quest for understanding the role of astrocyte signaling in synaptic transmission and plasticity

Maurizio De_Pitta_, Vladislav Volman, Hugues Berry, Vladimir Parpura, Andrea Volterra and Eshel Ben-Jacob

| | |
|--------------------------------|--|
| Journal Name: | Frontiers in Computational Neuroscience |
| ISSN: | 1662-5188 |
| Article type: | Review Article |
| First received on: | 23 Apr 2012 |
| Revised on: | 12 Nov 2012 |
| Frontiers website link: | www.frontiersin.org |

Computational quest for understanding the role of astrocyte signaling in synaptic transmission and plasticity

Maurizio De Pittà¹, Vladislav Volman^{2,3,4}, Hugues Berry⁵, Vladimir Parpura^{6,7}, Andrea Volterra⁸ and Eshel Ben-Jacob^{1,9,10,*}

1. School of Physics and Astronomy, Tel Aviv University, 69978 Ramat Aviv, Israel
2. Center for Theoretical Biological Physics, University of California at San Diego, La Jolla, CA 92093-0319, USA
3. Computational Neurobiology Laboratory, The Salk Institute, La Jolla, CA 92037, USA
4. L-3 Applied Technologies: Simulation, Engineering & Testing, 10770 Wateridge Circle, Suite 200, San Diego, CA 92121, USA
5. BEAGLE, INRIA Rhône-Alpes, Université de Lyon, LIRIS, UMR5205, 69603 Villeurbanne, France
6. Department of Neurobiology, University of Alabama, Birmingham, AL 35242, USA
7. Department of Biotechnology, University of Rijeka, 51000 Rijeka, Croatia
8. Department of Basic Neurosciences, University of Lausanne, Rue du Bugnon 9, CH-1005 Lausanne, Switzerland
9. Center for Theoretical Biological Physics, Rice University, Houston, TX 77005-1827, USA
10. Research & Development Unit, Assaf Harofeh Medical Center, 70300 Zerifin, Israel

*Corresponding authors:

Maurizio De Pittà

mauriziodepitta@gmail.com

Eshel Ben-Jacob:

eshelbj@gmail.com

Tel.: +972-3-640-7845

Fax: +972-3-642-5787

Abstract

The complexity of the signaling network that underlies astrocyte-synapse interactions may seem discouraging when tackled from a theoretical perspective. Computational modeling is challenged by the fact that many details remain hitherto unknown and conventional approaches to describe synaptic function are unsuitable to explain experimental observations when astrocytic signaling is taken into account. Supported by experimental evidence is the possibility that astrocytes perform genuine information processing by means of their calcium signaling and are players in the physiological setting of the basal tone of synaptic transmission. Here we consider the plausibility of this scenario from a theoretical perspective, focusing on the modulation of synaptic release probability by the astrocyte and its implications on synaptic plasticity. The analysis of the signaling pathways underlying such modulation refines our notion of the tripartite synapse and has profound implications on our understanding of brain function.

Abbreviations:

Adn: adenosine; **AFM:** amplitude and frequency modulation; **AM:** amplitude modulation; **AMPA:** 2-amino-3-(5-methyl-3-oxo-1,2-oxazol-4-yl)propanoic acid; **AMPAR:** AMPA glutamate receptor; **ATP:** adenosine triphosphate; **Ca²⁺:** calcium; **CICR:** Ca²⁺-induced Ca²⁺ release; **D-ser:** D-serine; **EAAT:** excitatory amino-acid transporter; **ER:** endoplasmic reticulum; **FM:** frequency modulation; **GABA:** γ -aminobutyric acid; **GJC:** gap junction channel **Glu:** glutamate; **GluR:** glutamate receptor; **mGluRs:** metabotropic GluR; **GPCR:** G_q protein-coupled receptor; **IP-5P:** inositol polyphosphate 5-phosphatase; **IP₃:** inositol 1,4,5-trisphosphate; **IP₃-3K:** IP₃ 3-kinase; **IP₃R:** IP₃ receptor; **LTD (LTP):** long-term depression (potentiation); **NMDA:** *N*-methyl-D-aspartic acid; **NMDAR:** NMDA glutamate receptor; **PLC δ (PLC β):** phospholipase C δ (C β); **PPR:** paired-pulse ratio; **PR:** purinergic receptor; **PSC:** postsynaptic current; **SIC:** slow inward current; **SNARE:** soluble N-ethylmaleimide-sensitive factor attachment protein; **STDP:** spike-timing – dependent plasticity; **TACE:** TNF α -converting enzyme; **TNF α :** tumor necrosis factor- α .

Introduction

The simultaneous recognition that astrocytes sense neighboring neuronal activity and release neuroactive agents (or “gliotransmitters”) has been instrumental in the uncovering of the many roles played by these cells in the control of genesis, function and plasticity of synapses (Zorec et al., 2012; Santello and Volterra, 2009; Bains and Oliet, 2007; Volterra and Meldolesi, 2005; Ullian et al., 2004; Haydon, 2001). These findings initiated a conceptual revolution that leads to rethinking how brain communication works since they imply that information travels and is processed not just in the neuronal circuitry but in an expanded neuron-glia network (Giaume et al., 2010; Volterra and Meldolesi, 2005; Haydon, 2001). On the other hand the physiological need for astrocyte signaling in brain information processing and the mode(s) of action of these cells in computational tasks remain largely undefined. This is due, to a large extent, both to the lack of conclusive experimental evidence, and to a substantial lack of a theoretical framework to address modeling and characterization of the many possible astrocyte functions. This review aims at introducing such a perspective providing a framework for future modeling efforts in the field based on preliminary theoretical studies on both astrocytic calcium signaling and gliotransmitter-mediated modulations of synaptic release probability.

A theoretical framework for astrocyte-synapse interactions

Control of synaptic transmission and plasticity by astrocytes subtends a complex signaling network, which involves different biochemical pathways (Zorec et al., 2012; Volterra and Meldolesi, 2005). In general, synaptically-released neurotransmitter can spill out of the synaptic cleft and bind to metabotropic receptors found on the neighboring astrocytic processes triggering there inositol 1,4,5-trisphosphate (IP₃)-mediated Ca²⁺ signaling. This was observed at both glutamatergic, cholinergic, noradrenergic and GABAergic synapses in the hippocampus, in the thalamus and in the cortex (Navarrete et al., 2012; Halassa and Haydon, 2010; Santello and Volterra, 2009; Haydon and Carmignoto, 2006; Volterra and Meldolesi, 2005). Figure 1A summarizes a number of observations made at the level of hippocampal glutamatergic synapses (Santello and Volterra, 2009; Bains and Oliet, 2007). There, synaptic glutamate can trigger Ca²⁺ signaling in the surrounding astrocytic processes via metabotropic glutamate

receptors (mGluRs) (Pاناتier et al., 2011; Fiacco and McCarthy, 2004; Pasti et al., 1997). There is also evidence in the dentate gyrus that ATP, possibly synaptically-released, triggers astrocytic Ca^{2+} signaling through the activation of metabotropic purinergic P_2Y_1 receptors (Di Castro et al., 2011; Larsson et al., 2011; Santello et al., 2011; Jourdain et al., 2007). Following elevation of intracellular Ca^{2+} , astrocytes can release glutamate as well as other chemical transmitters such as D-serine (D-ser) and ATP which can be converted into adenosine (Adn) in the extracellular milieu (Henneberger et al., 2010; Parpura and Zorec, 2010; Montana et al., 2006; Pascual et al., 2005; Bezzi et al., 2004). Astrocyte-released glutamate diffuses in the extrasynaptic space and may bind to glutamate receptors (GluRs), including mGluRs and NMDARs on neighboring presynaptic terminals, modulating the release of neurotransmitter (Di Castro et al., 2011; Bonansco et al., 2011; Jourdain et al., 2007; Perea and Araque, 2007; Fiacco and McCarthy, 2004). An analogous action on synaptic release could also be due to astrocyte-derived ATP and its derivative adenosine through presynaptic purinergic receptors (PRs), including both A_1 and A_2 receptors (Pاناتier et al., 2011; Halassa and Haydon, 2010; Pascual et al., 2005). On the postsynaptic side, astrocytic glutamate and D-serine may bind to extrasynaptic NR_2B -containing and postsynaptic NMDARs respectively, modulating neuronal firing and participating in the induction of long-term potentiation (Henneberger et al., 2010; Bains and Oliet, 2007; Fellin et al., 2004). Astrocytes could also release $\text{TNF}\alpha$ by Ca^{2+} -dependent activation of $\text{TNF}\alpha$ -converting enzyme (TACE) (Santello and Volterra, 2012; Bezzi et al., 2001), which could strengthen excitatory synaptic transmission by promoting surface insertion of AMPA receptors (AMPARs) (Bains and Oliet, 2007; Stellwagen and Malenka, 2006; Beattie et al., 2002). This signaling route could also play a role in pathological states such as post-traumatic epilepsy (Volman et al., 2011; Balosso et al., 2009) or spinal chord injury (Ferguson et al., 2008; Stellwagen et al., 2005). On the other hand, extracellular levels of $\text{TNF}\alpha$ control glutamate release from astrocytes ultimately modulating the astrocytic action on presynaptic function (Santello et al., 2011; Domercq et al., 2006). This intricate signaling network is further complicated by the possibility that astrocyte Ca^{2+} events are triggered by additional mechanisms including the action of ATP released extracellularly by the astrocytes themselves or of IP_3 diffusing intracellularly from one astrocyte to another one

through gap junction channels (GJCs) (Scemes and Giaume, 2006; Kang et al., 2005). At Schaffer collateral synapses, astrocytic Ca^{2+} increases could also be promoted by retrograde endocannabinoid signaling from postsynaptic terminals via activation of endocannabinoid CB_1 receptors (Navarrete and Araque, 2010; Navarrete and Araque, 2008) (omitted from Figure 1A for clarity). Moreover, the relation between astrocytic Ca^{2+} and gliotransmitter release is not simple: some of the Ca^{2+} signals that can be generated in astrocytes are apparently not able to induce gliotransmitter release or its synaptic consequences (Lovatt et al., 2012; Agulhon et al., 2010; Agulhon et al., 2008; Petravicz et al., 2008; Fiacco et al., 2007), while gliotransmitters can also be released by mechanisms that are independent of Ca^{2+} signaling (Parpura and Zorec, 2010) (not included in Figure 1A for simplicity).

Despite its apparent complexity, the ensemble of the astrocyte-synapse signaling interactions discussed above can be well captured by the modeling scheme of Figure 1B. This scheme shows the three essential components of the astrocyte-regulated synapses, also referred to as “tripartite synapses” (Haydon, 2001; Araque et al., 1999): these are the pre- (PRE) and postsynaptic (POST) terminals, and the astrocyte, i.e. an astrocytic process surrounding the synaptic elements (ASTRO) (Haydon, 2001; Araque et al., 1999). Moreover, in addition to the classical neuronal path that leads from the input presynaptic action potentials, commonly referred to as input spikes (IN), to the output postsynaptic current (OUT), further input and/or output pathways (I/O) could coexist due to the above-mentioned routes based on astrocytic Ca^{2+} signaling (Giaume et al., 2010). Focusing on the synapse-astrocyte coupling, three fundamental pathways are identified: one (**A**) from the synapse to the astrocyte whereby synaptically-released glutamate (or other synaptic agents) promotes Ca^{2+} signaling in the astrocyte and the other two (**B** and **C**) from the astrocyte to synaptic terminals, whereby glutamate or ATP released from the astrocyte affects synaptic function (Santello and Volterra, 2009; Volterra and Meldolesi, 2005). Additional pathways supported by other neuroactive agents such as D-serine or $\text{TNF}\alpha$ can also be evoked in parallel to those shown in Figure 1B but they would not alter the essence of the scheme. Moreover, although based on experimental results at excitatory synapses in the hippocampus, (Santello et al., 2011; Andersson and

Hanse, 2010; Perea and Araque, 2007; Jourdain et al., 2007; Fiacco and McCarthy, 2004; Araque et al., 1998; Araque et al., 1998), the modeling scheme in Figure 1B could also hold for other reported pathways such as GABA-evoked gliotransmission at interneuron-to-pyramidal cell synapses in the hippocampus (Serrano et al., 2006; Kang et al., 1998), or glia-mediated ATP release at hippocampal synapses (Pascual et al., 2005), in the hypothalamus (Gordon et al., 2009) and in the retina (Newman, 2005; Newman, 2003), or glial modulation of neuromuscular transmission (Rousse et al., 2010; Todd et al., 2010; Robitaille, 1998) (see Table 1 for a summary of the possible signaling pathways).

Analysis of the scheme in Figure 1B reveals that astrocytes mediate two loops in the signal flow from the presynaptic to the postsynaptic terminal: a *feedforward and a feedback one*. The feedforward loop ends on the postsynaptic terminal and is activated when synaptic glutamate and/or ATP induces glutamate and/or D-serine release from the astrocyte to the postsynaptic element, i.e. the **A–C** path in Figure 1B (Santello and Volterra, 2009; Barres, 2008; Bains and Oliet, 2007). The feedback loop ends on the presynaptic terminal (the **A–B** path in Figure 1B) and is activated when synaptic glutamate or ATP trigger Ca^{2+} -dependent release of glutamate and/or ATP from the astrocyte to the presynaptic terminal, leading to modulation of synaptic release through specific presynaptic receptors (Halassa and Haydon, 2010; Santello and Volterra, 2009).

In principle the two pathways could coexist at the same synapse where they are expected to display different dynamics and respond to different preferred input stimuli. Therefore their coexistence at the same synapse could give rise to complex effects that are hard to quantify when considered altogether. Accordingly, a common approach in experiments is to characterize their effects on synaptic function by separate manipulations of pathways **A**, **B**, **C** (Figure 1B) using different techniques (Di Castro et al., 2011; Panatier et al., 2011; Santello et al., 2011; Marchaland et al., 2008; Jourdain et al., 2007; Montana et al., 2004). For example, the characterization of the feedback pathway on the presynaptic terminal (**A–B**) can be carried out by opening the feedback loop (for example by inhibiting elements of **A** or **B**) and analyzing the signaling components separately. From a theoretical point of view, this approach is put forth by at least three steps of analysis that are: (1) characterization of Ca^{2+} dynamics in the astrocyte as a function of

different synaptic inputs (that is, pathway **A**); (2) characterization of how gliotransmitter release from the astrocyte depends on different astrocytic intracellular Ca^{2+} dynamics; and (3) characterization of the effect on synaptic release of Ca^{2+} -dependent gliotransmitter release from the astrocyte (i.e. pathway **B**). These three aspects are discussed below from a modeling perspective, focusing on their possible roles in synaptic information processing.

Characteristics of astrocyte Ca^{2+} excitability and its relationship with synaptic activity

Intracellular Ca^{2+} elevations in the astrocyte are not simple on-off signals (Di Castro et al., 2011; Zonta and Carmignoto, 2002; Carmignoto, 2000). There are multiple and varied spatiotemporal patterns of Ca^{2+} elevation, which probably underlie different types of function, including generation of diverse output signals (Zorec et al., 2012; Volterra and Meldolesi, 2005; Carmignoto, 2000). Two main types of neuronal activity-dependent Ca^{2+} responses are observed in astrocytes (Scemes and Giaume, 2006; Zonta and Carmignoto, 2002; Codazzi et al., 2001; Matyash et al., 2001; Grosche et al., 1999): (1) transient Ca^{2+} increases that are confined to their distal processes (Di Castro et al., 2011; Nett et al., 2002; Pasti et al., 1997) and (2) Ca^{2+} elevations propagating along these processes as regenerative Ca^{2+} waves, often eventually reaching the cell soma (Sul et al., 2004; Pasti et al., 1997). This latter kind of event can even propagate to neighboring astrocytes, giving rise to intercellular Ca^{2+} waves (Kuga et al., 2011; Tian et al., 2005). On the other hand, intercellular Ca^{2+} propagation does not necessarily need propagation through the cell soma and has been observed across astrocytic processes or from an end foot to an end foot (Giaume et al., 2010; Mulligan and MacVicar, 2004).

The precise signaling cascades underlying the various forms of Ca^{2+} elevation are not completely understood. In general, Ca^{2+} signals in astrocytes are determined by an intricate interplay of amplification, buffering, and extrusion pathways linked to cytosolic Ca^{2+} elevations mediated by influx from the extracellular space (Shigetomi et al., 2011; Malarkey et al., 2008) and/or release from the intracellular endoplasmic reticulum (ER) stores (Verkhatsky et al., 2012). IP_3 -triggered Ca^{2+} -induced Ca^{2+} release (CICR) from the ER is considered the primary mechanism responsible for

intracellular Ca^{2+} dynamics in astrocytes (Nimmerjahn, 2009; Volterra and Meldolesi, 2005). This mechanism, schematized in Figure 2A, is essentially controlled by the interplay of three fluxes: (1) a Ca^{2+} transfer from the cytosol to the ER (J_P) mediated by endoplasmic-reticulum Ca^{2+} -ATPase (SERCA) pumps which contributes to the maintenance of higher Ca^{2+} concentrations in the ER stores than in the cytosol; (2) a passive Ca^{2+} leak (J_L) from the ER to the cytosol that is driven by the Ca^{2+} gradient between the ER and the cytosol; and (3) an efflux (J_{NL}) from the ER to the cytosol through IP_3 receptor (IP_3R) channels, which depends both on IP_3 and Ca^{2+} concentrations in the cytosol in a nonlinear fashion (Shinohara et al., 2011; Bezprozvanny et al., 1991).

Cytosolic Ca^{2+} regulates IP_3Rs in a biphasic manner: Ca^{2+} release from the ER is potentiated at low cytosolic Ca^{2+} concentrations but is inhibited at higher Ca^{2+} concentrations (Bezprozvanny et al., 1991; Iino, 1990). On the other hand, IP_3 monotonically activates IP_3R channels at constant Ca^{2+} concentrations (Watras et al., 1991), but dynamically changes the Ca^{2+} sensitivity of the channel (Mak et al., 2003; Kaftan et al., 1997). At low, subsaturating IP_3 concentrations, the optimal Ca^{2+} concentration for IP_3R modulation becomes lower, whereas at very high IP_3 concentrations, channel activity persists at supramicromolar Ca^{2+} concentrations (Mak et al., 2003; Kaftan et al., 1997). Thus, the level of IP_3 determines the dynamics of intracellular Ca^{2+} .

Both production and degradation of IP_3 depend on enzymes that are regulated by cytosolic Ca^{2+} (De Pittà et al., 2009; Berridge et al., 2003). These include Ca^{2+} -dependent PLC δ -mediated IP_3 synthesis and Ca^{2+} -dependent IP_3 degradation by IP_3 3-kinase ($\text{IP}_3\text{-3K}$) and by inositol polyphosphate 5-phosphatase (IP-5P) (Figure 2A) (Rebecchi and Pentylala, 2000; Sims and Allbritton, 1998; Zhang et al., 1993). However, while the activity of $\text{IP}_3\text{-3K}$ is stimulated by cytosolic Ca^{2+} (Communi et al., 1997), IP-5P is inhibited instead (Communi et al., 2001). This results in different mechanisms of IP_3 degradation depending on the Ca^{2+} concentration in the cytoplasm (Irvine et al., 2006; Sims and Allbritton, 1998). Thus, for example, for equally-expressed enzymes, at low Ca^{2+} concentrations, namely lower than 500 nM (De Pittà et al., 2009; Sims and Allbritton, 1998), IP_3 degradation is promoted by both IP-5P and $\text{IP}_3\text{-3K}$, whereas for

intermediate-to-high cytosolic Ca^{2+} concentrations, degradation by IP_3 -3K becomes predominant (Sims and Allbritton, 1998). Theoretical investigation showed that the interplay of these two regimes is both necessary and sufficient to reproduce Ca^{2+} oscillations and pulsations observed experimentally (De Pittà et al., 2009).

Intracellular levels of IP_3 can also be controlled by gap junction mediated diffusion of IP_3 from other regions of the same astrocyte or from neighboring cells (Giaume et al., 2010) (i.e. the I/O pathway in Figure 1B). Moreover, synaptic glutamate (or other synaptic agents) can bind to astrocytic G protein-coupled receptors (GPCRs) like mGluRs that are directly linked to intracellular IP_3 production by $\text{PLC}\beta$ (Zur Nieden and Deitmer, 2006) (pathway A in Figure 1B). In this fashion, astrocytic Ca^{2+} dynamics triggered by synaptically-controlled IP_3 production can be regarded as a form of encoding information about activity in adjacent synapses.

Encoding of synaptic activity by astrocytic Ca^{2+} is likely multimodal, depending on many possible intracellular properties (Dupont et al., 2011; De Pittà et al., 2009; De Pittà et al., 2009; De Pittà et al., 2008). A widely adopted classification considers the amplitude and the frequency of Ca^{2+} increases from basal levels (De Pittà et al., 2009; De Pittà et al., 2008; Falcke, 2004; Berridge, 1997). In this view, as summarized in Figure 2B, synaptic activity reflected by different intracellular IP_3 concentrations (STIMULUS), is encoded by the modulation of Ca^{2+} oscillations and pulsations either in their amplitude (AM), their frequency (FM) or both (AFM). While available experimental data suggest a preferential FM mode of encoding (Pasti et al., 1997), AM and AFM encoding of synaptic activity are also plausible mechanisms given that the amplitude of Ca^{2+} response can strongly depend on the stimulation intensity (Torres et al., 2012; Di Castro et al., 2011; Panatier et al., 2011; Wang et al., 2006). This is the case for example, of synaptic inputs that occur rapidly one after the other whereby the ensuing intracellular Ca^{2+} concentration builds up as a cumulation of such inputs (Torres et al., 2012; Perea and Araque, 2005). In further support of the AM/AFM encoding is the experimental observation that glutamate exocytosis from the astrocyte occurs only when Ca^{2+} increases beyond a threshold concentration (Montana et al., 2006; Auld and Robitaille, 2003; Pasti et al., 2001; Parpura and Haydon, 2000; Newman and Zahs, 1997). Hence,

astrocytic Ca^{2+} increases in response to synaptic activity would not systematically trigger the release of glutamate or other gliotransmitters from the astrocyte. Acting on the amplitude of astrocytic Ca^{2+} signals, AM/AFM encodings could constitute a way to regulate astrocytic gliotransmitter release by synaptic activity. Further experiments are needed to elucidate the nature of the Ca^{2+} threshold for astrocytic exocytosis since this latter might be gliotransmitter-specific (Montana et al., 2006). Accordingly, AM/AFM encoding of Ca^{2+} dynamics could vary from one gliotransmitter to another.

Experimental evidence suggests that Ca^{2+} dynamics does not simply mirror synaptic activity but is more complex, to a point that astrocytes have been proposed to perform genuine processing of synaptic information (Perea et al., 2009; Perea and Araque, 2005). This possibility follows from the complex network of IP_3 and Ca^{2+} signaling and subtends a scenario where Ca^{2+} could be only one of the players in the encoding and processing of synaptic activity by astrocytes (Mishra and Bhalla, 2002). Yet many, if not all, of the other signals underlying the complex cascade of biochemical reactions that link synaptically-released glutamate to CICR, could also carry out encoding and processing (Berridge et al., 2003; Barlow, 1996). Theoretical investigations suggested that IP_3 could also encode for the glutamate stimulation levels via a systematic AFM encoding (De Pittà et al., 2009) as shown in Figure 2C. When cytosolic Ca^{2+} levels are low, close to resting values, IP_3 generally increases with ongoing synaptic activity (Glu). With low Ca^{2+} , the activity of IP_3 -3K is reduced and the resulting IP_3 degradation slows down. The contribution to IP_3 production by Ca^{2+} -dependent $\text{PLC}\delta$ is reduced as well, so that intracellular IP_3 mostly depends on the frequency of synaptic release. Rapid successions of synaptic release events produce crisp increases of IP_3 (essentially proportional to the number of successive synaptic release events) while, between two remote release events, IP_3 tends to relax to resting levels. As a result, IP_3 dynamics overall evolves as the integral of synaptic activity. If IP_3 reaches the CICR-triggering threshold, intracellular Ca^{2+} increases fast and so does IP_3 -3K activity. Then, IP_3 is rapidly degraded and resting IP_3 levels are restored, thus resetting the integral of synaptic activity to initial values.

It is precisely the alternation between these two different phases of IP₃ degradation (a high Ca²⁺–high IP₃-3K-activity phase and a low Ca²⁺–low IP₃-3K-activity phase), that endows IP₃ signal with high amplitude variability. On the other hand, such AM features still allow fast variations, thus rich spectral content (i.e. FM features), in response to changes in frequency of synaptic release. This enticing possibility could endow the IP₃ signal with the necessary properties to function as optimal interface between synaptic stimuli and intracellular Ca²⁺ signals. Since neural information is carried by the timing of spikes rather than by their amplitude (Sejnowski and Paulsen, 2006), the capability of fast highly-variable amplitude changes corresponding to rich spectral content of IP₃ signals, would fulfill this requirement, embedding the essential spectral features of the synaptic signal into the spectrum of the IP₃ transduction. On the other hand, because Ca²⁺ signals are triggered primarily by suprathreshold IP₃ elevations (Keizer et al., 1995; Li et al., 1994), the coexistence of AM features within the AFM IP₃ signal seems to be a necessary prerequisite in order to trigger CICR.

This could also help elucidate the origin of the integrative properties of Ca²⁺ signaling in astrocytes (Perea et al., 2009). These properties could result from at least two steps of integration: one step is the transduction of the agonist signal into the IP₃ signal; the other step is the cross-talk between IP₃ and Ca²⁺ signals. Hence, AFM-encoding IP₃ dynamics could operate a first preliminary integration by smoothing the highly indented synaptic stimulus. The inherent features of CICR would then bring forth a further integration step, yielding Ca²⁺ patterns that are even smoother than IP₃ signals (De Pittà et al., 2009).

The tight dynamical coupling between IP₃ and Ca²⁺ signals also suggests that the way astrocytes process synaptic signals, i.e. their frequency response to synaptic stimuli, is not fixed but rather dynamical and dependent on the history of activation of the astrocyte. This is because different IP₃ signaling mechanisms that are dynamically regulated by Ca²⁺ likely correspond to different frequency responses of the astrocyte with respect to synaptic signals. Figure 2D shows the time course of IP₃ production (IP₃ prod.) and degradation (IP₃ degr.) (*dashed black lines*) underlying simulated IP₃ and Ca²⁺ signals (*top panel, green and black traces* respectively) in response to two events of synaptic glutamate release (*bottom panel*). While Ca²⁺-dependent IP₃ production brought forth

by PLC β (*cyan trace*) and PLC δ (*pink trace*) enzymes could modulate the threshold frequency of synaptic stimuli that triggers Ca $^{2+}$ signaling in the astrocyte, the existence of different regimes of IP $_3$ degradation within a single Ca $^{2+}$ oscillation cycle could be responsible for different cutoff frequencies of synaptic release beyond which Ca $^{2+}$ -mediated astrocyte processing of synaptic stimuli ceases. In particular the cutoff frequency during low IP $_3$ -3K activity could be mainly set by the rate of IP $_3$ degradation by IP-5P (*orange trace*). When Ca $^{2+}$ is high instead, IP $_3$ degradation by IP $_3$ -3K (*purple trace*) could also become very strong, thus sensibly reducing the cutoff frequency. That is, the cutoff frequency is dependent on the context of underlying Ca $^{2+}$ signaling which in turn depends on the history of activation of the astrocyte by synaptic stimuli.

The subcellular arrangement of the enzymes underlying IP $_3$ signaling could also be responsible for spatial heterogeneity of the frequency response of the astrocyte. Although the subcellular localization of IP $_3$ production and degradation enzymes in astrocytes remains to be elucidated, studies in brain tissue suggest that PLC β and IP-5P could localize mainly in proximity to the plasma membrane, whereas PLC δ and IP $_3$ -3K are preferentially in the cytoplasm (Irvine et al., 2006; Rebecchi and Pentylala, 2000). Given that the ER distribution changes from astrocytic processes to soma (Pivneva et al., 2008), different subcellular regions of the astrocyte could correspond to different cytoplasmic volumes and thus to distinctly different expressions of enzymes mediating IP $_3$ signaling. The ensuing different subcellular arrangement of these enzymes could ultimately provide anatomical specificity to the astrocytic phosphoinositide signaling which underlies CICR-based astrocyte processing of synaptic activity (Fukaya et al., 2008). In this fashion, processing of synaptic stimuli by Ca $^{2+}$ signaling at astrocytic processes could differ from that carried out in the soma by means of differently expressed IP $_3$ signaling-related enzymes.

Computational aspects of propagating Ca $^{2+}$ signals

Intracellular and intercellular propagation of Ca $^{2+}$ could contribute new encoding and processing modes, in addition to those depicted in Figure 2B. However, despite the numerous modeling studies developed to account for the rich dynamics of astrocyte Ca $^{2+}$

signaling (Dupont et al., 2011; Goldberg et al., 2010; Bennett et al., 2008); for a recent review on calcium modeling see (Falcke, 2004), we still lack a comprehensive theoretical framework to link the local Ca^{2+} signals that are restricted to small regions of the astrocytic processes, to their spatial dynamics and their possible propagation at larger spatial scales: intracellular propagation, global whole-cell signals or cell-to-cell Ca^{2+} waves.

Propagations at these various scales probably differ by their underlying mechanisms (Scemes and Giaume, 2006; Falcke, 2004). Fast-rising and short-lived local Ca^{2+} events, observed in response to even a single quantal release from synaptic terminals (Di Castro et al., 2011; Panatier et al., 2011) closely resemble spatially confined Ca^{2+} puffs or blips in other cell types (Bootman et al., 2001; Thomas et al., 2000) and could depend on spatial clustering of IP_3 Rs along the ER structures or of mGluRs along the plasma membrane, or on both (Arizono et al., 2012; Panatier et al., 2011; Marchaland et al., 2008). The cumulative recruitment of these Ca^{2+} puffs could lead to spatially more extended Ca^{2+} events which could either be still confined within astrocytic processes (Di Castro et al., 2011) or propagate to other cellular regions or to other cells as regenerative Ca^{2+} waves (Kuga et al., 2011; Pasti et al., 1997).

Calcium could propagate by at least two routes (for a recent review see (Scemes and Giaume, 2006). One is intracellular, through gap junction channels, involving diffusion of IP_3 directly from cytoplasm to cytoplasm. The other route is extracellular, involving release of ATP from the astrocyte which binds to GPCRs of the same cell or neighboring astrocytes, increasing their IP_3 levels (Guthrie et al., 1999). The relative contribution of each of these pathways likely depends on developmental, regional and physiological states and could subtend different ranges of propagations as well as different temporal features (Giaume et al., 2010; Haas et al., 2006; Scemes and Giaume, 2006).

The restriction and clustering of mGluRs expression along astrocytic processes to subregions that colocalize with synaptic terminals (Arizono et al., 2012; van den Pol et al., 1995) hints the possibility of a subcellular compartmentalization of Ca^{2+} signals (Di Castro et al., 2011; Panatier et al., 2011; Marchaland et al., 2008). Local Ca^{2+} events would be spatially restricted to narrow regions around each mGluRs cluster thus defining independent signals within the same process. In this fashion, astrocytes could carry out

parallel integration and processing of synaptic information on different temporal and spatial scales at different processes (Bernardinelli et al., 2011; Goldberg et al., 2010) or even in different subregions of the same process which could constitute separate functional microdomains (Panatier et al., 2011). Furthermore, the resulting neuromodulatory action exerted by astrocytic gliotransmitters on synaptic terminals and their impact on neuronal network activity could vary from one process or microdomain to the other (Navarrete and Araque, 2011).

The spatial scale and the time window of Ca^{2+} events likely discriminate between different mechanisms of IP_3 and Ca^{2+} signaling. At the level of astrocytic processes and subcellular compartments, Ca^{2+} propagation could be mediated by fast intracellular IP_3 linear (i.e. Fickian) diffusion (Falcke, 2004; Sneyd et al., 1994). On the other hand, when considering intercellular propagation mediated by gap junctions, IP_3 transport from one cell to the other could be essentially nonlinear. This scenario was shown to be consistent with the observed variability of Ca^{2+} wave propagation distance (Goldberg et al., 2010) and could explain the long-range regenerative propagation of Ca^{2+} waves observed in cortical astrocytes (Scemes and Giaume, 2006; Tian et al., 2006).

Cell heterogeneity likely constitutes an additional critical aspect that substantially affects the propagation patterns and the extent of propagation of Ca^{2+} signals (Iacobas et al., 2006; Goldberg et al., 2010; De Pittà et al., 2008). This possibility is illustrated in Figure 2E by a toy example consisting of a heterogeneous linear chain of FM-encoding (*red traces*) and AFM-encoding (*green traces*) astrocytes. The synaptic stimulus is restricted to the first cell of the chain (i.e. cell number 1). Only FM-encoding cells guarantee regenerative propagation of Ca^{2+} signals, whereas AFM cells do not, acting like propagation barriers along the chain. Unlike in AFM cells, Ca^{2+} -dependent IP_3 production in FM cells guarantees IP_3 diffusion to the next cell in the chain to levels that are beyond the threshold of CICR thus promoting regenerative propagation (Goldberg et al., 2010). Moreover, the shape of the local Ca^{2+} events in each cell changes along the propagation path: after each AFM cell, the frequency of FM-encoding Ca^{2+} pulses is reduced, suggesting that different propagation patterns could carry out different processing of synaptic information (Goldberg et al., 2010).

The above scenario hints that the spatial distribution of astrocytes in different brain areas could be made to fulfill specific processing tasks. Indeed neighboring astrocytes in the brain are believed to be distributed in space in a nonrandom orderly fashion called “contact spacing” (Volterra and Meldolesi, 2005; Chan-Ling and Stone, 1991) or “tiling”, where each astrocyte creates its micro-anatomical domain with its processes overlapping with adjacent astrocytes only at their periphery (Bushong et al., 2002). Such spatial arrangement, combined with the heterogeneity of astrocytic responses could be important in intercellular Ca^{2+} wave propagations and the related computational tasks carried out by astrocyte networks. The latter could be relevant in particular, for the emergence of astrocytic functional maps observed in several brain areas (Giaume et al., 2010).

Increasing evidence argues in fact for a functional organization of astrocytes, reminiscent of that of cortical neurons (Bernardinelli et al., 2011). In the ferret visual cortex astrocytes, like neurons, respond to visual stimuli, with distinct spatial receptive fields and sharp tuning to visual stimulus features, including orientation and spatial frequency (Schummers et al., 2008). The stimulus-feature preferences of astrocytes there can be mapped across the cortical surface, in close register with neuronal maps (Schummers et al., 2008). Similar observations were also reported for astrocytes in the motor cortex (Haas et al., 2006) and in the somatosensory cortex (Schipke et al., 2008) as well as in the olfactory bulb (De Saint Jan and Westbrook, 2005).

Anatomical compartmentalization of astrocyte networks could underlie such functional organization. Both in the somatosensory barrel cortex and in the olfactory bulb, astrocytes are preferentially connected by gap junctions within the same barrel or olfactory glomerulus rather than between adjacent barrels or glomeruli (Roux et al., 2011; Houades et al., 2008). However spatial confinement of gap junctions within single barrels/glomeruli might not fully account for the selective activation of astrocyte by electrical stimulation. Indeed, similar Ca^{2+} signals in response to the same stimulus could be observed in the same barrel yet with pharmacological block of astrocyte gap junctions (Schipke et al., 2008). Thus, additional factors must contribute to the astrocyte tuned response, which likely emerges as a result of the dynamical interactions with surrounding neurons (Rouach et al., 2004) and could ultimately depend on location and nature of activated cells among the other astrocytes in the network (García-Marqués and López-

Mascaraque, 2012; Matyash and Kettenmann, 2010). In the case of Figure 2E, for example, stimulated FM-encoding cells could trigger Ca^{2+} signaling in neighboring cells in a regenerative fashion thus extending their tuned response in space. On the other hand, AFM cells, acting as propagation barriers, could shape the borders of this tuned response, eventually drawing the topographical features of the ensuing functional map (Lallouette and Berry, 2012).

Relating Ca^{2+} signals to gliotransmitter exocytosis from the astrocyte

There is a number of possible routes by which astrocytes could release gliotransmitters (Zorec et al., 2012; Parpura and Zorec, 2010; Ni et al., 2007), but Ca^{2+} -dependent exocytosis is likely the major one on a physiological basis (Parpura et al., 2011; Barres, 2008). However, the identity of the incoming inputs, the underlying molecular mechanism and the physiological conditions that govern gliotransmitter exocytosis largely remain to be elucidated (Parpura and Zorec, 2010; Santello and Volterra, 2009; Ni et al., 2007; Montana et al., 2006). Calcium-dependent exocytosis of glutamate or ATP from astrocytes, for example, may strictly depend on the nature of the upstream Ca^{2+} signal (Malarkey and Parpura, 2011; Li et al., 2008; Marchaland et al., 2008; Pryazhnikov and Khiroug, 2008; Perea and Araque, 2005); including the type of neurotransmitter involved and the type of receptor engaged (Blomstrand and Giaume, 2006; Bezzi et al., 2004; Coco et al., 2003; Muyderman et al., 2001; Enkvist and McCarthy, 1992). The influence of astrocytic glutamate or ATP on synaptic activity also likely depends both on the type of incoming stimulus and on the specific localization of the engaged receptor in the astrocyte (Santello and Volterra, 2009; Perea and Araque, 2005).

A large amount of evidence suggests that gliotransmitter exocytosis from astrocytes bears several similarities with its synaptic homologous (Bergersen et al., 2011; Bergersen and Gundersen, 2009; Santello and Volterra, 2009) (Figure 3A). Astrocytes possess vesicular compartments that are competent for the regulated exocytosis of glutamate (Bergersen and Gundersen, 2009; Bezzi et al., 2004) and ATP (Jaiswal et al., 2007; Zhang et al., 2007; Coco et al., 2003). Similarly to synapses, astrocytes express SNARE proteins necessary for exocytosis (Schubert et al., 2011; Parpura et al., 1995) as well as proteins

responsible for concentrating glutamate or ATP into vesicles (Sawada et al., 2008; Bezzi et al., 2004; Montana et al., 2004; Zhang et al., 2004). Fusion with the plasma membrane, trafficking and recycling of astrocytic glutamate and ATP secretory vesicles have been observed (Jaiswal et al., 2007; Pangršic et al., 2007; Stenovec et al., 2007; Chen et al., 2005; Crippa et al., 2006; Bezzi et al., 2004), which are indicative of quantal glutamate and ATP release (Del Castillo and Katz, 1954; Santello et al., 2011; Marchaland et al., 2008; Jaiswal et al., 2007; Pangršic et al., 2007; Domercq et al., 2006; Pasti et al., 2001). Glutamate exocytosis from cultured astrocytes evoked by GPCRs is observed with short delay, i.e. 50 – 100 ms, after the rise in submembrane Ca^{2+} , and is mediated by a rapid succession of fusion events which peaks within ~500 ms from the onset and decays to baseline much more slowly (>1 s), though generally before the recovery of basal Ca^{2+} levels (Santello et al., 2011; Marchaland et al., 2008; Domercq et al., 2006) (refer also to Table 2). In addition to this “exocytotic burst”, larger delays with slower rate of sustained vesicular fusion events have also been reported (Malarkey and Parpura, 2011; Kreft et al., 2004). The delayed onset with respect to the Ca^{2+} rise is consistent with a threshold Ca^{2+} concentration for release (Pasti et al., 1997; Parpura and Haydon, 2000). On the other hand the overall release of glutamate is characterized by a rising phase much faster than its decay and can be approximated by an exponential function like synaptic exocytosis yet with a decay time much slower than the latter (De Pittà et al., 2011; Santello et al., 2011; Marchaland et al., 2008) (Figure 3B). Although much less characterized than its glutamate counterpart, astrocytic ATP exocytosis could occur in a qualitatively similar fashion in spite of different underlying kinetics (Li et al., 2008; Pryazhnikov and Khiroug, 2008; Pangršic et al., 2007). Based on these arguments, it was proposed that astrocytic gliotransmitter release could be modeled using the same mathematical description of synaptic release, although the two mechanisms are likely different in their molecular machinery, with the kinetics of astrocyte release much slower than synaptic release (De Pittà et al., 2011; Schubert et al., 2011).

How are different modes of Ca^{2+} encoding translated into glutamate or ATP release? Assuming proper conditions about the rate of clearance of these gliotransmitters with respect to the underlying intracellular Ca^{2+} dynamics that mediate their exocytosis (Abbracchio et al., 2009), an intriguing theoretical prediction is that various patterns

of Ca^{2+} oscillations could mostly correspond to different rates of gliotransmitter release (De Pittà et al., 2011). This is presented in Figure 3C where, for three stereotypical patterns of Ca^{2+} oscillations, that is AM, FM and AFM, the corresponding timing of gliotransmitter release from the astrocyte is shown. In this example, FM-encoding Ca^{2+} oscillations always cross the threshold for exocytosis (*dashed red line*), triggering gliotransmitter release every time. Conversely, AM or AFM oscillations may not be large enough to reach such a threshold, resulting in some oscillations that fail to trigger gliotransmitter release. In this fashion, while the FM Ca^{2+} oscillations trigger gliotransmitter exocytosis at their own frequency, the amplitude of AM and AFM oscillations could selectively discriminate which Ca^{2+} pulse triggers exocytosis, eventually dictating the frequency of “measured” glutamate or ATP release events (De Pittà et al., 2011). Further experimental investigations are required to elucidate whether such prediction could effectively mimic reality.

While astrocytic Ca^{2+} signals could be triggered both by spontaneous and evoked synaptic release, gliotransmitter release might be not (Di Castro et al., 2011; Panatier et al., 2011). Blockade of Ca^{2+} -dependent glutamate release in astrocytes in the dentate gyrus was indeed observed to be effective in reducing the frequency of synaptic release events only when these were evoked by action potentials, but not when they happened spontaneously. This suggests that release of glutamate from astrocytes in this region could effectively occur only in presence of evoked synaptic activity (Di Castro et al., 2011). Interestingly, the Ca^{2+} elevations in astrocyte processes triggered by action potentials were reported to be more complex, larger in amplitude and more extended in space, than those generated by spontaneous synaptic release events. Since glutamate could be released from several sites along the same astrocyte process and this latter could contact several synapses (Panatier et al., 2011), one of such Ca^{2+} elevations could then generate multiple spatially-distinct glutamate release events modulating synaptic release at several other synapses. The same Ca^{2+} elevation however, could bring forth at subcellular regions of the process, different local Ca^{2+} dynamics, in close analogy to the behavior of the heterogeneous AM/AFM oscillations in the astrocyte chain in Figure 2E. Such different local Ca^{2+} dynamics could in turn result in different rates of glutamate release and thus in different modulations of synaptic release in a nonrandom fashion. In

this way, the same astrocytic process or a segment of it, could carry out multiple regional modulations of synaptic release, depending both on the temporal and spatial dynamics of synaptic release. It is however possible that the mechanisms underlying Ca^{2+} -dependent gliotransmission differ in different brain areas (Matyash and Kettenmann, 2010; Zhang and Barres, 2010). Indeed, in contrast with the above observations in the dentate gyrus, astrocytes in the stratum radiatum of the hippocampus were reported to release glutamate even in the absence of synaptic activity evoked by action potentials (Bonansco et al., 2011).

Another issue is what makes a single astrocyte release one gliotransmitter rather than another. A possibility is that different gliotransmitters are released in response to different stimuli. *In situ* studies indeed suggest that purinergic GPCR-mediated astrocytic Ca^{2+} signals could preferentially trigger glutamate release (Di Castro et al., 2011; Jourdain et al., 2007; Perea and Araque, 2007) (see also Table 1). In contrast, Ca^{2+} elevations triggered by glutamate could bring forth ATP release (Panatier et al., 2011; Gordon et al., 2009; Pascual et al., 2005). Overall these observations hint that a tight association likely exists between the type of targeted astrocytic receptor and the secretory machinery of gliotransmitters (Zorec et al., 2012). Moreover, in the same astrocyte, different gliotransmitters could be contained in different organelles with different secretory properties in response to Ca^{2+} signals (Coco et al., 2003). Indeed while glutamate seems to be preferentially released by synaptic-like microvesicles (Bergersen et al., 2011; Jourdain et al., 2007; Bezzi et al., 2004), ATP is likely released by dense-core granules (Coco et al., 2003) and/or lysosomes (Li et al., 2008; Jaiswal et al., 2007; Zhang et al., 2007). Although the underlying molecular machinery of exocytosis remains to be elucidated, each organelle population is likely secreted in a different fashion (Pryazhnikov and Khiroug, 2008). *In vitro* evidence showed in fact that Ca^{2+} signals that triggered release of glutamate-containing vesicles (Marchaland et al., 2008) did not release ATP-filled organelles and viceversa (Li et al., 2008; Coco et al., 2003), ultimately suggesting that glutamate and ATP could be released in response to different Ca^{2+} signals (Papura and Zorec, 2010).

Intriguingly, stimulation of astrocyte GPCRs can evoke fast gliotransmitter exocytosis within few hundreds of milliseconds (Santello et al., 2011; Marchaland et al., 2008;

Domercq et al., 2006; Bezzi et al., 2004), indicating that the Ca^{2+} -dependent process that couples stimulus with secretion must be fast. Indeed, the peak of GPCR-mediated Ca^{2+} release from the ER can be as fast as 50-250 ms ((Di Castro et al., 2011; Panatier et al., 2011; Marchaland et al., 2008) and Ca^{2+} -dependent exocytosis of single glutamate vesicles can occur within less than 5 – 20 ms from Ca^{2+} elevation (Santello et al., 2011; Marchaland et al., 2008; Bowser and Khakh, 2007; Chen et al., 2005). Therefore, to assure fast stimulus-secretion coupling, IP_3 diffusion from the site of production by GPCRs at the plasma membrane to IP_3 receptors on the ER membrane must also be of the order of tens of milliseconds and so must Ca^{2+} diffusion from the mouth of IP_3 Rs to the Ca^{2+} sensor of exocytosis (Ni et al., 2007; Zhang et al., 2003). Given that the diffusion times of IP_3 or Ca^{2+} can be estimated as the half of the square of the diffusion distance from the site of their production in the cytoplasm divided by the respective diffusion constants (Syková and Nicholson, 2008), which can be as high as $\sim 200 - 300 \mu\text{m}^2/\text{s}$ for IP_3 (Sneyd et al., 1994; Allbritton et al., 1992) and $30 \mu\text{m}^2/\text{s}$ for Ca^{2+} (Kang and Othmer, 2009), then diffusion times of the order of milliseconds could be obtained only for diffusion lengths at most in the micron range. This prediction is fully supported by the functional evidence of local GPCR-evoked, ER-dependent Ca^{2+} microdomains in astrocytic processes (Di Castro et al., 2011; Panatier et al., 2011) and by the morphological evidence that at astrocytic processes the ER stores are found at $\sim 200 - 600 \text{ nm}$ distance both from the plasma membrane and gliotransmitter-containing vesicles (Bergersen et al., 2011; Marchaland et al., 2008; Bezzi et al., 2004). Moreover, GPCR agonist-mediated Ca^{2+} transients were observed in restricted subplasma areas in close proximity to the sites of exocytosis (Marchaland et al., 2008), suggesting that both GPCRs and secretory vesicles must be spatially close to the IP_3 Rs responsible for Ca^{2+} release from the ER. This indicates that the location of IP_3 Rs along the ER membrane in astrocyte processes might be nonrandom (Blaustein and Golovina, 2001), in tight spatial association with astrocytic GPCRs on the plasma membrane and releasable gliotransmitter organelles (Panatier et al., 2011; Marchaland et al., 2008). Such spatial coupling could ultimately underlie the preferential occurrence of functional gliotransmission from astrocytic processes rather than from the soma (Gordon et al.,

2009), entailing strict spatiotemporal requirements for Ca^{2+} signals to trigger release of gliotransmitters from the astrocyte and modulate synaptic transmission.

Modulation of synaptic release by astrocytic glutamate and ATP

Astrocyte-derived glutamate and ATP or adenosine can modulate synaptic transmission, either increasing neurotransmitter release (Bonansco et al., 2011; Di Castro et al., 2011; Panatier et al., 2011; Jourdain et al., 2007; Perea and Araque, 2007; Fiacco and McCarthy, 2004; Araque et al., 1998) or decreasing it (Andersson and Hanse, 2011; Andersson and Hanse, 2010; Pascual et al., 2005; Zhang et al., 2003) depending on the type of presynaptic receptor involved and the brain area (pathway **B** in Figure 1B; see also Table 1). At excitatory synapses in the hippocampal dentate gyrus, glutamate is released from surrounding astrocytic processes in close proximity to presynaptic NR_2B -containing NMDA receptors (Figure 4A). Activation of these receptors results in increased synaptic release and strengthening of synaptic transmission (Jourdain et al., 2007). At Schaffer collateral synapses in the CA1 hippocampal area a similar effect is mediated by presynaptic mGluRs (Perea and Araque, 2007; Fiacco and McCarthy, 2004). Besides directly targeting presynaptic receptors, astrocyte-released glutamate could also bind ionotropic receptors found along the axons of hippocampal CA3 pyramidal cells, broadening the profile of propagating action potentials (APs) (Sasaki et al., 2011). The broadened APs in turn, trigger larger Ca^{2+} elevations in presynaptic boutons, resulting in larger synaptic release probability.

Conversely, astrocyte-released ATP and its derivative adenosine, bind to presynaptic purinergic receptors, i.e. $\text{P}_2\text{Y}_1\text{Rs}$ or A_1Rs respectively, decreasing synaptic release (Pascual et al., 2005; Zhang et al., 2003). However, astrocyte-derived adenosine, could also target $\text{A}_{2\text{A}}$ receptors which can increase synaptic release (Panatier et al., 2011) (omitted from Figures 1A and 4A for simplicity). Both effects of adenosine – inhibitory via A_1Rs and stimulatory via $\text{A}_{2\text{A}}\text{Rs}$ – have been described at hippocampal CA3-CA1 synapses (Panatier et al., 2011; Serrano et al., 2006; Pascual et al., 2005; Zhang et al., 2003), and the prevalence of one on the other likely depends on the level of synaptic activity (Panatier et al., 2011). This would be in line with observations at the frog's neuromuscular junction, where different stimulations of the tibial nerve differentially activated A_1Rs or $\text{A}_{2\text{A}}\text{Rs}$ in association with different Ca^{2+} dynamics in the peri-

junctional glial cell (Todd et al., 2010). Intriguingly, at hippocampal synapses different synaptic stimuli could differentially change the morphology of astrocyte perisynaptic processes (Lavialle et al., 2011; Haber et al., 2006) thus reshaping, in an activity-dependent fashion, the extracellular space of interaction between astrocyte-derived adenosine and presynaptic receptors. This could dynamically regulate access of adenosine to one receptor with respect to the other (Syková and Nicholson, 2008; Haber et al., 2006) ultimately modulating synaptic release in a complex fashion. The functional consequences of astrocytic remodeling was indeed demonstrated in the supraoptic nucleus, where dynamic changes in the astrocytic wrapping of synapses during lactation could regulate the extent of synaptic glutamate spillover and thereby control heterosynaptic depression of GABAergic transmission by presynaptic mGluRs (Piet et al., 2004; Oliet et al., 2001).

The opposite effects due to astrocytic glutamate or ATP/adenosine could endow astrocytes with the capacity to exert non-stereotyped bimodal control of synaptic transmission (Volterra and Meldolesi, 2005). On the other hand, the temporal concurrence of both these effects due to co-expression of inhibitory and stimulatory receptors at the same synaptic terminals (Rebola et al., 2005; Shigemoto et al., 1997), could result in occlusion, i.e. no net effect on synaptic release by the astrocyte (De Pittà et al., 2011). Alternatively, balanced activation (and possibly occlusion) of A_1 and A_{2A} receptors by astrocyte-derived adenosine could set synaptic release in basal conditions (Panatier et al., 2011). Hence, the ensuing regulation of synaptic transmission triggered by gliotransmitters in response to stimuli, could result instead from an unbalance of activation of these receptors rather than by the distinct activation of one receptor type with respect to the other, ultimately providing a high degree of complexity in the control of synaptic transmission by astrocytes. For the sake of clarity, in the following we will consider only release-decreasing effects of astrocyte ATP or its derivative, adenosine.

The details of the biochemical mechanism underlying modulation of synaptic release by astrocytic glutamate or ATP (or adenosine) likely depend on the type of targeted presynaptic receptors and are not fully understood (Pinheiro and Mulle, 2008). The simplest explanation would be that astrocytic glutamate and ATP lead to a modulation of presynaptic intracellular Ca^{2+} levels which eventually results in a modulation of synaptic

release probability (Pinheiro and Mulle, 2008; Zucker and Regehr, 2002) with significant repercussions on synaptic plasticity, including short-term depression and facilitation.

Short-term facilitation and depression can be assessed by measuring the paired-pulse ratio (PPR), i.e. the ratio between the amplitudes of successive postsynaptic currents (PSCs) recorded in response to a pair of action potentials in rapid succession as illustrated in Figure 4B (Zucker and Regehr, 2002). When the value of the peak postsynaptic current associated to the second incoming spike is larger than the peak current recorded in coincidence with the first spike (*green traces*), then synaptic release is increasing for incoming spikes, i.e. facilitation occurs, and the corresponding PPR is larger than unity. Conversely, when the second peak is less than the first peak (*magenta traces*), this marks a decrease of neurotransmitter release from the presynaptic terminal which reflects depression, and the corresponding value of PPR is less than one. It should be noted that by varying the interval between two pulses the same synapse can be either depressed or facilitated. For simplicity we omit the interpulse interval as a variable in this description.

In general, in basal conditions, i.e. in response to an individual action potential, the value of synaptic release probability of an individual synapse or of an ensemble of synapses defines the nature of synaptic transmission at that synapse/ensemble, namely whether it is facilitating or depressing, with low values of probability favoring facilitation and high values favoring depression (Abbott and Regehr, 2004) (Figure 4B, *right*). Thus, any modulation of synaptic release probability by gliotransmitters that changes the PPR from below unity to values above it or vice versa, could switch the mode of synaptic transmission from depressing to facilitating or vice versa. This scenario was theoretically addressed in (De Pittà et al., 2011) and it was shown to substantially agree with experiments. Indeed, at hippocampal synapses, the increase of synaptic release probability due to astrocytic glutamate correlates with a *decrease* of the PPR (Bonansco et al., 2011; Jourdain et al., 2007; Perea and Araque, 2007). Conversely, a decrease of synaptic release due to the action of astrocyte-derived ATP (or adenosine) is accompanied by an *increase* of the PPR (Zhang et al., 2003). The frequency of astrocytic glutamate (Glu) and/or ATP exocytosis are likely crucial in the regulation of the extent of the modulation of synaptic release by astrocytes (De Pittà et al., 2011), a principle

illustrated in Figure 4C. This figure shows the simulated peak postsynaptic currents for the same synapse in response to 100 trials of presynaptic spike trains with identical statistics (*raster plots*). Each column in Figure 4C corresponds to a different frequency of astrocytic Ca^{2+} pulses (*top row*), yielding to different frequencies of gliotransmitter release when Ca^{2+} crosses the threshold for exocytosis (*dashed red line*) (see also Figure 3B). Colors in the raster plots refer to paired-pulse plasticity quantified by PPR. For two consecutive presynaptic spikes, if the second spike releases synaptic neurotransmitter more than the first spike, then it is $\text{PPR} > 1$, paired-pulse facilitation is observed, and the peak postsynaptic current associated to the second spike is colored in *green*. Vice versa, if the amount of neurotransmitter released by the second spike is less than that released by the first one, then $\text{PPR} < 1$, that is paired-pulse depression occurs, and the second peak postsynaptic current is colored in *magenta*.

In absence of astrocytic gliotransmitter (*left column*), the raster plot of a facilitating synapse (*middle row*) shows predominant paired-pulse facilitation, i.e. mostly *green* dots. However, in presence of release of glutamate from the astrocyte (+Glu), as explained above, the stimulatory effect of this gliotransmitter on synaptic release changes paired-pulse plasticity which is marked by the appearance of *magenta* bands in the raster plots (*middle and right columns*). These bands locate time intervals where paired-pulse depression becomes prominent (i.e. predominance of *magenta* dots) on the overall paired-pulse facilitation background (*green dots*). Notably these bands are almost in coincidence with glutamate release from the astrocyte (*top row*) and their number increases with the glutamate release frequency. Therefore, for the same time window, the same originally-facilitating synapse gets increasingly depressing as the rate of glutamate release from the astrocyte increases. The opposite is observed for an otherwise depressing synapse (i.e. predominance of paired-pulse depression, thus mostly *magenta* dots in the *bottom left* raster plot). In this case, in presence of release of ATP and its derivative adenosine (+ATP/Adn) from the astrocyte, due to the inhibitory effect of astrocyte-derived purines on synaptic release considered in this example, *green* bands appear in the raster plots which mark the onset of periods of predominant paired-pulse facilitation. The number of these bands grows for higher rates of ATP release from the astrocyte so that

the same originally-depressing synapse behaves more akin of a facilitating one as the rate of ATP release from the astrocyte increases.

An intriguing prediction that follows from the above arguments is that the frequency of gliotransmitter release, by modulating synaptic release probability at basal conditions, could dynamically control the nature of synaptic transmission as elucidated in Figure 5A. In particular, under certain conditions, a threshold frequency for gliotransmitter release (*blue line*) could exist above which the astrocyte can switch the nature of synaptic transmission, turning depressing synapses into facilitating or vice versa, facilitating synapses into depressing (De Pittà et al., 2011). Hence, the plasticity mode at such synapses is not fixed but rather it is set by the release rate of gliotransmitters from neighboring astrocytic processes.

Remarkably, the threshold frequency of gliotransmitter release that discriminates between facilitation and depression at one synapse can be as low as 0.05 Hz or less (as in the case of Figure 5A) thus falling within the range of Ca^{2+} oscillations observed in astrocytes in basal conditions (Bonansco et al., 2011; Di Castro et al., 2011; Parri et al., 2001; Aguado et al., 2002). In such conditions as shown in Figure 5B (*top*), intracellular Ca^{2+} levels in astrocytes spontaneously fluctuate in a highly stochastic fashion (Di Castro et al., 2011; Hirase et al., 2004) and can similarly cross the threshold for gliotransmitter release. The ensuing release of gliotransmitter, however, could be sufficient to tonically set the basal tone of synaptic transmission (Figure 5B). Inasmuch as the rate of gliotransmitter release could also correlate with the incoming synaptic stimulus through Ca^{2+} dynamics in the astrocytes (Di Castro et al., 2011; Aguado et al., 2002), this scenario discloses the possibility that astrocytes act as endogenous regulators of the efficacy of synaptic transmission (Di Castro et al., 2011; Panatier et al., 2011; Giaume et al., 2010; Halassa and Haydon, 2010; Haydon, 2001). That is, through integration of synaptic activity by means of their Ca^{2+} signals, astrocytes could adapt synaptic strength according to the history of the synapse.

Implications of astrocyte modulation of synaptic transmission and plasticity

The effect of modulation of synaptic release probability by astrocytic gliotransmitters may decay more slowly than the Ca^{2+} elevation triggering astrocyte exocytosis (Serrano et al., 2006; Fiacco and McCarthy, 2004), and still be present upon gliotransmitter release by following Ca^{2+} increases (Volman et al., 2007). Therefore astrocytic Ca^{2+} activity resulting in high rates of gliotransmitter release, could bring forth long-lasting modulations of synaptic release. Insofar as synaptically-released neurotransmitter could shape postsynaptic signaling at the basis of long-term synaptic plasticity (Bliss and Collingridge, 1993), persistent modulations of synaptic release probability by astrocyte could ultimately contribute to long-term changes of synaptic strength underlying neural processing, memory formation and storage of information. Support to this scenario comes from studies on hippocampal synapses for which the temporal coincidence of postsynaptic depolarization with the increase of Ca^{2+} elevations in neighboring astrocytes was shown to induce long-term potentiation (LTP) of synaptic transmission (Navarrete et al., 2012; Navarrete and Araque, 2010; Perea and Araque, 2007). Notably, this form of LTP is independent of the activation of postsynaptic NMDARs but rather, it depends on glutamate released from astrocytes, which persistently potentiates synaptic transmitter release through activation of presynaptic mGluRs (Perea and Araque, 2007). On the other hand, at synapses between excitatory neurons in layers 4 and 2/3 in the rat barrel cortex, activity-dependent induction of long-term depression (LTD) also requires astrocyte Ca^{2+} signaling (Min and Nevian, 2012). At these synapses, postsynaptically-released endocannabinoids mediate Ca^{2+} -dependent release of glutamate from astrocytes which targets presynaptic NMDARs bringing forth LTD (Rodríguez-Moreno and Paulsen, 2008; Sjöström et al., 2003).

The differential induction of LTP and LTD in neighboring synapses has been suggested to determine the size and shape of cortical functional topographic units such as ocular dominance columns in the primary visual cortex and whisker barrels in the primary somatosensory cortex (Li et al., 2009; Feldman and Brecht, 2005; Hensch, 2005). Thus, the possible involvement of astrocytes in LTP and LTD suggests that these cells could

contribute to the plasticity of cortical maps and the development of corresponding sensory representations (Rossi, 2012).

Modulation of synaptic release probability by astrocytic gliotransmitters could also alter the temporal order of correlated pre- and postsynaptic spiking that critically dictates spike-timing-dependent plasticity (STDP) (Pascual et al., 2005). Inhibition of spontaneous glutamate release from astrocytes in hippocampal CA1 synapses, consistent with a decrease of synaptic release probability, was indeed reported to modify the threshold for induction of spike-timing-dependent LTP (Bonansco et al., 2011). In this fashion, astrocytes by gliotransmission-mediated regulations of synaptic release probability could control not only different mechanisms of synaptic plasticity but also the threshold of synaptic activity required for their onset, thus playing a role in metaplasticity too, that is the plasticity of synaptic plasticity (Abraham, 2008).

Gliotransmitters do not control synaptic plasticity only via presynaptic actions, but also by actions on postsynaptic receptors. Indeed, the induction of LTP itself appears to be uniquely controlled by astrocytes through the release of D-serine (Santello and Volterra, 2010) (pathway C in Figure 1B). Both at hippocampal and cortical synapses astrocytic D-serine rather than glycine, is the endogenous co-agonist of synaptic NMDA receptors (Papouin et al., 2012; Takata et al., 2011; Henneberger et al., 2010). By controlling the level of co-agonist site occupancy of postsynaptic NMDARs, astrocytic D-serine affects the level of activation of these receptors and thus activity-dependent long-term synaptic changes (Bains and Oliet, 2007). In particular, the additional burst of activation of postsynaptic NMDARs (about 25% more) induced by astrocyte D-serine release seems necessary for LTP induction (Henneberger et al., 2010). Moreover, in conditions of reduced synaptic coverage by astrocytes, such as during lactation in the hypothalamus, higher presynaptic activity is required to obtain LTP while the same level of activity that normally induces LTP results instead in LTD (Panatier et al., 2006). In such conditions, astrocyte-released D-serine is diluted in the larger extracellular space resulting in a reduced number of postsynaptic NMDARs recruited by synaptic activity, which ultimately translates into smaller postsynaptic Ca^{2+} increases. Therefore, experimental protocols that would be expected to cause LTP, elicit LTD instead. This is in agreement with the Bienenstock-Cooper-Munro (BCM) model for variation of the threshold

for LTP, which predicts that the relationship between synaptic activity and persistent changes in synaptic strength can vary according to the number of NMDARs available during synaptic activation (Abraham and Bear, 1996; Bienenstock et al., 1982). Effectively, by adjusting the D-serine occupancy of the NMDAR co-agonist-binding site, astrocytes can shift the relationship between activity and synaptic strength (Pاناتier et al., 2006).

Besides D-serine, experimental evidence hints that glutamate and ATP released from astrocytes could also directly bind postsynaptically-located receptors and accordingly, play a role in regulation of long-term synaptic plasticity. In the paraventricular nucleus of the hypothalamus for example, ATP released from astrocytes could directly target postsynaptic P_2X_7 receptors, promoting insertion of postsynaptic AMPARs which results in LTP of synaptic transmission (Gordon et al., 2005). Interestingly, ATP release is mediated by Ca^{2+} dynamics triggered in astrocytes by noradrenergic afferents which, in the hypothalamus, generally lack direct postsynaptic contacts (Sawyer and Clifton, 1980), thus hinting that signaling in this vital homeostatic circuit may require dynamic neuron-glia interactions.

Glutamate released from astrocyte could also target extrasynaptically-located NR_2B -containing NMDA receptors at postsynaptic terminals, triggering slow inward currents (SICs) (Navarrete et al., 2012; Pirttimaki et al., 2011; Bardoni et al., 2010; Navarrete and Araque, 2008; D'Ascenzo et al., 2007; Fellin et al., 2004) mainly mediated by Ca^{2+} ions (Cull-Candy et al., 2001), whose depolarizing action could affect postsynaptic neuronal firing (Pirttimaki et al., 2011; D'Ascenzo et al., 2007). In the primary visual cortex, nucleus basalis-mediated cholinergic activation of astrocytes mediates an increase of SICs frequency which correlates with a long-lasting increase of firing activity in visual responses of V1 excitatory neurons (Chen et al., 2012). The ensuing modulations of firing activity of these neurons by astrocyte-mediated SICs might ultimately affect STDP at individual synapses controlling orientation-specific responses of V1 neurons to visual stimuli (Jia et al., 2010).

Modulation of synaptic transmission by Ca^{2+} -dependent gliotransmission may not be limited to the very synapses that trigger Ca^{2+} activity in the astrocyte but it could also affect farther synaptic domains in a multimodal fashion (Kozlov et al., 2006), depending

both on the morphology of the sites of astrocyte-synapse reciprocal communication (Haber et al., 2006; Ventura and Harris, 1999) and the functional connectivity of the astrocytic network (Pannasch et al., 2011). High-frequency activity of a Schaffer collateral fiber can trigger the potentiation of synaptic transmission at the same fiber but heterosynaptic suppression of another, adjacent fiber, by inducing ATP release from an astrocyte interposed between the two fibers (Pascual et al., 2005; Zhang et al., 2003). In the somatosensory cortex in particular, astrocyte-mediated heterosynaptic suppression could modulate GABAergic inhibitory transmission (Benedetti et al., 2011) which plays a dominant role in the control of cortical neuronal excitability (Swadlow, 2002). Given that both experimental observations and theoretical arguments suggest that excitation and inhibition are globally balanced in cortical circuits (Haider et al., 2006; Shu et al., 2003; Troyer and Miller, 1997; Shadlen and Newsome, 1994), one may speculate that this mechanism could be involved in gating of signal transmission (Buzsáki, 2010). That is, by modulating inhibitory synaptic transmission, astrocytes could favor network excitation resulting in neuronal firing consistent with the transmission, i.e. gating ‘on’, of specific stimuli rather than others (Vogels and Abbott, 2009).

The latter idea could also bring to a possible role of astrocyte signaling in coherent function of neural networks underlying potential behavioral states (Engel et al., 2001). In cortical slices, for example, stimulation of a single astrocyte was reported to activate large portions of the astrocytic network and to result in an increase of synchronized neuronal depolarizations (Poskanzer and Yuste, 2011). This phenomenon was suggested to modulate the induction of cortical UP and DOWN states, possibly involved in determining the oscillatory activity observed in slow-wave sleep (Fellin et al., 2004; Poskanzer and Yuste, 2011; Halassa and Haydon, 2010) and is consistent with reports of sleep perturbations in mice lacking astrocytic gliotransmitter exocytosis (Fellin et al., 2012; Fellin et al., 2009; Halassa et al., 2009).

Conclusions

A large body of evidence has accumulated over the last years, suggesting an active role of astrocytes in many brain functions. Collectively these data have fuelled the concept that synapses could be tripartite rather than bipartite, since in addition to the pre- and post-synaptic terminals, the astrocyte could be an active element in synaptic transmission

(Haydon, 2001; Araque et al., 1999). While the tripartite synapse concept captures well the essence of astrocyte-regulated synapses, the inclusion of astrocytic signaling within our current knowledge of synaptic transmission could add more than just one level of complexity. Existing evidence suggests that astrocytes could produce not just tonic and diffuse modulatory influences on synapses but also engage in more focused, spatially precise and constrained communications with synaptic terminals (Bergersen et al., 2011; Santello and Volterra, 2009; Jourdain et al., 2007; Anderson and Swanson, 2000). This calls to rethink the definition of a functional synapse, to include the contribution from surrounding astrocytes. To conclude, the growing appreciation that astrocytes can regulate synaptic information at many levels, from activity of single synapses to network levels and behavioral states (Zorec et al., 2012; Halassa et al., 2009; Fellin et al., 2009) changes our understanding of brain communication and the role of glial cells in synaptic transmission. This resulting novel scenario offers an enticing platform for future theoretical investigations that we are just beginning to appreciate in its potential far-reaching implications.

Acknowledgments

The authors would like to thank Richard Robitaille, Mirko Santello and Ari Barzilai for insightful conversations and Nicolas Liaudet for critical reading of the manuscript. The authors' research was supported by the Tauber Family Foundation (MDP and EBJ); the Italy-Israel Joint Neuroscience Lab (MDP); the Maguy-Glass Chair in Physics of Complex Systems at Tel Aviv University (EBJ); the Center for Theoretical Biological Physics at Rice University sponsored by the National Science Foundation (NSF) (grant PHY-0822283) (EBJ); the NSF program in Physics of Living Systems (PoLS) at the University of Michigan (grant PHY-1058034) (EBJ); the National Institute of Health (grants R01 NS059740 and R01 NS060870 to T. Sejnowski and M. Bazhenov) (VV); the High Council for Scientific and Technological Cooperation between France-Israel (HB); the National Science Foundation (grant CBET 0943343) (VP); and the Swiss National Science Foundation (grant 31003A-140999 and NCCRs "Synapsy" and "Transcure") (AV).

References

- Abbott, L. F. and W. G. Regehr (2004). Synaptic computation. *Nature* 431, 796–803.
- Abbracchio, M. P., G. Burnstock, A. Verkhratsky, and H. Zimmermann (2009). Purinergic signalling in the nervous system: an overview. *Trends Neurosci.* 32, 19–29.
- Abraham, W. (2008). Metaplasticity: tuning synapses and networks for plasticity. *Nature Reviews Neuroscience* 9(5), 387–387.
- Abraham, W. and M. Bear (1996). Metaplasticity: the plasticity of synaptic plasticity. *Trends in Neurosciences* 19(4), 126–130.
- Aguado, F., J. F. Espinosa-Parrilla, M. A. Carmona, and E. Soriano (2002). Neuronal activity regulates correlated network properties of spontaneous calcium transients in astrocytes *in situ*. *J. Neurosci.* 22(21), 9430–9444.
- Agulhon, C., T. A. Fiacco, and K. D. McCarthy (2010). Hippocampal short- and long-term plasticity are not modulated by astrocyte Ca^{2+} signalling. *Science* 327, 1250–1254.
- Agulhon, C., J. Petravicz, A. B. McMullen, E. J. Sweger, S. K. Minton, S. R. Taves, K. B. Casper, T. A. Fiacco, and K. D. McCarthy (2008). What is the role of astrocyte calcium in neurophysiology? *Neuron* 59, 932–946.
- Allbritton, N. L., T. Meyer, and L. Stryer (1992). Range of messenger action of calcium ion and inositol 1,4,5-trisphosphate. *Science* 260, 107–260. Abstract.
- Anderson, M. C. and R. A. Swanson (2000). Astrocyte glutamate transport: review of properties, regulation, and physiological functions. *Glia* 32, 1–14.
- Andersson, M. and E. Hanse (2010). Astrocytes impose postburst depression of release probability at hippocampal glutamate synapses. *J. Neurosci.* 30(16), 5776–5780.
- Andersson, M. S. and Hanse (2011). Astrocyte-mediated short-term synaptic depression in the rat hippocampal CA1 area: two modes of decreasing release probability. *BMC Neurosci.* 12, 87.
- Araque, A., E. Martin, G. Perea, J. Arellano, and W. Buño (2002). Synaptically released acetylcholine evokes Ca^{2+} elevations in astrocytes in hippocampal slices. *The Journal of Neuroscience* 22(7), 2443–2450.

- Araque, A., V. Parpura, R. P. Sanzgiri, and P. G. Haydon (1998). Glutamate-dependent astrocyte modulation of synaptic transmission between cultured hippocampal neurons. *Eur. J. Neurosci.* 10, 2129–2142.
- Araque, A., V. Parpura, R. P. Sanzgiri, and P. G. Haydon (1999). Tripartite synapses: glia, the unacknowledged partner. *Trends Neurosci.* 23(5), 208–215.
- Araque, A., R. P. Sanzgiri, V. Parpura, and P. G. Haydon (1998). Calcium elevation in astrocytes causes an NMDA receptor-dependent increase in the frequency of miniature synaptic currents in cultured hippocampal neurons. *J. Neurosci.* 18(17), 6822–6829.
- Arizono, M., H. Bannai, K. Nakamura, F. Niwa, M. Enomoto, T. Matsu-ura, A. Miyamoto, M. W. Sherwood, T. Nakamura, and K. Mikoshiba (2012). Receptor-selective diffusion barrier enhances sensitivity of astrocytic processes to metabotropic glutamate receptor stimulation. *Sci. Signal.* 5(218), ra27.
- Auld, D. and R. Robitaille (2003). Glial cells and neurotransmission: an inclusive view of synaptic function. *Neuron* 40(2), 389–400.
- Bains, J. S. and S. H. R. Oliet (2007). Glia: they make your memories stick! *TRENDS Neurosci.* 30(8), 417–424.
- Balosso, S., T. Ravizza, M. Pierucci, E. Calcagno, R. Invernizzi, G. Di Giovanni, E. Esposito, and A. Vezzani (2009). Molecular and functional interactions between tumor necrosis factor-alpha receptors and the glutamatergic system in the mouse hippocampus: implications for seizure susceptibility. *Neuroscience* 161(1), 293–300.
- Bardoni, R., A. Ghirri, M. Zonta, C. Betelli, G. Vitale, V. Ruggieri, M. Sandrini, and G. Carmignoto (2010). Glutamate-mediated astrocyte-to-neuron signalling in the rat dorsal horn. *The Journal of Physiology* 588(5), 831–846.
- Barlow, H. (1996). Intraneuronal information processing, directional selectivity and memory for spatio-temporal sequences. *Network: Computation in Neural Systems* 7, 251–259.
- Barres, B. (2008). The mystery and magic of glia: a perspective on their roles in health and disease. *Neuron* 60(3), 430–440.

- Beattie, E., D. Stellwagen, W. Morishita, J. Bresnahan, B. Ha, M. Von Zastrow, M. Beattie, and R. Malenka (2002). Control of synaptic strength by glial TNF α . *Science* 295(5563), 2282–2285.
- Beierlein, M. and W. Regehr (2006). Brief bursts of parallel fiber activity trigger calcium signals in Bergmann glia. *The Journal of Neuroscience* 26(26), 6958–6967.
- Bekar, L., W. He, and M. Nedergaard (2008). Locus coeruleus α -adrenergic-mediated activation of cortical astrocytes in vivo. *Cerebral Cortex* 18(12), 2789–2795.
- Bélaïr, E., J. Vallée, and R. Robitaille (2010). *In vivo* long-term synaptic plasticity of glial cells. *The Journal of Physiology* 588(7), 1039–1056.
- Benedetti, B., V. Matyash, and H. Kettenmann (2011). Astrocytes control GABAergic inhibition of neurons in the mouse barrel cortex. *The Journal of Physiology* 589(5), 1159–1172.
- Bennett, M., L. Farnell, and W. Gibson (2008). A quantitative model of cortical spreading depression due to purinergic and gap-junction transmission in astrocyte networks. *Biophysical Journal* 95(12), 5648–5660.
- Bergersen, L., C. Morland, L. Ormel, J. Rinholm, M. Larsson, J. Wold, Å. Røe, A. Stranna, M. Santello, D. Bouvier, O. Ottersen, A. Volterra, and V. Gundersen (2011). Immunogold detection of L-glutamate and D-serine in small synaptic-like microvesicles in adult hippocampal astrocytes. *Cerebral Cortex*.
- Bergersen, L. H. and V. Gundersen (2009). Morphological evidence for vesicular glutamate release from astrocytes. *Neuroscience* 158, 260–265.
- Bernardinelli, Y., C. Salmon, E. Jones, W. Farmer, D. Stellwagen, and K. Murai (2011). Astrocytes display complex and localized calcium responses to single-neuron stimulation in the hippocampus. *The Journal of Neuroscience* 31(24), 8905–8919.
- Berridge, M. J. (1997). The AM and FM of calcium signaling. *Nature* 389, 759–760.
- Berridge, M. J., M. D. Bootman, and H. L. Roderick (2003). Calcium signalling: dynamics, homeostasis and remodelling. *Nature Rev.* 4, 517–529.
- Berry, H., M. De Pittà, V. Volman, and E. Ben-Jacob (2011). Astrocyte regulation of presynaptic plasticity. In *2011 Neuroscience Meeting Planner*, Washington, DC. Society for Neuroscience. Online.

- Bezprozvanny, I., J. Watras, and B. E. Ehrlich (1991). Bell-shaped calcium-response curves of Ins(1,4,5)P₃- and calcium-gated channels from endoplasmic reticulum of cerebellum. *Nature* 351, 751–754.
- Bezzi, P., G. Carmignoto, L. Pasti, S. Vesce, D. Rossi, B. Lodi Rizzini, T. Pozzan, and V. Volterra (1998). Prostaglandins stimulate calcium-dependent glutamate release in astrocytes. *Nature* 391, 281–285.
- Bezzi, P., M. Domercq, L. Brambilla, R. Galli, D. Schols, E. De Clercq, A. Vescovi, G. Bagetta, G. Kollias, J. Meldolesi, et al. (2001). CXCR4-activated astrocyte glutamate release via TNF α : amplification by microglia triggers neurotoxicity. *Nature Neuroscience* 4(7), 702–710.
- Bezzi, P., V. Gundersen, J. L. Galbete, G. Seifert, C. Steinhäuser, E. Pilati, and A. Volterra (2004). Astrocytes contain a vesicular compartment that is competent for regulated exocytosis of glutamate. *Nat. Neurosci.* 7(6), 613–620.
- Bienenstock, E., L. Cooper, and P. Munro (1982). Theory for the development of neuron selectivity: orientation specificity and binocular interaction in visual cortex. *The Journal of Neuroscience* 2(1), 32–48.
- Blaustein, M. and V. Golovina (2001). Structural complexity and functional diversity of endoplasmic reticulum Ca²⁺ stores. *Trends in Neurosciences* 24(10), 602–608.
- Bliss, T. and G. Collingridge (1993). A synaptic model of memory: long-term potentiation in the hippocampus. *Nature* 361(6407), 31–39.
- Blomstrand, F. and C. Giaume (2006). Kinetics of endothelin-induced inhibition and glucose permeability of astrocyte gap junctions. *Journal of Neuroscience Research* 83(6), 996–1003.
- Bonansco, C., A. Couve, G. Perea, C. A. Ferradas, M. Roncagliolo, and M. Fuenzalida (2011). Glutamate released spontaneously from astrocytes sets the threshold for synaptic plasticity. *Eur. J. Neurosci.* 33, 1483–1492.
- Bootman, M., P. Lipp, and M. Berridge (2001). The organisation and functions of local Ca²⁺ signals. *Journal of Cell Science* 114(12), 2213–2222.
- Bowser, D. and B. Khakh (2004). ATP excites interneurons and astrocytes to increase synaptic inhibition in neuronal networks. *The Journal of neuroscience* 24(39), 8606–8620.

- Bowser, D. N. and B. S. Khakh (2007). Two forms of single-vesicle astrocyte exocytosis imaged with total internal reflection fluorescence microscopy. *Proc. Natl. Acad. Sci. USA* 104(10), 4212–4217.
- Bushong, E. A., M. E. Martone, Y. Z. Jones, and M. H. Ellisman (2002). Protoplasmic astrocyte in CA1 stratum radiatum occupy separate anatomical domains. *J. Neurosci.* 22(1), 183–192.
- Buzsáki, G. (2010). Neural syntax: cell assemblies, synapsesembles, and readers. *Neuron* 68(3), 362–385.
- Carmignoto, G. (2000). Reciprocal communication systems between astrocytes and neurones. *Prog. Neurobiol.* 62, 561–581.
- Chan-Ling, T. and J. Stone (1991). Factors determining the morphology and distribution of astrocytes in the cat retina: A ‘contact-spacing’ model of astrocyte interaction. *J. Comp. Neurol.* 303(3), 387–399.
- Chen, N., H. Sugihara, J. Sharma, G. Perea, J. Petravicz, C. Le, and M. Sur (2012). Nucleus basalis enabled stimulus specific plasticity in the visual cortex is mediated by astrocytes. *Proceedings of the National Academy of Sciences*.
- Chen, X., L. Wang, Y. Zhou, L.-H. Zheng, and Z. Zhou (2005). “Kiss-and-run” glutamate secretion in cultured and freshly isolated rat hippocampal astrocytes. *J. Neurosci.* 25(40), 9236–9243.
- Coco, S., F. Calegari, E. Pravettoni, D. Pozzi, E. Taverna, P. Rosa, M. Matteoli, and C. Verderio (2003). Storage and release of ATP from astrocytes in culture. *J. Biol. Chem.* 278(2), 1354–1362.
- Codazzi, F., M. N. Teruel, and T. Meyer (2001). Control of astrocyte Ca^{2+} oscillations and waves by oscillating translocation and activation of protein kinase C. *Curr. Biol.* 11(14), 1089–1097.
- Communi, D., K. Gevaert, H. Demol, J. Vandekerckhove, and C. Erneux (2001). A novel receptor-mediated regulation mechanism of type I inositol polyphosphate 5-phosphatase by calcium/calmodulin-dependent protein kinase II phosphorylation. *J. Biol. Chem.* 276(42), 38738–38747.
- Communi, D., V. Vanweyenberg, and C. Erneux (1997). D-myo-inositol 1,4,5-trisphosphate 3-kinase A is activated by receptor activation through a

- calcium:calmodulin-dependent protein kinase II phosphorylation mechanism. *EMBO J.* 16(8), 1943–1952.
- Crippa, D., U. Schenk, M. Francolini, P. Rosa, C. Verderio, M. Zonta, T. Pozzan, M. Matteoli, and G. Carmignoto (2006). Synaptobrevin2-expressing vesicles in rat astrocytes: insights into molecular characterization, dynamics and exocytosis. *J. Physiol.* 570(3), 567–582.
- Cull-Candy, S., S. Brickley, and M. Farrant (2001). NMDA receptor subunits: diversity, development and disease. *Current Opinion in Neurobiology* 11(3), 327–335.
- D’Ascenzo, M., T. Fellin, M. Terunuma, R. Revilla-Sanchez, D. Meaney, Y. Auberson, S. Moss, and P. Haydon (2007). mGluR5 stimulates gliotransmission in the nucleus accumbens. *Proceedings of the National Academy of Sciences* 104(6), 1995.
- De Pittà, M., M. Goldberg, V. Volman, H. Berry, and E. Ben-Jacob (2009). Glutamate-dependent intracellular calcium and IP₃ oscillating and pulsating dynamics in astrocytes. *J. Biol. Phys.* 35, 383–411.
- De Pittà, M., V. Volman, H. Berry, and E. Ben-Jacob (2011). A tale of two stories: astrocyte regulation of synaptic depression and facilitation. *PLoS Comput. Biol.* 7(12), e1002293.
- De Pittà, M., V. Volman, H. Levine, and E. Ben-Jacob (2009). Multimodal encoding in a simplified model of intracellular calcium signaling. *Cogn. Proc.* 10(S1), 55–70.
- De Pittà, M., V. Volman, H. Levine, G. Pioggia, D. De Rossi, and E. Ben-Jacob (2008). Coexistence of amplitude and frequency modulations in intracellular calcium dynamics. *Phys. Rev. E* 77(3), 030903(R).
- De Saint Jan, D. and G. Westbrook (2005). Detecting activity in olfactory bulb glomeruli with astrocyte recording. *The Journal of Neuroscience* 25(11), 2917–2924.
- Del Castillo, J. and B. Katz (1954). Quantal components of the end-plate potential. *J. Physiol.* 124, 560–573.
- Deng, Q., M. Terunuma, T. Fellin, S. J. Moss, and P. Haydon (2011). Astrocytic activation of A1 receptors regulates the surface expression of NMDA receptors through a src kinase dependent pathway. *Glia* 59, 1084–1093.

- Di Castro, M., J. Chuquet, N. Liaudet, K. Bhaukaurally, M. Santello, D. Bouvier, P. Tiret, and A. Volterra (2011). Local Ca^{2+} detection and modulation of synaptic release by astrocytes. *Nature Neuroscience* 14, 1276–1284.
- Domercq, M., L. Brambilla, E. Pilati, J. Marchaland, A. Volterra, and P. Bezzi (2006). P2Y1 receptor-evoked glutamate exocytosis from astrocytes: control by tumor necrosis factor- α and prostaglandins. *J. Biol. Chem.* 281, 30684–30696.
- Dundwiddie, T. V. and S. A. Masino (2001). The role and regulation of adenosine in the central nervous system. *Ann. Rev. Neurosci.* 24, 31–55.
- Dupont, G., E. Loomekandja Lokenye, and R. Challiss (2011). A model for Ca^{2+} oscillations stimulated by the type 5 metabotropic glutamate receptor: an unusual mechanism based on repetitive, reversible phosphorylation of the receptor. *Biochimie* 93, 2132–2138.
- Emptage, N. J., C. A. Reid, and A. Fine (2001). Calcium stores in hippocampal synaptic boutons mediate short-term plasticity, store-operated Ca^{2+} entry, and spontaneous transmitter release. *Neuron* 29, 197–208.
- Engel, A., P. Fries, W. Singer, et al. (2001). Dynamic predictions: oscillations and synchrony in top-down processing. *Nature Reviews Neuroscience* 2(10), 704–716.
- Enkvist, M. O. and K. D. McCarthy (1992). Activation of protein kinase C blocks astroglial gap junction communication and inhibits the spread of calcium waves. *J. Neurochem.* 59(2), 519–526.
- Ermentrout, G. and D. Terman (2010). *Mathematical foundations of neuroscience*. New York, NY: Springer Verlag.
- Falcke, M. (2004). Reading the patterns in living cells - the physics of Ca^{2+} signaling. *Adv. Phys.* 53(3), 255–440.
- Feldman, D. and M. Brecht (2005). Map plasticity in somatosensory cortex. *Science* 310(5749), 810.
- Fellin, T., J. M. Ellenbogen, M. De Pittà, E. Ben-Jacob, and M. Halassa (2012). Astrocyte regulation of sleep circuits: experimental and modeling perspectives. *Front. Comput. Neurosci.* 6(65).
- Fellin, T., M. Halassa, M. Terunuma, F. Succol, H. Takano, M. Frank, S. Moss, and P. Haydon (2009). Endogenous nonneuronal modulators of synaptic transmission

- control cortical slow oscillations in vivo. *Proceedings of the National Academy of Sciences* 106(35), 15037–15042.
- Fellin, T., O. Pascual, S. Gobbo, T. Pozzan, P. G. Haydon, and G. Carmignoto (2004). Neuronal synchrony mediated by astrocytic glutamate through activation of extrasynaptic NMDA receptors. *Neuron* 43, 729–743.
- Ferguson, A., R. Christensen, J. Gensel, B. Miller, F. Sun, E. Beattie, J. Bresnahan, and M. Beattie (2008). Cell death after spinal cord injury is exacerbated by rapid TNF α -induced trafficking of GluR2-lacking AMPARs to the plasma membrane. *The Journal of Neuroscience* 28(44), 11391–11400.
- Fiacco, T. A., C. Agulhon, S. R. Taves, J. Petravic, K. B. Casper, X. Dong, J. Chen, and K. D. McCarthy (2007). Selective stimulation of astrocyte calcium in situ does not affect neuronal excitatory synaptic activity. *Neuron* 54, 611–626.
- Fiacco, T. A. and K. D. McCarthy (2004). Intracellular astrocyte calcium waves *in situ* increase the frequency of spontaneous AMPA receptor currents in CA1 pyramidal neurons. *J. Neurosci.* 24(3), 722–732.
- Fukaya, M., M. Uchigashima, S. Nomura, Y. Hasegawa, H. Kikuchi, and M. Watanabe (2008). Predominant expression of phospholipase C β 1 in telencephalic principal neurons and cerebellar interneurons, and its close association with related signaling molecules in somatodendritic neuronal elements. *European Journal of Neuroscience* 28(9), 1744–1759.
- García-Marqués, J. and L. López-Mascaraque (2012). Clonal identity determines astrocyte cortical heterogeneity. *Cereb. Cortex*.
- Giaume, C., A. Koulakoff, L. Roux, D. Holcman, and N. Rouach (2010). Astroglial networks: a step further in neuroglial and gliovascular interactions. *Nature Reviews Neuroscience* 11(2), 87–99.
- Goldberg, M., M. De Pittà, V. Volman, H. Berry, and E. Ben-Jacob (2010). Nonlinear gap junctions enable long-distance propagation of pulsating calcium waves in astrocyte networks. *PLoS Comput. Biol.* 6(8), e1000909.
- Gordon, G., D. Baimoukhametova, S. Hewitt, W. Rajapaksha, T. Fisher, and J. Bains (2005). Norepinephrine triggers release of glial ATP to increase postsynaptic efficacy. *Nature Neuroscience* 8(8), 1078–1086.

- Gordon, G. R. J., K. J. Iremonger, S. Kantevari, G. C. R. Ellis-Davies, B. A. MacVicar, and J. S. Bains (2009). Astrocyte-mediated distributed plasticity at hypothalamic glutamate synapses. *Neuron* 64, 391–403.
- Grosche, J., V. Matyash, T. Möller, A. Verkhratsky, A. Reichenbach, and H. Kettenmann (1999). Microdomains for neuron-glia interaction: parallel fiber signaling to bergmann glial cells. *Nature* 2(2), 139–143.
- Guthrie, P. B., J. Knappenberger, M. Segal, C. A. C. Bennett, M. V. L., and S. B. Kater (1999). ATP released from astrocytes mediates glial calcium waves. *J. Neurosci.* 19, 520–528.
- Haas, B., C. G. Schipke, O. Peters, G. Sohl, K. Willecke, and H. Kettenmann (2006). Activity-dependent ATP-waves in the mouse neocortex are independent from astrocytic calcium waves. *Cereb. Cortex* 16, 237–246.
- Haber, M., L. Zhou, and K. K. Murai (2006). Cooperative astrocyte and dendritic spine dynamics at hippocampal excitatory synapses. *J. Neurosci.* 26(35), 8881–8891.
- Haider, B., A. Duque, A. Hasenstaub, and D. McCormick (2006). Neocortical network activity in vivo is generated through a dynamic balance of excitation and inhibition. *The Journal of neuroscience* 26(17), 4535–4545.
- Halassa, M., C. Florian, T. Fellin, J. Munoz, S. Lee, T. Abel, P. Haydon, and M. Frank (2009). Astrocytic modulation of sleep homeostasis and cognitive consequences of sleep loss. *Neuron* 61(2), 213–219.
- Halassa, M. and P. Haydon (2010). Integrated brain circuits: astrocytic networks modulate neuronal activity and behavior. *Annual Review of Physiology* 72, 335–355.
- Haydon, P. G. (2001). Glia: listening and talking to the synapse. *Nature Rev. Neurosci.* 2, 185–193.
- Haydon, P. G. and G. Carmignoto (2006). Astrocyte control of synaptic transmission and neurovascular coupling. *Physiol. Rev.* 86, 1009–1031.
- Henneberger, C., T. Papouin, S. H. R. Oliet, and D. A. Rusakov (2010). Long-term potentiation depends on release of D-serine from astrocytes. *Nature* 463, 232–237.
- Hensch, T. (2005). Critical period plasticity in local cortical circuits. *Nature Reviews Neuroscience* 6(11), 877–888.

- Herman, M. A. and C. E. Jahr (2007). Extracellular glutamate concentration in hippocampal slice. *J. Neurosci.* 27(36), 9736–9741.
- Hirase, H., L. Qian, P. Barthó, and G. Buzsáki (2004). Calcium dynamics of cortical astrocytic networks *in vivo*. *PLoS Biol.* 2(4), 0494–0496.
- Houades, V., A. Koulakoff, P. Ezan, I. Seif, and C. Giaume (2008). Gap junction-mediated astrocytic networks in the mouse barrel cortex. *The Journal of Neuroscience* 28(20), 5207–5217.
- Iacobas, D. A., S. O. Suadicani, D. C. Spray, and E. Scemes (2006). A stochastic two-dimensional model of intercellular Ca^{2+} wave spread in glia. *Biophys. J.* 90, 24–41.
- Iino, M. (1990). Biphasic Ca^{2+} -dependence of inositol 1,4,5-trisphosphate-induced Ca^{2+} release in smooth muscle cells of the guinea pig *Taenia caeci*. *J. Gen. Physiol.* 95, 1103–1112.
- Irvine, R. F., S. M. Lloyd-Burton, J. C. H. Yu, A. J. Letcher, and M. J. Schell (2006). The regulation and function of inositol 1,4,5-trisphosphate 3-kinase. *Advan. Enzyme Regul.* 46, 314–323.
- Jaiswal, J., M. Fix, T. Takano, M. Nedergaard, and S. Simon (2007). Resolving vesicle fusion from lysis to monitor calcium-triggered lysosomal exocytosis in astrocytes. *Proceedings of the National Academy of Sciences* 104(35), 14151–14156.
- Jia, H., N. Rochefort, X. Chen, and A. Konnerth (2010). Dendritic organization of sensory input to cortical neurons *in vivo*. *Nature* 464(7293), 1307–1312.
- Jourdain, P., L. H. Bergersen, K. Bhaukaurally, P. Bezzi, M. Santello, M. Domercq, C. Matute, F. Tonello, V. Gundersen, and A. Volterra (2007). Glutamate exocytosis from astrocytes controls synaptic strength. *Nature Neurosci.* 10(3), 331–339.
- Kaftan, E. J., B. E. Erlich, and J. Watras (1997). Inositol 1,4,5-trisphosphate (InsP_3) and calcium interact to increase the dynamic range of InsP_3 receptor-dependent calcium signaling. *J. Gen. Physiol.* 110, 529–538.
- Kang, J., L. Jiang, S. A. Goldman, and M. Nedergaard (1998). Astrocyte-mediated potentiation of inhibitory synaptic transmission. *Nat. Neurosci.* 1(8), 683–692.
- Kang, M. and H. Othmer (2009). Spatiotemporal characteristics of calcium dynamics in astrocytes. *Chaos* 19(3), 037116.

- Kang, N., J. Xu, Q. Xu, M. Nedergaard, and J. Kang (2005). Astrocytic glutamate release-induced transient depolarization and epileptiform discharges in hippocampal CA1 pyramidal neurons. *J. Neurophysiol.* 94, 4121–4130.
- Keizer, J., Y. Li, S. Stojilkovic, and J. Rinzel (1995). InsP₃-induced Ca²⁺ excitability of the endoplasmic reticulum. *Mol. Biol. of the Cell* 6, 945–951.
- Kozlov, A. S., M. C. Angulo, E. Audinat, and S. Charpak (2006). Target cell-specific modulation of neuronal activity by astrocytes. *Proceedings of the National Academy of Sciences* 103(26), 10058–10063.
- Kreft, M., M. Stenovec, M. Rupnik, S. Grilc, M. Kržan, M. Potokar, T. Pangršič, P. G. Haydon, and R. Zorec (2004). Properties of Ca²⁺-dependent exocytosis in cultured astrocytes. *Glia* (46), 437–445.
- Kuga, N., T. Sasaki, Y. Takahara, N. Matsuki, and Y. Ikegaya (2011). Large-scale calcium waves traveling through astrocytic networks *in vivo*. *J. Neurosci.* 31(7), 2607–2614.
- Kulik, A., A. Haentzsch, M. Lüchermann, W. Reichelt, and K. Ballanyi (1999). Neuron-glia signaling via α_1 adrenoreceptor-mediated Ca²⁺ release in Bergmann glial cells *in situ*. *J. Neurosci.* 19(19), 8401–8408.
- Lallouette, J. and H. Berry (2012, September 2012). Topology drives calcium wave propagation in 3D astrocyte networks. In *European Conference on Complex Systems 2012*, Bruxelles.
- Larsson, M., K. Sawada, C. Morland, M. Hiasa, L. Ormel, Y. Moriyama, and V. Gundersen (2011). Functional and anatomical identification of a vesicular transporter mediating neuronal ATP release. *Cerebral Cortex* 22(5), 1203–1214.
- Lavialle, M., G. Aumann, E. Anlauf, F. Pröls, M. Arpin, and A. Derouiche (2011). Structural plasticity of perisynaptic astrocyte processes involves ezrin and metabotropic glutamate receptors. *Proc. Nat. Acad. Sci. USA*, 1–5.
- Le Meur, K., J. Mendizabal-Zubiaga, P. Grandes, and E. Audinat (2012). GABA release by hippocampal astrocytes. *Frontiers in Computational Neuroscience* 6.
- Lee, M., E. McGeer, and P. McGeer (2011). Mechanisms of GABA release from human astrocytes. *Glia* 59, 1600–1611.

- Lee, S., B. Yoon, K. Berglund, S. Oh, H. Park, H. Shin, G. Augustine, and C. Lee (2010). Channel-mediated tonic GABA release from glia. *Science's STKE* 330(6005), 790–796.
- Li, D., N. Ropert, A. Koulakoff, C. Giaume, and M. Oheim (2008). Lysosomes are the major vesicular compartment undergoing Ca^{2+} -regulated exocytosis from cortical astrocytes. *The Journal of Neuroscience* 28(30), 7648–7658.
- Li, L., K. Bender, P. Drew, S. Jadhav, E. Sylwestrak, and D. Feldman (2009). Endocannabinoid signaling is required for development and critical period plasticity of the whisker map in somatosensory cortex. *Neuron* 64(4), 537–549.
- Li, Y.-X., J. Rinzel, J. Keizer, and S. S. Stojilkovic (1994). Calcium oscillations in pituitary gonadotrophs: comparison of experiment and theory. *Proc. Natl. Acad. Sci. USA* 91, 58–62.
- Liu, Q., Q. Xu, G. Arcuino, J. Kang, and M. Nedergaard (2004). Astrocyte-mediated activation of neuronal kainate receptors. *Proceedings of the National Academy of Sciences USA* 101(9), 3172–3177.
- Liu, Q.-S., Q. Xu, J. Kang, and M. Nedergaard (2004). Astrocyte activation of presynaptic metabotropic glutamate receptors modulates hippocampal inhibitory synaptic transmission. *Neuron Glia Biol.* 1, 307–316.
- Lovatt, D., Q. Xu, W. Liu, T. Takano, N. Smith, J. Schnermann, K. Tieu, and M. Nedergaard (2012). Neuronal adenosine release, and not astrocytic ATP release, mediates feedback inhibition of excitatory activity. *Proceedings of the National Academy of Sciences*.
- Mak, D., S. McBride, and J. Foskett (2003). Spontaneous channel activity of the inositol 1, 4, 5-trisphosphate (InsP_3) receptor (InsP_3R). Application of allosteric modeling to calcium and InsP_3 regulation of InsP_3R single-channel gating. *The Journal of General Physiology* 122(5), 583–603.
- Malarkey, E., Y. Ni, and V. Pappas (2008). Ca^{2+} entry through TRPC1 channels contributes to intracellular Ca^{2+} dynamics and consequent glutamate release from rat astrocytes. *Glia* 56(8), 821–835.

- Malarkey, E. and V. Parpura (2011). Temporal characteristics of vesicular fusion in astrocytes: examination of synaptobrevin 2-laden vesicles at single vesicle resolution. *The Journal of Physiology* 589(17), 4271–4300.
- Marchaland, J., C. Cali, S. M. Voglmaier, H. Li, R. Regazzi, R. H. Edwards, and P. Bezzi (2008). Fast subplasma membrane Ca^{2+} transients control exo-endocytosis of synaptic-like microvesicles in astrocytes. *J. Neurosci.* 28(37), 9122–9132.
- Matyash, V., V. Filippov, K. Mohrhagen, and H. Kettenmann (2001). Nitric oxide signals parallel fiber activity to Bergmann glial cells in the mouse cerebellar slice. *Mol. Cell. Neurosci.* 18(6), 664–670(7). Abstract.
- Matyash, V. and H. Kettenmann (2010). Heterogeneity in astrocyte morphology and physiology. *Brain Research Reviews* 63(1-2), 2–10.
- Min, R. and T. Nevian (2012). Astrocyte signaling controls spike timing-dependent depression at neocortical synapses. *Nature Neuroscience* 15(5), 746–753.
- Mishra, J. and U. S. Bhalla (2002). Simulations of inositol phosphate metabolism and its interaction with InsP_3 -mediated calcium release. *Biophys. J.* 83, 1298–1316.
- Montana, V., E. B. Malarkey, C. Verderio, M. Matteoli, and V. Parpura (2006). Vesicular transmitter release from astrocytes. *Glia* 54, 700–715.
- Montana, V., Y. Ni, V. Sunjara, X. Hua, and V. Parpura (2004). Vesicular glutamate transporter-dependent glutamate release from astrocytes. *J. Neurosci.* 24(11), 2633–2642.
- Mulligan, S. and B. MacVicar (2004). Calcium transients in astrocyte endfeet cause cerebrovascular constrictions. *Nature* 431(7005), 195–199.
- Muyderman, H., M. Ängelsten, M. Sandberg, U. Björklund, T. Olsson, E. Hansson, and M. Nilsson (2001). $\alpha 1$ -Adrenergic modulation of metabotropic glutamate receptor-induced calcium oscillations and glutamate release in astrocytes. *Journal of Biological Chemistry* 276(49), 46504–46514.
- Navarrete, M. and A. Araque (2008). Endocannabinoids mediate neuron-astrocyte communication. *Neuron* 57(6), 883–893.
- Navarrete, M. and A. Araque (2010). Endocannabinoids potentiate synaptic transmission through stimulation of astrocytes. *Neuron* 68(1), 113–126.

- Navarrete, M. and A. Araque (2011). Basal synaptic transmission: astrocytes rule! *Cell* 146(5), 675–677.
- Navarrete, M., G. Perea, D. de Sevilla, M. Gómez-Gonzalo, A. Núñez, E. Martín, and A. Araque (2012). Astrocytes mediate in vivo cholinergic-induced synaptic plasticity. *PLoS Biology* 10(2), e1001259.
- Navarrete, M., G. Perea, L. Maglio, J. Pastor, R. García de Sola, and A. Araque (2012). Astrocyte calcium signal and gliotransmission in human brain tissue. *Cereb. Cortex*.
- Nett, W. J., S. H. Oloff, and K. D. McCarthy (2002). Hippocampal astrocytes in situ exhibit calcium oscillations that occur independent of neuronal activity. *J. Neurophysiol.* 87, 528–537.
- Newman, E. (2005). Calcium increases in retinal glial cells evoked by light-induced neuronal activity. *The Journal of Neuroscience* 25(23), 5502–5510.
- Newman, E. A. (2003). Glial cell inhibition of neurons by release of ATP. *J. Neurosci.* 23(5), 1659–1666.
- Newman, E. A. and K. R. Zahs (1997). Calcium waves in retinal glial cells. *Science* 275, 844–847.
- Ni, Y., E. B. Malarkey, and V. Pappas (2007). Vesicular release of glutamate mediates bidirectional signaling between astrocytes and neurons. *J. Neurochem.* 103(4), 1273–1284.
- Nimmerjahn, A. (2009). Astrocytes going live: advances and challenges. *J. Physiol.* 587, 1639–1647.
- Nimmerjahn, A., F. Kirchhoff, J. N. D. Kerr, and F. Helmchen (2004). Sulforhodamine 101 as a specific marker of astroglia in the neocortex *in vivo*. *Nat. Methods* 1, 31–37.
- Okubo, Y., H. Sekiya, S. Namiki, H. Sakamoto, S. Iinuma, M. Yamasaki, M. Watanabe, K. Hirose, and M. Iino (2010). Imaging extrasynaptic glutamate dynamics in the brain. *Proc. Nat. Acad. Sci. USA* 107(14), 6526–6531.
- Oliet, S. H. R., R. Piet, and D. A. Poulain (2001). Control of glutamate clearance and synaptic efficacy by glial coverage of neurons. *Science* 292, 923–926.

- Panatier, A., D. T. Theodosis, J. P. Mothet, B. Touquet, L. Pollegioni, D. A. Poulain, and S. H. Oliet (2006). Glia-derived D-serine controls NMDA receptor activity and synaptic memory. *Cell* 125, 775–784.
- Panatier, A., J. Vallée, M. Haber, K. Murai, J. Lacaille, and R. Robitaille (2011). Astrocytes are endogenous regulators of basal transmission at central synapses. *Cell* 146, 785–798.
- Pangršić, T., M. Potokar, M. Stenovec, M. Kreft, E. Fabbretti, A. Nistri, E. Pryazhnikov, L. Khiroug, R. Giniatullin, and R. Zorec (2007). Exocytotic release of ATP from cultured astrocytes. *Journal of Biological Chemistry* 282(39), 28749–28758.
- Pankratov, Y., U. Lalo, A. Verkhratsky, and R. North (2007). Quantal release of ATP in mouse cortex. *The Journal of General Physiology* 129(3), 257–265.
- Pannasch, U., L. Vargová, J. Reingruber, P. Ezan, D. Holcman, C. Giaume, E. Syková, and N. Rouach (2011). Astroglial networks scale synaptic activity and plasticity. *Proceedings of the National Academy of Sciences* 108(20), 8467–8472.
- Papouin, T., L. Ladépêche, J. Ruel, S. Sacchi, M. Labasque, M. Hanini, L. Groc, L. Pollegioni, J. Mothet, and S. Oliet (2012). Synaptic and extrasynaptic NMDA receptors are gated by different endogenous coagonists. *Cell* 150(3), 633–646.
- Parpura, V., Y. Fang, T. Basarsky, R. Jahn, and P. G. Haydon (1995). Expression of synaptobrevin II, cellubrevin and syntaxin but not SNAP-25 in cultured astrocytes. *FEBS Lett.* 377, 489–492.
- Parpura, V., V. Grubišić, and A. Verkhratsky (2011). Ca²⁺ sources for the exocytotic release of glutamate from astrocytes. *Biochim. Biophys. Acta* 1813(5), 984–991.
- Parpura, V. and P. G. Haydon (2000). Physiological astrocytic calcium levels stimulate glutamate release to modulate adjacent neurons. *Proc. Natl. Acad. Sci. USA* 97(15), 8629–8634.
- Parpura, V. and R. Zorec (2010). Gliotransmission: exocytotic release from astrocytes. *Brain Res. Rev.* 63, 83–92.
- Parri, H. R., T. M. Gould, and V. Crunelli (2001). Spontaneous astrocytic Ca²⁺ oscillations in situ drive NMDAR-mediated neuronal excitation. *Nature Neurosci.* 4(8), 803–812.

- Pascual, O., K. B. Casper, C. Kubera, J. Zhang, R. Revilla-Sanchez, J. Y. Sul, H. Takano, S. J. Moss, K. McCarthy, and P. G. Haydon (2005). Astrocytic purinergic signaling coordinates synaptic networks. *Science* 310, 113–116.
- Pasti, L., A. Volterra, T. Pozzan, and G. Carmignoto (1997). Intracellular calcium oscillations in astrocytes: a highly plastic, bidirectional form of communication between neurons and astrocytes *in situ*. *J. Neurosci.* 17(20), 7817–7830.
- Pasti, L., M. Zonta, T. Pozzan, S. Vicini, and G. Carmignoto (2001). Cytosolic calcium oscillations in astrocytes may regulate exocytotic release of glutamate. *J. Neurosci.* 21(2), 477–484.
- Perea, G. and A. Araque (2005). Properties of synaptically evoked astrocyte calcium signal reveal synaptic information processing by astrocyte. *J. Neurosci.* 25(9), 2192–2203.
- Perea, G. and A. Araque (2007). Astrocytes potentiate transmitter release at single hippocampal synapses. *Science* 317, 1083–1086.
- Perea, G., M. Navarrete, and A. Araque (2009). Tripartite synapse: astrocytes process and control synaptic information. *Trends Neurosci.* 32, 421–431.
- Petravicz, J., T. Fiacco, and K. McCarthy (2008). Loss of IP₃ receptor-dependent Ca²⁺ increases in hippocampal astrocytes does not affect baseline CA1 pyramidal neuron synaptic activity. *The Journal of Neuroscience* 28(19), 4967–4973.
- Piet, R. and C. Jahr (2007). Glutamatergic and purinergic receptor-mediated calcium transients in Bergmann glial cells. *The Journal of Neuroscience* 27(15), 4027–4035.
- Piet, R., L. Vargová, E. Syková, D. Poulain, and S. Oliet (2004). Physiological contribution of the astrocytic environment of neurons to intersynaptic crosstalk. *Proceedings of the National Academy of Sciences USA* 101(7), 2151–2155.
- Pinheiro, P. S. and C. Mulle (2008). Presynaptic glutamate receptors: physiological functions and mechanisms of action. *Nature Rev.* 9, 423–436.
- Pirttimaki, T., S. Hall, and H. Parri (2011). Sustained neuronal activity generated by glial plasticity. *The Journal of Neuroscience* 31(21), 7637–7647.
- Pivneva, T., B. Haas, D. Reyes-Haro, G. Laube, R. Veh, C. Nolte, G. Skibo, and H. Kettenmann (2008). Store-operated Ca²⁺ entry in astrocytes: different spatial

- arrangement of endoplasmic reticulum explains functional diversity in vitro and in situ. *Cell calcium* 43(6), 591–601.
- Porter, J. T. and K. D. McCarthy (1996). Hippocampal astrocytes *in situ* respond to glutamate released from synaptic terminals. *J. Neurosci.* 16(16), 5073–5081.
- Poskanzer, K. and R. Yuste (2011). Astrocytic regulation of cortical UP states. *Proceedings of the National Academy of Sciences.*
- Pryazhnikov, E. and L. Khiroug (2008). Sub-micromolar increase in $[Ca^{2+}]_i$ triggers delayed exocytosis of ATP in cultured astrocytes. *Glia* 56(1), 38–49.
- Raghavachari, S. and J. E. Lisman (2004). Properties of quantal transmission at CA1 synapses. *J. Neurophysiol.* 92, 2456–2467.
- Rebecchi, M. J. and S. N. Pentylala (2000). Structure, function, and control of phosphoinositide-specific phospholipase C. *Physiol. Rev.* 80(4), 1291–1335.
- Rebola, N., R. Rodrigues, L. Lopes, P. Richardson, C. Oliveira, and R. Cunha (2005). Adenosine A_1 and A_{2A} receptors are co-expressed in pyramidal neurons and co-localized in glutamatergic nerve terminals of the rat hippocampus. *Neuroscience* 133(1), 79–83.
- Regehr, W. F., K. R. Delaney, and D. W. Tank (1994). The role of presynaptic calcium in short-term enhancement at the hippocampal mossy fiber synapse. *J. Neurosci.* 14, 523–537.
- Rieger, A., J. Deitmer, and C. Lohr (2007). Axon-glia communication evokes calcium signaling in olfactory ensheathing cells of the developing olfactory bulb. *Glia* 55(4), 352–359.
- Robitaille, R. (1998). Modulation of synaptic efficacy and synaptic depression by glial cells at the frog neuromuscular junction. *Neuron* 21(4), 847–855.
- Rodríguez-Moreno, A. and O. Paulsen (2008). Spike timing-dependent long-term depression requires presynaptic nmda receptors. *Nature Neuroscience* 11(7), 744–745.
- Rossi, D. (2012). Astrocytes join the plasticity party. *Nature Neuroscience* 15(5), 649–651.

- Rouach, N., A. Koulakoff, and C. Giaume (2004). Neurons set the tone of gap junctional communication in astrocytic networks. *Neurochemistry International* 45(2-3), 265–272.
- Rousse, I., A. St.-Amour, H. Darabid, and R. Robitaille (2010). Synapse-glia interactions are governed by synaptic and intrinsic glial properties. *Neuroscience* 167, 621–632.
- Roux, L., K. Benchenane, J. Rothstein, G. Bonvento, and C. Giaume (2011). Plasticity of astroglial networks in olfactory glomeruli. *Proceedings of the National Academy of Sciences* 108(45), 18442–18446.
- Santello, M., P. Bezzi, and A. Volterra (2011). TNF α controls glutamatergic gliotransmission in the hippocampal dentate gyrus. *Neuron* 69, 988–1001.
- Santello, M. and A. Volterra (2009). Synaptic modulation by astrocytes via Ca²⁺-dependent glutamate release. *Neuroscience* 158(1), 253–259.
- Santello, M. and A. Volterra (2010). Astrocytes as aide-mémoires. *Nature* 463, 169–170.
- Santello, M. and A. Volterra (2012). TNF α in synaptic function: switching gears. *Trends in Neurosci.*
- Sasaki, T., N. Matsuki, and Y. Ikegaya (2011). Action-potential modulation during axonal conduction. *Science* 331(6017), 599–601.
- Sawada, K., N. Echigo, N. Juge, T. Miyaji, M. Otsuka, H. Omote, A. Yamamoto, and Y. Moriyama (2008). Identification of a vesicular nucleotide transporter. *Proceedings of the National Academy of Sciences* 105(15), 5683–5686.
- Sawyer, C. and D. Clifton (1980). Aminergic innervation of the hypothalamus. In *Federation Proceedings*, Volume 39, pp. 2889–2895.
- Scemes, E. and C. Giaume (2006). Astrocyte calcium waves: What they are and what they do. *Glia* 54, 716–725.
- Schipke, C., B. Haas, and H. Kettenmann (2008). Astrocytes discriminate and selectively respond to the activity of a subpopulation of neurons within the barrel cortex. *Cerebral Cortex* 18(10), 2450–2459.
- Schmitt, L., R. Sims, N. Dale, and P. Haydon (2012). Wakefulness affects synaptic and network activity by increasing extracellular astrocyte-derived adenosine. *The Journal of Neuroscience* 32(13), 4417–4425.

- Schubert, V., D. Bouvier, and A. Volterra (2011). SNARE protein expression in synaptic terminals and astrocytes in the adult hippocampus: A comparative analysis. *Glia* 59(10), 1472–1488.
- Schummers, J., H. Yu, and M. Sur (2008). Tuned responses of astrocytes and their influence on hemodynamic signals in the visual cortex. *Science's STKE* 320(5883), 1638.
- Sejnowski, T. J. and O. Paulsen (2006). Network oscillations: emerging computational principles. *J. Neurosci.* 26(6), 1673–1676.
- Serrano, A., N. Haddjeri, J. Lacaille, and R. Robitaille (2006). GABAergic network activation of glial cells underlies heterosynaptic depression. *J. Neurosci.* 26(20), 5370–5382.
- Shadlen, M. and W. Newsome (1994). Noise, neural codes and cortical organization. *Current Opinion in Neurobiology* 4(4), 569–579.
- Shigemoto, R., A. Kinoshita, E. Wada, S. Nomura, H. Ohishi, M. Takada, P. Flor, A. Neki, T. Abe, S. Nakanishi, and N. Mizuno (1997). Differential presynaptic localization of metabotropic glutamate receptor subtypes in the rat hippocampus. *The Journal of Neuroscience* 17(19), 7503–7522.
- Shigetomi, E., X. Tong, K. Kwan, D. Corey, and B. Khakh (2011). TRPA1 channels regulate astrocyte resting calcium levels and inhibitory synapse efficacy via GAT-3. *Nature Neuroscience* 15(1), 70–80.
- Shinohara, T., T. Michikawa, M. Enomoto, J. Goto, M. Iwai, T. Matsu-ura, H. Yamazaki, A. Miyamoto, A. Suzuki, and K. Mikoshiba (2011). Mechanistic basis of bell-shaped dependence of inositol 1,4,5-trisphosphate receptor gating on cytosolic calcium. *Proceedings of the National Academy of Sciences* 108(37), 15486–15491.
- Shu, Y., A. Hasenstaub, and D. McCormick (2003). Turning on and off recurrent balanced cortical activity. *Nature* 423(6937), 288–293.
- Sims, C. E. and N. L. Allbritton (1998). Metabolism of inositol 1,4,5-trisphosphate and inositol 1,3,4,5-tetrakisphosphate by the oocytes of *Xenopus laevis*. *J. Biol. Chem.* 273(7), 4052–4058.

- Sjöström, P., G. Turrigiano, and S. Nelson (2003). Neocortical LTD via coincident activation of presynaptic NMDA and cannabinoid receptors. *Neuron* 39(4), 641–654.
- Sneyd, J., A. C. Charles, and M. J. Sanderson (1994). A model for the propagation of intracellular calcium waves. *Am. J. Physiol.* 266(35), C293–C302.
- Stellwagen, D., E. C. Beattie, J. Y. Seo, and R. C. Malenka (2005). Differential regulation of AMPA receptor and GABA receptor trafficking by tumor necrosis factor- α . *The Journal of Neuroscience* 25(12), 3219–3228.
- Stellwagen, D. and R. Malenka (2006). Synaptic scaling mediated by glial TNF- α . *Nature* 440(7087), 1054–1059.
- Stenovec, M., S. Kreft, M. Grilc, M. Pokotar, M. E. Kreft, T. Pangršič, and R. Zorec (2007). Ca²⁺-dependent mobility of vesicles capturing anti-VGLUT1 antibodies. *Exp. Cell Res.* 313, 3809–3818.
- Sul, J.-Y., G. Orosz, R. S. Givens, and P. G. Haydon (2004). Astrocytic connectivity in the hippocampus. *Neuron Glia Biol.* 1, 3–11.
- Svoboda, K., W. Denk, D. Kleinfeld, D. Tank, et al. (1997). *In vivo* dendritic calcium dynamics in neocortical pyramidal neurons. *Nature* 385(6612), 161–165.
- Swadlow, H. (2002). Thalamocortical control of feed–forward inhibition in awake somatosensory ‘barrel’ cortex. *Philosophical Transactions of the Royal Society of London. Series B: Biological Sciences* 357(1428), 1717–1727.
- Syková, E. and C. Nicholson (2008). Diffusion in brain extracellular space. *Physiological reviews* 88(4), 1277–1340.
- Takata, N., T. Mishima, C. Hisatsune, T. Nagai, E. Ebisui, K. Mikoshiba, and H. Hirase (2011). Astrocyte calcium signaling transforms cholinergic modulation to cortical plasticity *in vivo*. *The Journal of Neuroscience* 31(49), 18155–18165.
- Thomas, D., P. Lipp, S. Tovey, M. Berridge, W. Li, R. Tsien, and M. Bootman (2000). Microscopic properties of elementary Ca²⁺ release sites in non-excitabile cells. *Current Biology* 10(1), 8–15.
- Tian, G.-F., H. Azmi, T. Takahiro, Q. Xu, W. Peng, J. Lin, N. Oberheim, N. Lou, H. R. Zielke, and M. Nedergaard (2005). An astrocytic basis of epilepsy. *Nature Med.* 11(9), 973–981.

- Tian, G. F., T. Takano, J. H.-C. Lin, X. Wang, L. Bekar, and M. Nedergaard (2006). Imaging of cortical astrocytes using 2-photon laser scanning microscopy in the intact mouse brain. *Adv. Drug Delivery Rev.* 58(7), 773–787.
- Todd, K. J., H. Darabid, and R. Robitaille (2010). Perisynaptic glia discriminate patterns of motor nerve activity and influence plasticity at the neuromuscular junction. *J. Neurosci.* 30(35), 11870–11882.
- Torres, A., F. Wang, Q. Xu, T. Fujita, R. Dobrowolski, K. Willecke, T. Takano, and M. Nedergaard (2012). Extracellular Ca^{2+} acts as a mediator of communication from neurons to glia. *Science Signalling* 5(208), ra8.
- Troyer, T. and K. Miller (1997). Physiological gain leads to high ISI variability in a simple model of a cortical regular spiking cell. *Neural Computation* 9(5), 971–983.
- Ullian, E., K. Christopherson, and B. Barres (2004). Role for glia in synaptogenesis. *Glia* 47(3), 209–216.
- van den Pol, A. N., C. Romano, and P. Ghosh (1995). Metabotropic glutamate receptor mGluR5 subcellular distribution and developmental expression in hypothalamus. *J. Comp. Neurol.* 362, 134–150.
- Ventura, R. and K. M. Harris (1999). Three-dimensional relationships between hippocampal synapses and astrocytes. *J. Neurosci.* 19(16), 6897–6906.
- Verkhatsky, A., R. R. Rodriguez, and V. Parpura (2012). Calcium signalling in astroglia. *Mol. Cell Endocrinol.* 353(1-2), 45–56.
- Vogels, T. and L. Abbott (2009). Gating multiple signals through detailed balance of excitation and inhibition in spiking networks. *Nature Neuroscience* 12(4), 483–491.
- Volman, V., M. Bazhenov, and T. J. Sejnowski (2011). A computational model of neuronal and glial homeostatic synaptic plasticity in posttraumatic epileptogenesis. In *Neuroscience Meeting Planner*, Number 250.11/V5. Society for Neuroscience. Online.
- Volman, V., E. Ben-Jacob, and H. Levine (2007). The astrocyte as a gatekeeper of synaptic information transfer. *Neur. Comput.* 19, 303–326.
- Volterra, A. and J. Meldolesi (2005). Astrocytes, from brain glue to communication elements: the revolution continues. *Nature Rev. Neurosci.* 6(8), 626–640.

- Wang, X., N. Lou, Q. Xu, G.-F. Tian, W. G. Peng, X. Han, J. Kang, T. Takano, and M. Nedergaard (2006). Astrocytic Ca^{2+} signaling evoked by sensory stimulation *in vivo*. *Nature Neurosci.* 9(6), 816–823.
- Waters, J., M. Larkum, B. Sakmann, and F. Helmchen (2003). Supralinear Ca^{2+} influx into dendritic tufts of layer 2/3 neocortical pyramidal neurons *in vitro* and *in vivo*. *The Journal of Neuroscience* 23(24), 8558–8567.
- Watrás, J., I. Bezprozvanny, and B. E. Ehrlich (1991). Inositol 1,4,5-trisphosphate-gated channels in cerebellum: presence of multiple conductance states. *J. Neurosci.* 11(10), 3239–3245.
- Winship, I., N. Plaa, and T. Murphy (2007). Rapid astrocyte calcium signals correlate with neuronal activity and onset of the hemodynamic response *in vivo*. *The Journal of Neuroscience* 27(23), 6268–6272.
- Yang, Y., W. Ge, Y. Chen, Z. Zhang, W. Shen, C. Wu, M. Poo, and S. Duan (2003). Contribution of astrocytes to hippocampal long-term potentiation through release of d-serine. *Proceedings of the National Academy of Sciences* 100(25), 15194–15199.
- Zhang, B.-X., H. Zhao, and S. Muallem (1993). Calcium dependent kinase and phosphatase control inositol-1,4,5-trisphosphate-mediated calcium release: modification by agonist stimulation. *J. Biol. Chem.* 268(5), 10997–11001.
- Zhang, J.-M., H.-K. Wang, C.-Q. Ye, W. Ge, Y. Chen, Z.-L. Jiang, C.-P. Wu, M.-M. Poo, and S. Duan (2003). ATP released by astrocytes mediates glutamatergic activity-dependent heterosynaptic suppression. *Neuron* 40, 971–982.
- Zhang, Q., T. Pangršič, M. Kreft, M. Kržan, N. Li, J.-Y. Sul, M. Halassa, E. Van Bockstaele, R. Zorec, and P. G. Haydon (2004). Fusion-related release of glutamate from astrocytes. *J. Biol. Chem.* 279(13), 12724–12733.
- Zhang, Q., O. Pascual, G. Perea, A. Araque, M. Fukuda, and P. G. Haydon (2003). Expression of Synaptotagmin IV, V and XI in CA1 area hippocampal astrocytes. In *Prog. No. 765.3 2003 Abstract Viewer/Itinerary Planner*. Washington, DC: Soc. Neurosci. Online.
- Zhang, Y. and B. Barres (2010). Astrocyte heterogeneity: an underappreciated topic in neurobiology. *Current Opinion in Neurobiology* 20(5), 588–594.

- Zhang, Z., G. Chen, W. Zhou, A. Song, T. Xu, Q. Luo, W. Wang, X. Gu, and S. Duan (2007). Regulated ATP release from astrocytes through lysosome exocytosis. *Nature cell biology* 9(8), 945–953.
- Zonta, M. and G. Carmignoto (2002). Calcium oscillations encoding neuron-to-astrocyte communication. *J. Physiol. Paris* 96, 193–198.
- Zorec, R., A. Araque, G. Carmignoto, P. Haydon, A. Verkhratsky, and V. Parpura (2012). Astroglial excitability and gliotransmission: An appraisal of Ca²⁺ as a signaling route. *ASN Neuro* 4(2), e00080.
- Zucker, R. S. and W. G. Regehr (2002). Short-term synaptic plasticity. *Annual Rev. Physiol.* 64, 355–405.
- Zur Nieden, R. and J. W. Deitmer (2006). The role of metabotropic glutamate receptors for the generation of calcium oscillations in rat hippocampal astrocytes *in situ*. *Cerebral Cortex* 16, 676–687.

Figure Captions

Figure 1. The signaling network of astrocyte-synapse interactions. (A) A simplified scheme of the different signaling pathways between synaptic terminals and astrocytes for the case of excitatory synapses in the hippocampus (see text for a detailed description). Action potentials arriving at the presynaptic terminal trigger release of glutamate, which can spill over from the synaptic cleft. Perisynaptic astrocytes take up glutamate using their plasma membrane transporters (EAATs) while glutamate, by acting upon astrocytic metabotropic receptors (mGluRs), triggers Ca^{2+} signaling in the astrocyte. This signaling pathway includes production of IP_3 and causes an increase of cytosolic Ca^{2+} due to efflux of this ion from the endoplasmic reticulum (ER). At some synapses, such as in the dentate gyrus, the same Ca^{2+} signaling pathway could also be mediated by astrocytic purinergic P_2Y_1 receptors, likely activated by synaptically-released ATP (see text for details). Astrocytic Ca^{2+} excitability can in turn lead to exocytotic release of several neuroactive substances (or “gliotransmitters”) such as glutamate (Glu), D-serine (D-ser) or ATP which can target specific receptors on pre- and post-synaptic terminals and differentially modulate synaptic transmission. Glutamate acting on presynaptic GluRs could enhance synaptic release, whereas ATP and its derivate adenosine (Adn) could depress it (*red path*) through presynaptic purinergic receptors (PRs). On the postsynaptic spines (depicted here by a standard RC circuit (Ermentrout and Terman, 2010), the ensuing effect of gliotransmitters could substantially modify postsynaptic currents by enhancing activation of NMDA receptors (D-serine) or by altering expressions of AMPA receptors therein. Astrocytes could also release $\text{TNF}\alpha$ by Ca^{2+} -dependent activation of the matrix metalloprotease $\text{TNF}\alpha$ -converting enzyme (TACE), while extracellular $\text{TNF}\alpha$ could in turn regulate glutamate release from the astrocyte as well as postsynaptic AMPAR expression. Moreover astrocytic Ca^{2+} could also propagate across different regions of the same cell or to other neighboring astrocytes by intracellular IP_3 diffusion through gap junction channels (GJCs) or via extracellular ATP-dependent pathways, extending gliotransmission to some distal sites away from the considered synapse. For clarity both endocannabinoid-mediated Ca^{2+} signaling (Navarrete and Araque, 2008), retrograde activation of presynaptic glutamate receptors (Navarrete and

Araque, 2010), regulation of postsynaptic NMDARs by presynaptic adenosine receptors (Deng et al., 2011) and the possibility for astrocyte-derived adenosine to enhance synaptic release (Panatier et al., 2011) are not included in this scheme. **(B)** Equivalent modeling scheme for astrocyte-synapse interactions. The astrocyte (ASTRO) constitutes a third active element of the tripartite synapse in addition to the presynaptic (PRE) and postsynaptic (POST) terminals. In its presence, the flow of input (IN) signals to the output (OUT) is no more unidirectional but presynaptically released neurotransmitter can affect astrocyte function through the interaction pathway *A*. In turn, the astrocyte can regulate both synaptic terminals via pathways *B* and *C*. In addition, the astrocyte could receive additional inputs from or send output to remote synapses in a heterosynaptic fashion (I/O).

Figure 2. Computational aspects of astrocytic Ca^{2+} signaling. **(A)** Scheme of IP_3 -mediated Ca^{2+} -induced Ca^{2+} release in the astrocyte. Calcium and IP_3 signals are controlled by synaptic glutamate through metabotropic glutamate receptor- (mGluR-) $\text{PLC}\beta$ -mediated IP_3 production (see text for details). **(B)** IP_3 and Ca^{2+} signals can be envisioned to encode incoming synaptic activity through frequency and amplitude of their oscillations. Astrocytes could thus encode synaptic information either by the modulation of the amplitude (AM), the frequency (FM), or both (AFM) of their Ca^{2+} oscillations. **(C)** Simulated Ca^{2+} and IP_3 patterns in response to sample synaptic glutamate release (Glu) in a model astrocyte (De Pittà et al., 2009) reveals that IP_3 signals could be locked in the AFM-encoding independently of the encoding mode of the associated Ca^{2+} signals. This feature could allow the astrocyte to optimally integrate synaptic stimuli. **(D, top)** Simulated Ca^{2+} (*black trace*) and IP_3 (*green trace*) signals in the same astrocyte model as in **(C)**, and associated rates of IP_3 production (prod.) and degradation (degr.) (*middle panels, dashed black lines*) in response to two consecutive synaptic glutamate release events (*bottom panel, Glu*). The analysis of the contributions of different enzymes to IP_3 signaling (*solid colored traces; cyan: $\text{PLC}\beta$; pink: $\text{PLC}\delta$; orange: IP-5P ; purple: $\text{IP}_3\text{-3K}$*) reveals dynamical regulation by Ca^{2+} of different mechanisms of IP_3 production/degradation which could ultimately underlie dynamical regulation of astrocyte processing of synaptic stimuli. **(E)** Simulated propagation of Ca^{2+}

waves in a heterogeneous linear chain composed of both FM (*red traces*) and AFM (*blue traces*) astrocytes reveals that encoding of synaptic activity (STIMULUS) could change according to cell location along the chain. Adapted from (Goldberg et al., 2010).

Figure 3. Linking gliotransmitter exocytosis to various Ca^{2+} encoding modes. (A) Calcium-dependent glutamate and ATP exocytosis from astrocytes are both brought forth by a vesicular compartment in the astrocyte competent for regulated exocytosis. The frequency of exocytotic events is directly controlled by the shape and frequency of Ca^{2+} oscillations. (B) Modeling concept for an “exocytosis event” from the astrocyte. Calcium (*top trace*) triggers exocytosis of glutamate or ATP every time it increases beyond a certain threshold concentration value (*red dashed line*). The overall release can then be approximated, under proper assumptions, by an exponentially-decaying pulse of extracellular concentration of glutamate or ATP (*bottom trace*). (C) Distinct Ca^{2+} encoding patterns could translate into distinct rates of gliotransmitter exocytosis events. The synaptic activity encoded by astrocytic Ca^{2+} signals is linked to the frequency of glutamate/ATP release from the astrocyte in a unique fashion. Adapted from (De Pittà et al., 2011).

Figure 4. Glutamate or ATP released from astrocytes regulates transitions between facilitation and depression of synaptic transmission. (A) Conceptual framework for the regulation of synaptic release probability at basal conditions by astrocytes. Astrocyte-released glutamate increases the basal synaptic release probability (U_0), whereas astrocyte-released ATP/Adn generally decreases it. (B) Changes in synaptic release probability due to astrocytic gliotransmitters can be detected by variations of paired-pulse plasticity quantified by paired-pulse ratio (PPR). Paired-pulse facilitation (*left, green traces*) of postsynaptic currents (PSCs) corresponds to PPR values above 1 (*right, green-shaded area*) whereas paired-pulse depression (*top, magenta traces*) are associated with PPR values below 1 (*right, magenta-shaded area*). (C) Raster plots of simulated PSC pairs for 100 different input spike trains with same statistics colored according to the paired-pulse ratio: *green* for facilitation, $\text{PPR} > 1$; *magenta* for depression, $\text{PPR} < 1$. For increasing rates of exocytosis of gliotransmitter from the

astrocyte, mimicked by increasing rates of Ca^{2+} crossing beyond the threshold for exocytosis (*top row, red dashed line*), synaptic plasticity could be progressively changed to its opposite depending on the type of gliotransmitter. Astrocytic glutamate could thus turn facilitating synapses into depressing (*middle row*) whereas astrocyte-derived ATP or adenosine could turn depressing synapses into facilitating (*bottom row*). Simulations are based on a model of astrocyte-regulation of synaptic release introduced in (De Pittà et al., 2011). ‘Basal Synaptic Release Probability’ in **(B)** refers to the probability of synaptic release at rest, that is when synaptic activity is assumed to be very low and the amount of neurotransmitter released upon arrival of an action potential to the presynaptic terminal is essentially independent of previous release events (De Pittà et al., 2011; Zucker and Regehr, 2002).

Figure 5. Short-term synaptic plasticity is physiologically set by the rate of gliotransmitter release from the astrocyte. **(A)** The rate of glutamate or ATP release from the astrocyte could differently affect basal synaptic release probability. In particular, a threshold frequency for the release of these gliotransmitters could exist (*blue vertical line*) beyond which a depressing synapse could turn into facilitating (*right, green area*) or vice versa, a facilitating synapse could become depressing (*left, magenta area*). Adapted from (De Pittà et al., 2011). **(B)** In basal conditions, synaptic release is due to sporadic neuronal network firing and the possible frequency of Ca^{2+} fluctuations beyond the threshold for exocytosis (*dashed red line*) in the astrocyte (*top trace*). In this fashion plastic changes in paired-pulse ratio could be inherently regulated by astrocytic gliotransmitters, as shown here for the case of an originally facilitating synapse under the effect of astrocytic glutamate exocytosis (20 trials with identical input statistics). Adapted from (Berry et al., 2011). The color code for the raster plot is the same as in Figure 4C.

Table 1. Transmitters targeting receptors have major effects on synaptic transmission through the signaling pathways A, B, C in Figure 1B based on *in situ* and *in vivo* studies. Reference to *in vitro* studies is included whenever the latter are missing. Legend:

1. Specimen. **F:** frog; **H:** human; **M:** mouse; **R:** rat. **2.** Preparation. **VT:** *in vitro*/cultures; **ST:** *in situ*/slices; **VV:** *in vivo*. **3.** Brain area or body area. **BC:** barrel cortex; **CA1:** Cornu Ammonis area 1; **CER:** cerebellum; **COR:** cortex, **DH:** dorsal horn; **HIP:** hippocampus; **MLDG:** molecular layer dentate gyrus; **NAcc:** nucleus accumbens; **NMJ:** neuromuscular junction; **PVN:** paraventricular nucleus of the hypothalamus; **Ret:** retina; **VBT:** ventrobasal thalamus; **V1:** primary visual cortex; **VC:** visual cortex.

4. Synaptically-released neurotransmitter. **ACh:** acetylcholine; **ECB:** endocannabinoids; **NE:** norepinephrine. **5.** Astrocytic receptors targeted by synaptically-released neurotransmitters (pathway A) and neuronal receptors targeted by gliotransmitters (pathways B, C). **α AR (α_1 AR):** α - (α_1 -) adrenergic receptors; **CBR:** cannabinoid receptors; **iGluR:** ionotropic glutamate receptors; **KAR:** kainate receptor; **mAChR:** muscarinic receptors; **mGluR-I, mGluR-II/III:** group I (II/III) metabotropic glutamate receptors. **6.** Gliotransmitter released from astrocyte. **7.** Cell targeted by gliotransmission, where targeted receptors and effects were reported. **AC:** amacrine cell; **CN:** cortical neuron; **GC:** granule cell; **IN:** interneuron; **MF:** muscle fiber; **PF:** parallel fiber axon; **PY:** pyramidal neuron; **MNC:** magnocellular neurosecretory cell; **MSN:** medium spiny neurons; **SGN:** substantia gelatinosa neuron; **RN:** retinal neuron. **V1N:** V1 excitatory neuron; **8.** Effects triggered by gliotransmission on pathways B or C in Figure 1B. **(f)EPSP:** (field) excitatory postsynaptic potential; **mEPSC (mIPSC):** miniature excitatory (inhibitory) postsynaptic current; **t-LTP (t-LTD):** spike-timing dependent long-term potentiation (depression); **LTP:** long-term potentiation; **PTD:** post-tetanic depression; **PTP:** post-tetanic potentiation; **SICs:** slow inward (depolarizing) currents; **SOCs:** slow outward (hyperpolarizing) currents. Arrows denote increase (\uparrow) or decrease (\downarrow) and are followed by the associated signal, i.e. $\uparrow(\downarrow)$ **EPSP (frequency)(amplitude)(slope):** increase (decrease) in (frequency)(amplitude) (slope) of EPSPs. **fEPSP,** filed EPSP. **Other:** **b:** study on Bergmann glia cells; **r:** retrograde signaling; **s:** suggested by investigators; **m:** study on Müller glia cells; **n.r.:** when existence of a specific signaling pathway is observed but details are *not reported*; *****: indirect evidence.

| Reference | Sp. ¹ | Prep. ² | Area ³ | Syn. Neurotr. ⁴ | Targeted Receptor ⁵ | Gliotr. ⁶ | Targeted Receptors ⁵ | | Cell ⁷ | Effects ⁸ |
|------------------------------|------------------|--------------------|-------------------|----------------------------|--|----------------------|-------------------------------------|---------------------------------|-------------------|--|
| | | | | | Pathway A | | Pathway B | Pathway C | | |
| (Wang et al., 2006) | M | VV | BC | Glu | mGluR-I | | | | | |
| (Porter and McCarthy, 1996) | R | ST | CA1 | Glu | mGluR, iGluR | | | | | |
| (Perea and Araque, 2007) | R | ST | CA1 | | | Glu | mGluR-I | | PY | ↑synaptic release probability |
| (Liu et al., 2004) | R | ST | CA1 | | | Glu | KAR | | IN | ↑mIPSCs (frequency) |
| (Liu et al., 2004) | R | ST | HIP | | | Glu | mGluR-II/III | | IN | ↓synaptic release probability |
| (Bardoni et al., 2010) | R | ST | DH | | | Glu | | NMDAR | SGN | SICs; synchronous Ca ²⁺ elevations in neighboring neurons |
| (Kang et al., 2005) | R | ST | CA1 | | | Glu | | iGluR | PY | SICs |
| (Parri et al., 2001) | R | ST | VBT | | | Glu | | NMDAR | TCN | SICs |
| (Bezzi et al., 1998) | R | ST,VT | CA1,VC, COR | | | Glu | | GluR | PY | Ca ²⁺ elevations in neighboring neurons |
| (Newman and Zahs, 1997) | R | ST | Ret ^m | | | Glu* | | iGluR | AC* | ↑neuronal inhibition |
| (Bonansco et al., 2011) | R | ST | CA1 | | | Glu | mGluR-I | NMDAR | PY | ↑mEPSCs (frequency); SICs; control of t-LTP induction |
| (Fiacco and McCarthy, 2004) | M | ST | CA1 | n.r. | n.r. | Glu | mGluR-I | | PY | ↑synaptic release probability |
| (Pasti et al., 1997) | R | ST | CA1, VC | Glu | mGluR | Glu* | | | PY | Ca ²⁺ elevations in neighboring neurons |
| (Pirttimaki et al., 2011) | R | ST | VBT | n.r. | mGluR-I | Glu | | NR ₂ B-NMDAR | TCN | Long-term enhancement of SIC frequency |
| (D'Ascenzo et al., 2007) | M | ST | NAcc | Glu | mGluR ₅ | Glu | | NR ₂ B-NMDAR | MSN | SICs, ↑neuronal firing |
| (Fellin et al., 2004) | R | ST | CA1 | Glu | n.r. | Glu | | NR ₂ B-NMDAR | PY | SICs; synchronous Ca ²⁺ elevations in neighboring neurons |
| (Newman, 2005) | R | ST | Ret ^m | ATP | n.r. | | | | | |
| (Piet and Jahr, 2007) | R | ST | CER ^b | Glu, ATP | AMPA, P ₂ YR | | | | | |
| (Rieger et al., 2007) | M | ST | OB | Glu, ATP | mGluR ₁ , P ₂ Y ₁ R | | | | | |
| (Beierlein and Regehr, 2006) | R | ST | CER ^b | Glu, ATP | mGluR ₁ , P ₂ YR | | | | | |
| (Newman, 2003) | R | ST | Ret ^m | | | ATP | | A ₁ R | RN | ↑K ⁺ conductance; ↑neuronal inhibition |
| (Torres et al., 2012) | M | ST | CA1 | | | ATP | | P ₂ Y ₁ R | IN | ↑neuronal firing |
| (Schmitt et al., 2012) | M | ST,V V | HIP | n.r. | n.r. | ATP | A ₁ R | | PY | ↓fEPSP (slope) |
| (Di Castro et al., 2011) | R | ST | MLDG | ATP | P ₂ Y ₁ R | n.r. | n.r. | | GC | ↑synaptic release probability |
| (Halassa et al., 2009) | M | VV | COR | n.r. | n.r. | ATP | A ₁ R | | CN | ↓fEPSP (slope) |
| (Jourdain et al., 2007) | R | ST | MLDG | ATP* | P ₂ Y ₁ R | Glu | NR ₂ B-NMDARs | | GC | ↑synaptic release probability |
| (Panatier et al., 2011) | R | ST | CA1 | Glu | mGluR ₅ | ATP | A _{2A} R | | PY | ↑synaptic release probability |
| (Schipke et al., 2008) | M | ST | BC | Glu | mGluR-I | ATP | A ₁ R, P ₂ YR | | PY | ↑neuronal inhibition; confinement of astrocytic Ca ²⁺ signals |
| (Pascual et al., 2005) | M | VT,ST | CA1 | Glu | n.r. | ATP | A ₁ R | | PY | ↓fEPSP (slope); heterosynaptic depression; control of long-term |

| | | | | | | | | | | | |
|--------------------------------|---|-----------|------------------|------------------|---|--------------|-------------------------------------|--|----------------------------------|---------------------|--|
| | | | | | | | | | | | plasticity (metaplasticity) |
| (Zhang et al., 2003) | R | ST,VT | CA1 | Glu | n.r. | ATP | A ₁ R, P ₂ YR | | | PY | ↓EPSP (amplitude); heterosynaptic depression |
| (Todd et al., 2010) | F | VT | NMJ | n.r. | n.r. | ATP | A ₁ R, A _{2A} R | | | MF | PTD (A ₁ R); PTP (A _{2A} R) |
| (Robitaille, 1998) | F | VT | NMJ | | | n.r. | n.r. | | | MF | PTP; PTD |
| (Bowser and Khakh, 2004) | M | ST | CA1 | ATP, Glu | P ₂ Y ₁ R, mGluR-I | ATP | | | P ₂ Y ₁ R | IN | SICs, ↑neuronal firing |
| (Gordon et al., 2009) | R | ST | PVN | Glu | mGluR-I | ATP | | | P ₂ XR | MNC | ↑mEPSCs (amplitude) |
| (Araque et al., 2002) | R | ST | CA1 | ACh | mAChR | | | | | | |
| (Bélair et al., 2010) | F | VV | NMJ | ACh, ATP | mAChR, P ₂ YR, P ₂ XR | | | | | | |
| (Navarrete et al., 2012) | R | ST,V V | CA1 | ACh | mAChR | Glu | mGluR | | | PY | ↑synaptic release probability; LTP |
| (Chen et al., 2012) | M | VV,S T | V1 | ACh | mAChR | n.r. | | | NMDAR | V1N | SICs, ↑neuronal firing |
| (Perea and Araque, 2005) | R | ST | CA1 | ACh, Glu | mAChR, mGluR | Glu | | | NMDAR | PY | SICs |
| (Bekar et al., 2008) | M | VV | COR | NE | αAR | | | | | | |
| (Kulik et al., 1999) | M | ST | CER ^b | NE | α ₁ AR | | | | | | |
| (Gordon et al., 2005) | R | VT,ST | PVN | NE | α ₁ AR | ATP | | | P ₂ X ₇ R | MNC | ↑mEPSCs (amplitude) |
| (Min and Nevian, 2012) | R | ST | BC | ECB ^f | CB ₁ R | Glu | NMDAR | | | PY | ↓EPSP (slope), t-LTD |
| (Navarrete and Araque, 2010) | M | ST | CA1 | ECB ^f | CB ₁ R | Glu | mGluR | | | PY | ↑synaptic release probability |
| (Navarrete et al., 2012) | H | ST | HIP, COR | n.r. | GluR, PR, CBR | Glu | | | NMDAR | PY | SICs |
| (Navarrete and Araque, 2008) | M | ST | CA1 | ECB ^f | CB ₁ R | Glu | | | NMDAR | PY | SICs |
| (Panatier et al., 2006) | R | ST | SON | | | d-ser | | | NMDAR | MNC | Control of long-term plasticity (metaplasticity) |
| (Takata et al., 2011) | M | VV | BC | ACh | mAChR | d-ser | | | NMDAR | PY | Control of LTP induction |
| (Henneberger et al., 2010) | R | ST | CA1 | n.r. | n.r. | d-ser | | | NMDAR | PY | Control of LTP induction |
| (Fellin et al., 2009) | M | VV,S T | COR,HI P | n.r. | n.r. | d-ser | | | NMDAR | CN,PY | ↑NMDAR-mediated currents |
| (Yang et al., 2003) | R | ST,VT | CA1 | Glu | n.r. | d-ser | | | NMDAR | PY | Control of LTP induction |
| (Lee et al., 2011) | H | VT | COR | | | GABA | | | | | |
| (Le Meur et al., 2012) | R | ST | HIP | | | GABA, Glu | | | GABA _A R, NMDAR | PY | SOCs (GABA _A R); SICs (NMDAR) |
| (Lee et al., 2010) | M | ST | CER ^b | | | GABA | | | GABA _A R ^s | GC, PF ^s | ↑neuronal inhibition ^s |
| (Kozlov et al., 2006) | R | ST | OB | | | GABA, Glu | | | GABA _A R, NMDAR | MC | SOCs (GABA _A R); SICs (NMDAR) |
| (Serrano et al., 2006) | R | ST | CA1 | GABA | GABA _B R | ATP | A ₁ R | | | PY | ↓fEPSP (amplitude); heterosynaptic depression |
| (Kang et al., 1998) | R | ST | CA1 | GABA | GABA _B R | n.r. | iGluR | | iGluR | PY | ↑mIPSCs (frequency and amplitude) |
| (Stellwagen and Malenka, 2006) | M | VT | HIP | | | TNFα | | | n.r. | PY | ↑AMPA; LTP |
| (Beattie et al., 2002) | R | ST,VT | HIP | | | TNFα | | | n.r. | PY | ↑AMPA |
| (Santello et al., 2011) | M | ST,VT | MLDG | | | TNFα, | | | | | Control of Glu exocytosis from |

| | | | | | | | | | | |
|----------------------|-----|-------|-----|--|--|-----------------------|--|--|--|--|
| | | | | | | Glu | | | | astrocytes |
| (Bezzi et al., 2001) | R,H | ST,VT | HIP | | | TNF α , Glu | | | | Control of Glu exocytosis from astrocytes |

Table 2. Comparison of time scales for rising and decaying phase and full-width half-maximum (FWHM) duration of intracellular Ca^{2+} , and extracellular glutamate (Glu) and ATP changes in astrocytes and in neurons. Glutamate and ATP values refer to transient increases of their extracellular concentrations following release in a Ca^{2+} dependent fashion. Therefore they describe the time course of the *overall* glutamate and ATP released by an exocytotic burst rather than by a single exocytotic event which can be much faster and occur within the first ~ 50 ms from Ca^{2+} rise (see text). Indicative rise and decay time constants as well as FWHM values are reported in terms of min-max ranges. Fast calcium signals imaging in astrocyte in the somatosensory cortex reported by (Winship et al., 2007) are reported separately and dubbed by ‘a’. The letter ‘f’ stands for values that were obtained by fitting of experimental data by a biexponential function such as $f(t) = C \cdot (\exp(-t/\tau_{\text{decay}}) - \exp(-t/\tau_{\text{rise}}))$ with C being a proper scaling factor. Asterisk ‘*’ denotes values estimated by a model of astrocytic and synaptic release introduced in (De Pittà et al., 2011).

| Signal | Origin | τ_{rise} [s] | τ_{decay} [s] | FWHM [s] | Essential Reference |
|------------------|-------------------------------|--------------------------|---------------------------|------------------|--|
| Ca^{2+} | Astrocyte (soma) | $2 - 20^f$ | $3 - 25^f$ | 5 – 160 | (Wang et al., 2006; Hirase et al., 2004; Nimmerjahn et al., 2004) |
| | Astrocyte (soma) ^a | ~ 0.5 | ~ 1.1 | $\sim 2 - 4$ | (Winship et al., 2007) |
| | Neuron (soma) | $2 - 5 \cdot 10^{-3}$ | 0.1 – 0.4 | $\sim 0.1 - 0.3$ | (Nimmerjahn et al., 2004; Waters et al., 2003; Svoboda et al., 1997) |
| | Astrocyte (process) | 0.1 – 0.2 | $0.2 - 4^f$ | $\sim 0.5 - 4$ | (Di Castro et al., 2011; Panatier et al., 2011) |
| | Neuron (presynaptic bouton) | $0.5 - 5 \cdot 10^{-3}$ | $\sim 0.1 - 2$ | 0.1 – 1* | (Emptage et al., 2001; Regehr et al., 1994) |
| Glu | Astrocyte | 0.2 – 0.5 | 0.5 – 1.5 | 1 – 6 | (Santello et al., 2011; Marchaland et al., 2008; Domercq et al., 2006) |
| | Neuron (synapse) | $1 - 5 \cdot 10^{-4}$ | 0.01 – 0.1 | 0.01 – 0.1* | (Okubo et al., 2010; Herman and Jahr, 2007; Raghavachari and Lisman, 2004) |
| ATP | Astrocyte | 0.1 – 0.5 | 2 – 3 | 2 – 20 | (Pangršic et al., 2007; Li et al., 2008) |
| | Neuron (synapse) | $1 - 5 \cdot 10^{-4*}$ | $0.2 - 1^*$ | 0.15 – 0.5 | (Pankratov et al., 2007; Dundwiddie and Masino, 2001) |

Figure 1.TIF

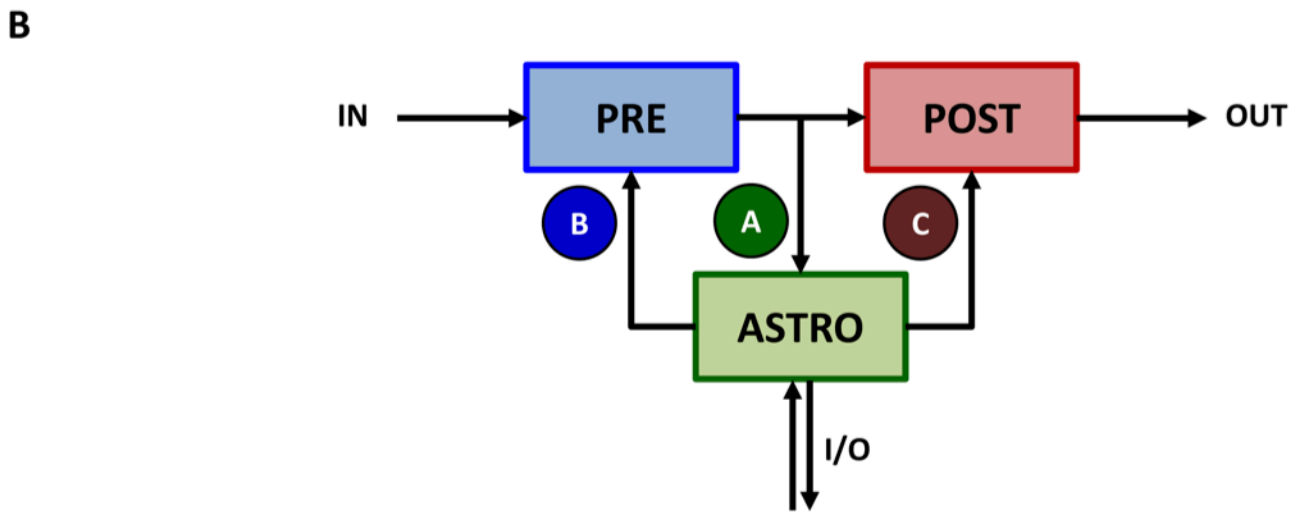
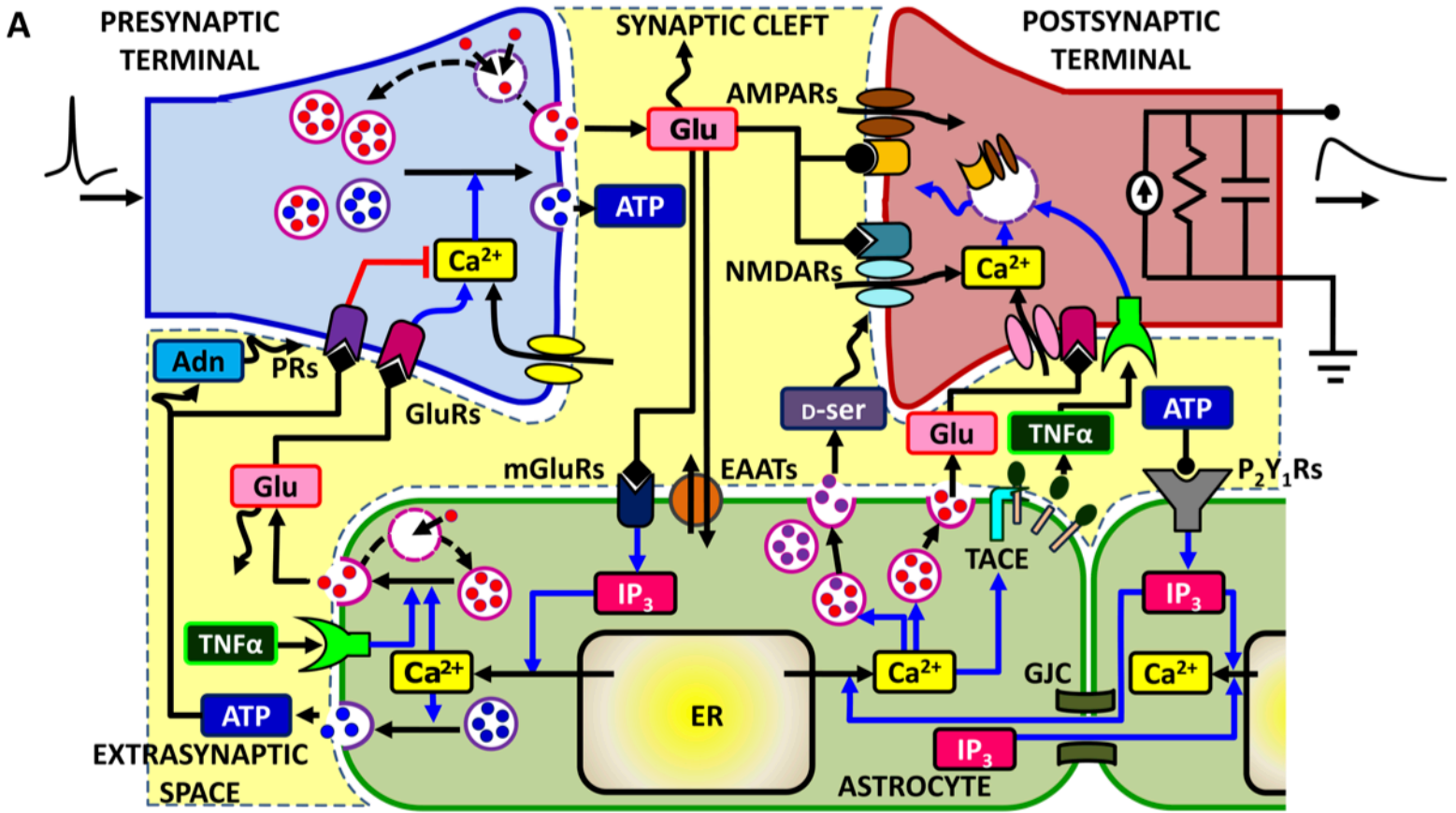

Figure 2.TIF

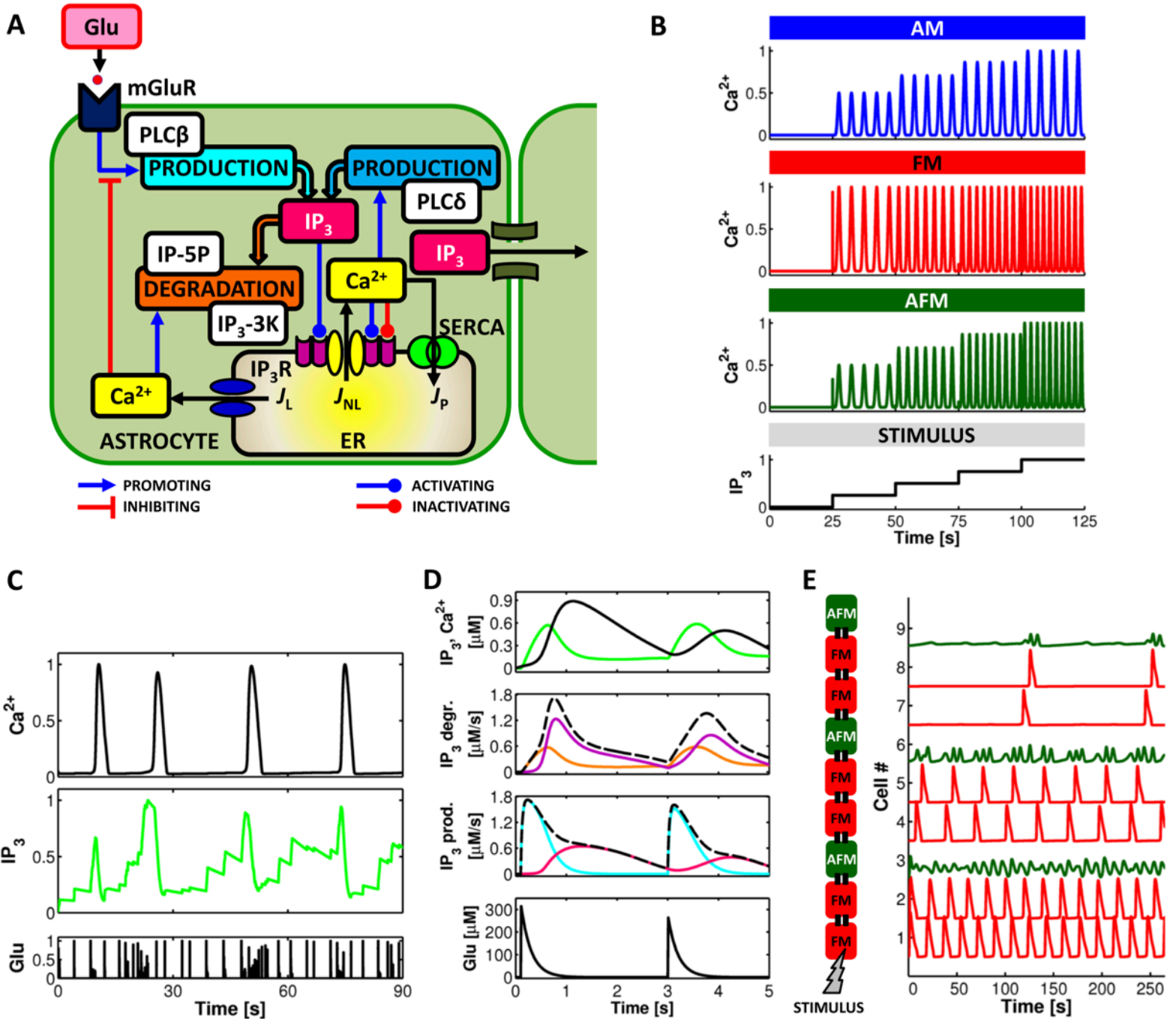

Figure 3.TIF

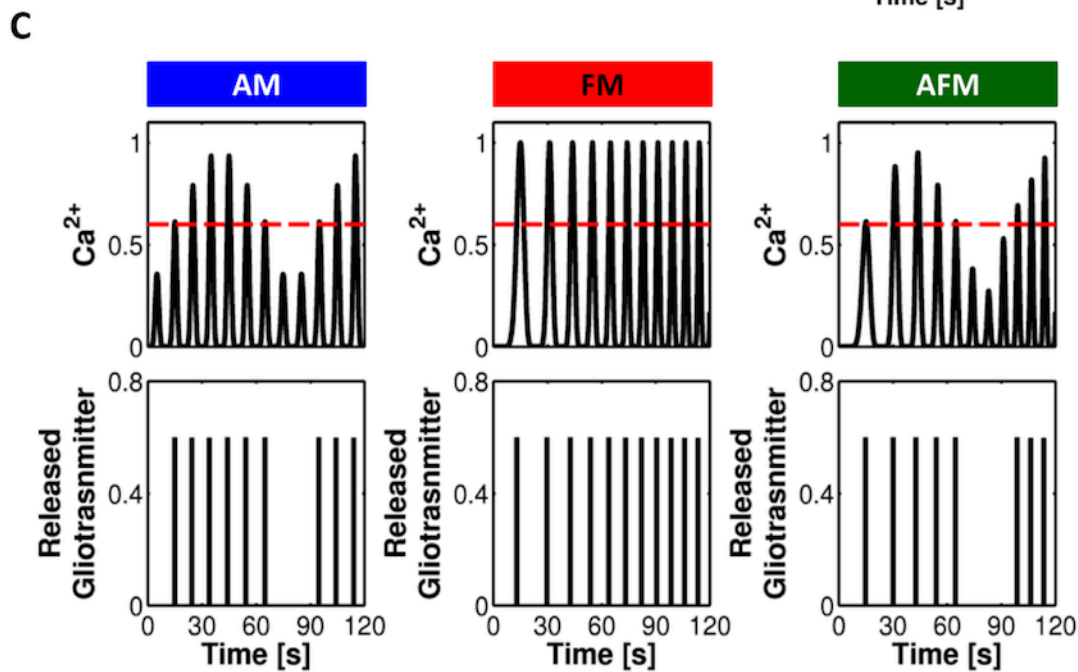
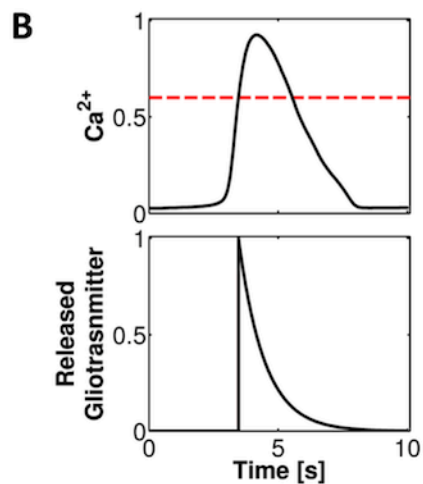
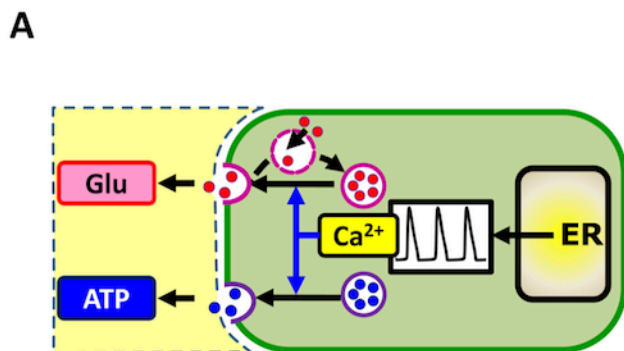

Figure 4.TIF

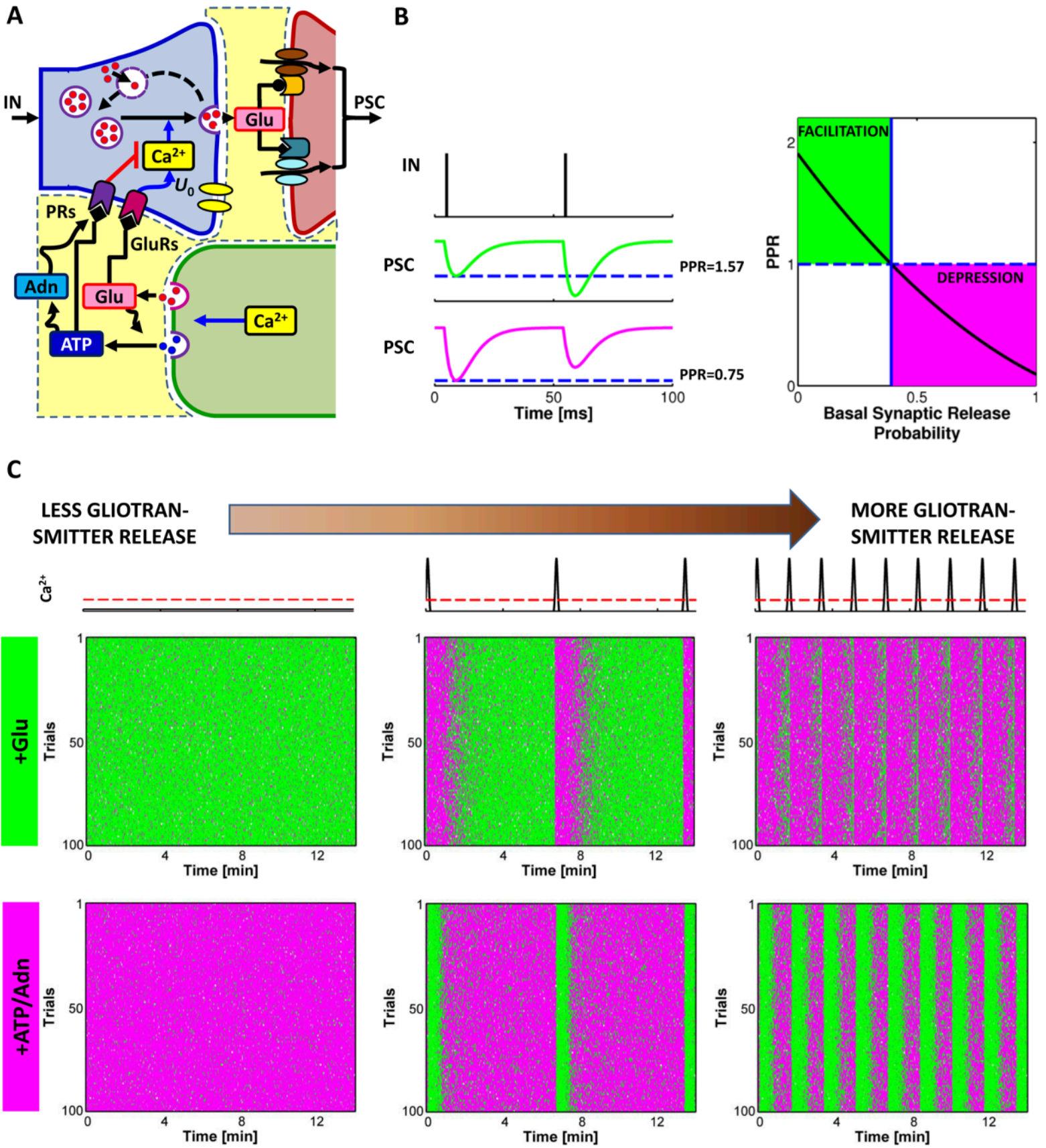
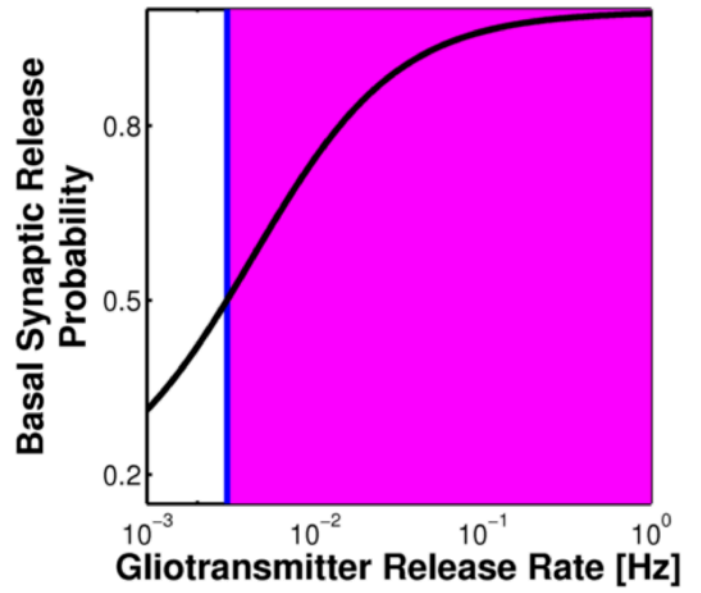
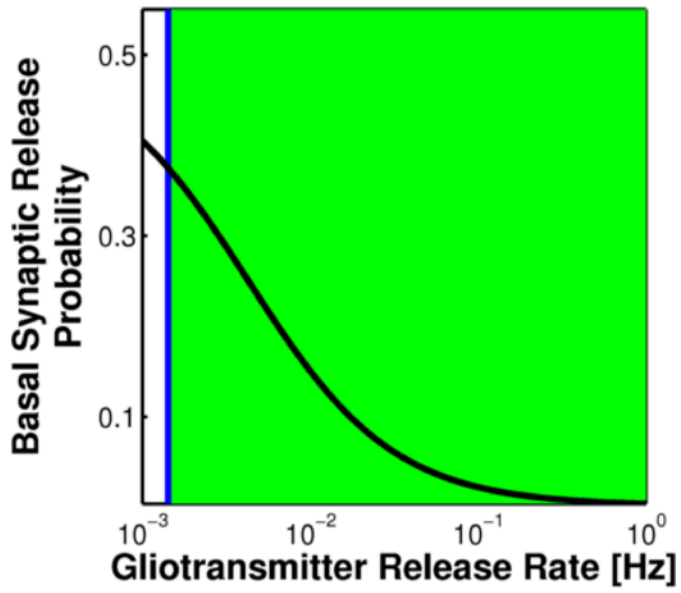

Figure 5.TIF

A



B

