



HAL
open science

Association Control for Wireless LANs: Pursuing Throughput Maximization and Energy Efficiency

Oyunchimeg Shagdar, Suhua Tang, Akio Hasegawa, Tatsuo Shibata,
Masayoshi Ohashi, Sadao Obana

► **To cite this version:**

Oyunchimeg Shagdar, Suhua Tang, Akio Hasegawa, Tatsuo Shibata, Masayoshi Ohashi, et al.. Association Control for Wireless LANs: Pursuing Throughput Maximization and Energy Efficiency. International Journal On Advances in Networks and Services, 2012, 5 (3&4). hal-00760584v2

HAL Id: hal-00760584

<https://inria.hal.science/hal-00760584v2>

Submitted on 22 Dec 2012

HAL is a multi-disciplinary open access archive for the deposit and dissemination of scientific research documents, whether they are published or not. The documents may come from teaching and research institutions in France or abroad, or from public or private research centers.

L'archive ouverte pluridisciplinaire **HAL**, est destinée au dépôt et à la diffusion de documents scientifiques de niveau recherche, publiés ou non, émanant des établissements d'enseignement et de recherche français ou étrangers, des laboratoires publics ou privés.

Association Control for Wireless LANs: Pursuing Throughput Maximization and Energy Efficiency

Oyunchimeg Shagdar*, Suhua Tang[†], Akio Hasegawa[†], Tatsuo Shibata[†], Masayoshi Ohashi[†], and Sadao Obana[‡]
Email: oyunchimeg.shagdar@inria.fr, {shtang, ahase, shibata, ohashi}@atr.jp, and obana@cs.uec.ac.jp

* IMARA Project-Team, INRIA Rocquencourt

Domaine de Voluceau, B.P. 105 78153, Le Chesnay, FRANCE

[†] ATR Adaptive Communications Research Laboratories

Hikaridai, Keihanna Science City, Kyoto, JAPAN

[‡] Graduate School of Informatics and Engineering, University of Electro-Communications

1-5-1 Chofugaoka, Chofu, Tokyo, JAPAN

Abstract—Because the access points (APs) and the stations (STAs) of a community access network are deployed at the users' desired places, the APs and STAs tend to concentrate in certain areas. A concentration of STAs often results in the AP(s) and STAs in that particular area suffering from severe congestion. A concentration of APs, on the other hand, may cause energy wastage. While a number of association control schemes are proposed to alleviate congestion in WLANs, the existing schemes do not necessarily maximize throughput and do not consider energy consumption. In this paper, we analytically formulate the network throughput as the multiplication of the success probability, frame transmission rate, and channel air-time ratio. The second and third components can easily be monitored and controlled based on measurements of local link and channel condition using the off-the-shelf WLAN devices. On the other hand, the first component, success probability is a function of the number of contending nodes that is extremely difficult to monitor in overlapping WLANs. Due to this reason, we extend our theoretical study and show that success probability can be indirectly maximized by controlling air-time ratio. Finally, we propose an association control scheme that aims at maximizing throughput and reducing energy consumption by taking account of the multiplication of frame transmission rate and air-time ratio. The proposed scheme is evaluated by computer simulations and testbed experiments conducted under real-world complex scenarios with UDP and TCP traffic. Both the simulations and actual implementations confirm the correctness of the theoretical work and the effectiveness of the proposed scheme.

Index Terms—association control; throughput maximization; success probability; air-time ratio; congestion alleviation; energy efficiency

I. INTRODUCTION

Due to the increasing popularity of WLAN technology, users (i.e., STAs) are often in the vicinity of one or more APs deployed at offices, school campuses, hotspot areas (e.g., cafes, train stations, airports), and individuals' homes. Such a widespread deployment of WLAN triggered a launch of community access networks, including FON [2], which are built exploiting user-owned APs. As community access networks enable users to enjoy ubiquitous Internet access, it has the potential to play an important role in the future networking paradigm.

The APs of a community access network are deployed at the users' desired places. Therefore, the fundamental difference

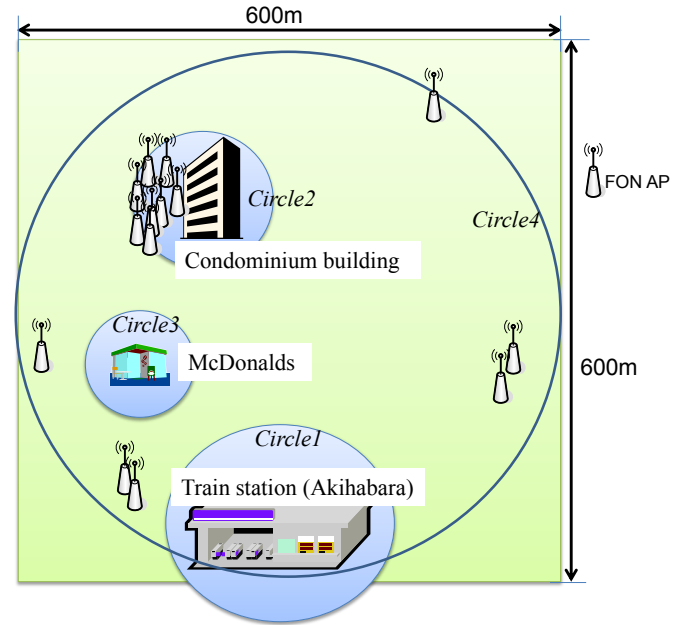

Figure 1. A map showing locations of FON APs in 600m×600m area in Tokyo. 8 out of the total 16 APs are concentrated in a small area (1/8 of the overall area). (The information is taken from maps.fon.com on July 20, 2010)

of community networks from, e.g., enterprise wireless access networks is that a systematic placement of the APs is not possible. In community networks, APs are often concentrated in areas such as a residential street, and their distribution is highly non-uniform. Fig. 1 shows a FON map for an approximately 600m×600m area in Tokyo (near Akihabara station). Out of the total 14 APs installed in the overall area, 8 APs are concentrated in a small area in the upper left part of the map (approximately 1/8 of the overall area). The majority of these APs are in fact deployed in a condominium building, where residential homes, a café, conference spaces, and a fitness centre are. The remaining 6 APs are distributed in the rest 7/8 of the overall area as shown in the figure. STAs (i.e., users) are, on the other hand, expected to be concentrated in public places, such as cafés and train stations. Therefore, it is clear that STAs and APs are not necessarily concentrated

in a same area. A concentration of STAs often results in the AP(s) and STAs in that particular area suffering from severe congestion [3]-[4]. A concentration of APs, on the other hand, may cause energy wastage [5].

Congestion can be effectively alleviated by a proper association control. Indeed, a number of association control schemes are proposed for WLANs, mainly aiming at load balancing among cells under different definitions of load (e.g., load is defined as the number of nodes in [3], [6], channel condition in [7], and traffic rate in [8], [4]).

In [1], we analytically formulated the throughput maximization problem for overlapping WLANs, and showed that the existing schemes do not necessarily operate towards throughput maximization. The throughput can be expressed as the multiplication of three components: success probability, frame transmission rate, and air-time ratio (ATR). The success probability is the probability of collision-free transmission and it is a function of the number of contending nodes. The frame transmission rate is the speed of the data transmission, and it is a function of the link quality. ATR is the ratio of the channel busy time to the total time. While link quality and ATR can easily be monitored in WLAN systems, counting the number of contending nodes is extremely difficult because the nodes can be beyond the transmission range of each other. Thus in [1], we proposed an association control scheme that aims at throughput maximization by maximizing the multiplication of frame transmission rate and ATR. Success probability is indirectly maximized by controlling ATR. Moreover, because the existing association control schemes aim at load balancing among cells, they tend to use all the existing APs. However, especially in AP-concentrated areas, throughput maximization can be achieved by utilizing fewer APs. Such an association control provides a positive impact on energy efficiency since the unused APs can be in the power-saving mode. Indeed the proposed scheme does not aim at load balancing and it can reduce the number of active APs without hampering the network throughput.

This paper extends our work by a detailed theoretical study and extensive performance investigations. More specifically, the contributions of this paper are:

- An analytical study that explains why and how the success probability can be maximized by controlling air-time ratio.
- An extensive investigation of the proposed scheme through testbed evaluations targeting UDP and TCP traffic in complex real-world scenarios.

The remainder of the paper is organized as follows. Section II formulates the throughput maximization problem and introduces the related works. In section III, we provide a theoretical study on ATR and its relation with success probability. Section IV introduces the proposed association control scheme that aims at maximizing network throughput and reducing energy consumption. Sections V and VI evaluate the proposed scheme through computer simulations and testbed experiments. Finally, we conclude the paper in section VII.

II. PROBLEM FORMULATION AND RELATED WORK

The throughput of a node in a WLAN operating under DCF (Distributed Coordination Function) is expressed as follows [9], [10].

$$s = \frac{P_s P_{tr} E[P]}{(1 - P_{tr})\sigma + P_{tr}T} \quad (1)$$

Here, $E[P]$ is the average data size, P_{tr} is the probability that there is at least one node transmitting in the sensing range of the node, and P_s is the probability of a successful transmission. σ is the slot time and T is the average time required for transmission of a data (includes DIFS and etc.). The numerator of (1) corresponds to the successfully transmitted payload length and the denominator is the total time. The former and the latter components of the denominator are the time that channel is idle and busy (either due to successful or unsuccessful transmissions), respectively.

The transmission of a data is successful if the frame is not collided and the frame does not contain errors (due to poor link quality). Thus, letting P_{sc} and P_{se} represent the probabilities of the former and the latter events, respectively, $P_s = P_{sc} \times P_{se}$. P_{sc} (in what follows we call P_{sc} as success probability) is expressed as

$$P_{sc} = \frac{\tau(1 - \tau)^{n-1}}{1 - (1 - \tau)^n} \quad (2)$$

where n is the number of nodes. τ is the channel access probability, which is determined by the contention window size (CW) and the probability that a node has a frame to transmit [10].

Letting $r \equiv P_{se} \times E[P]/T$, we rewrite (1) as

$$s = P_{sc} \times r \times \frac{P_{tr}T}{(1 - P_{tr})\sigma + P_{tr}T} \quad (3)$$

$E[P]/T$, the average frame transmission rate, is variable if rate adaptation is deployed at MAC (Medium Access Control protocol), and it is fixed otherwise. If rate adaptation is deployed, the better the link quality (stronger RSSI), the higher is the selected transmission rate. Furthermore, if the rate adaption operates such that packet error rate (PER) is minimized (i.e., P_{se} is maximized), the second component of (3), r , depends mainly on the selected transmission rate, i.e., $r \approx E[P]/T$. The last component of (3) is the ratio of time the channel is determined to be busy to the total time. Letting ATR (air-time ratio) represent the last component, the throughput of a node is the multiplication of P_{sc} , r , and ATR.

Finally, the throughput maximization problem for a network that consists of multiple overlapping WLANs is the maximization of

$$S = \sum_{i=1}^N \sum_{j=1}^{n_i} s_{i,j} \quad (4)$$

where N is the number of cells, n_i is the number of STAs at the i^{th} cell, and $s_{i,j}$ is the throughput of the j^{th} STA at the i^{th} cell. It should be noted that the nodes that operate under the

same frequency channel and that are in each others' sensing range share the same P_{sc} and ATR regardless if they associated with a same or different APs.

In the traditional AP selection policy, a STA associates with the AP corresponding to the strongest RSSI. Thus, such a scheme takes account of only the second component of (3), r . However, increasing r alone does not necessarily increase the total throughput, especially when STAs distribution is highly non-uniform. In such a scenario, it is possible that most of the STAs select a same AP (because they are closer to that AP). As it can be seen in (2), P_{sc} decreases sharply with the increase of n (because the numerator approaches zero and denominator approaches 1). Thus, in such a case, the throughput of the traditional scheme is poor because of a small P_{sc} for the crowded cell(s) and likely a small ATR for the scarce neighboring cell(s). This suggests distributing STAs to the existing cells. Indeed several schemes are proposed to distribute the number of STAs among cells, and some of them take account of the link quality (RSSI in [3], and packet error rate in [6]). A drawback of these schemes is that they do not consider ATR, the channel availability.

Reference [7] proposed to balance effective channel busy-time (i.e., time the channel is busy for successful transmissions) among cells. Because it does not discriminate the time corresponding to unsuccessful transmissions and the idle time, [7] may suffer from such estimation errors. Moreover, because [7] ignores offered traffic volume, it might take a long time until load is balanced.

ATR is also the ratio of the amount of bandwidth consumed for transmissions to the total bandwidth. Thus, an increase of the offered traffic volume (injected traffic) increases ATR until it reaches its saturation value. Further increase of the offered traffic, however, results in congestion (i.e., buffer overflow) that significantly hampers communication performance. Since a cell with a small ATR can accommodate additional traffic, the overall throughput can be improved by moving STAs from the congested cell to such a non-congested cell. References [8], [4] proposed schemes that balance traffic volume among cells. A drawback of the schemes is that they do not consider the fact that the overlapping cells operating under the same frequency channel share the same channel resource. Moreover, [7], [8], [4] do not consider the link quality (the second component of (3)), and thus they may force STAs to use links with poor quality, degrading the users' throughput. To the best of our knowledge, none of the existing schemes takes account of the overall of (3), thus they do not necessarily maximize throughput.

To this end, we propose an association control scheme that takes account of the overall of (3). The direct target of the proposed scheme is to maximize the sum of the multiplication of the second and third components of (3), r and ATR, by taking account of RSSI, ATR, and the offered traffic volume. The success probability, P_{sc} , is indirectly maximized by maintaining ATR smaller than a threshold value. The next section provides an analytical study on why and how P_{sc} can be maximized by controlling ATR. An important difference of the

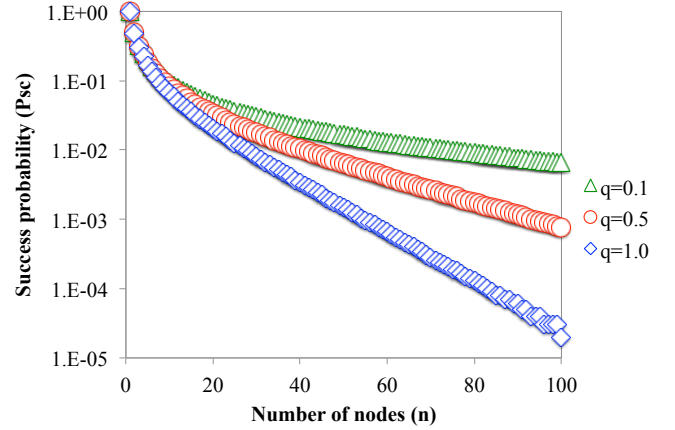

Figure 2. Success probability as a function of the number of contending nodes. The figure shows that P_{sc} sharply decreases with the increase of the number of nodes. The smaller the probability of having a pending frame (q), the larger is the P_{sc} .

proposed scheme from the previous schemes is that because both the offered traffic and channel availability are estimated for each cell, the proposed scheme does not aim at load balancing. This enables the scheme to maximize throughput by utilizing fewer APs, providing a positive impact on energy efficiency.

III. STUDY ON AIR-TIME RATIO AND SUCCESS PROBABILITY

Equation (3) shows that the throughput of a node can be expressed by the multiplication of the three components: the success probability (P_{sc}), the average data transmission rate (r), and air-time ratio (ATR). The first and second components are further expressed as functions of the number of contending nodes (n) and link quality (RSSI), respectively. RSSI and ATR are local link and channel condition that can easily be monitored using the existing WLAN devices. On the other hand, the nodes that contribute P_{sc} can be beyond the transmission range of each other (i.e., they cannot correctly receive the packets from each other). Therefore it is an extremely difficult task to count the number of such nodes.

This section will show that the success probability (P_{sc}) can be indirectly maximized by controlling the air-time ratio (ATR). Before getting into the details, we will first show that it is necessary to maximize P_{sc} for throughput maximization.

As (2) shows, P_{sc} is a function of the number of nodes and the channel access probability (τ). τ is further expressed in [10]

$$\tau = q \times \frac{1 + \sum_{k=1}^{L_{\text{retry}}} (1 - P_{sc})^k}{CW_0 [1 + \sum_{k=1}^{L_{\text{retry}}} 2^k (1 - P_{sc})^k]}, \quad (5)$$

where q is the probability of having a pending data frame (to transmit), CW_0 is the minimum contention window size, and L_{retry} is the frame retransmission limit [11]. We now calculate the success probability (using (5) and (2)) for the IEEE 802.11a system [11]. Table I shows the parameters used in the calculation. Fig. 2 shows the success probability (P_{sc})

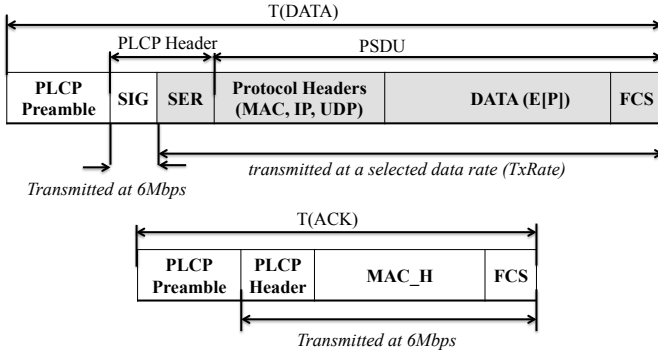

Figure 3. T' the sum of the times required for transmissions of a data frame and the corresponding acknowledgment frame. PLCP SIGNAL field duration and ACK frame are generally coded with 1/2 BPSK (i.e., 6 Mbps rate) in the IEEE 802.11a systems. The shaded area of the data frame is transmitted at a rate ($TxRate$) selected by the MAC rate adaptation mechanism.

for different numbers of nodes. While the smaller the q , the larger is the P_{sc} , it is clear that P_{sc} sharply degrades with the increase of the number of nodes (note that the vertical axis is on a logarithmic scale).

We now express ATR by P_{sc} , P_{tr} , the probability that there is at least one station transmits (see (1)) is

$$P_{tr} = 1 - (1 - \tau)^n \quad (6)$$

By substituting P_{tr} to the formula of ATR (the 3rd component of (3)), the following relation of ATR and P_{sc} can be achieved.

$$ATR = \frac{1}{P_{sc} \frac{(1-\tau)\sigma}{T'\tau} + \frac{DIFS+SIFS}{T'} + 1} \quad (7)$$

Here T' is the time required for the transmission of a data frame without including the inter-frame spaces (DIFS and SIFS). Because T' is more convenient to monitor than T (which includes the inter-frame spaces) in the real systems, we use T' in this and the following sessions. For simplification of the mathematical calculations, we target the basic access method (i.e., the RTS/CTS (Request to Send and Clear to Send) handshake is not used). In such a case, T' is the sum of the average time required for the transmissions of a data frame and the corresponding acknowledgement frame (ACK) (see Fig. 3).

Substituting (7) to (3), the throughput of a node is expressed slightly differently from (3):

$$s = r' \times \frac{1}{\frac{(1-\tau)\sigma}{T'\tau} + \left(\frac{DIFS+SIFS}{T'} + 1\right) \frac{1}{P_{sc}}} \quad (8)$$

where $r' = E[P]/T'$.

Using (8), (5), and (2) we now calculate the throughput for the IEEE 802.11a system. In the IEEE 802.11a, the acknowledgement frame (ACK) and the SIGNAL field of the PLCP header (the PLCP header fields excluding the SERVICE field) are generally coded with 1/2 BPSK (6 Mbps). The PSDU (physical layer service data unit) and the SERVICE field of the PLCP header in the data frame (the shaded part in Fig. 3)

TABLE I
PARAMETERS USED IN THE PERFORMANCE ANALYSIS

Parameter	Value	Note
σ	$9\mu s$	Slot time
SIFS	$16\mu s$	Short Inter-Frame Space
DIFS	$34\mu s$	DCF Inter-Frame Space
CW_0	16	Minimum contention window size
L_{retry}	4	Frame retransmission limit
PLCP preamble	$16\mu s$	PLCP preamble duration
PLCP_SIG	3 bytes	PLCP SIGNAL field length
PLCP_SER	4 bytes	PLCP SERVICE field length
MAC_H of data frame	24 bytes	MAC header of data frame
MAC_H of ACK frame	10 bytes	MAC header of ACK frame
FCS field	2 bytes	
IP header size	40 bytes	IPv6 header
UDP header size	8 bytes	
E[P]	500 bytes	Data size

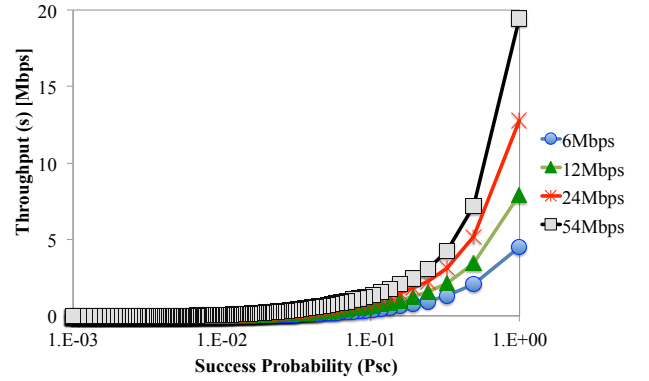

Figure 4. The throughput performance as a function of the success probability. The figure shows that for a sufficient throughput is achieved only when the success probability is large.

are subject to the MAC rate adaptation and thus we calculate the corresponding transmission time for different data rates. Fig. 4 shows the impact of the success probability, P_{sc} , on the throughput performance for different data rates. First of all, the figure shows that higher the utilized data rate (i.e., better link quality), the larger is the achieved throughput, implying the necessity of considering the link quality, i.e., the second component of (3). An important observation that can be made from the figure is that a sufficient throughput can be achieved only when P_{sc} is large.

Now we will show the impact of P_{sc} on ATR. In fact we can easily see in (7) that ATR takes on its maximum value, ATR_{max} , when P_{sc} is 0. In this case, however, the channel is occupied with packet collisions, and obviously, the throughput is minimized (see Figure 4). On the other hand, if P_{sc} is 1 (i.e., channel utilization is maximized), ATR takes on a value smaller than ATR_{max} , implying that the optimal value of ATR, ATR_{opt} is below ATR_{max} [12].

Now we will have a closer look at the relationship of ATR and P_{sc} . We substitute (5) to (7) and calculate ATR for the IEEE 802.11a system.

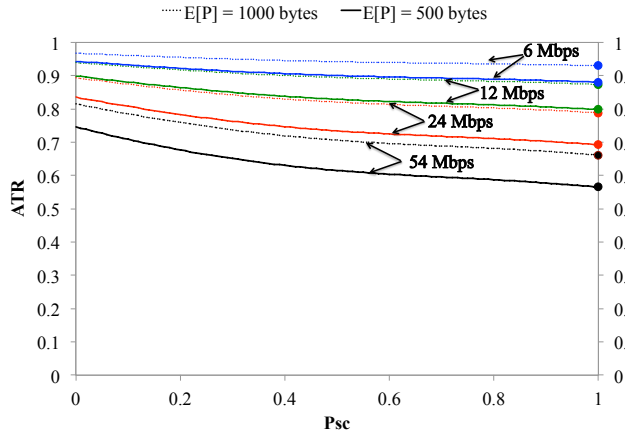

Figure 5. ATR characteristics with respect to the success probability, P_{sc} . Note that the solid (dashed) lines correspond to 500 bytes (1000 bytes) of data size. The figure clearly shows that ATR is maximized when P_{sc} is minimized. The optimal value of ATR (that maximizes P_{sc}) is smaller than the maximum value of ATR. The figure also shows that the larger the data rate, the smaller is the ATR and the larger the data size, the larger is the ATR.

Fig. 5 shows the ATR characteristics with respect to P_{sc} for different data sizes ($E[P]$) and data rates. The figure clearly shows that ATR is maximized when P_{sc} is minimized; an increase of P_{sc} results in a gradual decrease of ATR. Moreover the larger the utilized data rate, the smaller is the ATR; the larger the data size, the larger is the ATR. The figure clearly shows that different optimal values exist for different data rate and data size. For example ATR_{opt} is 0.57, 0.66, 0.88, and 0.92 for the data rate and data size combinations of (54 Mbps, 500 bytes), (54 Mbps, 1000 bytes), (6 Mbps, 500 bytes), and (6 Mbps, 1000 bytes), respectively. (ATR_{opt} are shown with the round markers in the figure).

Our objective is to find a threshold value, ATR_{th} , which is used by our association control scheme to ensure P_{sc} be sufficiently large. Because ATR_{opt} takes on different values depending on the data size and the data rate, it is maybe possible to design a mechanism that finds the exact ATR_{opt} and set ATR_{th} to that value. However, designing such a mechanism can be very complex because it requires a precise estimation of the average data rate and the average data size. We believe that it is simple and thus realistic to set ATR_{th} to a fixed value. In WLANs, the users can be very close to the APs, i.e., the link quality (RSSI) can be good enough for a use of the highest data rate. Thus, it is safe to set ATR_{th} to ATR_{opt} corresponding to the highest data rate (i.e., 54 Mbps for the IEEE 802.11a). The data size, on the other hand, can be monitored or it can be set to a value, which is used by the typical applications. Thus according to Fig. 5, if the data size is 500 bytes, ATR_{th} should be set to 0.57. In fact, in our previous work [1], we have empirically found that it is appropriate to set ATR_{th} to 0.58 for WLANs for scenarios where data size takes on a value between 500 to 540 bytes. The analytical calculation achieved in Fig. 5 proves the correctness of the empirically-found threshold value.

As the success probability, P_{sc} , can be maximized by main-

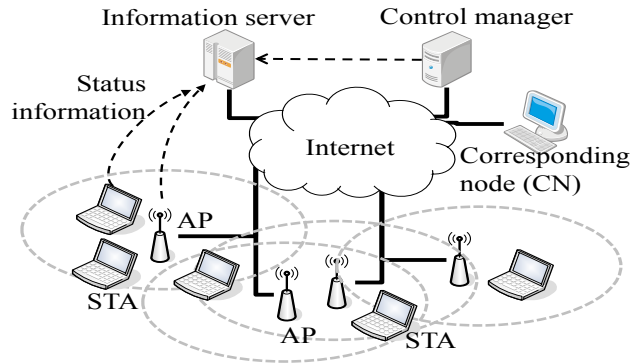

Figure 6. Besides having user-owned APs and STAs, the target community network has a centralized control manager. The information that are necessary for network management is collected by APs and/or STAs and gathered at an information server.

taining ATR below the threshold value (ATR_{th}), the throughput maximization problem can be rewritten as

$$\begin{aligned} \text{Maximize } S &= \sum_{i=1}^N \sum_{j=1}^{n_i} [r_{ij} \times ATR_{ij}] \\ \text{subject to } ATR_{ij} &< ATR_{th} \quad \forall (i, j) \end{aligned} \quad (9)$$

where N is the number of cells, n_i is the number of STAs at the i^{th} cell. r_{ij} and ATR_{ij} are the average frame transmission rate and ATR corresponds to the j^{th} node at the i^{th} cell.

IV. PROPOSED SCHEME

A user-owned AP is integrated into a community network by a common equipment/software program provided by the entity (e.g., FON [2]). Besides integrating users' APs, the entity can play an important role for, e.g., network management for better communication quality. Hence, community networks are centrally controllable and we expect that the community members (i.e., the users) are cooperative to such a control. To this end, while a distributed mechanism can also be designed, in this paper, we propose a centralized association control scheme due to ease of management and better performance [7], [8], [5]. The proposed scheme aims at maximizing network throughput by a congestion alleviation mechanism and reducing energy consumption by a cell aggregation mechanism. For a large community network, the network can be divided into sub-networks, which are independently and separately controlled. Fig. 6 shows the network architecture.

Besides APs and STAs, the network has an information server (server) and control manager (manager). The server and manager can be physically separated or coexist in a same machine. APs and STAs periodically inform the server of information on the link quality, channel availability, and traffic volume. Periodically referring to the information, the manager triggers STAs' handover for improved network throughput and/or energy efficiency.

A. Estimation of Channel Availability and Offered Traffic

STAs and APs measure RSSI, ATR, and the offered traffic volume, and inform the server of the information. The manager

uses the information to estimate channel availability and traffic condition for each cell, and changes STAs associations.

- Frame transmission rate

By periodically performing channel scanning, STAs are aware of the existence of the neighboring APs and the corresponding $RSSI_{AP,STA}$. Such background scanning is supported by the off-the-shelf wireless LAN cards [13], and some efforts have been made for fast channel scanning [14]. Transmission rate for frame payload field is estimated from $RSSI_{AP,STA}$ and finally the frame transmission rate, $r_{AP,STA}$ ($\approx E[P]/T$), for each pair of STA and AP is calculated.

- ATR

Because ATR value does not largely change over the space (e.g., it is around the same in the transmission range), only APs measure ATR on their operating channel. Such a measurement can easily be made using the existing WLAN cards [7], [5], [15]. We empirically found that the appropriate values for ATR_{th} are 0.58.

- Potential Throughput

The manager estimates the maximum achievable throughput for each pair of STA and its neighboring AP (which is not the STAs currently associated AP). Let $PT_{STA,AP}$ (potential throughput) represent the maximum achievable throughput for such a STA and an AP. Equation (3) shows that the potential throughput is a function of P_{sc} , the estimated transmission rate ($r_{AP,STA}$), and ATR_{AP} . As discussed in the previous section, however, P_{sc} can be maximized by ensuring ATR below ATR_{th} . This enables PT to be estimated only from $r_{AP,STA}$ and ATR_{AP} . Thus the manager calculates PT for each STA and its neighboring AP as

$$PT_{AP,STA} = \begin{cases} 0 & ATR_{AP} \geq ATR_{th} \\ (ATR_{th} - ATR_{AP}) \times r_{AP,STA} & \text{otherwise} \end{cases} \quad (10)$$

The upper equation is to not move the STA to the AP, at which ATR_{AP} exceeds ATR_{th} . Otherwise, the AP is a candidate destination AP for the STA, and the maximum achievable throughput at the candidate cell is expressed as the lower equation. In our previous work [15], we confirmed that such an estimation of PT can be achieved with a high accuracy using the existing WLAN cards.

- Offered Traffic

A STA can be moved to a neighboring AP, if it does not cause congestion at the neighboring cell. The condition can be verified by comparing the offered traffic volume for the STA and $PT_{STA,AP}$ (to be discussed later). Letting $EnqueueRate_{A,B}$ be the rate at which packets destined to node B are inserted into the IP queue at node A, the offered traffic volume for a STA is defined as

$$OfferedRate_{STA} = EnqueueRate_{STA,AP} + EnqueueRate_{AP,STA} \quad (11)$$

If the WLAN is the bottleneck link of the end-to-end route, the OfferedRate is approximately equal to the traffic generation rate.

B. Congestion Alleviation

A cell is considered to be congested if

$$ATR > ATR_{th} \quad (12)$$

If the condition (12) is met for a cell, the manager checks if the aggregate offered rate exceeds the aggregate packet throughput for that cell, i.e.,

$$\alpha \sum_{STAs} OfferedRate_{STA} > \sum_{STAs} PacketThroughput_{STA} \quad (13)$$

Here α (< 1) is a system parameter to absorb rate fluctuation. $PacketThroughput_{STA}$ is the sum of the rates at which packets are successfully transmitted on the uplink and downlink for the STA. The condition (13) indicates that one or more nodes belonging to the cell are experiencing buffer overflow. It is possible that a cell satisfies (12) but not (13), in a case, when the cell does not have much traffic but the channel is congested due to the transmission activities at the overlapping cells.

A cell that satisfies both (12) and (13) becomes a target cell of congestion control. Letting AP_t be the AP of the target cell, the manager selects STAs to move from AP_t to its neighboring cells. The association control is made based on the following policies:

- 1) The number of moving STAs should be as small as possible.
- 2) A STA should be moved only if it will not cause congestion at the destination cell.
- 3) Among the candidate destination APs, the STA should be moved to the AP corresponding to the strongest RSSI.

The more the number of handovers, the larger is the control overhead. Thus policy 1 is to minimize the number of moving STAs. To support this objective, we define load of a STA, as $Load_{STA} = OfferedRate_{STA} / TxRate_{STA,AP_t}$. Here $TxRate_{STA,AP_t}$ is the data rate used for transmissions of frame payload fields between the STA and AP_t (the shaded part in Fig. 3). Obviously, the larger the offered traffic and/or the lower the transmission rate, the heavier loaded is the STA for AP_t . For policy 1, heavier loaded STAs are preferred to be moved (from AP_t) over lighter loaded STAs. For policy 2, a STA is moved to a neighboring AP, AP_d , only if the condition (14) is met.

$$OfferedRate_{STA} < PT_{STA,AP_d} \quad (14)$$

In other words, the STA is moved to AP_d only if the destination cell can accommodate the offered traffic volume for the STA. Finally, among the candidate destination APs (i.e., the APs that satisfy (14) for the STA), the AP corresponding to the strongest RSSI is selected as the destination AP for the STA.

When a STA, $STAm$, is selected to be moved from AP_t , the manager updates the aggregate offered rate (see (13)) for the target cell by decrementing it by $OfferedRate_{STAm}$. Moreover ATR for the destination cell and its overlapping cells (which operate using the same channel) is incremented by $OfferedRate_{STAm} / r_{AP_d,STAm}$. After updating the values, the

manager checks if the target cell still satisfies (13). If it does, the manager searches the next STA to move from APt.

- Discussion on TCP traffic

TCP reacts to congestion and controls its rate based on AIMD (Additive Increase Multiplicative Decrease) algorithm. However such a rate change occurs in the order of RTT (round-trip time), i.e., in order of milliseconds, while the control period at the manager is in order of seconds. Therefore we expect that the proposed scheme does not react to the AIMD-based rate fluctuation, but only to the gradual change of the average rate. Hence, the proposed scheme and TCP can stably coexist. Moreover because TCP adjusts its traffic rate, $\text{OfferedRate}_{\text{STA}}$ for STA might be largely changed due to the STAs movement. However, it should be reminded that a STA is moved to a neighboring cell only if the destination cell can accommodate the current OfferedRate for the STA (see (14)). Thus, we expect that TCP throughput will be increased or maintained after the STAs movement. Furthermore, since some amount of channel resource is released at the previous cell of the moving STA, STAs in that cell can now increase their rate.

C. Cell Aggregation

Since both of the offered traffic volume and the channel availability are known for each cell, load balancing among cells is not necessary. Indeed, if all the associated STAs of an AP can be moved to its neighboring cells without hampering the network throughput, such STA movements should be encouraged for energy efficiency, since the AP can now be in the power-saving mode. Our scheme can provide such an association control based on the following policies:

- 1) The target AP is an AP that is associated with preferably few STAs, which all can be moved to the neighboring cells.
- 2) To suppress channel interference, the target AP should have overlapping cells that operate using the same frequency channel.
- 3) Policy 2 described in the previous subsection.
- 4) Policy 3 described in the previous subsection.

The manager triggers a handover only if destination APs are found for all the STAs of the target AP. A detailed protocol design for actually putting APs in the power-saving mode is left for our future work. The main concern of such a protocol design is to ensure newly arriving STAs are covered by the network. For such a control, Wake-on-WLAN technology [16] can be used.

D. Changing STA's Association

To change a STA's association, the manager sends a control frame to the STA, indicating the destination AP and the corresponding channel information. Such a network directed association control can be supported by the upcoming IEEE 802.11v [17], which enables APs to explicitly request STAs to re-associate with an alternate AP.

TABLE II
USER DISTRIBUTION FOR EACH SCENARIO

	Circle1 (station)	Circle2 (condominium)	Circle3 (McDonalds)	Circle4 (overall area)
S1	0	0	0	40
S2	10	10	10	10
S3	10	20	0	10
S4	10	20	10	0
S5	20	10	0	10
S6	30	0	0	10
S7	40	0	0	0

V. SIMULATION EVALUATION

Using Scenargie network simulator [18], we investigate the proposed scheme with and without cell aggregation capability. The performance of the proposed scheme is compared against:

- Strongest RSSI: The traditional AP selection scheme.
- LB(NumofSTAs): A load balancing scheme [3], which takes account of the number of STAs and RSSI.
- LB(Traffic): A load balancing scheme [8], where load of a cell is defined by traffic rate.

In each scheme, STAs initially associate with APs based on the strongest RSSI policy. In the proposed scheme, STAs inform the server of the measured information using a 160-bytes packet. The manager checks the collected information in every second. 20-bytes of packets are used for handover requests and replies between the manager and moving STAs. α (see (13)) is set to 0.98.

The performances of the schemes are investigated targeting the real-world scenario depicted in Fig. 1, where 14 APs are non-uniformly distributed in a 600×600 m² area. 8 APs are concentrated in the small area (around the condominium), the remaining 6 APs are installed in the rest of the overall area as shown in the figure. The network operates using the IEEE 802.11a [11], using 3 orthogonal frequency channels. The frequency channels are allocated (to the APs) following a simple graph coloring technique.

STAs (users) can be anywhere, but it is natural to expect that users are especially attracted to the public places specifically, the train station, condominium building (for the café), and McDonalds shown in the target area. Thus, in our simulations, 40 STAs are distributed in the circle-shaped areas centered at the 1) train station, 2) condominium building, 3) McDonalds, and 4) the center of the map, with a radius of 100, 10, 10 and 300 meters, respectively (see Fig. 1). The first three areas are to create users concentration in the public places, while the last area is for uniform distribution of users in the overall area. Table II shows the simulation scenarios, which have different number of STAs in each circle-shaped area. The smaller the scenario number, the more uniform is the STAs' distribution.

The simulation evaluations are conducted for TCP and UDP traffic. In TCP simulations, STAs upload 5 MB of file using FTP/TCP-SACK. In UDP simulations, STAs have uplink and downlink CBR traffic generated at a random rate in the range of [0 Mbps, 1.2 Mbps]. The data size is set to 512 bytes for

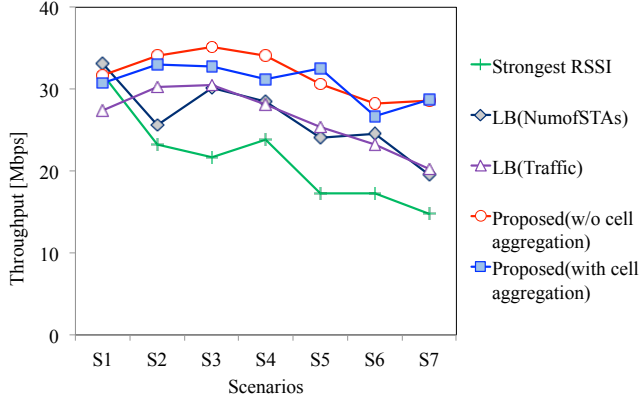

(a) TCP traffic

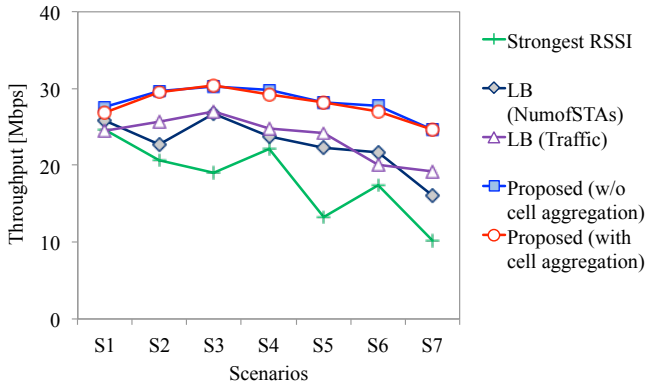

(b) UDP traffic

Figure 7. Comparing throughput performance for TCP and UDP traffic. The figures show that Strongest RSSI scheme is inferior to the remaining schemes and the proposed scheme shows the best performance.

both TCP and UDP traffic.

Fig. 7 compares the network throughput for the TCP and UDP traffic. As the figures show, the performance of Strongest RSSI scheme is inferior to the remaining schemes and the proposed scheme shows the best performance. The proposed scheme with the cell aggregation mechanism achieves around the same throughput performance as the scheme without cell aggregation, especially for UDP traffic. The load balancing schemes have lower throughput than the proposed scheme, conceivably because they do not take account of the overall of (3).

The figures also show that, in general, the throughput tends to be smaller when STAs' distribution is less uniform (e.g., the throughput of S7 is smaller than that of S5). As discussed in Section II, the reason is clear for the strongest RSSI scheme (many STAs select the same AP). The reason for the remaining schemes is as follows. When STAs are highly concentrated around a particular AP, the schemes have to move some of the STAs to farther APs. This reduces the frame transmission rate, r , for the moving STAs, resulting in lower throughput compared to that of a scenario where STAs' distribution is

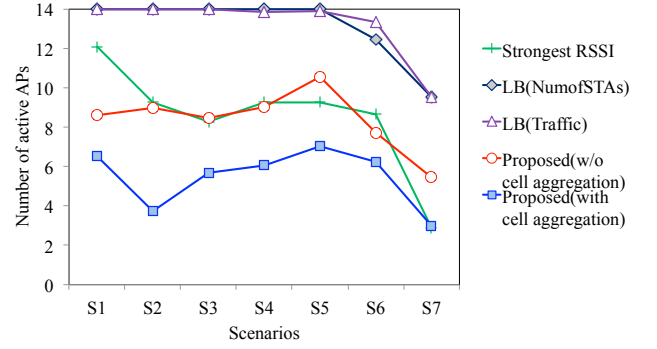

(a) TCP traffic

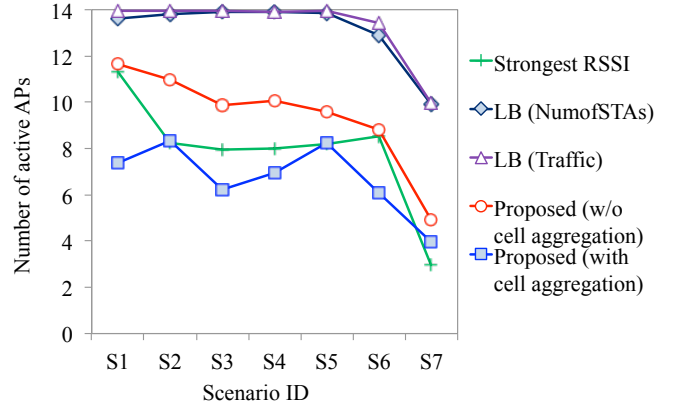

(b) UDP traffic

Figure 8. Comparing the number of active APs for each scheme. The figures show that the load balancing schemes tend to use all the existing APs. The proposed scheme without cell aggregation utilizes around the same number of APs as that of Strongest RSSI scheme. The proposed scheme with cell aggregation utilizes the smallest number of APs.

more uniform. Nevertheless, compared with the strongest RSSI scheme, the overall throughput is improved due to an increase of the 1st and 3rd components of (3). Finally, S1 (where STAs' distribution is uniform), however, does not show the largest throughput due to the non-uniform AP distribution.

Fig. 8 compares the number of active APs, i.e., the number of APs that actually serve for the users. As the figure shows, the load balancing schemes use all the existing APs (except in scenario S7, where STAs are concentrated only at the train station). Strongest RSSI scheme, on the other hand, does not use many APs due to its simple AP selection policy. The proposed scheme without cell aggregation utilizes around the same number of APs as that of Strongest RSSI scheme. Finally, the scheme with cell aggregation utilizes the smallest number of APs. This is especially attractive because compared to the existing schemes, the proposed scheme largely improves throughput by utilizing fewer APs. Our future work includes a study on how much energy reduction can be achieved by such an association control.

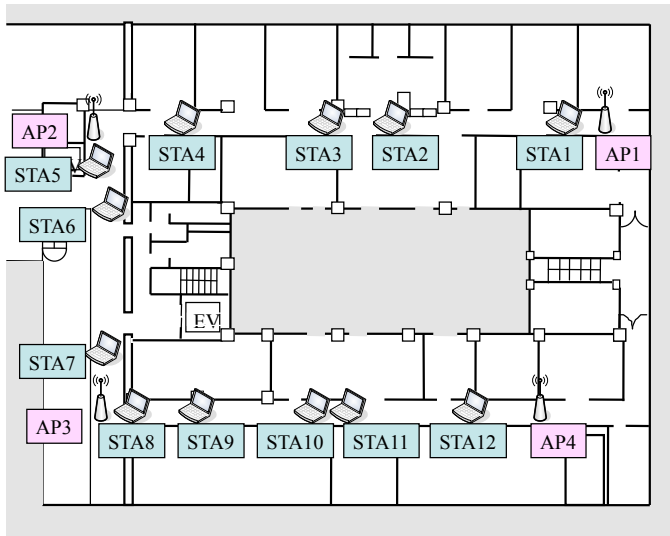

Figure 9. An active office area, which has a complicated room and obstacle structure and intermittent movement of people, is used as the test environment. The test scenario consists of 4 APs and 12 STAs. STAs are initially associated with the APs using the strongest RSSI method.

VI. TESTBED EVALUATION

We implemented the proposed scheme in a wireless testbed and evaluated its throughput performance. Computers with CentOS 5.5 (kernel 2.6.25-17) are used for STAs, APs, and the manager (note that the manager and server coexist on a same machine). The APs, the manager, and a source computer (acting as a corresponding node (CN)) are connected to a 100 Mbps Ethernet. The APs and STAs are equipped with IEEE 802.11a WLAN cards made by NEC (Aterm WL54AG). We modified the Atheros device driver to enable measurements of ATR and PacketThroughput (see (13)). The packet transmission rate from the kernel to the device driver is monitored to measure EnqueueRate (see (11)). TCP is used for information collection at the server and for handover requests and replies.

As the testbed environment, we selected an active office area, which has a complicated room and obstacle structure and intermittent movement of people. Fig 9 shows the testbed environment. It consists of multiple rooms connected by long corridors, surrounding a central well. Unless otherwise noted, the test system consists of 4 access points (AP1-AP4) and 12 STAs (STA1-STA12) that are positioned as illustrated in the figure. STAs are initially associated with APs based on the strongest RSSI method. The relative positioning enables each AP to be initially associated with 3 STAs (STA1-STA3 are with AP1, STA4-STA6 are with AP2, STA7-STA9 are with AP3, and STA10-STA12 are with AP4).

To see the impact of the proposed scheme, the manager is initially disabled and it is activated after around 40 seconds. Unless otherwise noted, the offered traffic volume for individual cells are initially set to be largely different. Moreover, in order to create traffic dynamics, additional traffic is injected to some cells after around 30 seconds. To simplify experi-

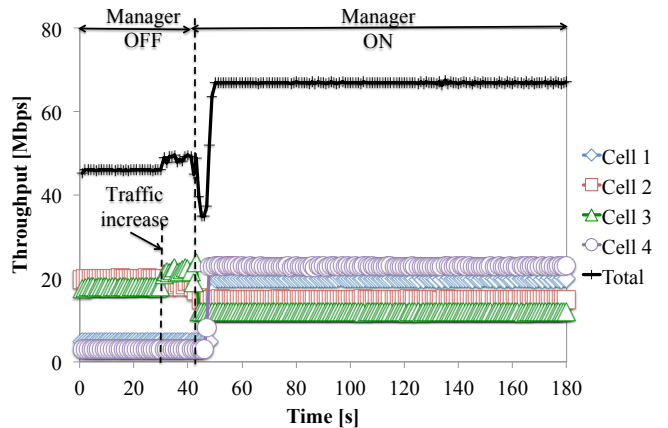

Figure 10. Throughput performance of the congestion alleviation method. In this scenario all STAs have CBR/UDP traffic. Upon activation of the manager, STAs are moved from the congested cells (cells 2 and 3) to the non-congested neighboring cells (cells 1 and 4). The aggregate throughput is largely improved by the association control.

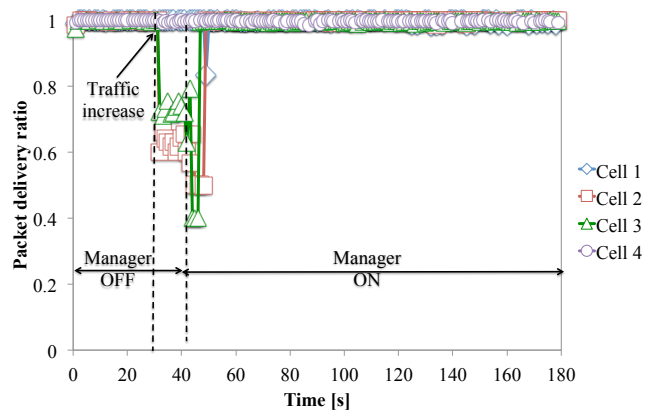

Figure 11. Packet delivery performance of the congestion alleviation method. Due to the additional traffic injected after around 30 seconds, the packet delivery ratio largely degrades down to 60%. Upon activation of the manager, the delivery performance is recovered back to 100%.

mentation, the CN (corresponding node) generates traffic for individual STAs (i.e., downlink traffic), enabling the offered traffic volume to be adjusted only at CN. Three orthogonal frequency channels of the IEEE 802.11a are allocated such that AP1 and AP3 share the same channel and AP2 and AP4 use the remaining two channels. The testbed evaluations made for three scenarios: the first scenario is to evaluate congestion alleviation method for UDP traffic, the second scenario is to evaluate congestion alleviation method for TCP and UDP traffic, and the last scenario is to evaluate cell aggregation method.

A. Congestion alleviation for UDP traffic

CBR/UDP traffic is generated for individual STAs. Initial setting of the aggregate offered traffic at cells 1, 2, 3 and 4 are 5, 20, 18, and 3 Mbps, respectively. At 30 seconds, the offered traffic rate for cells 2 and 3 are further increased by 10 Mbps.

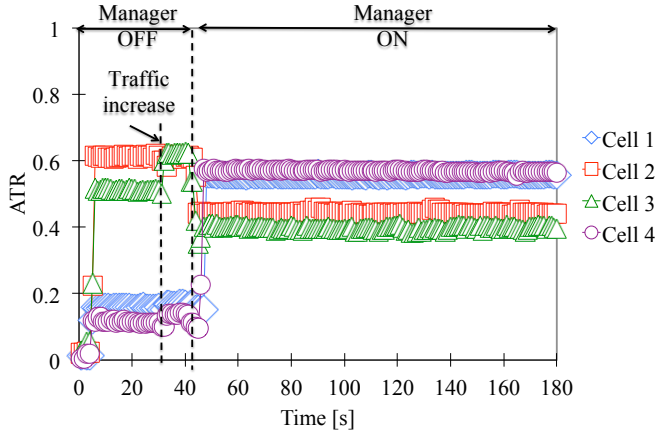

Figure 12. ATR measured at each APs. The figure shows that ATR can be well tuned by the association control to the desired value.

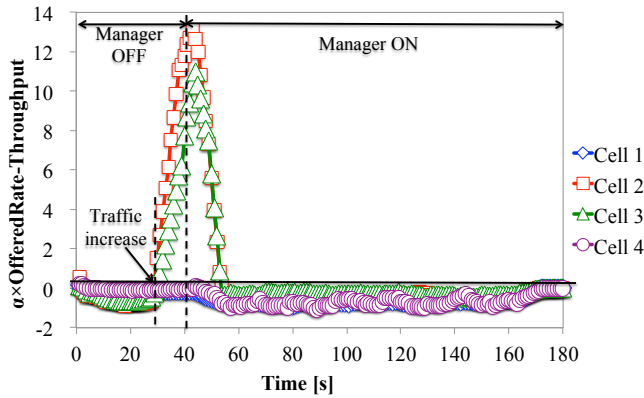

Figure 13. $\alpha \times \sum_{STAs} \text{OfferedRate}_{STAs} - \sum_{STAs} \text{PacketThroughput}_{STAs}$ at each cell. The figure shows that the parameter reacts well to buffer overflow.

Figs. 10 and 11 show the time series plots of the throughput and packet delivery performance for each cell. Because cells 2 and 3 were initially very loaded, the additional traffic injected to the cells (at around 30 seconds) results in only a slight increase of the total throughput. As the offered traffic volume requires a larger resource, as Fig. 11 shows, the cells could not accommodate the overall offered traffic, and hence the packet delivery ratio drops down to 60%. Upon activation of the manager (at around 40 seconds), STAs are moved from congested cells (cells 2 and 3) to non-congested neighboring cells (cells 1 and 4), and the packet delivery ratio is maximized by the association control.

Figs. 12 and 13 show the time series plots of ATR and $\alpha \times \sum_{STAs} \text{OfferedRate}_{STAs} - \sum_{STAs} \text{PacketThroughput}_{STAs}$, the parameters used to trigger congestion control (see (12) and (13)). Two important observations can be made from Fig. 12. Firstly, before the congestion (before 30 seconds), ATR at Cell2 already exceeds the threshold value, but as it can be seen in Figs. 11 and 13, there was no buffer overflow. This teaches us that ATR above ATR_{th} does not necessarily indicates buffer overflow. The second point can be observed

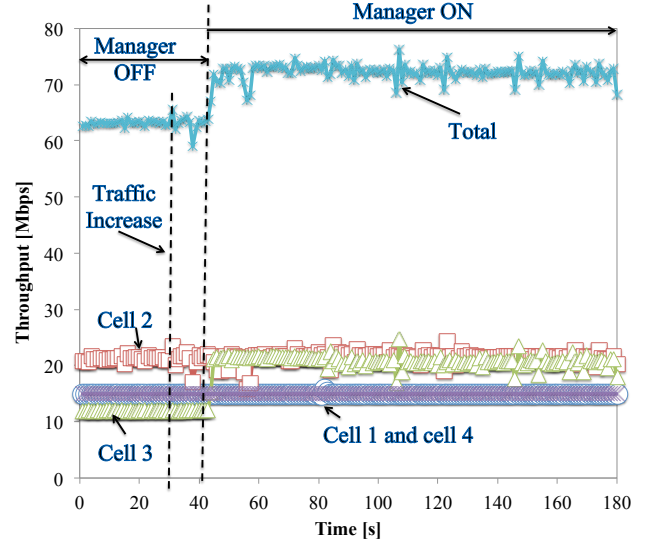

Figure 14. Throughput performance of each cell. In this scenario, TCP and UDP traffic share the same resource at Cell2. Upon activation of the manager, a STA with UDP traffic is moved to Cell3. With this association control, more than 10 Mbps throughput improvement is achieved.

in Fig. 12 is that ATR can be tuned well to the desired level, ATR_{th} . Fig. 13 shows that $\alpha \times \sum_{STAs} \text{OfferedRate}_{STAs} - \sum_{STAs} \text{PacketThroughput}_{STAs}$ reacts well to the congestion and together with ATR, it can be a good indication of congestion for UDP traffic.

Figs. 10-13 show that unfortunately, it took approximately 6 seconds to complete the handover (without depending on the number of moving STAs). The 6 seconds are used for 1) MAC layer disassociation/association, 2) IP route advertisement, 3) IP duplicate address detection, 4) Mobile IP binding update, and 5) Mobile IP binding acknowledgement. Among the operations, there was a software bug corresponding to 2) and we confirmed that by fixing this bug, handover time can be reduced down to 3 seconds. We are now working on this issue.

B. Congestion control for TCP and UDP traffic

The CN generates TCP traffic to the STAs at cells 1, 3, and 4. For Cell2, TCP traffic is generated for STA5, and UDP traffic is generated for STA4 and STA6. The initial settings of the maximum offered traffic volume (i.e., the sum of the CBR rate and the maximum rate of TCP) for the cells 1, 2, 3, and 4 are 15, 27, 12, and 15 Mbps, respectively. At around 30 seconds, the UDP traffic for STA4 is further increased by 5 Mbps. Fig. 14 shows the time series plots of the aggregate throughput and throughput of individual cells. Upon activation of the manager, STA6 is moved from Cell2 to Cell3. This improves the aggregate throughput by approximately 10 Mbps.

Fig. 15 gives a closer look at the time series plots of the individual throughput at Cell2 and Cell3. The offered CBR rate and the maximum offered TCP rate for each STA are also noted in the figure. Until 30 seconds, the UDP throughput achieved for STA4 and STA6 (in Cell2) are 10 Mbps, which are equal to the offered rate. On the other hand, the throughput

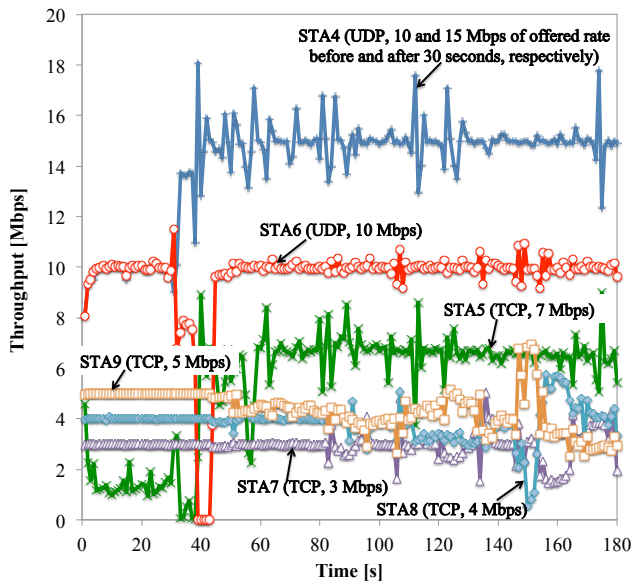

Figure 15. Throughput of individual STAs at cells 2 and 3. Upon activation of the manager, STA6 is moved from Cell2 to Cell3. This enables TCP traffic at STA5 to increase its rate up to its maximum rate and the UDP traffic at STA4 also achieves its maximum throughput.

of TCP traffic (for STA5) is only 2 Mbps, which is much lower than the maximum offered rate (7 Mbps). The additional traffic injected for STA4 (at around 30 seconds) results in a large throughput degradation for both STA6 and STA5. The throughput degradation is especially significant for the TCP traffic for STA5 (down to 0 Mbps). This clearly shows severe unfairness between TCP and UDP traffic. At around 40 seconds, the manager is activated, then STA6 is moved to cell 3. After approximately 5 seconds of handover delay (due to the issues mentioned in the previous subsection), all the traffic at both the cells could be transmitted at their maximum rate, resulting in 10 Mbps of throughput improvement.

In the above mentioned scenario, a STA with UDP traffic is moved from the congested cell. Fig. 16 shows results achieved from an experiment where STAs with TCP traffic are moved. In the experiment, the target scenario consists of two cells: one has three STAs (STA1-STA3) and the other has one STA (STA4). The manager is activated at around 70 seconds. STA1 and STA4 have UDP traffic with 25 and 10 Mbps of offered rates, respectively. STA2 and STA3 have TCP traffic with maximum 6 Mbps of offered rate. As the figure shows, until activation of the manager, due to the large traffic volume offered to STA1, the coexisting TCP traffic significantly reduced their traffic rate down to 0 Mbps. Upon activation of the manager, the STAs with TCP traffic are moved from Cell1 to Cell2. The association control results in the TCPs increase their traffic rate at the destination cell.

The results achieved in Figs. 10-16 also show that monitoring/estimation of traffic, channel, and link condition made at Layer1-Layer 3 are realized with sufficient accuracy. However because TCP controls its rate at Layer 4, the OfferedTraffic estimated at Layer 3 is the result of the TCP's rate adap-

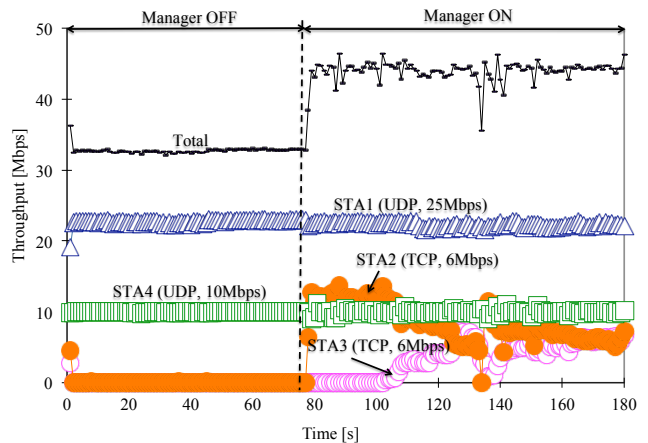

Figure 16. Throughput of individual STAs for a scenario where STAs with TCP traffic are moved (STA2 and STA3). The TCP traffic could achieve increased throughput at the destination cell.

tation. This implies, on the one hand, that the proposed congestion alleviation scheme does not negatively affect the TCP's congestion control, and the two congestion control schemes can stably coexist. On the other hand, however, if the proposed scheme is aware of the TCP's maximum rate, further throughput improvement is possible. The following is a list of some approaches for this challenging task.

- Enhancement of the proposed scheme by tuning the control parameter (e.g, by increasing α).
- Exploit TCP flow characteristics for association control. As Figs. 15 and 16 show, if TCP is transmitting at its maximum rate (i.e., at RWND), the throughput does not fluctuate with time. On the other hand, if TCP is not transmitting at its maximum rate, the throughput tends to fluctuate largely. By monitoring such characteristics, we believe that it is possible to "guess" that TCP is not transmitting at its maximum rate.
- Cross layer approach that enables direct information exchange between between Layer 4 and Layer 3.

C. Cell aggregation

We evaluate the performance of the cell aggregation technique. The testbed scenario is the same as shown in Fig. 9. Each cell has STAs with UDP traffic whose aggregate offered rate is 9 Mbps, thus congestion is not an issue. Fig. 17 shows the evaluation result. As the figure shows, upon activation of the manager (at around 30 seconds), the STAs at cells 1 and 4 are moved to cells 2 and 3, enabling AP1 and AP4 be in the power-saving mode. Although the throughput is degraded during the disconnection period, as soon as the STAs are associated with the destination APs, the network achieves its maximum throughput utilizing the half of the total number of APs.

VII. CONCLUSION

In community WLANs, APs and STAs (i.e., users) tend to concentrate on different areas. A concentration of STAs often

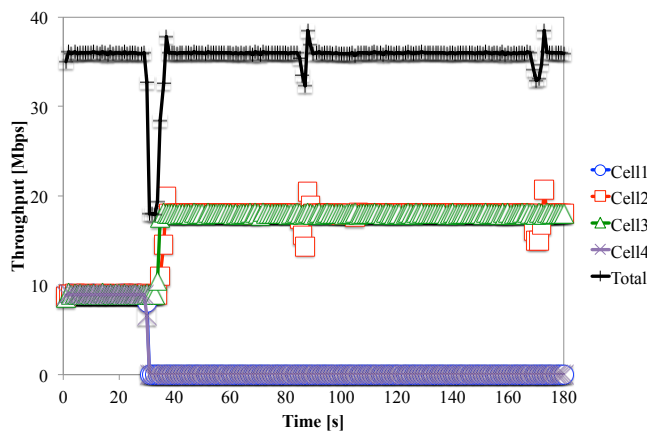

Figure 17. Throughput performance of the cell aggregation mechanism. STAs at cells 1 and 4 are moved to cells 2 and 3.

results in the APs and STAs in that particular area suffer from congestion. A concentration of APs, on the other hand, causes energy wastage. In this paper, we proposed an association control scheme that aims at maximizing throughput by congestion alleviation method and reducing energy consumption by cell aggregation method. We first analytically formulated that the throughput of a node belonging to a WLAN can be expressed as the multiplication of three components: success probability, frame transmission rate, and air-time ratio. The success probability is the probability of collision-free transmission. The frame transmission rate is the speed of the data transmission, and it is a function of the link quality. The air-time ratio is the ratio of the channel busy time to the total time. The frame transmission rate and air-time ratio can easily be monitored and estimated. The success probability, on the other hand, is a function of the number of contending nodes, which are extremely difficult to monitor in the real systems. Due to this reason, we extended our theoretical study and showed that success probability can be maximized by controlling air-time ratio. Finally, we proposed our association control scheme for throughput maximization and energy efficiency by taking account of the multiplication of frame transmission rate and air-time ratio. The performance of the proposed scheme is investigated by extensive evaluations using computer simulations and testbed experiments. Both the simulation and testbed evaluations strongly indicate the correctness of the theoretical work and the effectiveness of the proposed scheme for realistic network scenario with both UDP and TCP traffic. The testbed experiments prove that the proposed scheme and TCP can stably coexist for congestion control. We plan to further enhance the proposed scheme for improved TCP throughput. In addition to simulation and testbed evaluations, we intend to evaluate the scheme using statistical analysis. Our future work also includes a study on energy efficiency induced by the cell aggregation mechanism.

ACKNOWLEDGMENT

This research was performed under research contract of "Research and Development for Reliability Improvement by The Dynamic Utilization of Heterogeneous Radio Systems", for the Ministry of Internal Affairs and Communications, Japan.

REFERENCES

- [1] O. Shagdar, S. Tang, A. Hasegawa, T. Shibata, and S. Obana. Association Control for Throughput Maximization and Energy Efficiency for Wireless LANs. In *Emerging 2011: Proceedings of the Third International Conference on Emerging Network Intelligence*, Lisbon, Portugal, November 2011. pp. 112-117.
- [2] FON Community. <http://corp.fon.com/> (last accessed 22/12/2012).
- [3] S. Sheu and C. Wu. Dynamic load balance algorithm (dlba) for ieee 802.11 wireless lan. *Tamkang Journal of Science and Engineering*, 1999. vol. 2, no. 1, pp.45-52.
- [4] H. Velayos, V. Aleo, and G. Karlsson. Load balancing in overlapping wireless lan cells. *IEEE ICC 2004: Proceedings of International Conference on Communications*, June 2004. vol. 7, pp.3833-3836.
- [5] A. J. Jardosh, K. Papagiannaki, E. M. Belding, K. C. Almeroth, G. Iannaccone, and B. Vinnakota. Green wlan: On-demand wlan infrastructures. *Springer, Journal on Mobile Networks and Applications*, December 2009. vol. 14, issue 6, pp.798-814.
- [6] Y. Fukuda and Y. Oie. Decentralized access point selection architecture for wireless lans. *IEICE Transactions on Communications*, 2007. vol. E90-B, no. 9, pp.675-684.
- [7] F. Guo and T-C. Chiueh. Scalable and robust wlan connectivity using access point array. In *IEEE DSN 2005: Proceedings of International Conference on Dependable Systems and Networks*, July 2005. pp.288-297.
- [8] I. Jabri, N. Krommenacker, T. Divoux, and A. Soudani. Ieee 802.11 load balancing: An approach for qos enhancement. *Springer, International Journal on Wireless Information Networks*, 2008. vol. 15, pp.16-30.
- [9] G. Bianchi. Performance evaluation and enhancement of the csma/ca mac protocol for 802.11 wireless lansanalysis of the ieee 802.11 distributed coordination function. *PIMRC'96: Seventh IEEE International Symposium on Personal, Indoor and Mobile Radio Communications*, Oct 1996. vol. 2, pp.392-396.
- [10] Q. Zhao, D. H. K. Tsang, and T. Sakurai. A simple model for nonsaturated ieee 802.11 dcf networks. *IEEE Communications Letters*, September 2009. vol. 12, no. 8, pp.563-565.
- [11] IEEE Standard for Information technology Telecommunications and information exchange between systems-Local and metropolitan area networks Specific requirements Part 11: Wireless LAN Medium Access Control (MAC) and Physical Layer (PHY) Specifications, June 2007. IEEE Std 802.11-2007.
- [12] H. Zhai, X. Chen, and Y. Fang. How well can the ieee 802.11 wireless lan suport quality of service. *IEEE Transaction on Wireless Communications*, November 2005. vol. 4, no. 6, pp.3084-3094.
- [13] MadWifi. <http://madwifi-project.org/> (last accessed 22/12/2012).
- [14] I. Ramani and S. Savage. Syncscan: practical fast handoff for 802.11 infrastructure networks. *INFOCOM 2005: Proceeding of IEEE International Conference on Computer Communications*, 2005. vol. 1, pp.675-684.
- [15] S. Tang, N. Taniguchi, O. Shagdar, M. Tamai, H. Yomo, A. Hasegawa, T. Ueda, R. Miura, and S. Obana. Potential throughput based access point selection. *APCC 2010: Proceeding of IEEE Asia-Pacific Conference on Communications*, 2010. vol. 1, pp.470-475.
- [16] N. Mishra, K. Chebroulu, B. Raman, and A. Pathak. Wake-on-wlan. *WWW 2006: Proceeding of ACM International Conference on World Wide Web*, 2006. pp.761-769.
- [17] IEEE 802.11v: IEEE Standard for Information Technology Telecommunications and information exchange between systems Local and metropolitan area networks Specific requirements, Part 11: Wireless LAN Medium Access Control (MAC) and Physical Layer (PHY) specifications Amendment 8: IEEE 802.11 Wireless Network Management, February 2011. IEEE Std 802.11v-2011.
- [18] Scenargie network simulator. <http://www.spacetime-eng.com> (last accessed 22/12/2012).