



**HAL**  
open science

## Singular Perturbation Control for coordination of converters in a Fuel Cell System

Malek Ghanes, Mickaël Hilaiet, Jean-Pierre Barbot, Olivier Bethoux

► **To cite this version:**

Malek Ghanes, Mickaël Hilaiet, Jean-Pierre Barbot, Olivier Bethoux. Singular Perturbation Control for coordination of converters in a Fuel Cell System. ELECTRIMACS, Jun 2011, Cergy-Pontoise, France. hal-00752998

**HAL Id: hal-00752998**

**<https://inria.hal.science/hal-00752998>**

Submitted on 16 Nov 2012

**HAL** is a multi-disciplinary open access archive for the deposit and dissemination of scientific research documents, whether they are published or not. The documents may come from teaching and research institutions in France or abroad, or from public or private research centers.

L'archive ouverte pluridisciplinaire **HAL**, est destinée au dépôt et à la diffusion de documents scientifiques de niveau recherche, publiés ou non, émanant des établissements d'enseignement et de recherche français ou étrangers, des laboratoires publics ou privés.

# SINGULAR PERTURBATION CONTROL FOR COORDINATION OF CONVERTERS IN A FUEL CELL SYSTEM

M. Ghanes<sup>1</sup>, M. Hilaiet<sup>2</sup>, J-P. Barbot<sup>1,3</sup>, O. Bethoux<sup>2</sup>

1. ECS-Lab ENSEA, EA 3649, Cergy-Penthoise, France.

e-mail : [ghanes@ensea.fr](mailto:ghanes@ensea.fr) , [barbot@ensea.fr](mailto:barbot@ensea.fr)

2. Laboratoire de Génie Electrique de Paris (LGE) / SPEE-Labs, CNRS UMR 8507, France.

e-mail : [mickael.hilaiet@lgep.supelec.fr](mailto:mickael.hilaiet@lgep.supelec.fr) , [olivier.bethoux@lgep.supelec.fr](mailto:olivier.bethoux@lgep.supelec.fr)

3. EPI-ALIEN, INRIA, France.

**Abstract** - In this paper, the converters coordination problem of a fuel cell system involving a hydrogen fuel cell (FC) with supercapacitors (SCs) for applications with high instantaneous dynamic power is considered. A singular perturbation approach is used to solve the control problem under unknown variable load, where the convergence of the voltage controller is analyzed by using Lyapunov theory. Simulation results show the performances of the proposed approach against a significant FC-SCs benchmark.

**Keyword** - Fuel cell, supercapacitors, power management, energy-shaping, singular perturbation approach.

## 1 PROBLEM STATEMENT

In this paper we consider the problem of the power management of an hydrogen Fuel Cell (FC) system associated to a reversible impulse energy source (the supercapacitors) due to the development increasing of electric and hybrid vehicles since 2009. The FC must deliver a slowly varying current, not more than 4A/s for a 0.5kW/12.5V FC [3], and 10A/s for a 20kW/48V FC [4] as example. That is why the FC needs to be associated with other sources (here the supercapacitors) which supply short pulse energy and fill the temporary failure of the FC [1, 2, 5]. Solving the problem leads to a design challenge consisting to choose power components, to design an adapted architecture and to define the appropriate associated control strategy [8].

The parallel architecture is the most suitable structure: the components have lower stress, the management of power is easy and is more reliable [9, 10]. The parallel structure with two converters (Fig. 1) (see [12–14]), which associates a static converter with each source, allows perfect control of the power flow of each source. However, its drawbacks are the inevitable losses associated with each static converter and a higher cost. This paper is dedicated to the study of the structure with two converters shown in Fig. 1.

Three major objectives of the problem statement are the respect of FC dynamics (mainly limited by the time response of the air compressor), control of the storage device (SCs) state of charge and the power

response (positive or negative) required by the load. It means that the current delivered by the FC must have smooth behavior in order to ensure its live time, while the SCs provide the load power transient. The hybridization of the electrical supply is highly recommended to limit the dynamic effects and a special attention is also required for the shut-down and start-up procedures to preserve the fuel cell performances and enhance its durability. Therefore, it seems clear that the DC bus regulation is managed by the supercapacitors.

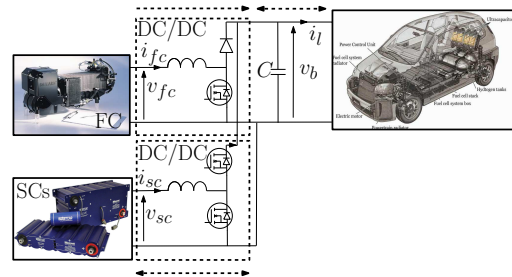

Fig. 1. Two converters parallel structure studied in this work.

To reach the objectives, high-performance controllers are readily available based on the system state [9, 17], fuzzy logic [18, 19], proportional-integral controllers [3, 11], RST controller [20], passivity [21], flatness [22, 23] or model predictive control [15].

Alternative approach exist such as optimal control

[7], dynamic programming [24] or empirical control associated with a multi objective genetic algorithm optimization [6] that has been applied for the supervisory power train control problem in charge sustaining hybrid electric vehicles. However, these approach are based on the *a priori* knowledge of the power load, thus real-time control is not straightforward implementable.

The frequency decoupling method using two cascaded loops of currents and voltages proposed in [11] allows to have :

The SCs supply power transient, while the FC supplies the mean power (This slow FC dynamics increases the system life time).

Modification of the power load induces a change in the DC bus voltage.

The gains are tuned to ensure the closed-loop system stability, although it has not been theoretically proved.

In the work of [16], a passivity based approach is adopted where the closed-loop system stability is proved. However, to overcome the difficulty of the known load, the authors have proposed to use an observer estimating the unknown resistance load or an integral action.

In this paper, a controller based on singular perturbation approach ([28, 33]) is proposed to respect the slower FC dynamics, control of the storage device (SCs) state of charge and the power response required by the load with a DC bus regulation. This solution permits to avoid the use an PI controller loop which is not very robust to load variation [11] and the use of an observer or an integral action [16]. Moreover this approach is well adapted to the problem of FC-SCs control where the FC and SCs currents must be slow and fast respectively. A stability proof of the system is given.

The remaining of the paper is organized as follows : In section II, the idea of the singular perturbation (SP) approach is applied to the Nexa Ballard fuel cell system to design the proposed controller with a stability proof. Section III reports the simulation results.

## 2 SINGULAR PERTURBATION APPROACH

The control scheme problem is to drive the load voltage under the main constraint of slow variation of fuel cell current  $i_{fc}$  and the secondary constraint of super capacitor voltage  $V_{sc}$  regulation. In order to do these a singular perturbation approach [28, 33] is used, so firstly a brief recall on such approach is recall and after that the control design of fuel cell and super capacitor system is present in this section.

### 2.1 BRIEF RECALLS ON SINGULAR PERTURBATION

Let us consider the following nonlinear system:

$$\dot{x} = f(x, z, \varepsilon) \quad (1)$$

$$\varepsilon \dot{z} = g(x, z, \varepsilon) \quad (2)$$

with  $x \in R^m$ ,  $z \in R^n$ ,  $\varepsilon$  a small positive parameter and  $f, g$  two analytical vector fields of appropriate dimension. Roughly speaking,  $x$  can be seen as the slow state and  $z$  as the fast variable. Nevertheless, this must be quickly clarified in the next and some assumptions and theoretical developments must be recalled. First of all, it is usual to decompose the system (1)-(2) in decoupled two time scales dynamic. For this, it is important to be able to compute the so-called slow manifold  $z = \phi(x, \varepsilon)$ , this manifold is the  $z$  behavior when the fast transient time is finished ("outside the boundary-layer"). The slow manifold  $\phi$  must verify the following equation:

$$\varepsilon \dot{\phi}(x, \varepsilon) = g(x, \phi(x, \varepsilon), \varepsilon) \quad (3)$$

where  $\phi(x, \varepsilon) = \sum_{i=0}^{\infty} \alpha_i(x) \frac{\varepsilon^i}{i!}$  is computed iteratively [30]. For example the so-called frozen solution verify:

$$0 = g(x, \alpha_0(x), 0)$$

Condition is requested for the  $\alpha_0$  existence:

**Assumption A.1:** The Jacobian  $\left\{ \frac{\partial g(x, z, 0)}{\partial z} \right\}$  is regular in the considered state space  $x \in D_x \in R^M$  and  $z \in D_z \in R^n$ .

This assumption is directly linked to the implicit function theorem and in nonlinear case more than one solution is possible and in this case a fold appears, this is outside the scope of this recall. Now, it is important to know if the system (1)-(2) converges on a slow manifold this is given by the well known Tikhonov's theorem [29] but before recall the theorem it is necessary to analyze the fast dynamic on the boundary-layer. For this, a new state variable  $\eta = z - \phi$  is introduced and  $\eta$  converges rapidly to zero if the system behavior converges on the slow manifold.

The  $\eta$  dynamics is equal to

$$\dot{\eta} = \frac{1}{\varepsilon} g(x, \phi(x, \varepsilon) + \eta, \varepsilon) - \frac{\partial(\phi(x, \varepsilon), \varepsilon)}{\partial t} \quad (4)$$

Setting  $\varsigma = \frac{t}{\varepsilon}$ , (4) may be rewritten

$$\frac{\partial \eta}{\partial \varsigma} = g(x, \phi(x, \varepsilon) + \eta, \varepsilon) - \varepsilon \frac{\partial(\phi(x, \varepsilon), \varepsilon)}{\partial \varsigma} \quad (5)$$

**Assumption A.2** The system (5) is locally in  $\eta$  and uniformly in  $x$  exponentially stable.

Hereafter, the Tikhonov's Theorem without considerations of time domain and existence and uniqueness of the solution (for example Lipschitz conditions are implicit).

**Theorem 2.1** Under the assumptions A.1 and A.2 and for  $\varepsilon \in R^+$  sufficiently small, after a transient  $t_1$  the dynamics (1)-(2) evolves on a slow dynamic and his dynamic is equal to:

$$\dot{x} = g(x, \phi(x), \varepsilon) \quad (6)$$

In many applications, (6) is approximated at first order (the frozen solution of  $\phi$ )

$$\dot{x} = g(x, \alpha_0(x), 0) \quad (7)$$

As in the considered application the dynamics are too dynamically closed, some fast actuators (high-gain feedback) are used [31].

Considering, for the seek of simplicity, the following dynamical system

$$\dot{\chi} = \tilde{f}(\chi, \zeta) \quad (8)$$

$$\dot{\zeta} = \tilde{g}(\chi, \zeta) + \tilde{\beta}(\chi)u \quad (9)$$

with  $\chi \in R^m$ ,  $\zeta \in R^n$ ,  $u \in R^n$  and  $\tilde{\beta}$  regular for all  $\chi$ . Then setting, for example  $u = -\frac{1}{\varepsilon}\tilde{\beta}(\chi)^{-1}(\zeta - \alpha_0(\chi))$  the dynamic become:

$$\dot{\chi} = f(\chi, \zeta) \quad (10)$$

$$\varepsilon\dot{\zeta} = \varepsilon\tilde{g}(\chi, \zeta) - (\zeta - \alpha_0(\chi)) \quad (11)$$

Dynamics (10)-(11) are similar to the dynamics (1)-(2), thus, it is possible to use the theorem 2.1 and the slow dynamic of (10)-(11) in first approximation is equal to

$$\dot{\chi} = f(\chi, \alpha_0(\chi)) \quad (12)$$

**Remark 2.1** In this paper, we often restrict our purpose to the first approximation of the slow manifold i.e.  $\phi \simeq \alpha_0(x)$ , nevertheless, for example, when the system behavior is too closed to a fold it is necessary to do a better  $\phi$ 's approximation.

## 2.2 FUEL CELL-SUPERCAPACITORS MODELS

### 2.2.1 Power electronic's modeling

In this paper, the modeling of the various elements is the same as in numerous studies [20, 21].

**Fuel cell modeling** The model used is a static model [25–27] where the FC voltage  $v_{fc}$  is computed according to the current stack  $i_{fc}$  by a 5<sup>th</sup> order polynomial function of the stack current  $i_{fc}$  as shown in Fig. 2, in order to improve the simulation time and used a simple equation without loss of accuracy.

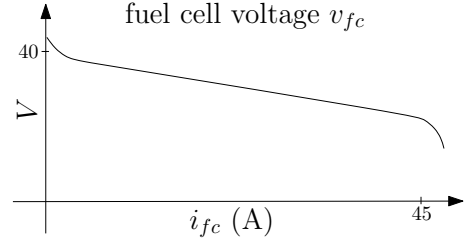

Fig. 2. Fuel cell voltage vs current.

**FC boost converter** To use the FC system in an electric power system, the FC must be connected the FC to a fixed DC bus voltage. In this case, the FC voltage must be increased, because it is often less than the DC bus voltage. The boost converter represented in Fig. (3) is controlled by binary input  $w_1(t)$ .

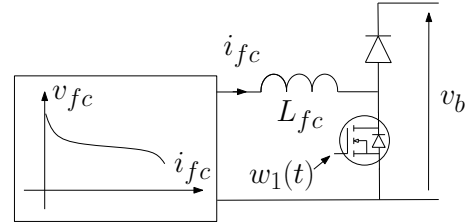

Fig. 3. Boost converter.

Defining  $\alpha_1$  as the duty cycle of control variable  $w_1(t)$ , this subsystem can be represented by its average model (here, the switches are regarded as ideal):

$$\begin{aligned} \frac{di_{fc}}{dt} &= \frac{1}{L_{fc}}(- (1 - \alpha_1) v_b + v_{fc}) \\ \frac{dv_b}{dt} &= \frac{1}{C}((1 - \alpha_1) i_{fc} - i_l) \end{aligned} \quad (13)$$

where  $v_b$  is the DC link voltage,  $v_{fc}$  is the FC voltage,  $i_l$  is the DC current delivered to the load and  $i_{fc}$  is the FC current.

The product between control input  $\alpha_1$  and state variable  $v_b$  shows a non-linear behaviour of the converter.

**SCs boost converter** SCs can be charged or discharged; therefore the storage elements are connected to the DC bus through a reversible power converter.

The SCs used here have a constant capacity ( $C_{sc}$ ) and negligible losses. They are associated with an inductance ( $L_{sc}$ ) and a boost converter as shown in Fig. (4). Two types of operations are possible : a buck operating mode when SCs receive energy from the DC bus, and a boost operating mode when SCs supply energy to the DC bus.

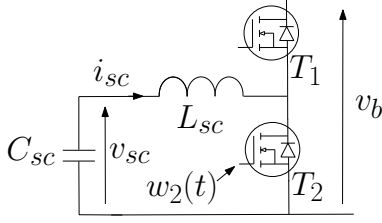

Fig. 4. Boost converter.

We define  $\alpha_2$  as the duty cycle of control variable  $w_2(t)$ . The second sub-system is represented by an average model as follows:

$$\begin{aligned} \frac{di_{sc}}{dt} &= \frac{1}{L_{sc}} \left( -(1 - \alpha_2) v_b + v_{sc} \right) \\ \frac{dv_{sc}}{dt} &= -\frac{i_{sc}}{C_{sc}} \end{aligned} \quad (14)$$

**DC bus and load model** Fig. (5) shows the model of the DC bus and the load. In our work, the load is modeled by a  $(R_l L_l)$  circuit, whose resistance value  $R_l$  varies according to the power required by the load.  $E_l$  represents the electromotive force of an electrical machine. When the electric load operates as a generator, this electromotive force (e.m.f.,  $E_l$ ) is positive. The average model is:

$$\begin{aligned} \frac{dv_b}{dt} &= \frac{1}{C} \left( (1 - \alpha_1) i_{fc} + (1 - \alpha_2) i_{sc} - i_l \right) \\ \frac{di_l}{dt} &= \frac{1}{L_l} \left( -R_l i_l + v_b \right) \end{aligned} \quad (15)$$

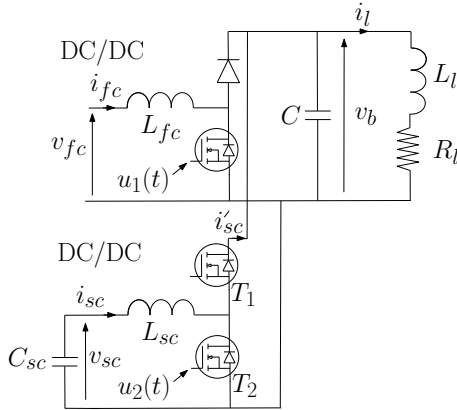

Fig. 5. DC bus and load model.

### 2.2.2 Two time scales complete model

**Complete model** It follows that the complete “fuel cell -supercapacitors” system is represented by the 5<sup>th</sup> order non-linear state space model :

$$\begin{aligned} \dot{x}_1 &= \frac{(1-\alpha_1)x_4 + (1-\alpha_2)x_5 - x_3}{C} \\ \dot{x}_2 &= -\frac{x_5}{C_{sc}} \\ \dot{x}_3 &= \frac{-R_l x_3 + x_1}{L_l} \\ \dot{x}_4 &= \frac{-(1-\alpha_1)x_1 + z}{L_{fc}} \\ \dot{x}_5 &= \frac{-(1-\alpha_2)x_1 + x_2}{L_{sc}} \end{aligned} \quad (16)$$

with state space  $x(t) = [x_1; x_2; x_3; x_4; x_5]^t = [v_b; v_{sc}; i_l; i_{fc}; i_{sc}]^t$ , control inputs  $u(t) = [u_1; u_2]^t = [1 - \alpha_1; 1 - \alpha_2]^t$ , measures  $y(t) = x$  and  $z(t) = v_{fc}$ , and electromotive force  $E_l$  as a perturbation ( $d$ ). At this model, it is applied, similarly to [31] and as it is recalled in the previous section two fast actuators. This fast actuators are two PI controllers which assign respectively  $I_{fc}$  and  $I_{sc}$  to a desired value  $I_{fc}^*$  and  $I_{sc}^*$ . Here, the dynamics of both PI are chosen such that assumptions A.1-A.2 are verified and outside the boundary-layer the dynamic is on the slow manifold and the system behavior is given by equation (7).

### 2.2.3 Slow reduced model

In order to present the slow reduced dynamics (16) in input-state representation  $I_{fc}^*$  is considered as the input  $u_1$  and  $I_{sc}^*$  as the input  $u_2$  and from (7) the reduced slow system is given by:

$$\begin{aligned} \dot{x}_1 &= \frac{1}{C} \left( \frac{z_3}{x_1} u_1 + \frac{x_2}{x_1} u_2 - x_3 \right) \\ \dot{x}_2 &= -\frac{u_2}{C_{sc}} \\ \dot{x}_3 &= \frac{-R_l x_3 + x_1}{L_l} \end{aligned} \quad (17)$$

with  $x = [x_1; x_2; x_3]^t = [v_b; v_{sc}; i_l]^t$ ; control inputs  $u = [u_1; u_2]^t = [i_{fc}; i_{sc}]^t$ , measures  $y = [v_b; v_{sc}; i_l]^t$  and  $z = [i_{fc}; i_{sc}; v_{fc}]^t$ . It is important to note that the model (17) is valid only if all its closed loop dynamic are slower than the dynamic of the fast actuator, here the PI controller which assign the current  $I_{fc}$  and  $I_{sc}$ , this will be a constrain in the design of the slow controllers.

## 2.3 SLOW CONTROL DESIGN

The desired equilibrium point are the following one  $x^* = [v_b^*; v_{sc}^*; \frac{v_b^*}{R_l}]^t$ , with  $v_b^*$  and  $v_{sc}^*$  the DC bus and SCs desired voltages. As the constraint on  $I_{fc}$  is such that its dynamic must be very slow (i.e.  $\frac{dI_{fc}}{dt} < 4As^{-1}$ )  $u_1$  is considered as a slow input and has only a slow effect on the convergence of the dynamic (17). Consequently the gain on the  $u_1$  loop must be very small and the variation of the component of  $u_1$  must be filtered directly or implicitly. From these considerations  $u_1$  is designed as follow

$$u_1 = I_{lm} - \frac{C_{cs}}{T} e_{sc} \quad (18)$$

Where  $I_{lm}$  is an average of the current in the load (in reality a load's current filtered with a low pass filter). Moreover,  $e_{sc} = V_{sc} - V_{sc}^*$  and  $T$  are chosen in order that the feedback on  $e_{sc}$  will be also sufficiently slow. Here it is important to note that  $e_{sc}$  is not filtered because  $V_{sc}^*$  is a constant and  $V_{sc}$  is proportional to the  $I_{sc}$  integral and then implicitly filtered. Now, as  $u_1$  is a slow input the second input

$u_2$  can be faster than  $u_1$  but slower than the current loops driven by both PI fast actuators, so  $u_2$  is:

$$u_2 = \frac{x_1}{x_2} \left[ \frac{C}{\tau} e_b - \frac{z_3}{x_1} \left( I_{lm} - \frac{C_{cs}}{T} e_{sc} \right) + x_3 \right] \quad (19)$$

with  $e_b = V_b - V_b^*$  and  $\tau$  is chosen in order that the feedback on  $e_b$  is slower than both PI fast actuators but faster than the loop on  $e_{sc}$ . From (18) and (19), it is possible to set the following proposition.

**Proposition 2.1** *The system (17) under the controls (18) and (19) is locally exponentially stable for  $V_b^*$  and  $V_{sc}^*$  constants with a bias on  $x_2 = V_{sc}$ .*

**Proof 2.1** *Choosing the following Lyapunov function  $V_T = V_1 + V_2 + V_3$  with  $V_1 = 0.5(x_3 - i_{lm})^2$ ,  $V_2 = 0.5e_b^2$  and  $V_3 = 0.5e_{sc}^2$ , the differentiation of  $V_2$  gives:*

$$\dot{V}_2 = -\frac{e_b^2}{\tau}$$

Consequently  $e_b$  converges exponentially to zero uniformly with respect to  $e_{sc}$  and  $e_{sc}$ . The differentiation of  $V_1$  is equal to:

$$\dot{V}_1 = (x_3 - i_{lm}) \frac{-R_l x_3 + x_1}{L_l}$$

Setting  $e_i = x_3 - i_{lm}$  and the fact that  $i_{lm} = V_b^*/R_l$  one has

$$\dot{V}_1 = e_i \frac{-R_l e_i + e_b}{L_l}$$

as  $e_b$  converge to zero independently of  $e_i$  then  $e_i$  also converges exponentially to zero and this uniformly with respect to  $e_{sc}$ . Finally  $V_3$  gives:

$$\dot{V}_3 = -e_{sc} \left( \frac{x_1}{x_2} \left[ \frac{C}{\tau} e_b - \frac{z_3}{x_1} \left( I_{lm} - \frac{C_{cs}}{T} e_{sc} \right) + x_3 \right] \right) \frac{1}{C_{cs}}$$

Since  $e_b$  converges to zero and  $x_3$  to  $i_{lm}$ , then after such convergence one has

$$\dot{V}_3 = -\frac{e_{sc}}{C_{cs}} \left( \frac{z_3}{x_2} \frac{C_{cs}}{T} e_{sc} - \frac{z_3}{x_2} I_{lm} + \frac{x_1}{x_2} I_{lm} \right)$$

Which is locally exponentially stable for  $x_2 > 0$ , with a bias convergence of  $e_{sc}$  to  $\frac{(z_3 - x_1) I_{lm} T}{C_{cs} z_3}$ . Moreover  $T$  must be chosen in order that the dynamic of  $e_{sc}$  is slower with respect to PI fast actuators.

**Remark 2.2** *It is important to note that the bias may be canceled by adding an adaptive skim. This will be done in a future work. Moreover due to practical implementation, the control is digital and some problems appear ([32], [34]).*

### 3 SIMULATION RESULTS

To test and validate the performances of the proposed FC controller (18-19), a dedicated FC Control Benchmark is proposed by Fig. (6) where the reference DC bus voltage is set equal to 48V and the load current varies between 4.8 and 15A. This power cycle is representative of a vehicle power demand, where the load requirement consists in raising and lowering power edges between 240 and 720W.

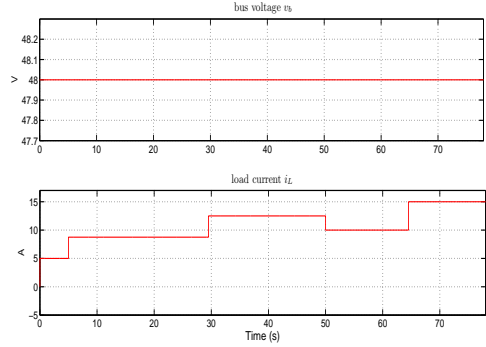

Fig. 6. Fuel Cell Control Benchmark.

Concerning the load, the proposed FC controller uses only the measurement of load current while the load is an unknown variable.

The block diagram scheme of the proposed controller adopted in this work and used in simulation is given by Fig. 7. It is composed of three subsystems : one fast actuator for the FC based on a PI controller, second actuator to manage the current of the SCs based on a IP controller, and the proposed singular perturbation approach to control the DC bus voltage and state of charge of the SCs.

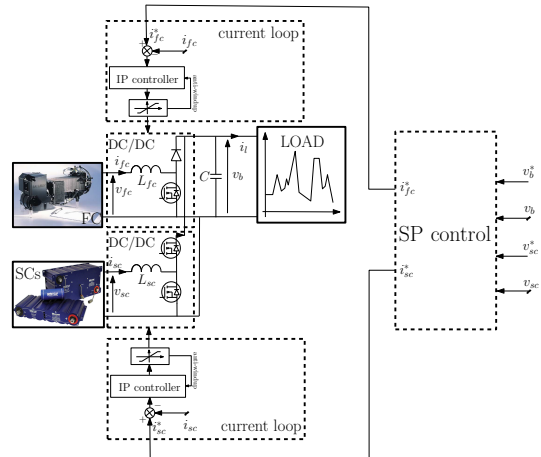

Fig. 7. Singular Perturbation structure.

Fig. (8) shows the response of the FC hybrid system according to the reference trajectories of the Benchmark (Fig. 6). It can be remarked that a very good tracking of the DC bus (Fig. 8.a) is ensured by the proposed fast controller (19) with a smooth response of the FC current<sup>1</sup> (Fig. 8.e) during fast power demands of the load (Fig. 8.c) so as to maintain the FC state of health. Moreover, the energy balance is well achieved, characterized by a SC voltage (Fig. 8.b)) value reaching the desired set point (24V) at steady state by the proposed slow controller (18).

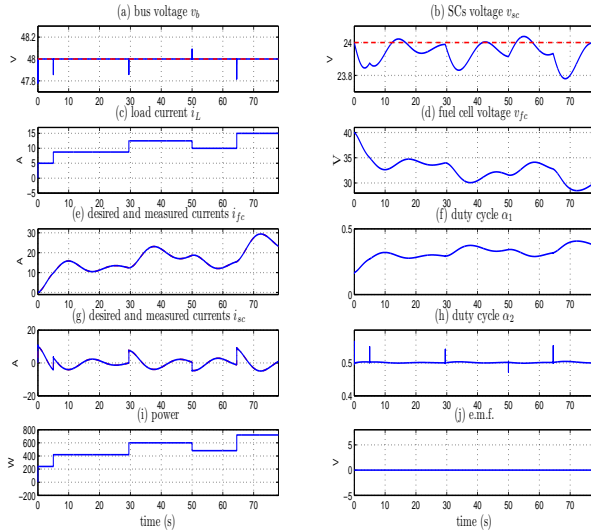

Fig. 8. Simulation result with an unknown load.

**Acknowledgment** This research was supported by the PEPS project "GESE : Gestion Echantillonnée des Systèmes Energétiques", 2010.

#### 4. REFERENCES

[1] A.F. Burke, "Batteries and ultracapacitors for electric, hybrid, and fuel cell vehicles," *Proceedings of the IEEE*, Vol. 95, no 4, pp. 806-820, April 2007.

[2] J. Larminie, A. Dicks, "Fuel cell systems explained," John Wiley & Sons Ltd, second edition, ISBN 0-470-84857-X, 2003.

[3] P. Thounthong, S. Raël, B. Davat, "Energy management of fuel cell/battery/supercapacitor hybrid power source for vehicle applications," *Journal of Power Sources*, Vol. 193, Issue 1, pp. 376-385, Agu. 2009.

[4] P. Corbo, F. Migliardina, O. Veneri, "PEFC stacks as power sources for hybrid propulsion

<sup>1</sup>The FC rate of change is nearly equal to 4A/s (or 10A/s, as for an FC example given by [3, 4])

systems," *International Journal of Hydrogen Energy*, Vol. 34, Issue 10, pp. 4635-4644, May 2009

[5] D. Hissel, C. Turpin, S. Astier, L. Boulon, et al, "A review on existing modeling methodologies for PEM fuel cell systems," *Fundamentals and developments of fuel cells conference*, FDFC, 2008.

[6] V. Paladini, T. Donato, A. de Risi, D. Laforgia, "Super-capacitors fuel-cell hybrid electric vehicle optimization and control strategy development," *Energy Conversion and Management*, Vol. 48, no 11, pp. 3001-3008, Nov. 2007.

[7] P. Rodatz, G. Paganelli, A. Sciarretta, L. Guzzella, "Optimal power management of an experimental fuel cell/supercapacitor-powered hybrid vehicle," *Control Engineering Practice*, Vol. 13, no 1, pp. 41-53, Jan. 2005.

[8] P. Thounthong, S. Raël, B. Davat, "Supercapacitors as an energy storage for fuel cell automotive hybrid electrical system," *IEEE Industrial Electronics Magazine*, Vol. 3, no. 1, Mar. 2009.

[9] Z. Jiang, L. Gao, M.J. Blackwelder, R.A. Dougal, "Design and experimental tests of control strategies for active hybrid fuel cell/battery power sources," *Journal of Power Sources*, Vol. 130, pp. 163-171, 2004.

[10] M. Cacciato, F. Caricchi, F. Giuhlii, E. Santini, "A critical evaluation and design of bi-directional DC/DC converters for supercapacitors interfacing in fuel cell applications," *IEEE Industry Applications Conference*, IEEE IAS 2004, Vol. 2, pp. 1127-1133, Oct. 2004.

[11] T. Azib, O. Bethoux, G. Remy, C. Marchand, "Structure and Control Strategy for a Parallel Hybrid Fuel Cell/Supercapacitors Power Source," *IEEE VPPC'09* in Dearborn, Michigan, Sept 7-11. 2009.

[12] M. Cacciato, F. Caricchi, F. Giuhlii, E. Santini, "A critical evaluation and design of bi-directional DC/DC converters for supercapacitors interfacing in fuel cell applications," *IEEE Industry Applications Conf.*, IEEE IAS'04, Vol.2, pp. 1127-1133, Oct. 2004.

[13] F. Giulii, M. Cacciato, "Using Super Capacitors in combination with Bi-Directional DC/DC Converters for Active Load. Management in Residential Fuel Cell Applications," *1st European. Symposium on Supercapacitors*, IEEE-ESSCAP'04, 2004.

- [14] P. Thounthong, S. Raël, B. Davat, "Supercapacitors as an energy storage for fuel cell automotive hybrid electrical system," *International Journal of Electrical Engineering in Transportation*, Vol.1, No.1, 2005.
- [15] A. Vahidi, A. Stefanopoulou, H. Peng, "Current management in a hybrid fuel cell power system : a model-predictive control approach," *IEEE Transactions on Control Systems Technology*, vol. 14, no 6, Nov. 2006.
- [16] R. Talj, R. Ortega, M. Hilaret, "A controller tuning methodology for the air supply system of a PEM fuel-cell system with guaranteed stability properties," *International Journal of Control*, Vol. 82, Issue 9, pp. 1706-1719, Sep. 2009.
- [17] Z. Jiang, R.A. Dougal, "A compact digitally controlled fuel cell/battery hybrid power source," *IEEE Transactions on Industrial Electronics*, Vol. 53, no 4, Aug. 2006.
- [18] A. Hajizadeh, M. Aliakbar Golkar, "Intelligent power management strategy of hybrid distributed generation system," *Electrical power and energy systems*, Vol. 29, pp. 783-795, 2007.
- [19] M.C. Kisacikoglu, M. Uzunoglu, M.S. Alam, "Load sharing using fuzzy logic control in a fuel cell/ultracapacitor hybrid vehicle," *International Journal of Hydrogen Energy*, Vol. 34, pp. 1497-1507, 2009.
- [20] S. Caux, J. Lachaize, M. Fadel, P. Shott, L. Nicod, "Modelling and control of a Fuel Cell System and Storage Elements in transport applications," *Elsevier, Journal of Process Control*, Vol. 15, pp.481-491, 2005.
- [21] M. Becherif, "Passivity-based control of hybrid sources : fuel cell and battery," 11<sup>th</sup> *IFAC Symposium on Control in Transportation Systems*, The Netherlands, 2006.
- [22] A. Payman, S. Pierfederici, D. Arab-Khaburi, F. Meibody-Tabar, "Flatness based control of a hybrid system using a supercapacitor as an energy-storage device and a fuel cell as the main power source," *IEEE Industrial Electronics Conference, IECON*, pp. 207-212, Nov. 2006.
- [23] A. Payman, S. Pierfederici, F. Meibody-Tabar, "Energy control of supercapacitor/fuel cell hybrid power source," *Energy conversion and management*, Vol. 49, pp. 1637-1644, 2008.
- [24] A. Brahma, Y. Guezennec, G. Rizzoni, "Optimal energy management in series hybrid electric vehicles," *American Control Conference*, Vol. 1, no 6, pp. 60-64, 2000.
- [25] J.C. Amphlett, R.M. Baumert, R.F. Mann, B.A. Peppley, P.R. Roberge, "Performance modeling of the Ballard Mark IV solid polymer electrolyte fuel cell," *Journal of Electrochemical*, 142(1), pp. 9-15, 1995.
- [26] J.T. Pukrushpan, H. Peng, A.G. Stefanopoulou, "control-oriented modeling and analysis for automotive fuel cell systems," *Transactions on ASME*, Vol. 26, pp. 14-25, Mar. 2004.
- [27] W.H. Zhu , R.U. Payne , D.R. Cahela, B.J. Tatarchuk, "Uniformity analysis at MEA and stack Levels for a Nexa PEM fuel cell system," *Journal of Power Sources*, Vol. 128, no 2, pp. 231-238, Apr. 2004.
- [28] P.V. Kokotovic, H.K. Khalil and J. O'Reilly, *Singular Perturbation Methods in control: Analysis and design*. Academic Press, New York, 1986.
- [29] A.N. Tikhonov, A.B. Vasil'eva and V.M. Volosov, *Ordinary differential equations*. In E. Roubine, editor, *Mathematics Applied to Physics*, pp 162-228, Springer-Verlag New York 1970.
- [30] A.B. Vasil'eva, Asymptotic behavior of solutions to certain problems involving nonlinear differential equations containing a small parameter multiplying the highest derivatives, *Russian Math. Surveys* 18, pp 13-18, 1963.
- [31] R. Marino, High-gain feedback in non-linear control systems, *International Journal of Control*. Vol. 42, pp. 1369-1385. Dec. 1985.
- [32] F. Triefensee, M. Hilaret, D. Normand-Cyrot, O. Bethoux, Sampled-data energetic management of a fuel cell/capacitor system, *Proc. IEEE-VPPC-Vehicle Power and Propulsion Conference*, Lille; 2010.
- [33] H. Khalil, *Nonlinear systems*, 2nd edition, *Printice-Hall*, Upper-Saddle River, 1996.
- [34] J.P. Barbot, M. Djemai, S. Monaco and D. Normand-Cyrot, Analysis and control of non-linear singularly perturbed systems under sampling. *Control and Dynamics Systems*, vol. 79, pp 203-246, 1996.
- [35] E. Shchepakina, V. Sobolev, Integral manifolds, canards and black swans, *Nonlinear Analysis* 44 (2001) 897-908.



- [36] V. Arnold, A. Varchenko, and S. M Gusein-Zade, Singularités des applications différentiables, *Edition Mir*, Moscou, 1986.