



**HAL**  
open science

# Modularity, adaptability and evolution in the AUTOPIA architecture for control of autonomous vehicles.

## Updating Mechatronics of Automatic Cars

Joshué Pérez Rastelli, Carlos González, Vicente Milanés, Enrique Onieva, Jorge Godoy, Teresa de Pedro

### ► To cite this version:

Joshué Pérez Rastelli, Carlos González, Vicente Milanés, Enrique Onieva, Jorge Godoy, et al.. Modularity, adaptability and evolution in the AUTOPIA architecture for control of autonomous vehicles. Updating Mechatronics of Automatic Cars. IEEE International Conference on Mechatronics, Apr 2009, Malaga, Spain. hal-00738072

**HAL Id: hal-00738072**

**<https://inria.hal.science/hal-00738072>**

Submitted on 3 Oct 2012

**HAL** is a multi-disciplinary open access archive for the deposit and dissemination of scientific research documents, whether they are published or not. The documents may come from teaching and research institutions in France or abroad, or from public or private research centers.

L'archive ouverte pluridisciplinaire **HAL**, est destinée au dépôt et à la diffusion de documents scientifiques de niveau recherche, publiés ou non, émanant des établissements d'enseignement et de recherche français ou étrangers, des laboratoires publics ou privés.

# Modularity, adaptability and evolution in the AUTOPIA architecture for control of autonomous vehicles

## Updating Mechatronics of Automatic Cars

Joshué Pérez , Carlos González, Vicente Milanés, Enrique Onieva,  
Jorge Godoy, Teresa de Pedro  
Instituto de Automática Industrial, CSIC  
Arganda del Rey. Madrid, Spain  
{jperez, gonzalez, vmilanes, onieva, jlgodoy, tere}@iai.csic.es

**Abstract** □ Computer systems to carry out control algorithms on autonomous vehicles have been developed in recent years. However, the advances in peripheral devices allow connecting the actuator controllers to the control system by means of standard communication links (USB, CAN, Ethernet □). The goal is to permit the use of standard computers. In this paper, we present the evolution of AUTOPIA architecture and its modularity and adaptability to move the old system based on ISA controller cards to a new system with Ethernet and CAN connected controllers. The results show a comparison between both systems and the improved performance of the new system.

**Index Terms** □ Autonomous vehicle, actuator controller, global positioning, modularity system, auto motion.

### INTRODUCTION

Autonomous vehicles able to take decision to mimic the human behavior constitute a utopian goal in our days. Nevertheless, significant advances in this field have been made in the last decade [1].

When it comes to automate a vehicle, one of the most important steps are the automation of the actuators. The control of the steering wheel is the lateral control, and the brake join with throttle pedal constitute the longitudinal one. Both systems are controlled with DC motors. The more restrictive parameter is, to our knowledge, the limited voltage supply that can be demanded in a vehicle. This reason forces to reach a relative big current.

To solve this problem have been developed different systems. Joshi [2] uses a battery able to supply 42 volts to a control unit with an ISA system to manage the motor. Hori [3] utilize inverters and extra batteries put in the trunk of car to control four motors of 36 kW by means of an on-board PC. Rong [4] uses two motors to control the steering and the brake by means of a control system.

In the last ten years the AUTOPIA group has been working in the development and control of autonomous vehicles, mainly based in fuzzy logic and GPS system, with the philosophy to modify as little as possible the environment and the infrastructure previously achieved. At the beginning, the system was hosted on an industrial PC, based in a backplane with Bus ISA and control motor cards.

The architecture of the system lost some of the scalability with which it was conceived at the beginning due to several applications that perform different maneuvers, also due to the inclusion of some changes made in order to improve the cooperation with other research teams, and finally, the urgency to meet deadlines in different phases of the project.

Due to these reasons it became necessary to reorganize both hardware and software architecture. Other technologies can be selected, but using a standard computer makes easy the developments in the researching. Modern controller can be linked to the computer via standard communication links (Ethernet, USB, Blue Tooth, serial lines □), making the system more portable.

The purpose of the software reorganization was to increase its modularity, so cooperation with other partners can be achieved at different levels with a minimum interference. Thus the AUTOPIA modularity will permit to interface with the car at the physical controller level, at the fuzzy controller output level or at the fuzzy controller input level. Moreover, separating the different control levels, it is possible to access the system in the each one of the control stages: perception, decision and action. Finally, a portable version of the system, with the only function of monitoring car behavior, has been developed. This version permits the communication of a manually driven vehicle with others, either autonomous or not.

This paper is organized as follows. In section II, the vehicle equipment is described in three subsections, the old architecture, and the new one in two phases of development. Next, Section III includes some experiments that have been carried out. Finally some remarks are included in section IV.

## II. VEHICLE EQUIPMENT AND ENVIRONMENT

Departing from the IAI experience in mobile robots and fuzzy logic control, the AUTOPIA program was set up eleven years ago. In this time it has developed three autonomous vehicles, two Citroën Berlingo vans and a Citroën Pluriel C3. First the Berlingo vans were instrumented, later the Pluriel C3. A fourth vehicle, not instrumented, can be used for maneuvers in which interaction among automatic cars and manually driven cars is desired. The vans are electrically powered. Their control architecture is shown in Figure 1. We can observe that the main environment perception sensor is the RTK DGPS (GPS). To automate the steering, a computer controlled motor geared to the steering bar has been added [5]. The accelerator generates a signal between 0 to 5 volts, this signal, in automatic mode, is mimicked by the computer using a special card which also measures the speed by looking at the pulse train of the car tachometer [6].

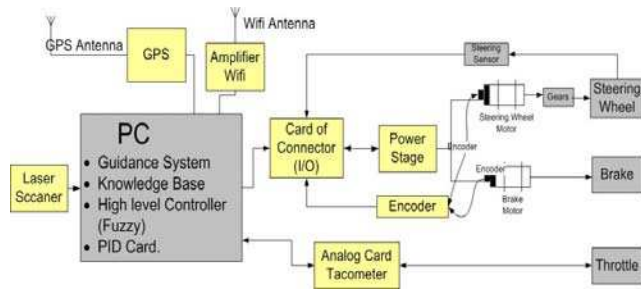

Figure 1. Architecture of the Vans

The C3 Pluriel is propelled by a gasoline motor and due to the use of new technologies in the commercial vehicles, the control architecture of the C3 can be simpler than the shown in the figure 1. Next we detailed the differences between the vans architecture and the C3 one. The presence of the bus CAN allows to read the current velocity, among others parameters. The electric power steering allows to profit the motor of this power steering to the automatic steering control. The accelerator generates two analogical signals which are mimicked by the computer. The computer braking procedure has been implemented by adding a brake circuit connected to an electro hydraulic pump. Moreover, an inertial measurement unit (IMU) has been added to provide for GPS signal loss [7].

In the last years the modularity of the system has been tested. First guiding system was based in GPS, artificial vision for obstacle detection was added next [8] and the integration of the vision device, developed by another research team, was done with very little effort. After that, in general terms, the problem of autonomous conduction could be considered solved. Presently we are looking into cooperation among different types of cars, as many projects at European level [9] [10], dealing in communication and interaction among vehicles, obstacles and infrastructure.

In the AUTOPIA program, many maneuvers between two vehicles have been tested with successful result. The ACC is solved as much at regular speeds [11] as at low speed. Other kind of maneuvers, like overtaking [12] and corner intersection traffic were simulated first and after implemented [13]. Currently, we are working in maneuvers that include more vehicles, making communication to abort the overtaking and others risky [14] maneuvers.

### A-The Van original Control System

In the old architecture of the vans (Figure 1) the onboard computer was an industrial PC with a backplane based in a bus ISA, which was the safest and with the best bandwidth, when the project began. The 16 Mbit/s that it uses is little in comparison with other modern buses, reason for which this bus is considered outdated at present.

The PC hosted both, high and low level controllers [15], but in different racks on the backplane. In the main program were the guidance system, the knowledge base, and the fuzzy controller, based in the ORBEX (Experimental Fuzzy Computer) [16]. The low level control, based in a PID card communicated with the main program through the bus ISA, controlled the steering wheel and the brake. As a power amplifier stage was needed, it was connected to the PC through an I/O card, which, in addition, was used to receive the incremental signal from the encoders and the end race sensor of the steering, as show the diagram.

For the throttle, we use a card to decode the speed, directly from the tachometer pulse train, and to establish the analogical value corresponding to the desired level of pushing in the throttle pedal.

Although the software was designed in a structured and portable way [6], it lost some of its modularity for the sake of expediency along the life of the project.

The execution average time of the control loop with this system was of the 24 ms [14]. This time is quick enough to guarantee the real time operation, because the GPS, which we also use as a real time clock, sends its data every 100ms (10 Hz), but with a new computer, a new generation devices and purifying the code this time was expected to improve.

### B- The New Van Control System

Nowadays, AUTOPIA program is starting to work with PC embedded control systems and it is attempting to use normal computers with the control systems connected as peripherals, but always taking into account the robustness of the system (i.e including anti vibration components). With this design we fulfill two goals, first to decrease the costs, because

normal computer are cheap, and second to gain independence of the computer technology and operating system.

The main requirement for designing the new system is modularity, hardware as well as software; moreover we want to separate actuation stage from the motoring and control stage. This requires that all the actuation peripherals (motors and accelerator) must be isolated, so acting can be suppressed if monitoring (the other operation mode) is the only operation desired.

In a first phase, the old industrial PC was included as part of the motor control stage, so the old PID control ISA card could still be used. For this, an interface has been programmed to communicate, through Ethernet wire, with a main PC. This new PC hosts the guidance system, the knowledge base and the fuzzy control. Thus, now we have the levels of control separated in hardware and software.

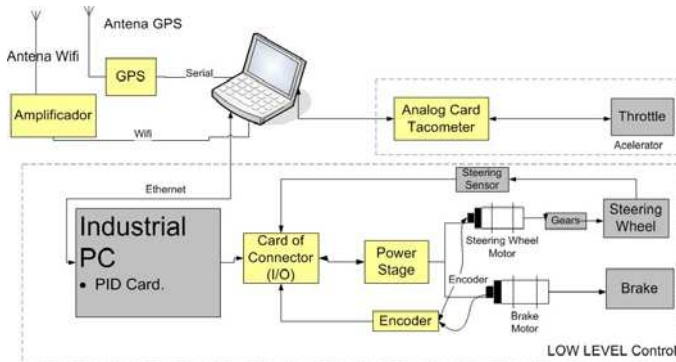

**Figure 2. New Architecture of the vans.**

The Figure 2 shows the architecture implemented in the first phase, where the second computer is represented in the grey box. However this box represents a classical close loop inner motor control. In parallel with previous developments a task was initiated to substitute a motor control device.

The separation of the low level control stage permits further developments. In effect, a new controller generation allowing power motor control via Ethernet exits and, thanks to the new architecture, the old computer and its external power card can be exchanged by a single module. In a second phase, we install a new generation motor controller for the steering wheel. This is a discrete PID, which allows to change the old power stage, and has other advantages: it is small, its power is 120 watt (10 Amp, enough for the motor) and uses a port RJ45 to communicate with the main PC.

The Figure 3 shows the second and final architecture of the vans. The acceleration is controlled in the same way. To complete the redesign we have been trying in to put a new brake system, with a computer controlled electro hydraulic brake.

The new PID has to be tuned, so first we had to estimate the system. Through an open loop estimation and using the *ident* tool of Matlab, was acquired the second order transfer function:

$$H(s) = \frac{0.8154 * e^{-j0.5}}{(S + 3.8913)(S + 3.9377)} \quad (1)$$

After, by Ziegler Nichols rules, we obtain the PID gains, and fit experimentally the fuzzy control to obtain a soft change of the steering of the vehicle.

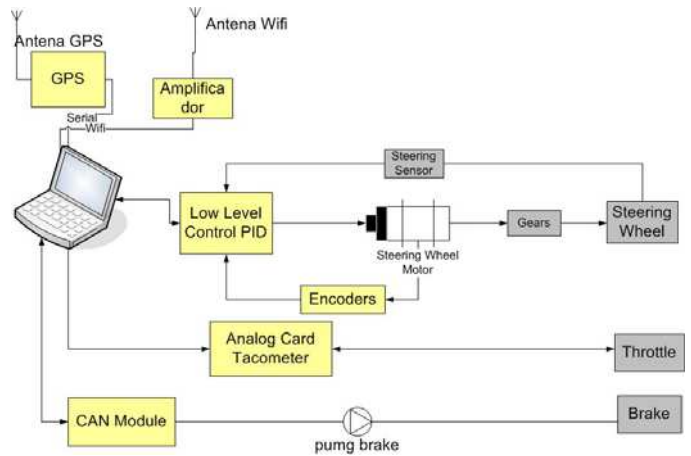

**Figure 3. Definitive Control Diagram.**

Finally it is interesting to note that the modularity of the system allows to integrate new devices in the software of control, doing a simple definition of the variables.

### C-Manually Driven Vehicle Instrumentation.

With the intention to bridge the gap between autonomous vehicles and manually driven vehicles, we have installed in a Citroen C3 a laptop with a Wifi and GPS antenna Figure 4. The goal is to permit the cooperation between these types of vehicles. For some of the cooperative maneuvers it is not necessary that all the vehicles be autonomous [11] [12]. In fact the automatic vehicles can execute the maneuvers if they know the other vehicles position and speed. For this, we have included in the control system a new operation mode, called monitor. The monitor mode has been implemented in Platero, a vehicle manually driven.

This operation mode is for monitoring the variables of the control system, showing the target location (UTM) and velocity (Km/h). Both data are given by the GPS, through the VTG frame, thus not needing to access vehicle data (CAN or the tachometer). The variables are saved and sent to other vehicles in the environment.





Figure 4. Equipment of Platero.

### III-EXPERIMENTS

The Control diagrams previously have been tested in the Citroen Berlingo Vans. The experiments show the performance of the system in the new van control. In Figure 5 we can see a route done in ZOCO, our own private urban area at the IAI facilities. The experiments consist on moving along a path with six straight segments and six bends. The first three bends are to the left and the next ones to the right, almost all have about 90 degrees, but some are more pronounced than others. Those conditions are excellent for testing the control system, mainly the steering control.

The blue plot refers to the map that the vehicle tries to follow. The actual covered path data come from the onboard GPS, which have its antenna in the middle of the rear axle in the car. The red plot is the route than the vehicle actually does. This begins next to the central corner in ZOCO.

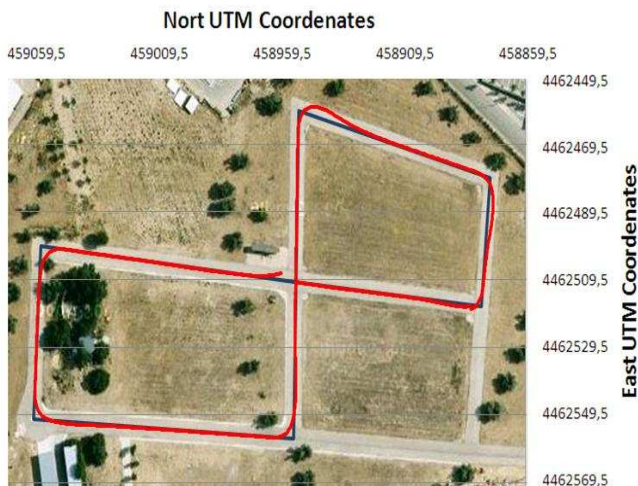

Figure 5. Route with the phase 2 architecture.

The Figure 5 shows a route followed by a van in which the new architecture, where the hardware of the low level control is separated of the guidance system, has been

boarded. In this case, the actual path almost overlaps the target path. This test shows the almost perfect tracking of 90° bends. In the central top Figure 5, the hardest bend of the circuit has 105°, the control tracks it well, but we can see it fits better the other bends.

The Figure 6 shows the steering response (in degeed). The green plot is the output of the high level control, the fuzzy, and the red one is the actually achieved position that the PID produces at the low level control. The difference between both graphics is caused by the delay of the system (1) ( $T_o=0.5$  s). We can see that the PID controller smoothes the fuzzy control output.

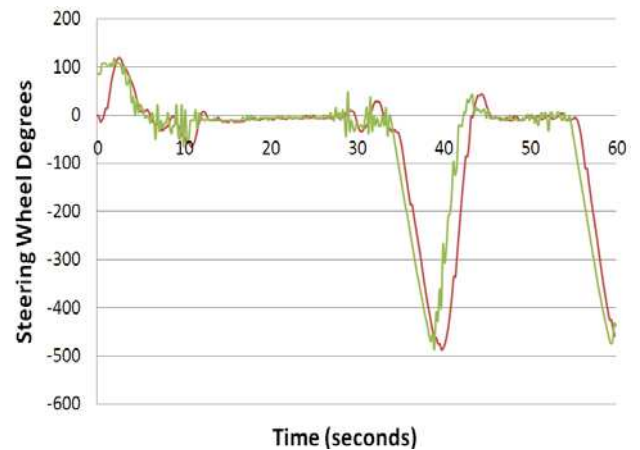

Figure 6. Steering Wheel output.

The Figure 7 represents in the red plot the data acquired by Platero when it is manually driven and the control system works in monitor mode. As the new architecture was first implemented for autonomous cars, this experiment shows that the new instrumentation can be installed fast and easy and is modular and portable.

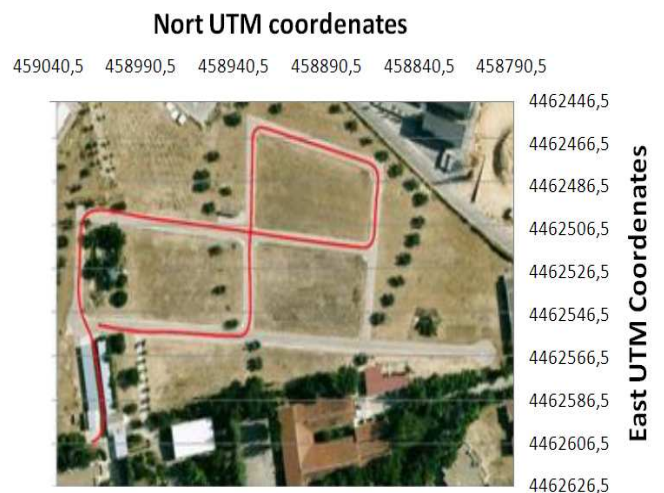

Figure 7. Monitor route in ZOCO.

Finally the Figure 8 shows the execution times of the main control loop, in each one of its stages: perception, decision and action. We can see a considerable improvement, because the old system executed the control in 24ms, and the new one does the same in half time, 12 ms.

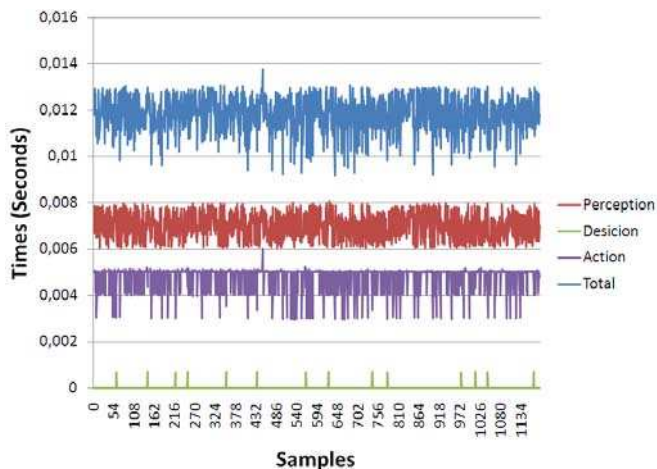

Figure 8. Control loop Time.

#### IV-CONCLUSIONS

In this paper, a new architecture for the control of the autonomous vehicles is presented. It has been implemented and tested in the cars of the AUTOPIA program, two automated electric vans and a serial Citroën C3.

The evolution of the architecture has been carried out in two steps. The first one separates the low level control stage, while maintaining the existing control hardware and converting it to an Ethernet controlled peripheral. This change permits to replace the old control system by a new generation control device in a second step.

The results show how the execution times of the control loop is reduced permitting to increase the GPS data rate frequency should it be eventually necessary.

The modularity and portability of the system permits several kind of devices (vision camera, laser, inertial sensors, etc) to be added in the architecture, making that the cooperation with other research groups can be carried out with a minimum of effort

The monitor mode will permit to do cooperative maneuvers with any kind of car, independently of they being autonomous or not.

#### ACKNOWLEDGES

This work was carried out with the support of projects MARTA (2007, CENIT) and TRANSITO (TRA 2008-06602-C03-01) project from the Spanish Government [Plan Nacional] ENVITE (Spain Ministerio de Fomento T7/06).

#### REFERENCES

- [1] Shladover S.E. [Automated vehicles for highway operations (automated highway systems)] *Systems and Control Engineering*, pp 53-75, 2005.
- [2] Joshi R. et al [Vector control: A New Control Technique for Latest Automotive Applications (EV)] *First International Conference on Emerging Trends in Engineering and Technology, IEEE*, 2008.
- [3] Hori Y. [Future Vehicle driven by electricity and control] *University of Tokio*.
- [4] Rong-hui Z. [Study on Navigation Control Method for CyberCar Based on Machine Vision] *International Conference on Robotics and Biomimetics*, Sanya, China, December 15 -18, 2007.
- [5] Shimakage M. et Al [Desig of lane-keeping control with steering torque Input for a lane-keeping support system] *SAE Paper* 2001-01-0480, 2001.
- [6] Alcalde S. [Vehicle Instrumentation for Automatic Driving] *Degree Project. Computer Science School. Technical University of Madrid (UPM)*. January, 1999.
- [7] Milanés V. [Autonomos Vehicle based in cooperative GPS and Inertial System] *Robotica*, 2008.
- [8] Sotélo M. A. et al [Vehícle Fuzzy Driving Based On DGPS and Vision] *IEEE*, 2001.
- [9] Proyecto Cybercars, 2008 [Real-Time Data Structures and Procedures] (UE STREP FP6-02802).
- [10] Proyecto MARTA: Movilidad y Automoción con Redes de Transporte Avanzadas.
- [11] Naranjo J.E. [ACC+Stop&Go Maneuvers With Throttle and Brake Fuzzy Control] *IEEE Transactions On Intelligent Transportation Systems*, VOL. 7, NO. 2, june,2006.
- [12] Alonso J. et Al. (2007) [Cooperative Maneuvers Study Between Autonomos Cars: Overtaking] *Computer Aided Systems Theory* [EUROCAST, Canarias, Spain.
- [13] Naranjo J.E. et Al [Crossroad Cooperative Driving Base don GPS and Wireless Communication] *EUROCAST*, 2007.
- [14] Pérez J. et Al [Comunicación entre vehículos autónomos en Tiempo Real, para maniobras de alto riesgo.] *XXIX Jornadas de Automática, Tarragona*, september 2008.
- [15] Naranjo J.E. et Al [Power-Steering Control Architecture for Automatic Driving] *IEEE Transaction on intelligent Transportation Systems*, Vol 6, No 4, December 2005.
- [16] R. Garcia, T. De Pedro. "First Application of the ORBEX Coprocessor: Control of Unmanned Vehicles". *EUSFLAT-ESTYLF Joint Conference. Mathware and Soft Computing*, n. 7, vol12-3, 2000, pp. 265-273, 1999.

