



HAL
open science

A historical survey of geometric computer vision

Peter Sturm

► **To cite this version:**

Peter Sturm. A historical survey of geometric computer vision. IEEE Workshop on Omnidirectional Vision, Camera Networks and Non-Classical Cameras, Nov 2011, Barcelona, Spain. hal-00646071

HAL Id: hal-00646071

<https://inria.hal.science/hal-00646071>

Submitted on 29 Nov 2011

HAL is a multi-disciplinary open access archive for the deposit and dissemination of scientific research documents, whether they are published or not. The documents may come from teaching and research institutions in France or abroad, or from public or private research centers.

L'archive ouverte pluridisciplinaire **HAL**, est destinée au dépôt et à la diffusion de documents scientifiques de niveau recherche, publiés ou non, émanant des établissements d'enseignement et de recherche français ou étrangers, des laboratoires publics ou privés.

A historical survey of geometric computer vision

Peter Sturm, INRIA



Introduction

Three examples of today's state of the art in multi-view 3D modeling:

- **Highly detailed and accurate** shape estimation, Furukawa and Ponce
- **Real-time** shape and motion estimation, e.g. Davison et al.
- Shape estimation and geo-localization from **very many images**, Snavely et al.



Photo Tourism

Exploring photo collections in 3D

Microsoft



(a)

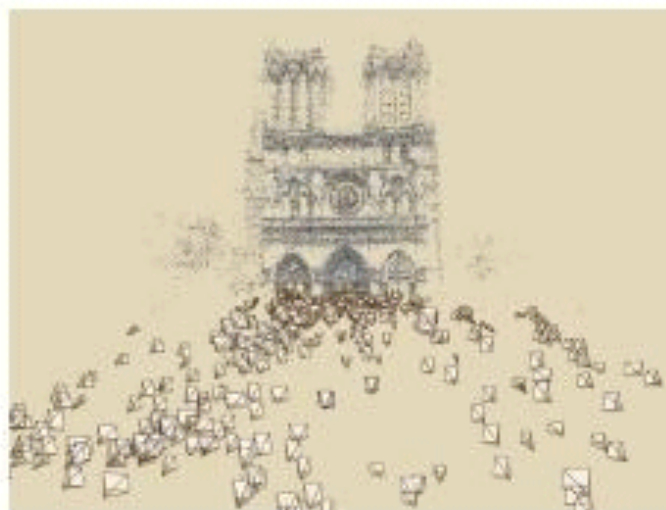

(b)



(c)

Very Brief (and Partial) History of Geometric Computer Vision

Geometrical works (“structure-from-motion”):

- 1980’s: Emergence as independent discipline, from AI and robotics
- 1982: Epipolar geometry [Longuet-Higgins]
- 1992: 3D reconstruction from uncalibrated images (projective reconstruction)
[Faugeras, Hartley]
- 1992: Self-calibration [Faugeras and Maybank]
- 1990’s: Trifocal geometry of points and lines [Aloimonos, Hartley, Shashua, Faugeras, Triggs]
- since the 1990’s: Many advances in structure-from-motion, including non-rigid objects

Other crucial works:

- since ca. 1995: systematic use of robust statistics
- since ca. 1995: use of better numerical algorithms
- since ca. 1998: true multi-view 3D surface modeling
- since ca. 2000: wide-baseline matching
- Strategies to tackle scale and/or speed requirements:
 - memory management
 - parallelization
 - hierarchical usage of images
 - etc.

Outline

- Introduction
- **1st Flashback: Invention of Photography and Photogrammetry**
- **2nd Flashback: Surveying / Topography**
- 3rd Flashback: General Orientation Procedures for Perspectives
- 4th Flashback: Discovery and Study of Perspective
- Other early examples of scientific applications of photography

1st Flashback: Invention of Photography and Photogrammetry

- 1839: After decades of research, usable photography was achieved [Daguerre and Niepcé]
- The use of photographs for measuring objects and landscapes was proposed immediately
- 1850's: Laussedat first used perspective drawings, then photographs, for measurements
 - His approach was inspired directly from surveying / topography



Aimé Laussedat (1819-1907)

2nd Flashback: Surveying / Topography

- Surveying procedures are in use since at least ca. 5000 years (Egypt: 3000 BC)
- Laussedat's inspiration:
 - From ca. 1793: Beautemps-Beaupré created maps of coastlines during expeditions, from angular and distance measurements reported on drawings

2nd Flashback: Surveying / Topography

- Laussedat's inspiration:
 - From ca. 1793: Beautemps-Beaupré created maps of coastlines during expeditions, from angular and distance measurements reported on drawings (contrary to later interpretations, the drawings only seemed to serve as support to report measurements, not to make measurements from them)

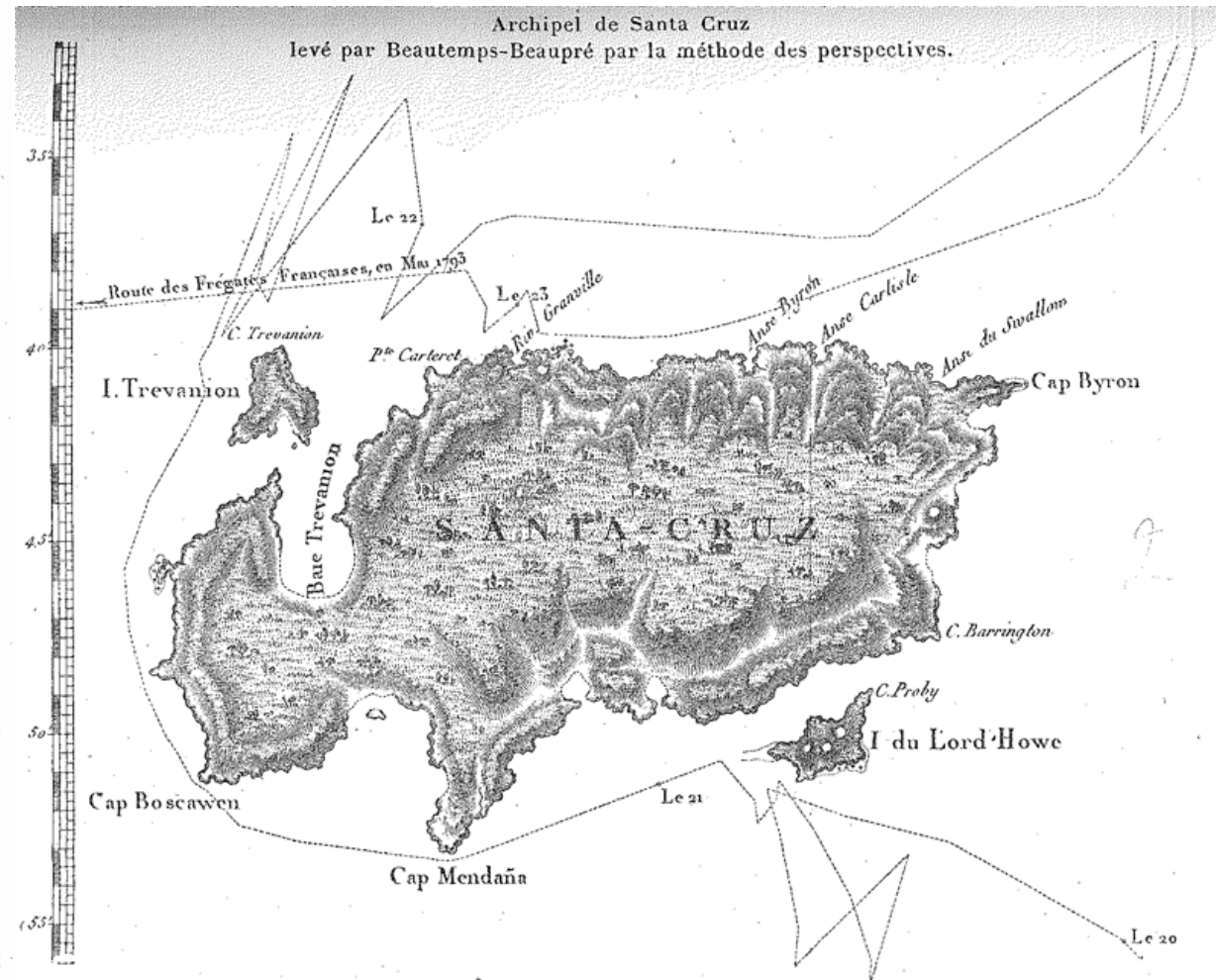
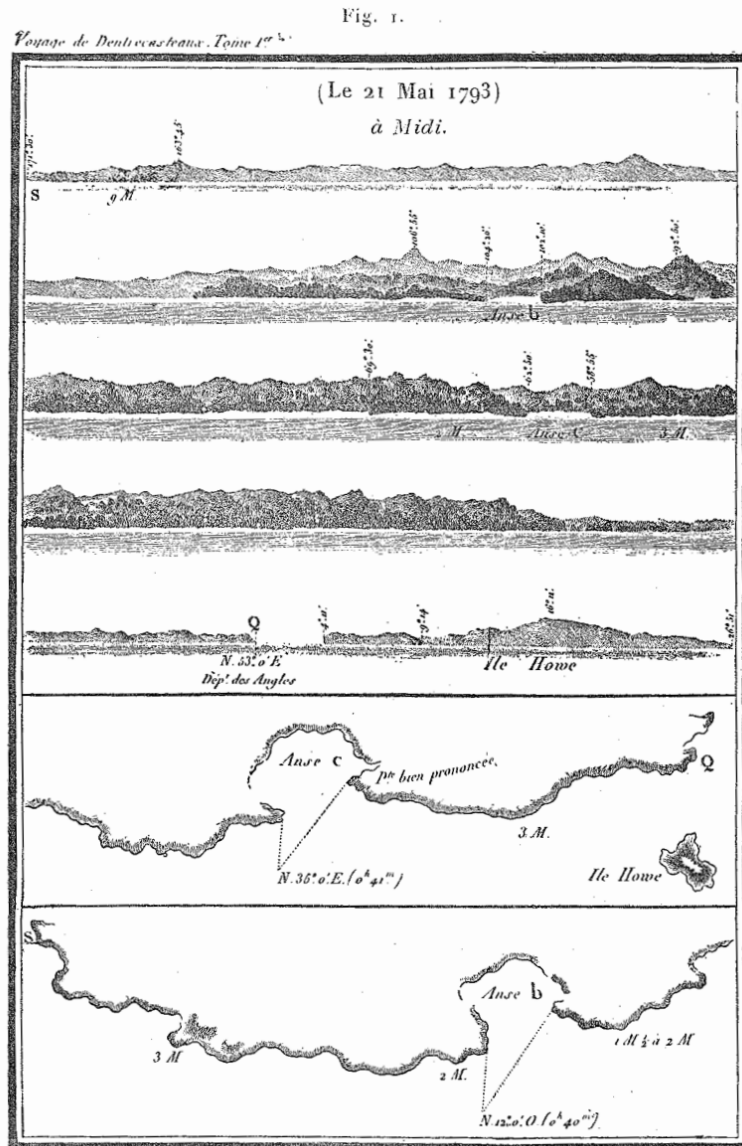

1st Flashback: Invention of Photography and Photogrammetry

- Laussedat's approach, demonstrated for a camera lucida (used in 1854):

Camera lucida: Wollaston, 1807
(Kepler, 1611)



Perspective drawing made by Laussedat

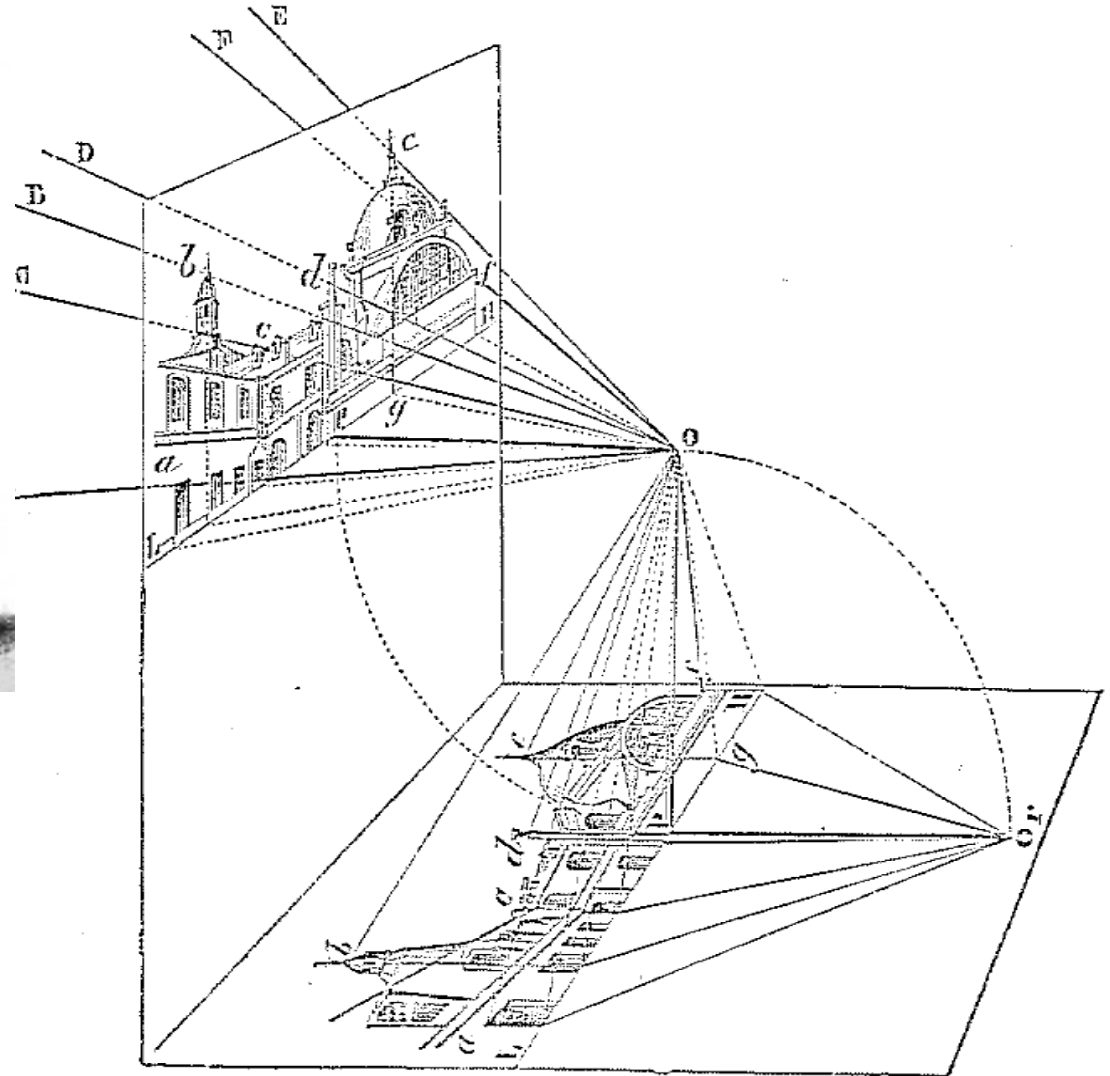

1st Flashback: Invention of Photography and Photogrammetry

- Laussedat's approach, demonstrated for a camera lucida (used in 1854):

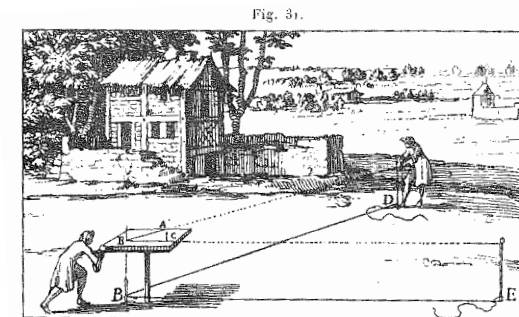
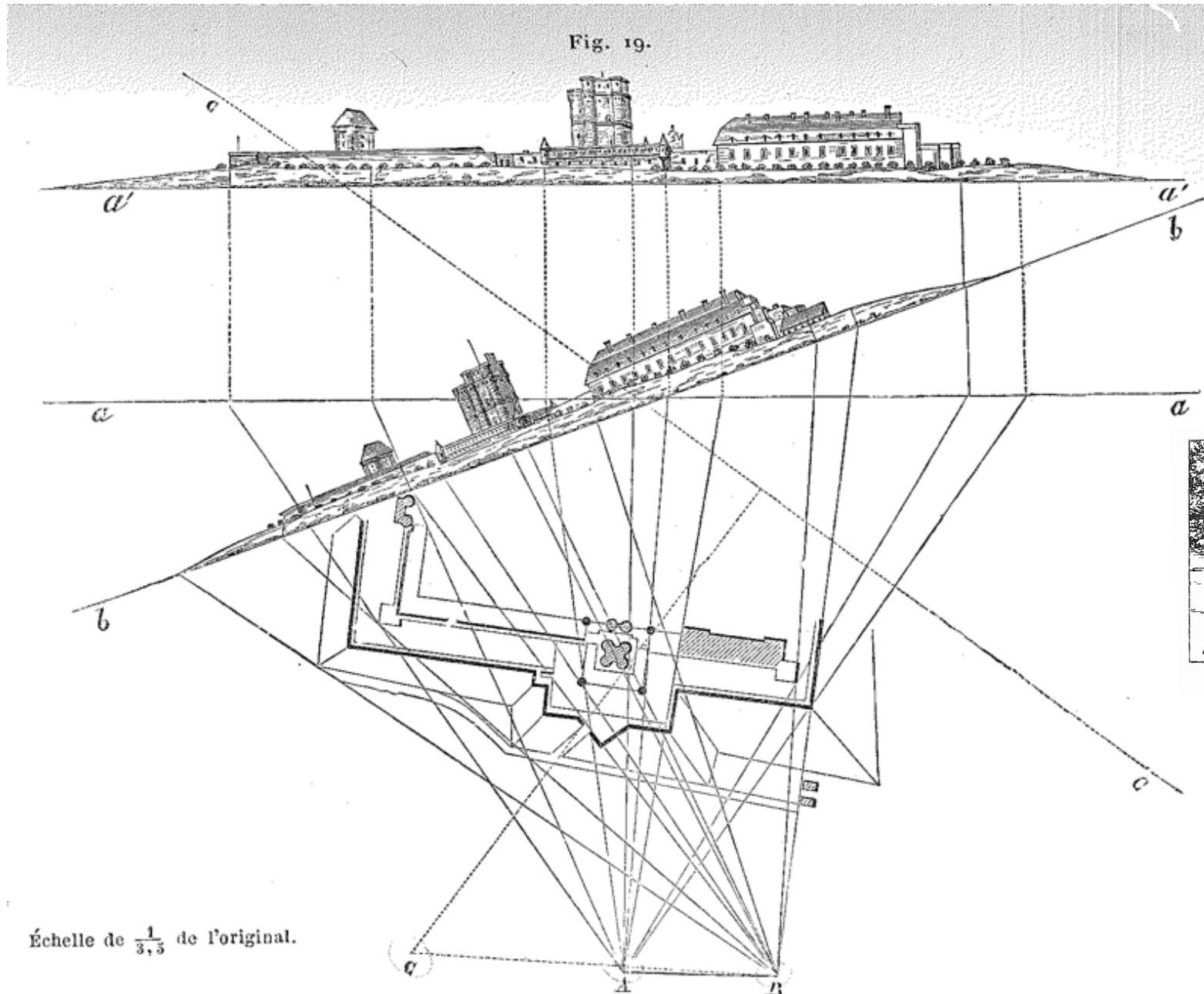

Emploi de la planchette simple sur le terrain.



1st Flashback: Invention of Photography and Photogrammetry

- 1850's: Photogrammetry was born
- 1726: Kappeler created a topographic map of a Swiss mountain range, apparently with the aide of perspective drawings. However, no clear description of his approach is known and he is thus not commonly considered as inventor of “photo”grammetry.

Some next steps over the decades:

- Improved equipment, for example:
 - Portable equipment



PORTABLE PHOTOGRAPHIC APPARATUS.

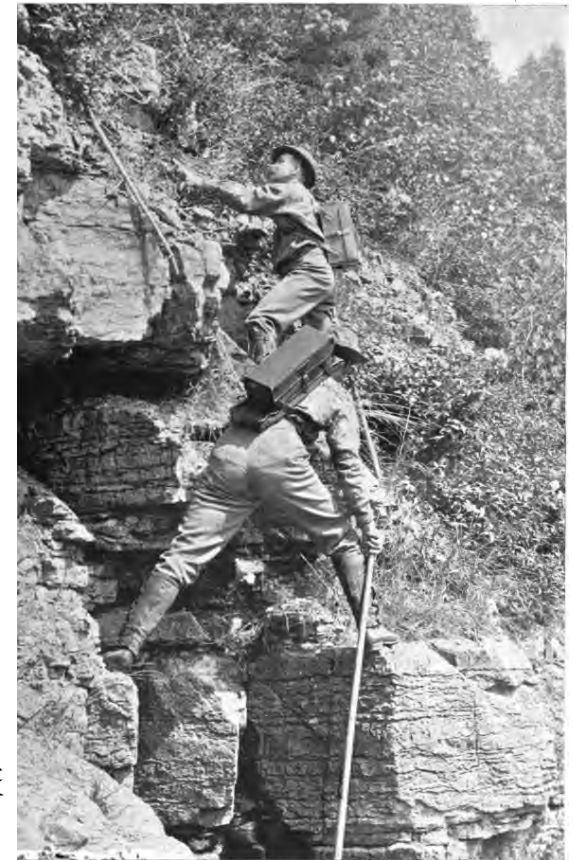

TOPOGRAPHER and ASSISTANT,
Showing mode of carrying instruments.

1st Flashback: Invention of Photography and Photogrammetry

- 1850's: Photogrammetry was born
- 1726: Kappeler created a topographic map of a Swiss mountain range, apparently with the aide of perspective drawings. However, no clear description of his approach is known and he is thus not commonly considered as inventor of “photo”grammetry.

Some next steps over the decades:

- Improved equipment, for example:
 - Portable equipment
 - Phototheodolite

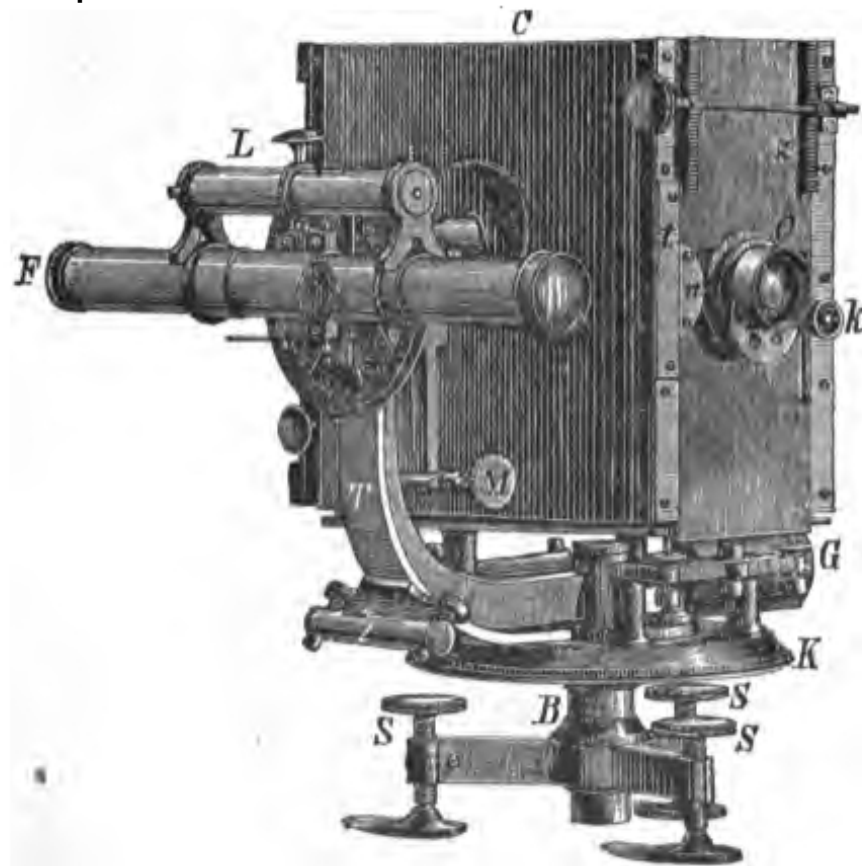

1st Flashback: Invention of Photography and Photogrammetry

- 1850's: Photogrammetry was born
- 1726: Kappeler created a topographic map of a Swiss mountain range, apparently with the aide of perspective drawings. However, no clear description of his approach is known and he is thus not commonly considered as inventor of “photo”grammetry.

Some next steps over the decades:

- Improved equipment, for example:
 - Portable equipment
 - Phototheodolite
 - Panoramic photography (from 1843!)



Cylindrograph, Moëssard 1884

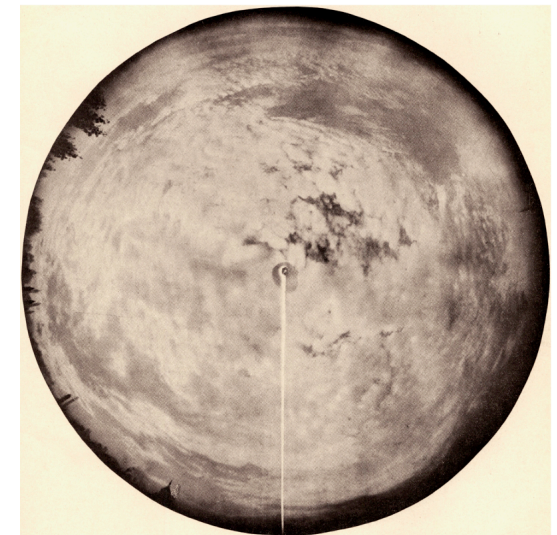
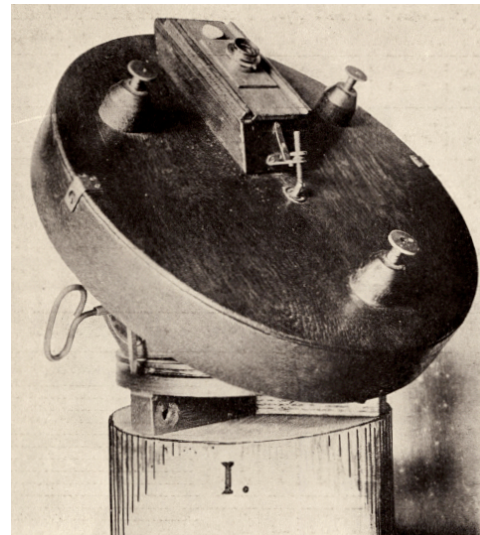

“Cloud camera”, 190?

1st Flashback: Invention of Photography and Photogrammetry

- 1850's: Photogrammetry was born
- 1726: Kappeler created a topographic map of a Swiss mountain range, apparently with the aide of perspective drawings. However, no clear description of his approach is known and he is thus not commonly considered as inventor of “photo”grammetry.

Some next steps over the decades:

- Improved equipment, for example:
 - Portable equipment
 - Phototheodolite
 - Panoramic photography (from 1843!)
 - Multi-camera systems (from 1870's or 1880's)

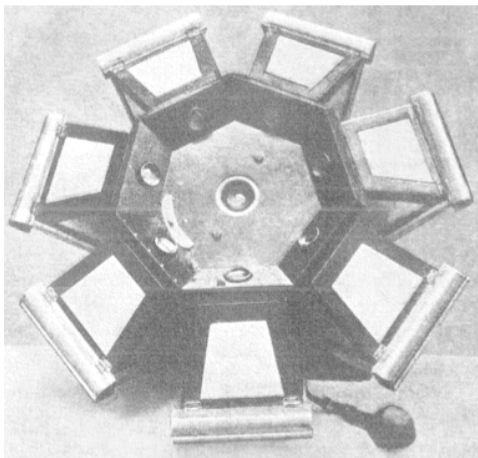

Scheimpflug, 190?

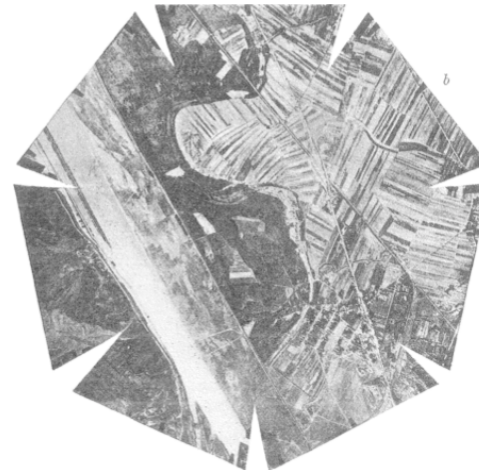
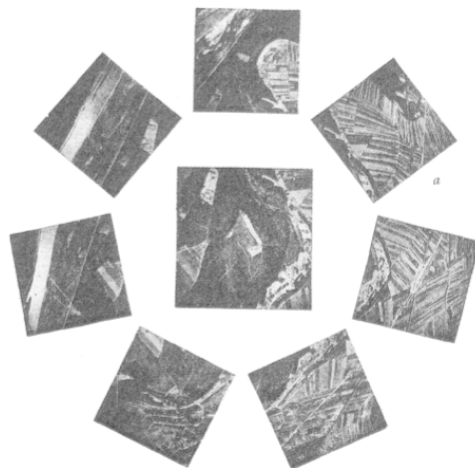

1st Flashback: Invention of Photography and Photogrammetry

- 1850's: Photogrammetry was born
- 1726: Kappeler created a topographic map of a Swiss mountain range, apparently with the aide of perspective drawings. However, no clear description of his approach is known and he is thus not commonly considered as inventor of “photo”grammetry.

Some next steps over the decades:

- Improved equipment, for example:
 - Portable equipment
 - Phototheodolite
 - Panoramic photography (from 1843!)
 - Multi-camera systems (from 1870's or 1880's)
- Orientation procedures for more general image acquisition procedures, e.g. for aerial imaging

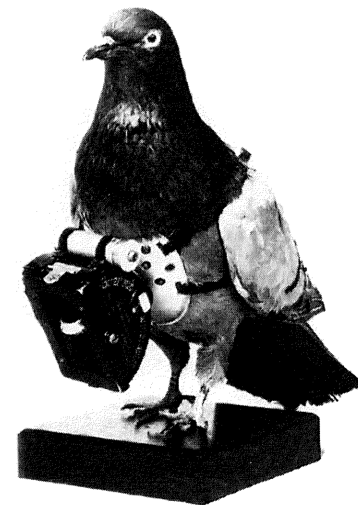

Outline

- Introduction
- 1st Flashback: Invention of Photography and Photogrammetry
- 2nd Flashback: Surveying / Topography
- **3rd Flashback: General Orientation Procedures for Perspectives**
- **4th Flashback: Discovery and Study of Perspective**
- Other early examples of scientific applications of photography

3rd Flashback: General Orientation Procedures for Perspectives

Goal: enable to work with images acquired in general position

Four basic procedures are:

- **Calibration** (inner orientation)
- Triangulation of 3D points (intersection)
- Pose estimation (resection): estimate position and orientation from image of known object
- Motion estimation (relative orientation): relative position/orientation of two images

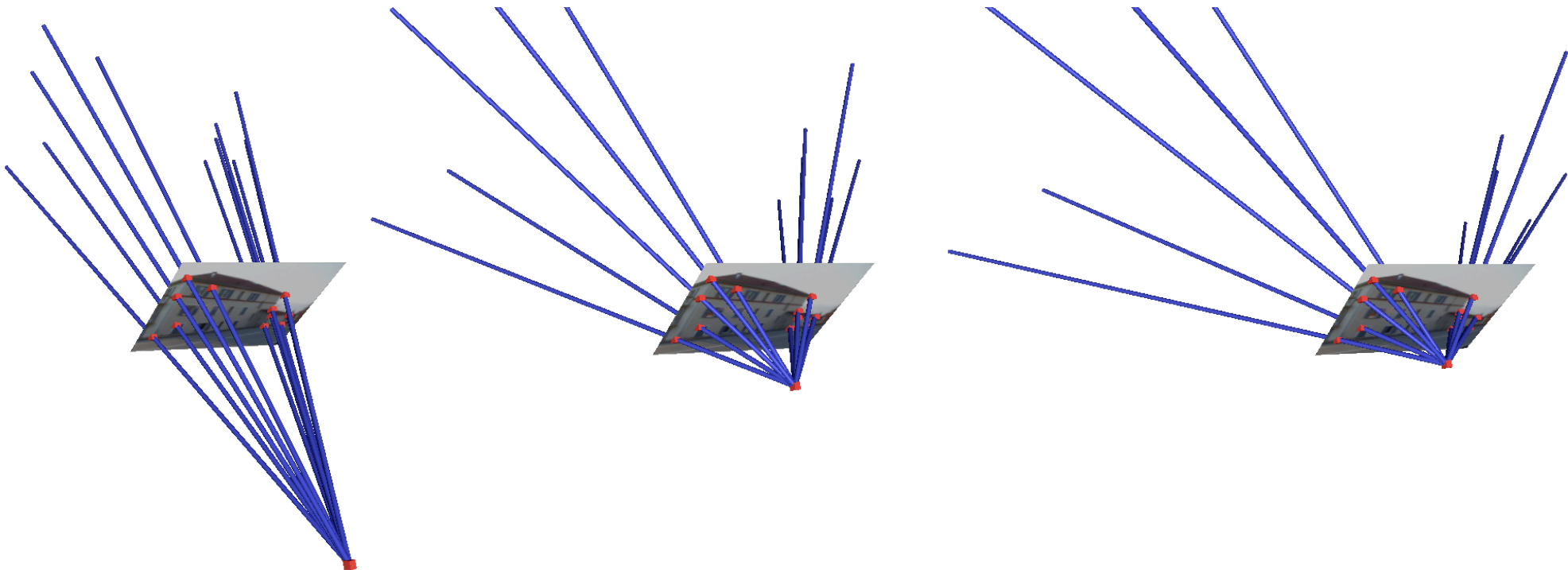

3rd Flashback: General Orientation Procedures for Perspectives

Goal: enable to work with images acquired in general position

Four basic procedures are:

- Calibration (inner orientation)
- **Triangulation** of 3D points (intersection)

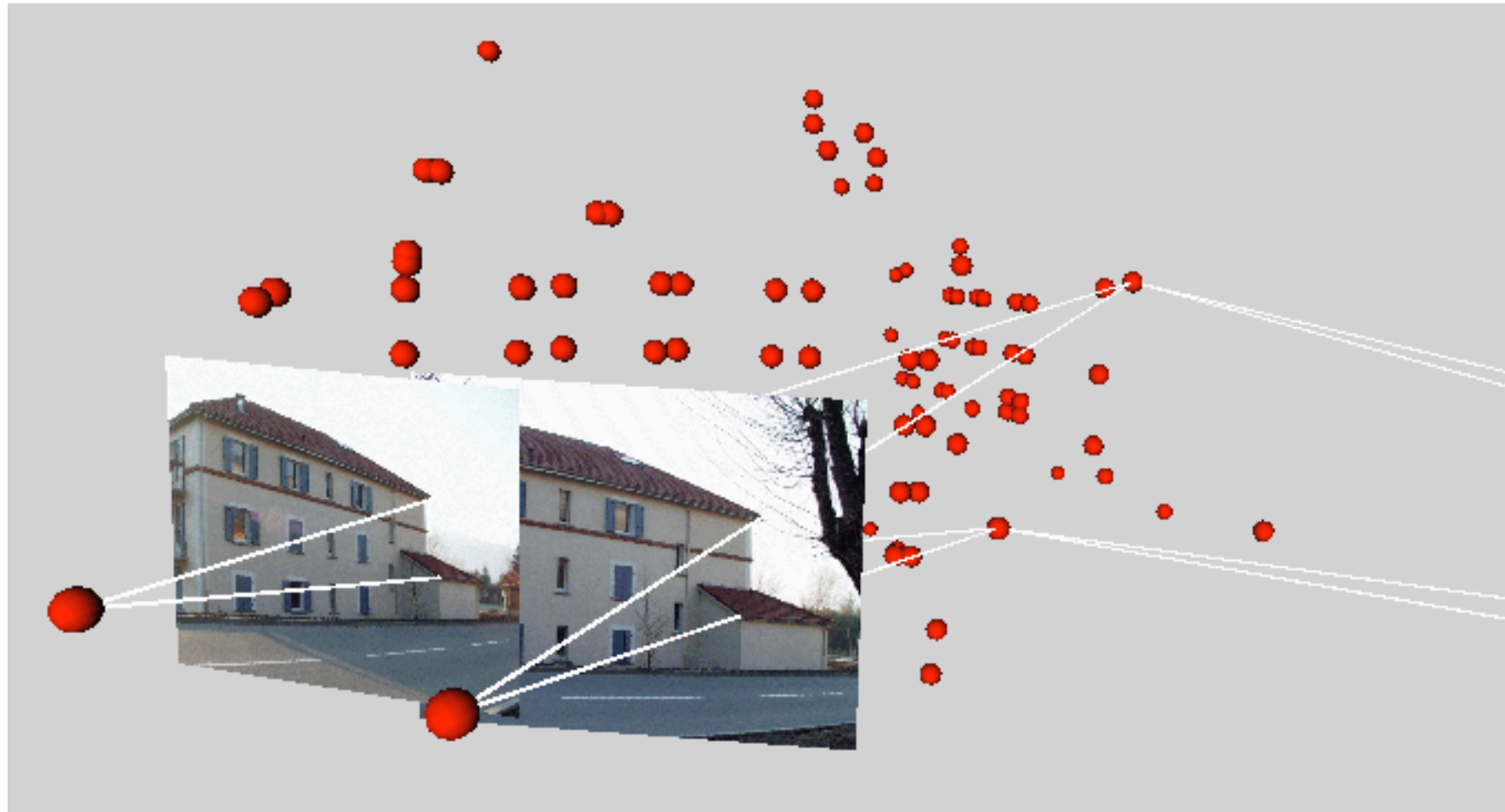

n object

3rd Flashback: General Orientation Procedures for Perspectives

Goal: enable to work with images acquired in general position

Four basic procedures are:

- Calibration (inner orientation)
- Triangulation of 3D points (intersection)
- **Pose** estimation (resection): estimate position and orientation from image of known object
- Motion estimation (relative orientation): relative position/orientation of two images

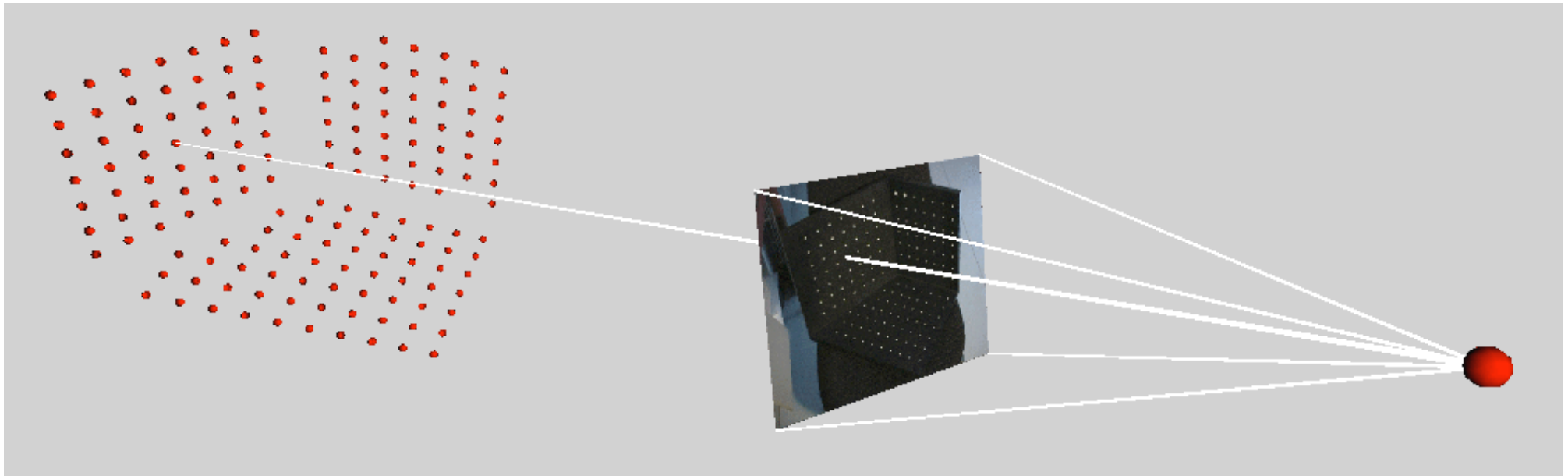

3rd Flashback: General Orientation Procedures for Perspectives

Goal: enable to work with images acquired in general position

Four basic procedures are:

- Calibration (inner orientation)
- Triangulation of 3D points (intersection)
- Pose estimation (resection): estimate position and orientation from image of known object
- **Motion** estimation (relative orientation): relative position/orientation of two images

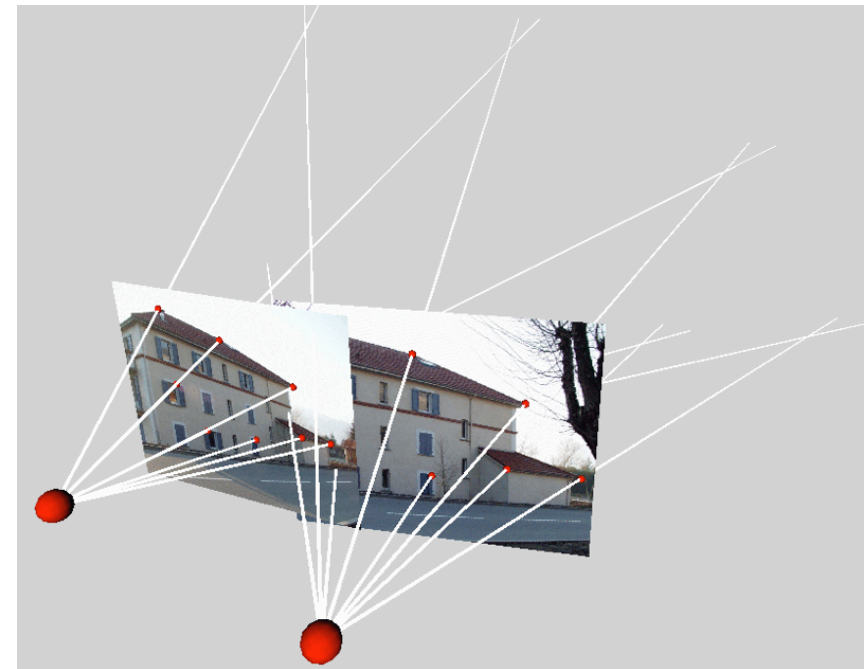
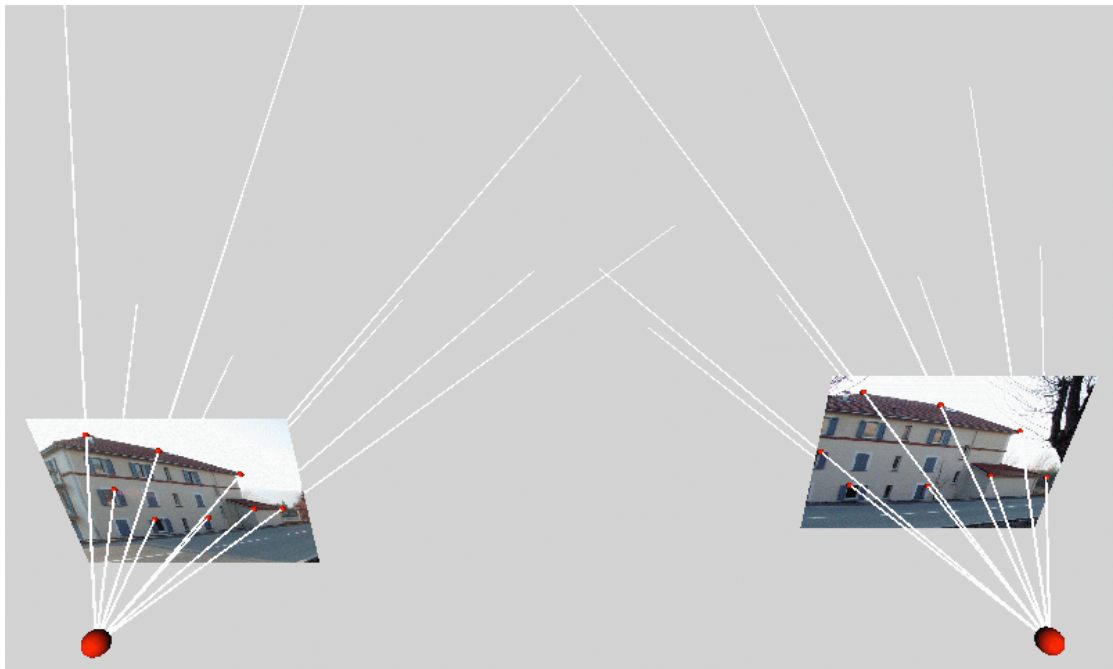

3rd Flashback: General Orientation Procedures for Perspectives

Goal: enable to work with images acquired in general position

Four basic procedures are:

- Calibration (inner orientation)
- Triangulation of 3D points (intersection)
- Pose estimation (resection): estimate position and orientation from image of known object
- **Motion** estimation (relative orientation): relative position/orientation of two images

These were achieved in full generality by exploiting the principles of perspective projection and sometimes, using projective geometry.

4th Flashback: Discovery and Study of Perspective

Camera obscura and pinhole camera: principles (partly) known since over 2400 years [wikipedia]:

- China: 5th century BC
- Greece: 4th century BC
- Egypt: 11th century
- Throughout Europe: from 11th century onwards

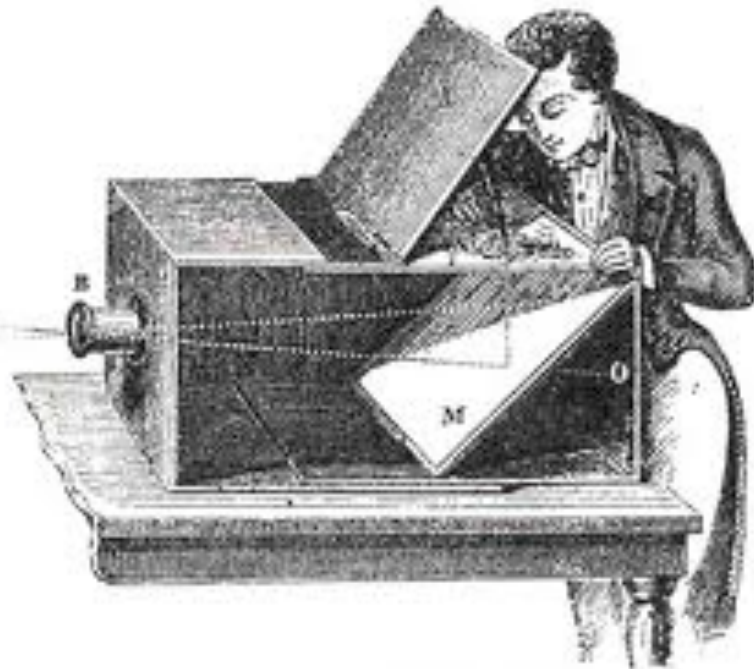
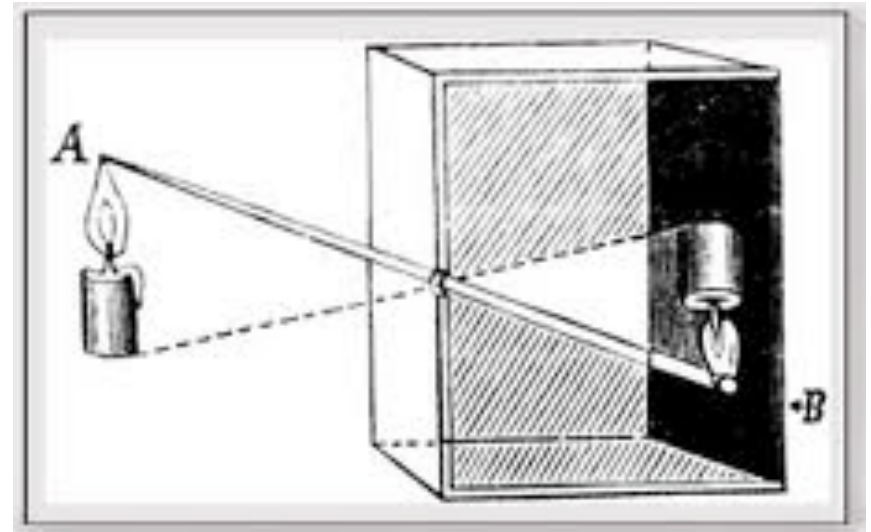

4th Flashback: Discovery and Study of Perspective

Full discovery and mathematical treatment seems to have started with the **Italian renaissance** in the 15th century and lasted till the 19th century

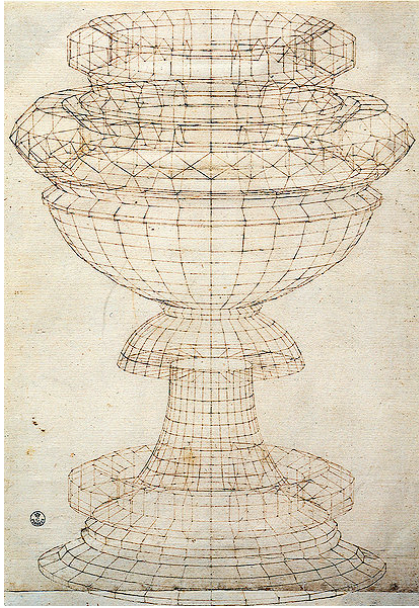

Perspective study of a chalice,
Uccello, ca. 1450

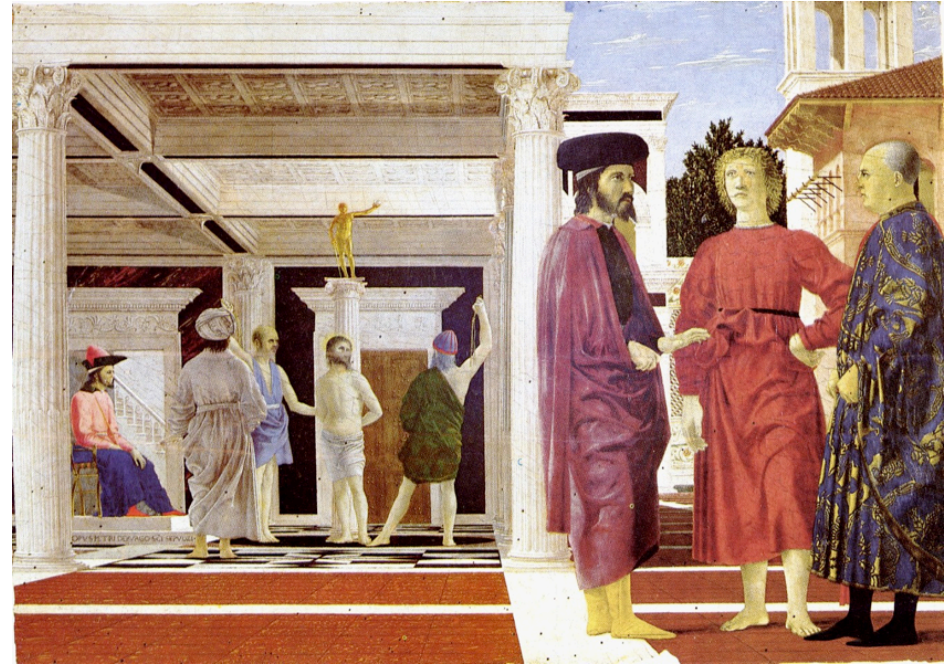

The flagellation of Christ, della Francesca, ca. 1460

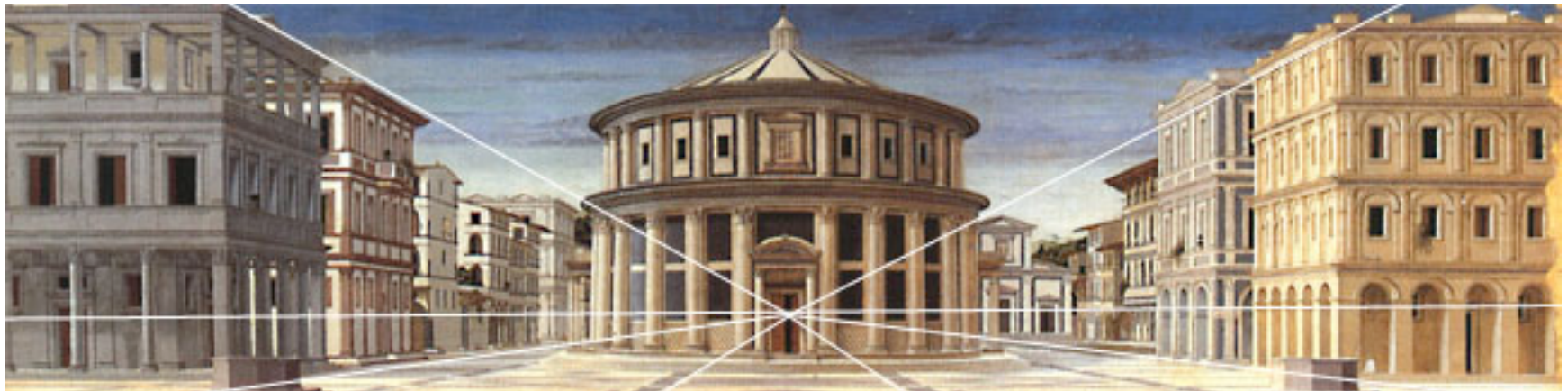

Ideal City, della Francesca, ca. 1470

4th Flashback: Discovery and Study of Perspective

Full discovery and mathematical treatment seems to have started with the Italian renaissance in the 15th century and lasted till the 19th century

This included the development of processes for generation of perspective drawings, e.g.:

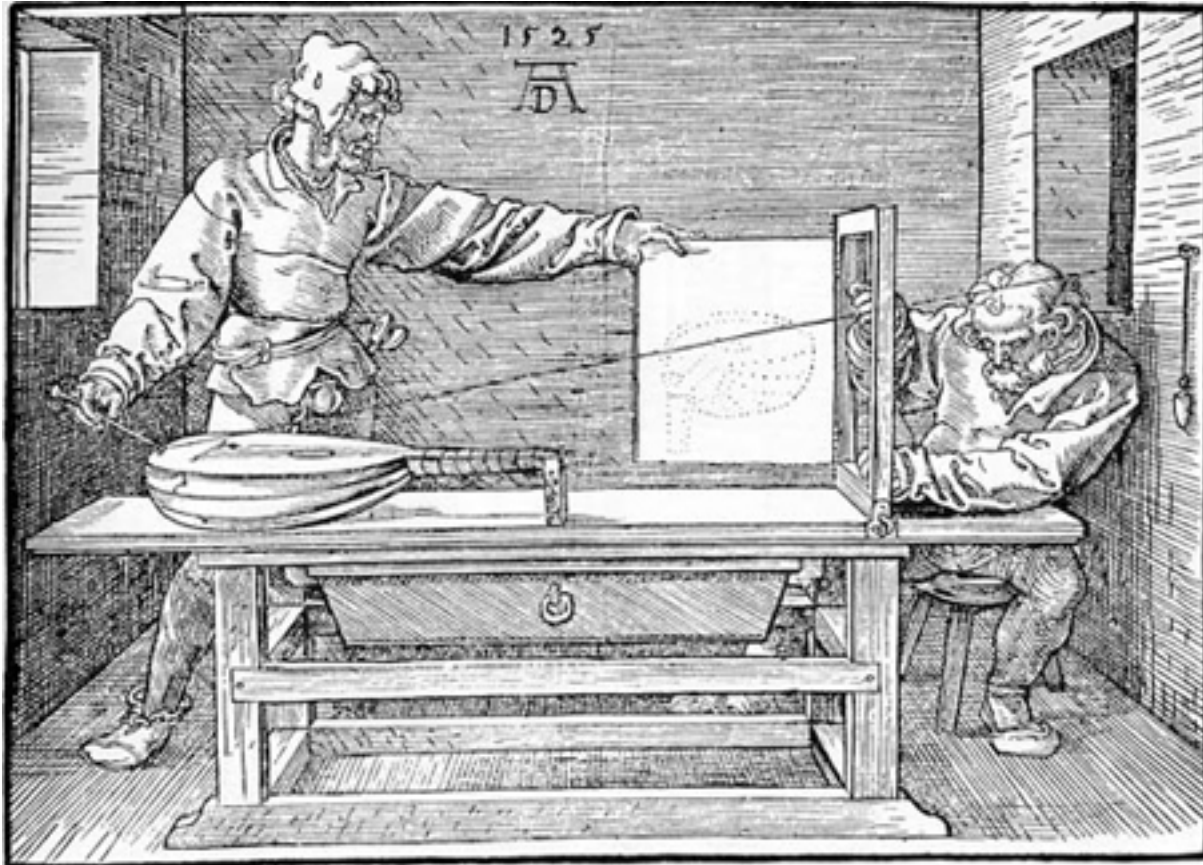

Dürer, 1525

4th Flashback: Discovery and Study of Perspective

Full discovery and mathematical treatment seems to have started with the Italian renaissance in the 15th century and lasted till the 19th century

First complete theories and recipes of perspective principles:

- Taylor, 1715

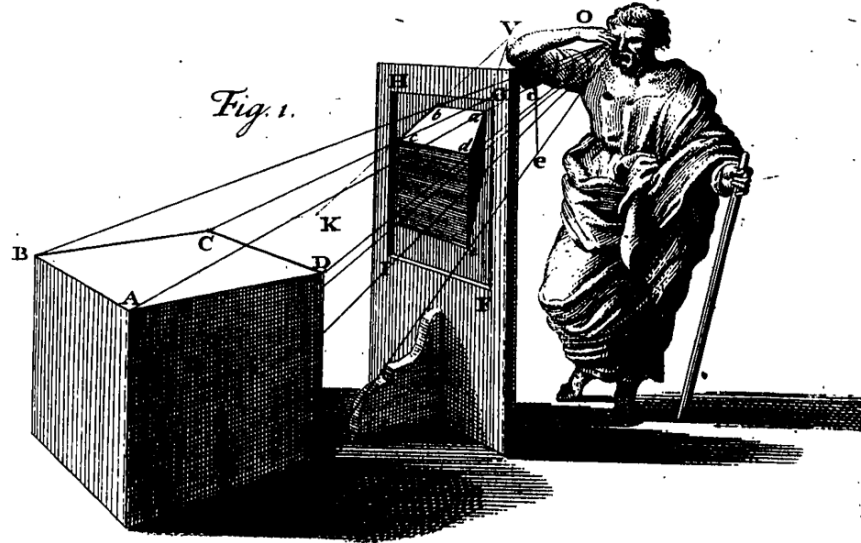

Brook Taylor (1685-1731)

- Lambert, 1759

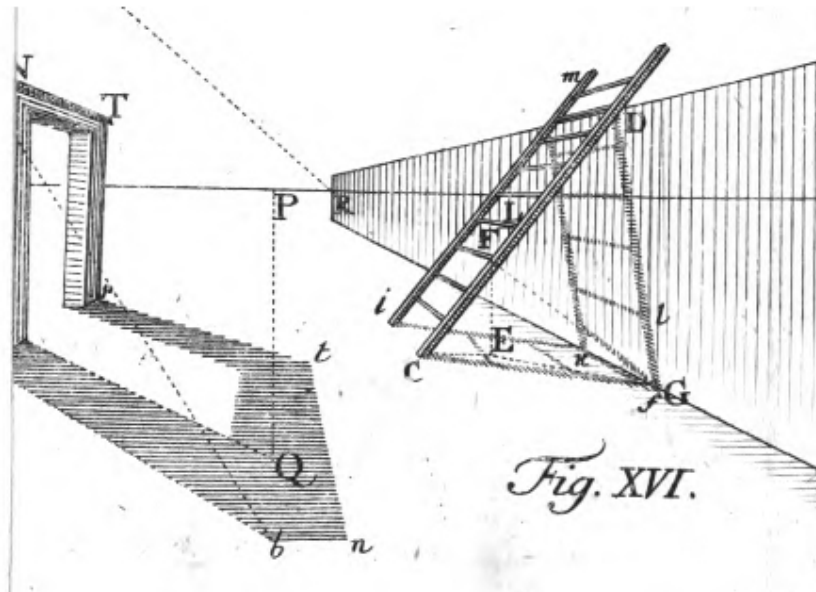

Johann Heinrich Lambert (1728-1777)

4th Flashback: Discovery and Study of Perspective

Full discovery and mathematical treatment seems to have started with the Italian renaissance in the 15th century and lasted till the 19th century

Inverse problems of perspective:

- Leonardo da Vinci seems to have been one of the first to wonder how to determine the painter's eye point from a perspective painting. He does not seem to have investigated this further though.
- Others studied two types of inverse problems (for single perspectives):
 - determine the painter's eye point (pose estimation...)
 - determine an object's shape
- In both cases, assumptions need to be made on the object (shape/position/orientation)
- The following scientists proposed solutions for various special cases:

Guidobaldo, 1600

Stevin, 1605

Marolois, 1614

Taylor, 1715

Lambert, 1759

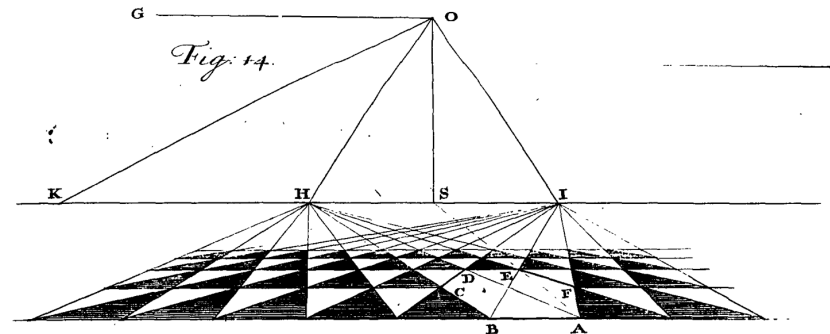

4th Flashback: Discovery and Study of Perspective

Two **pre-photography** discoveries that are still used/relevant today, expressed in “computer vision language”:

1715, Taylor: an algorithm for estimating the focal length and principal point of a camera, as well as the side lengths of a cuboid, from an image thereof

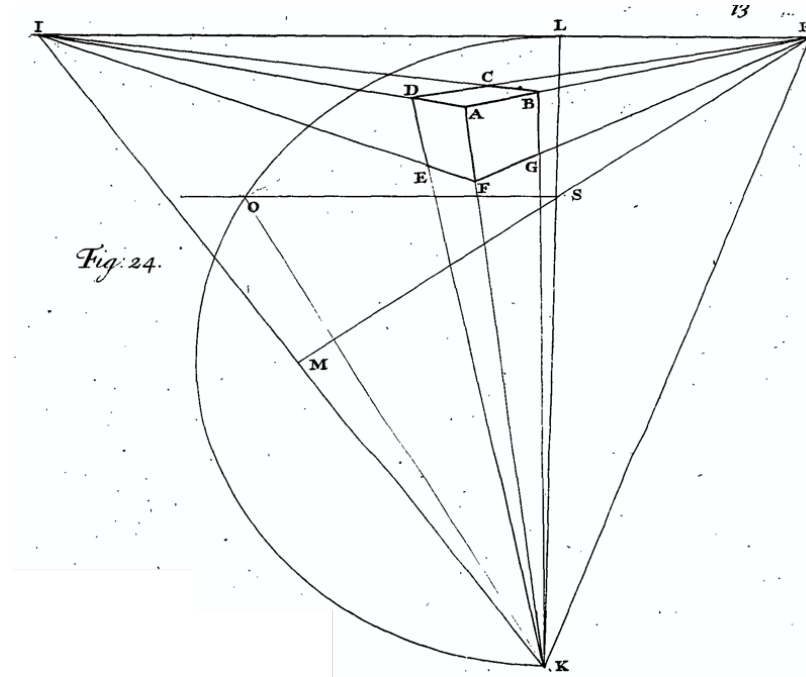

1773, Lagrange: full sketch of a solution to the general 3-point **pose** problem

- earliest other known reference: Grunert, 1841
- planar 3-point pose problem was solved ca. 1615 by Snellius

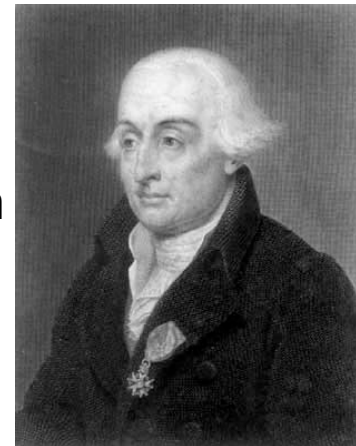

Joseph-Louis Lagrange (1736-1813)

3rd Flashback: General Orientation Procedures for Perspectives

Results after the invention of photography:

Epipolar geometry

1862, Terrero

1883, Hauck

1899, Finsterwalder: solution for 4 coplanar and 2 other points

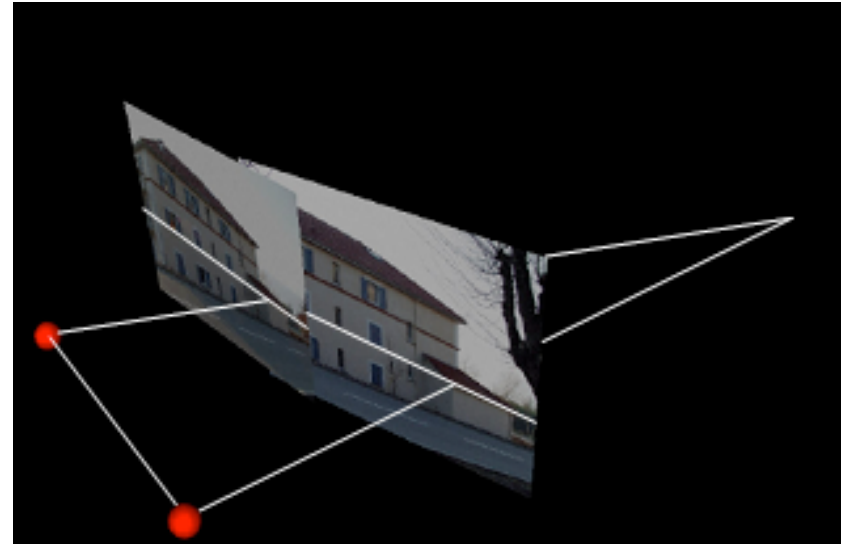

Trifocal geometry (trilinear matching constraints, for points and lines)

1883, Hauck: besides deriving the theory, Hauck also designed and built a device allowing to draw a perspective image from two orthographic ones

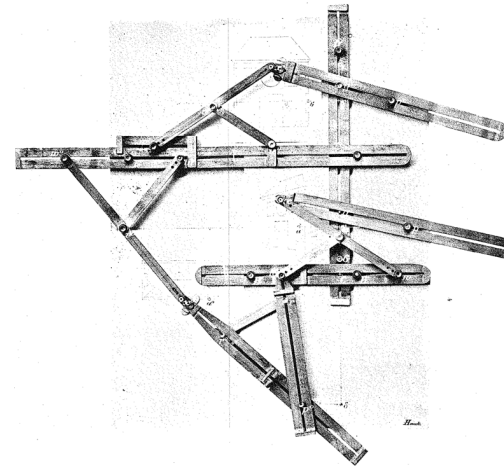
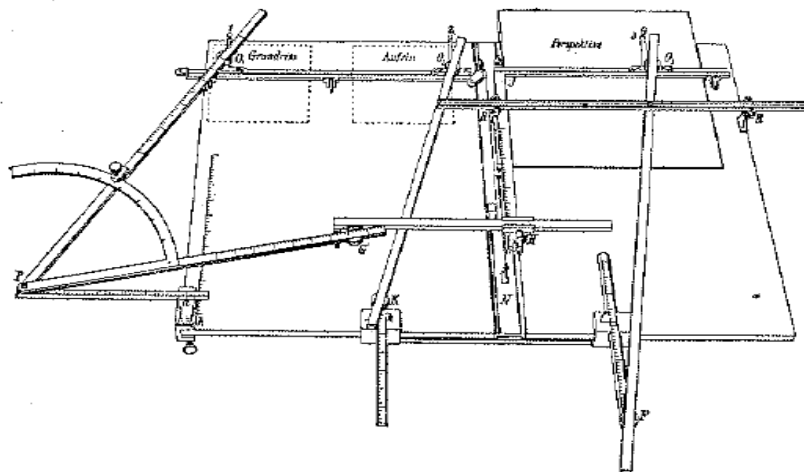

PERSPECTOGRAPHE DE GUIDO HAUCK

3rd Flashback: General Orientation Procedures for Perspectives

Results after the invention of photography:

Motion estimation

1880, Schröter: 4-point problem for coplanar object points

1913, Kruppa: 5-point problem

2003, Nistér: first algorithm for the 5-point problem that gives at most 10 solutions

3D modeling from a single image using vanishing points and lines

1883, Hauck

1892, Meydenbauer

18??, Laussedat

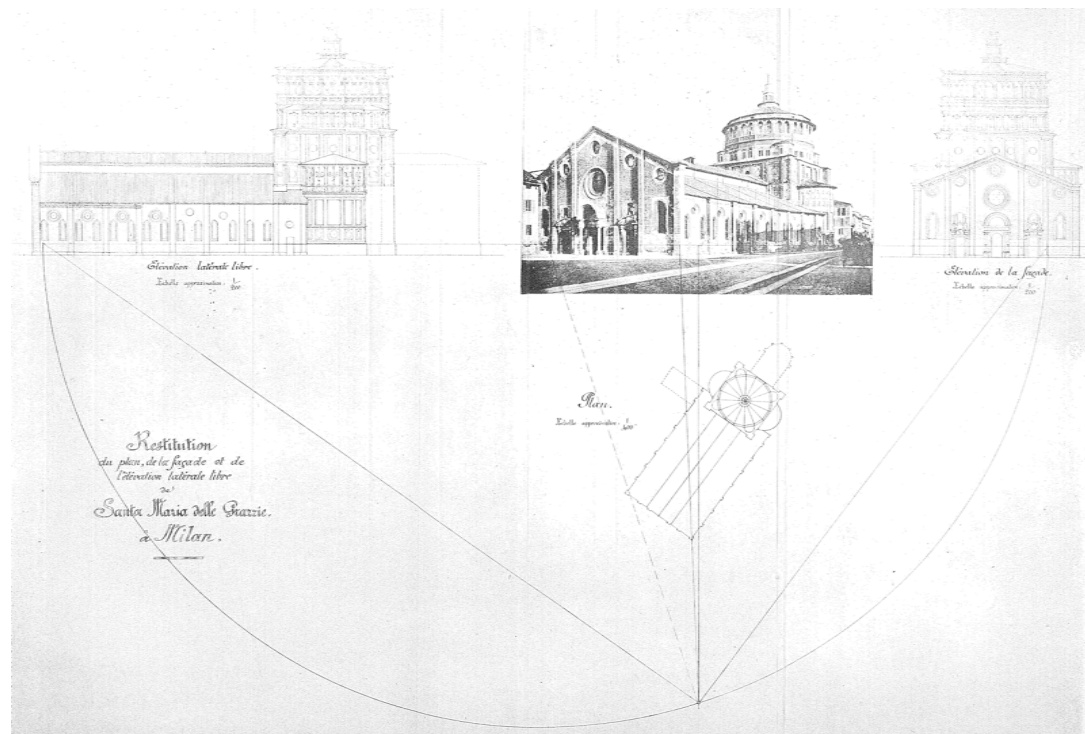

3rd Flashback: General Orientation Procedures for Perspectives

Results after the invention of photography:

3D reconstruction from uncalibrated images (projective reconstruction)

1883, Hauck

1899, Finsterwalder

Camera self-calibration

1892, Meydenbauer: mentions that self-calibration of a rotating camera is possible

1899, Finsterwalder: self-calibration approach for general motion, based on the concepts of absolute conic and circular points

3D modeling using mirror images or exploiting symmetries of objects

1899, Finsterwalder

1905, Pulfrich

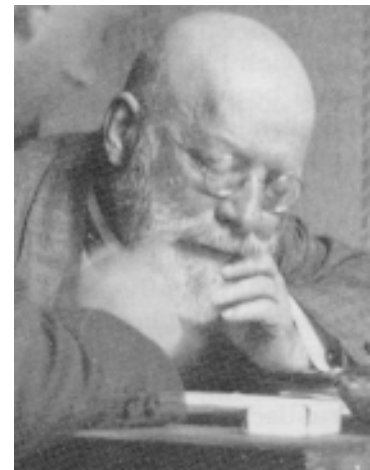
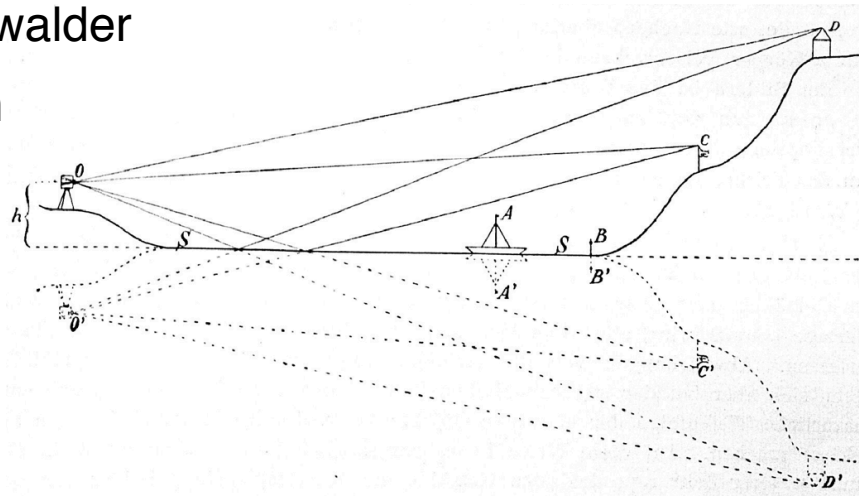

Sebastian Finsterwalder (1862-1951)

3rd Flashback: General Orientation Procedures for Perspectives

Examples of photogrammetric and photographic equipment:

Stereoautograph, around 1908

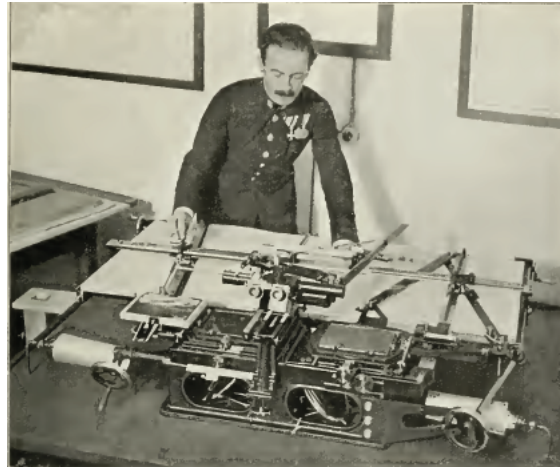

ca. 1930

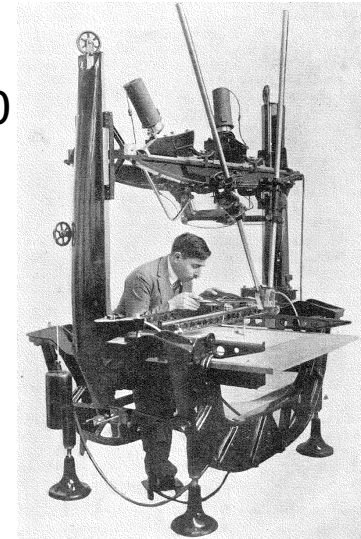

Collimator-based camera calibration

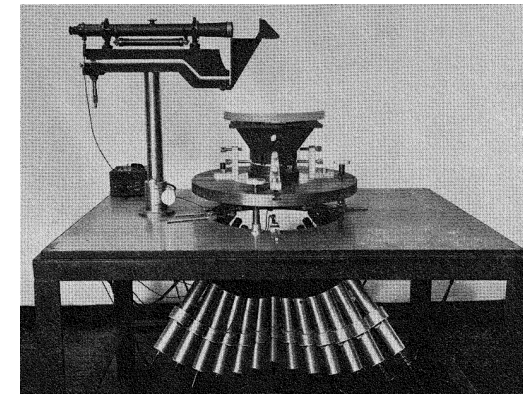
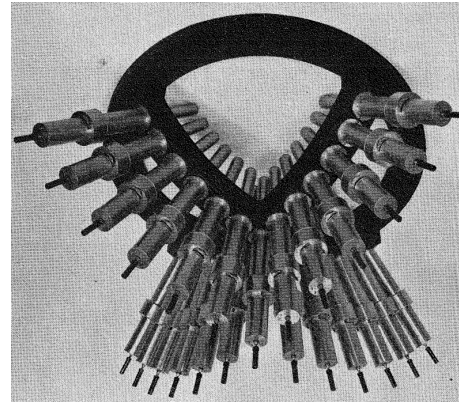

Mirror-based stereo camera and stereo viewing, 1930

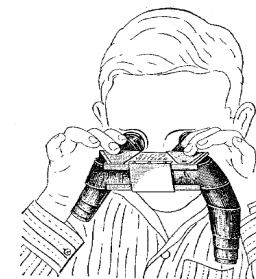
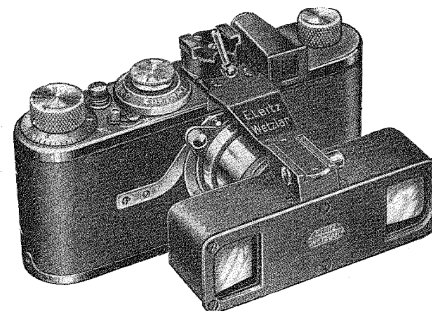

Outline

- Introduction
- 1st Flashback: Invention of Photography and Photogrammetry
- 2nd Flashback: Surveying / Topography
- 3rd Flashback: General Orientation Procedures for Perspectives
- 4th Flashback: Discovery and Study of Perspective
- **Other early examples of scientific applications of photography**

Cow Topography

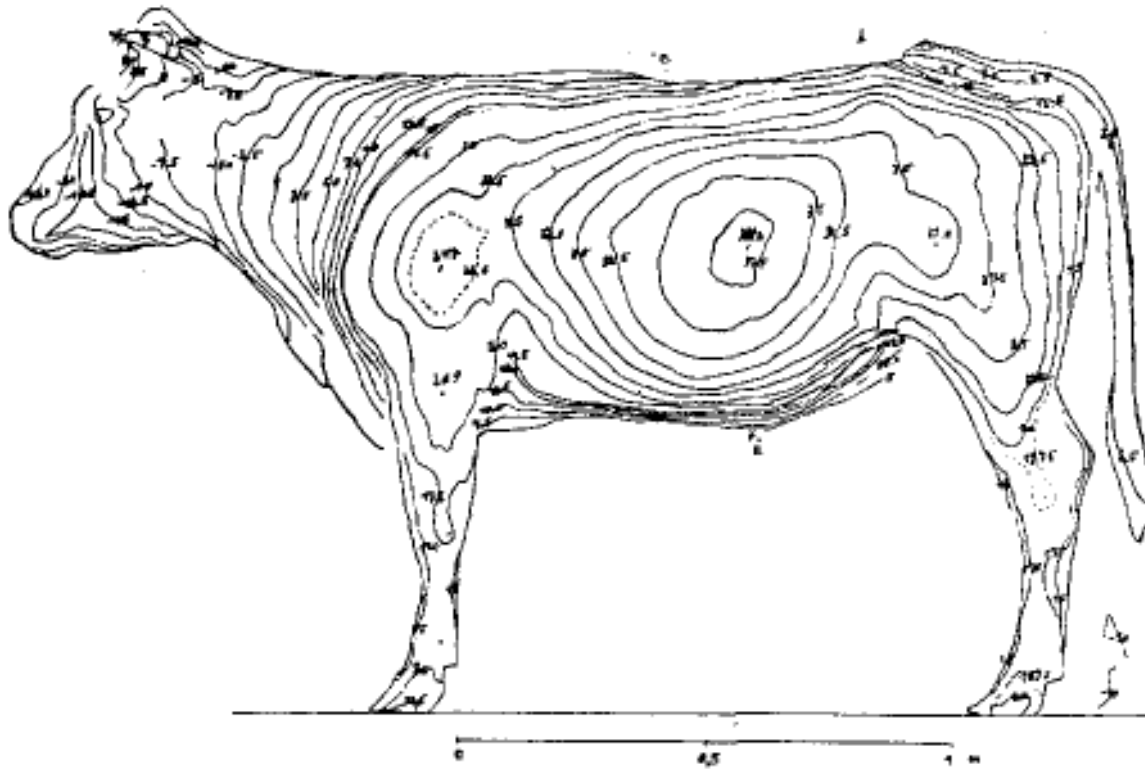
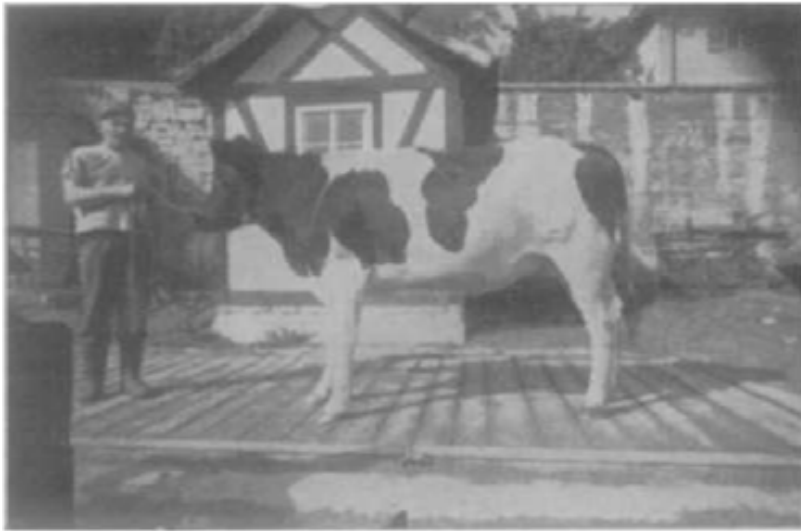

Leydolph, around 1938

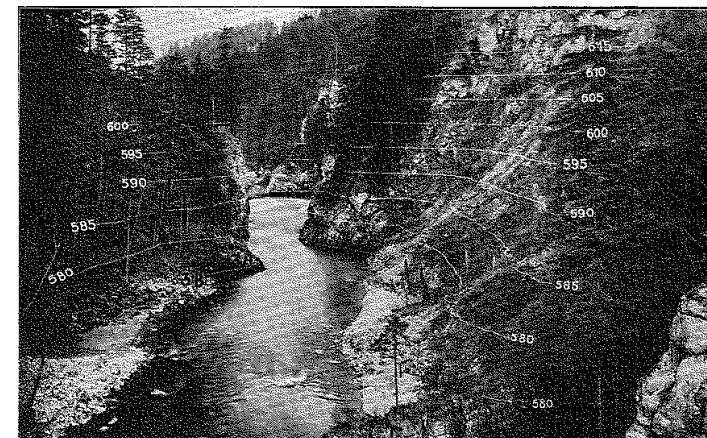

Underwater photography/photogrammetry

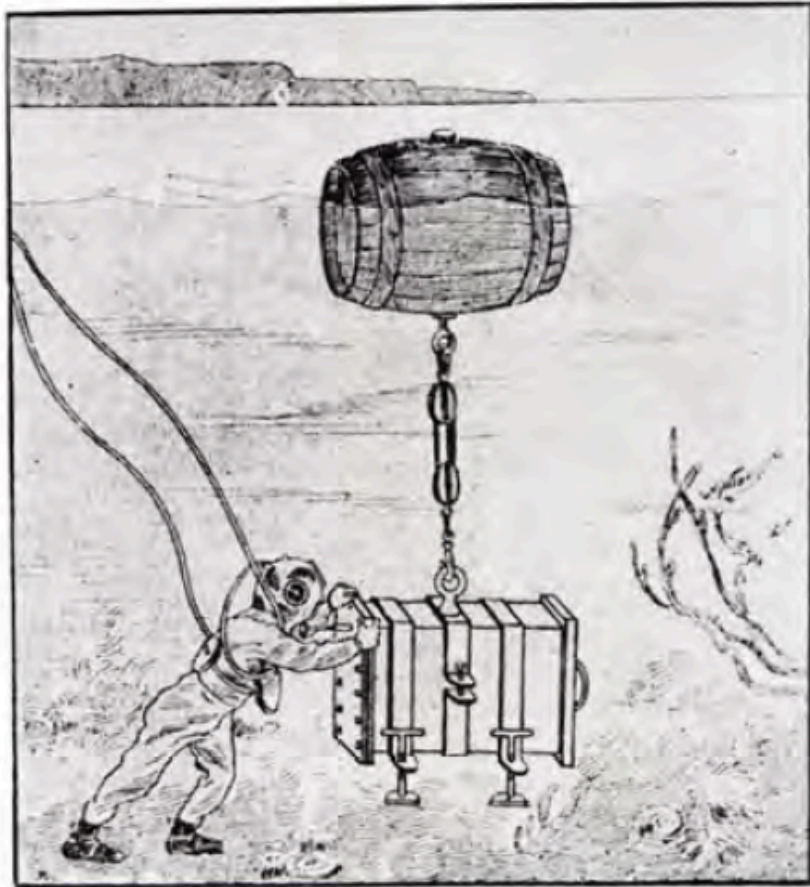
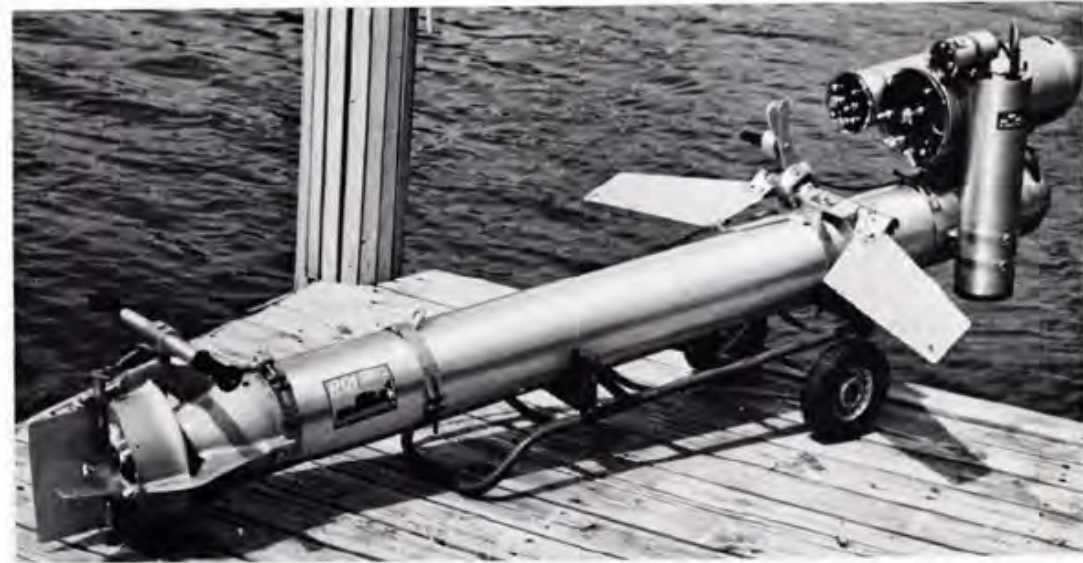

FIG. 1. Louis Boutan pushing his 8×10-inch underwater plate camera into position about 1894.



FRONTISPIECE. The latest *Pegasus* 70 mm. underwater photogrammetric system.

1967

Studies of moving objects

Muybridge, 1879 (before invention of motion picture)



Studies of moving objects

Muybridge, 1879

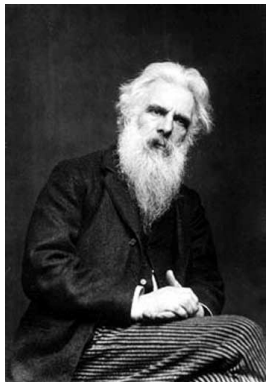
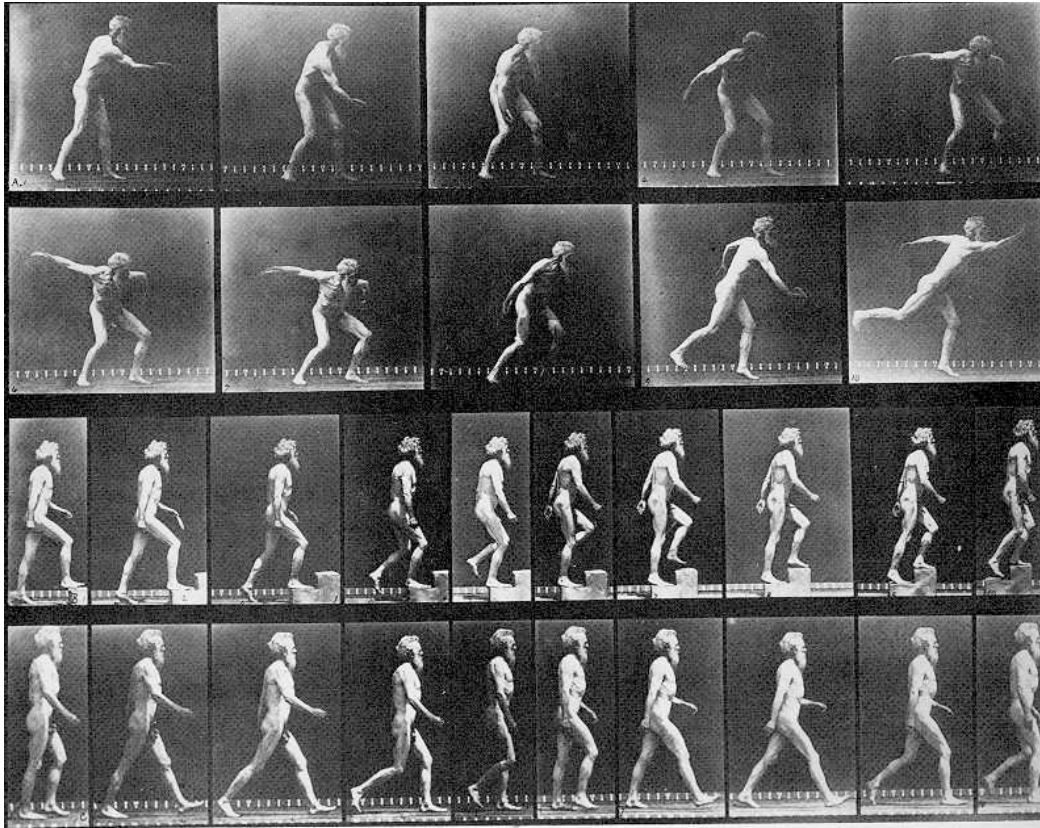

Eadweard Muybridge (1830-1904)
(born Edward James Muggeridge,
then Eduardo Santiago Muggeridge,
then Eadweard Muybridge,
pseudonym Helios)



Zoopraxiscope



Studies of moving objects

Marey, 1882: “photographic gun”

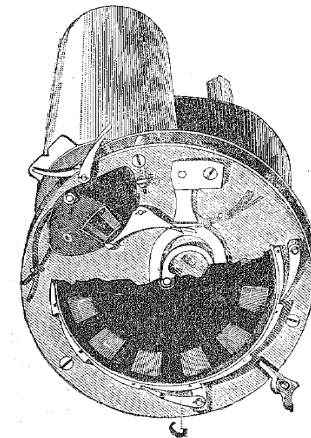
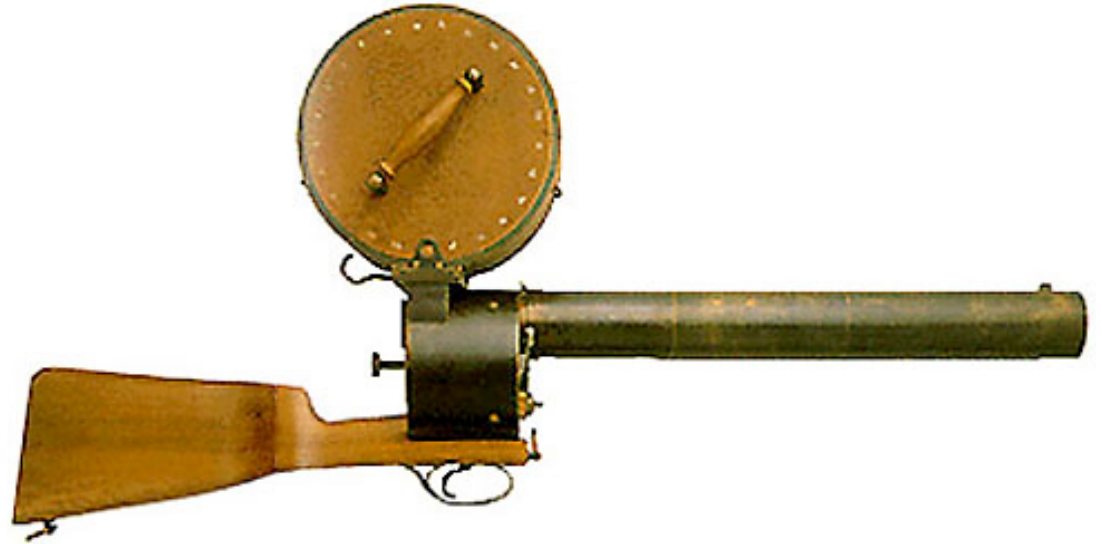
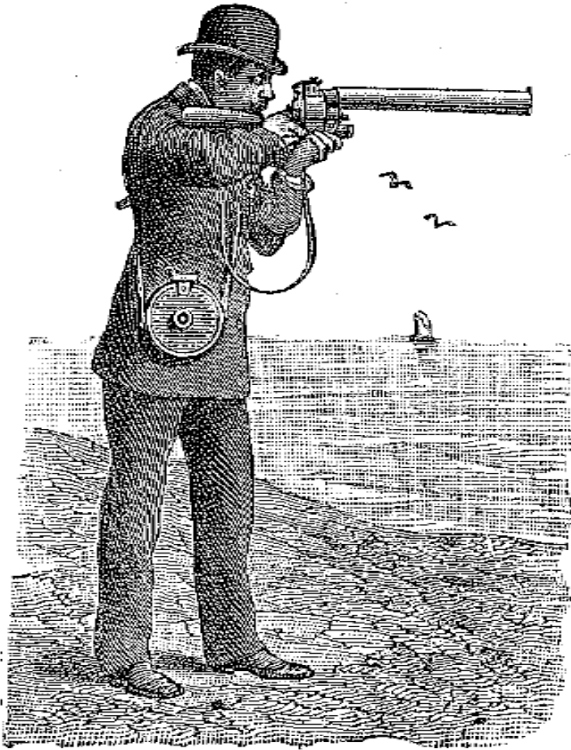

Studies of moving objects

Marey, end 19th century

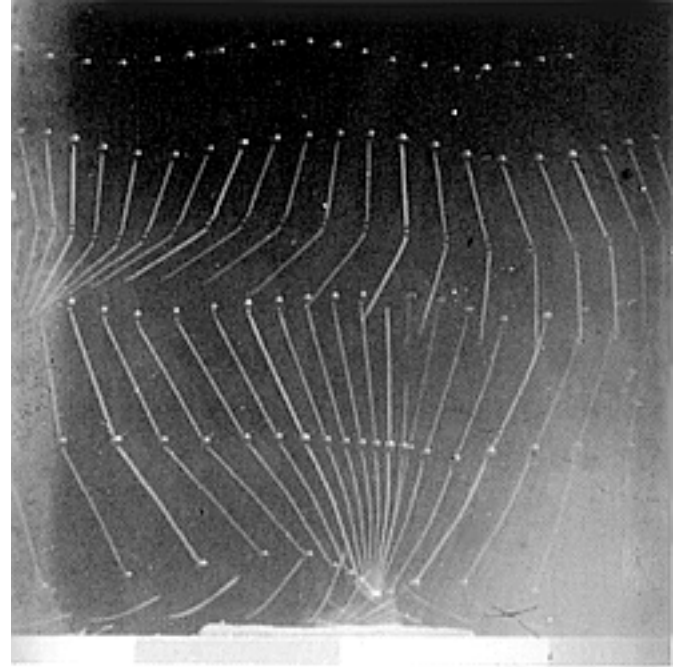

Zeller, 1952

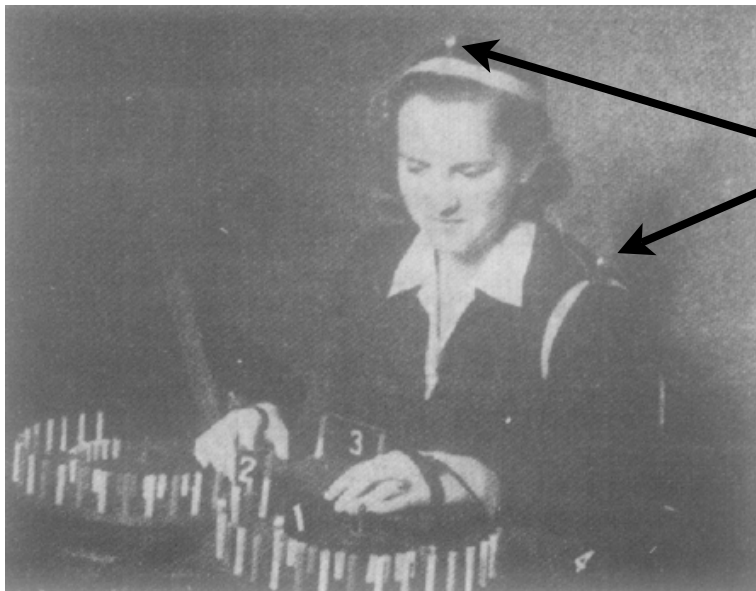

Light bulbs

Studies of moving objects

Today's motion capture

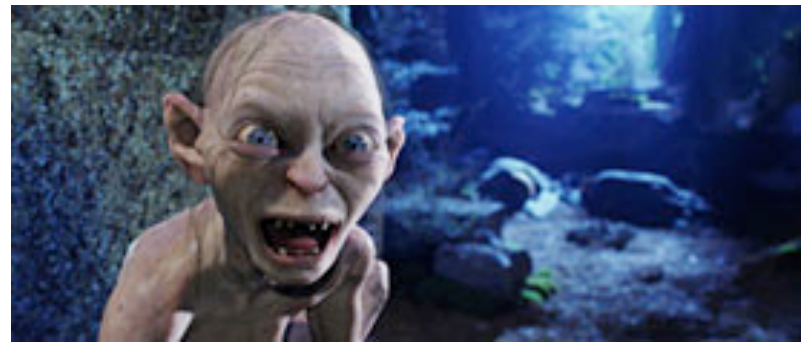

Studies of moving objects

Katzmayr, 1914: streamlines of turbulent gaz

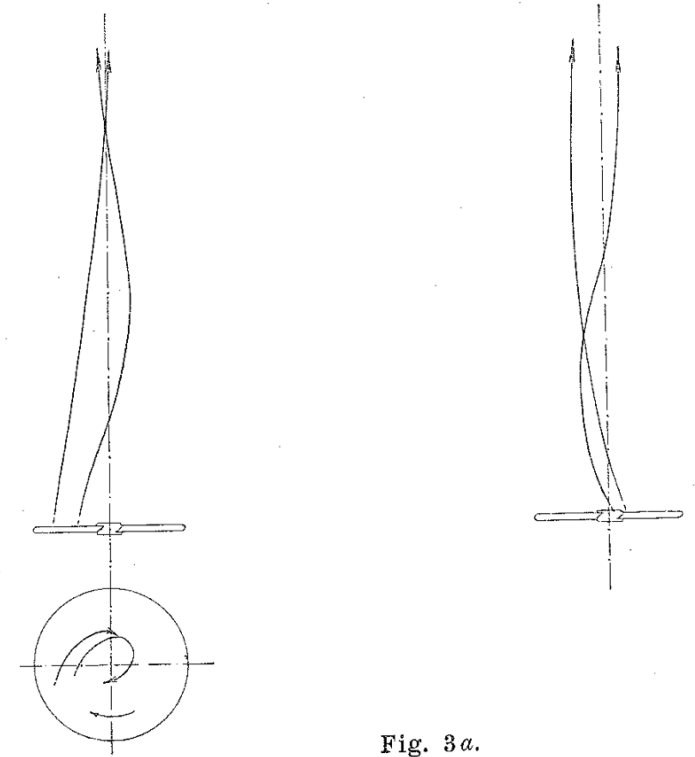
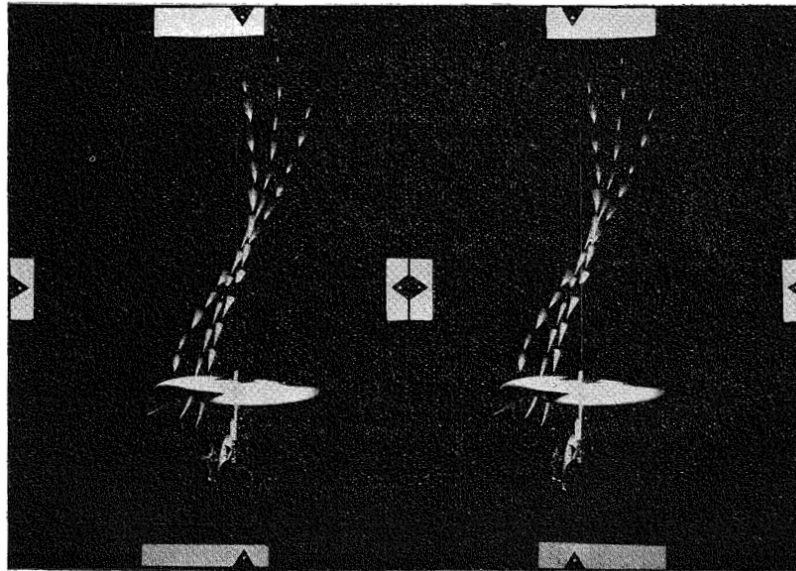
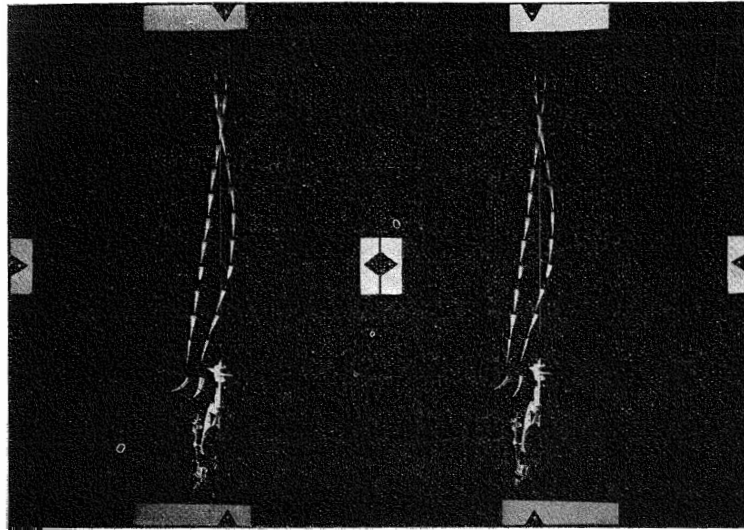

Fig. 3a.

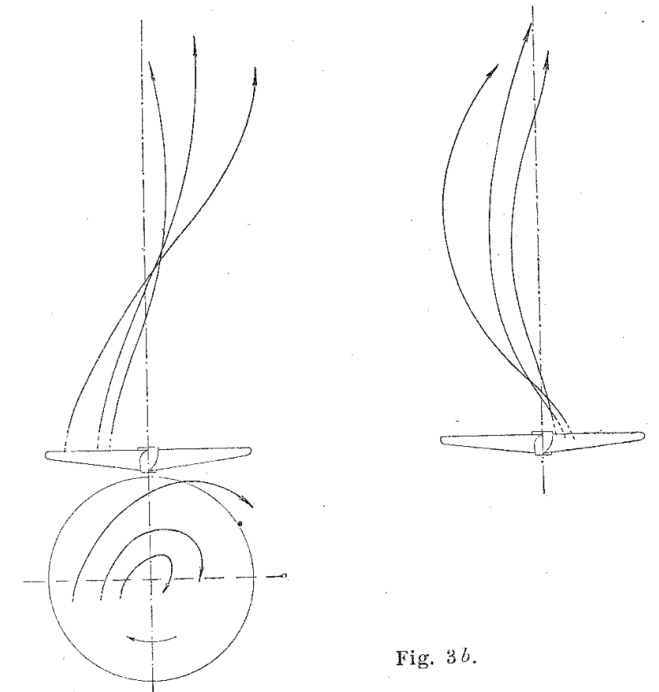
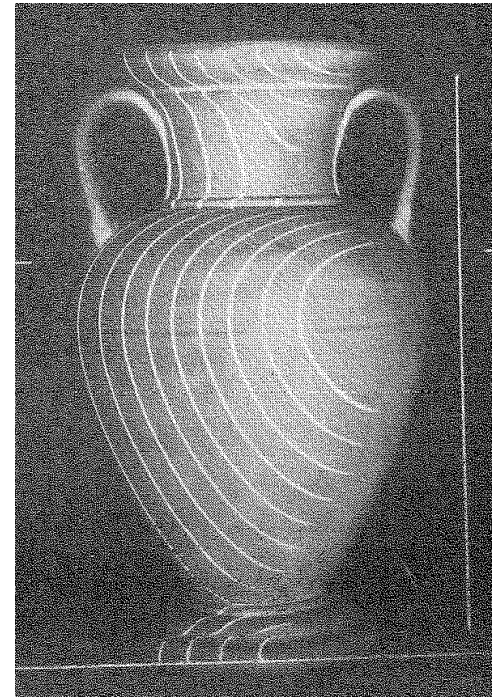
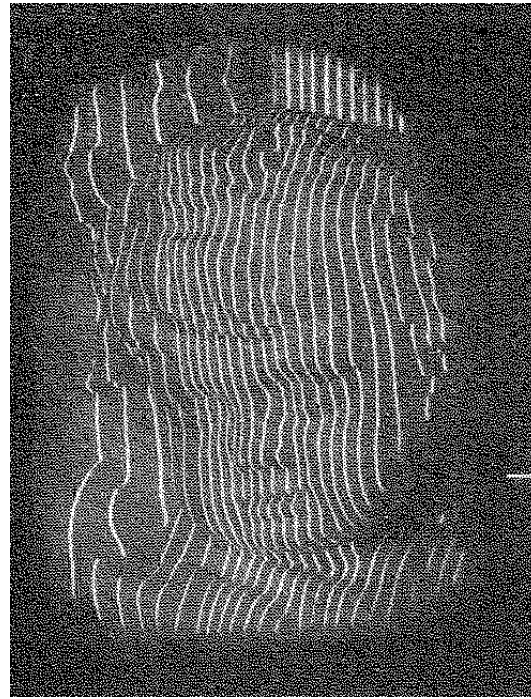
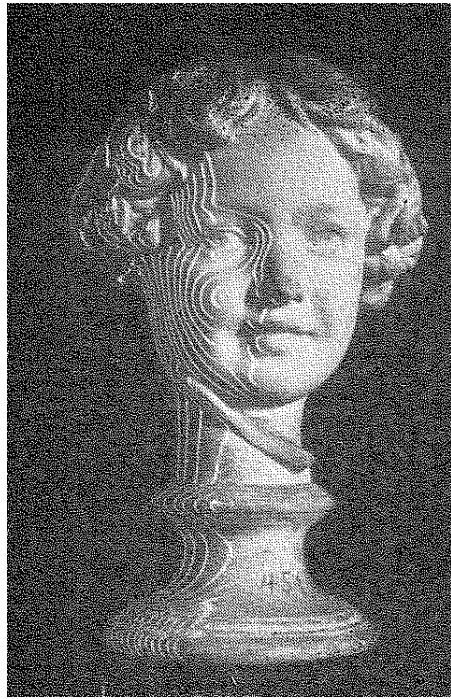
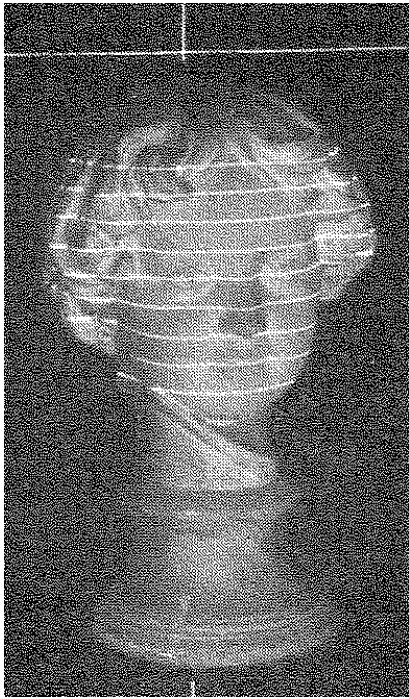

Fig. 3b.

Structured Light for 3D modeling

Zaar, 1914



Mentions also exploitation of rotational symmetry in 3D modeling and 3D modeling from shadows.

Structured Light for 3D modeling

Modern examples

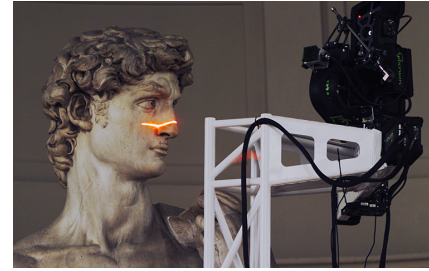
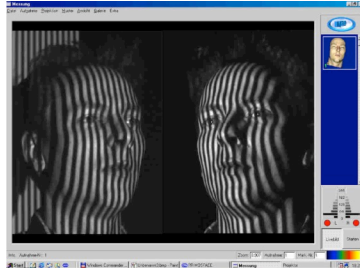
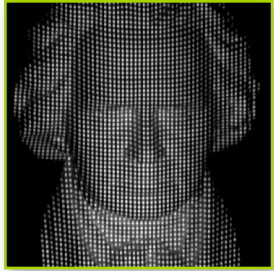

Kinect



Shape from Silhouettes / Visual Hull

Volumetric modeling by intersecting silhouette cones



courtesy of Carlos Hernández Esteban

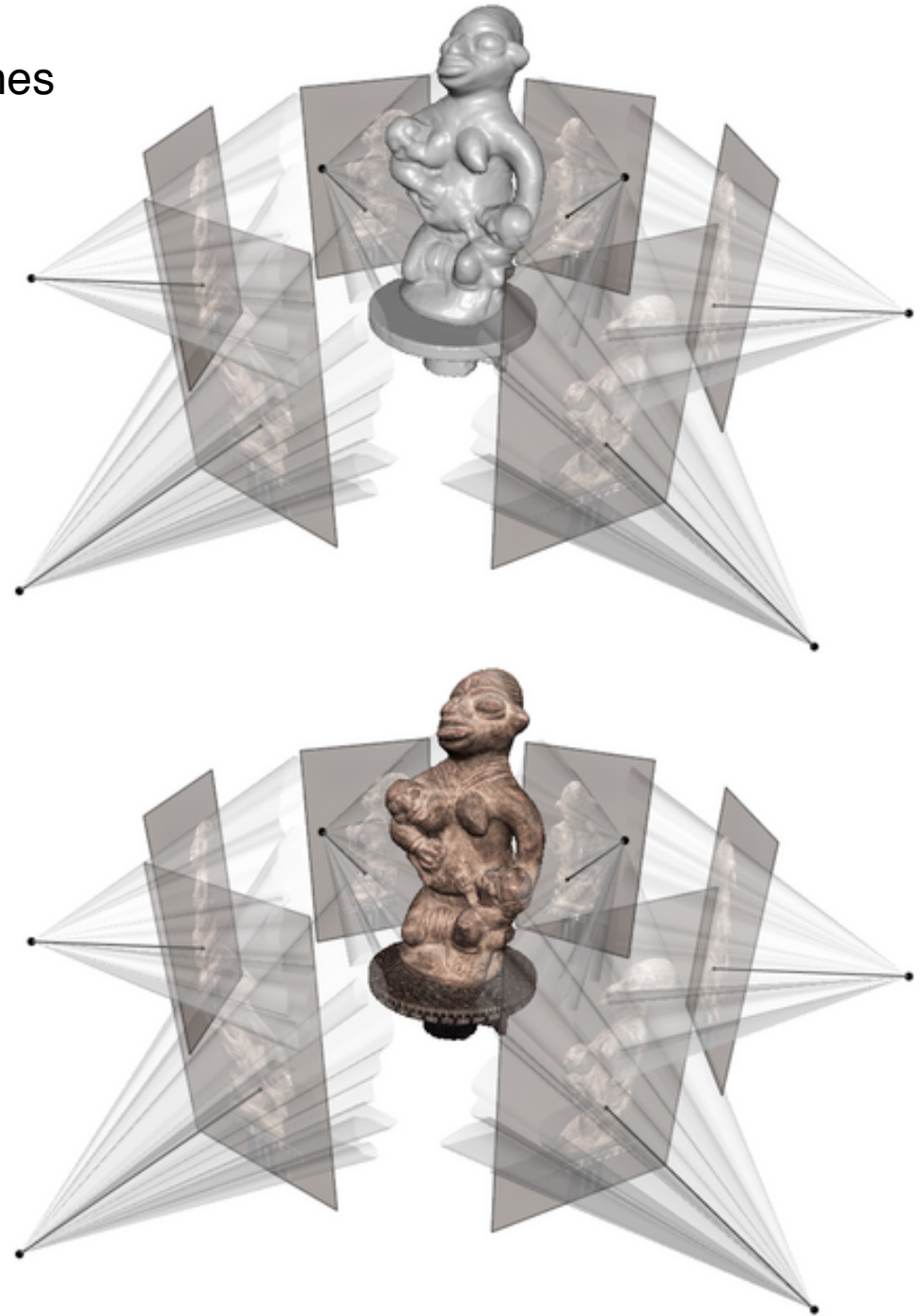

Shape from Silhouettes / Visual Hull

A “mechanical” version was developed by Willème around 1860:

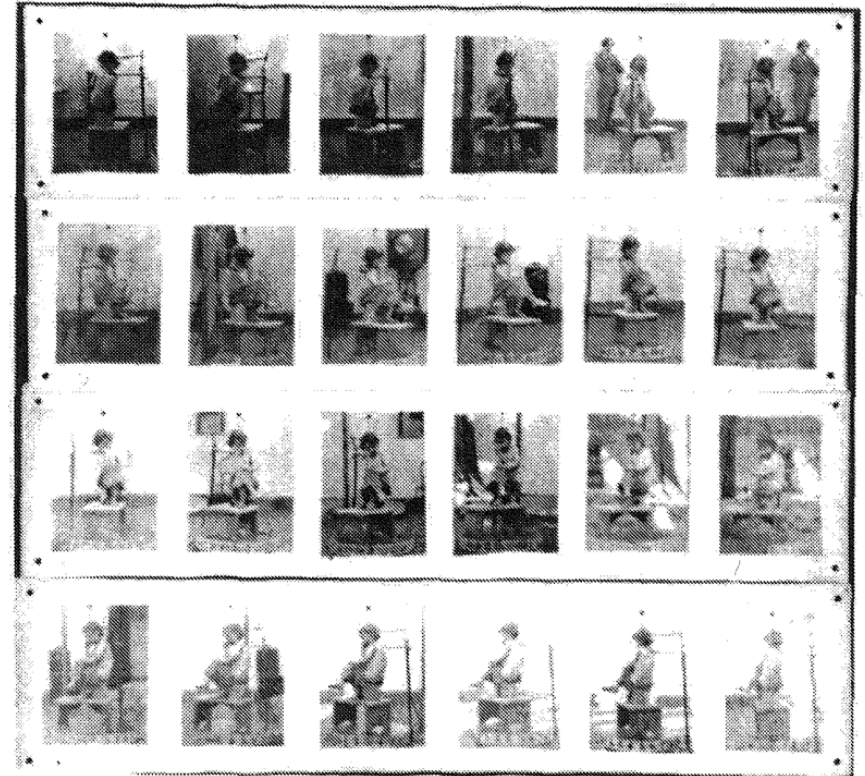
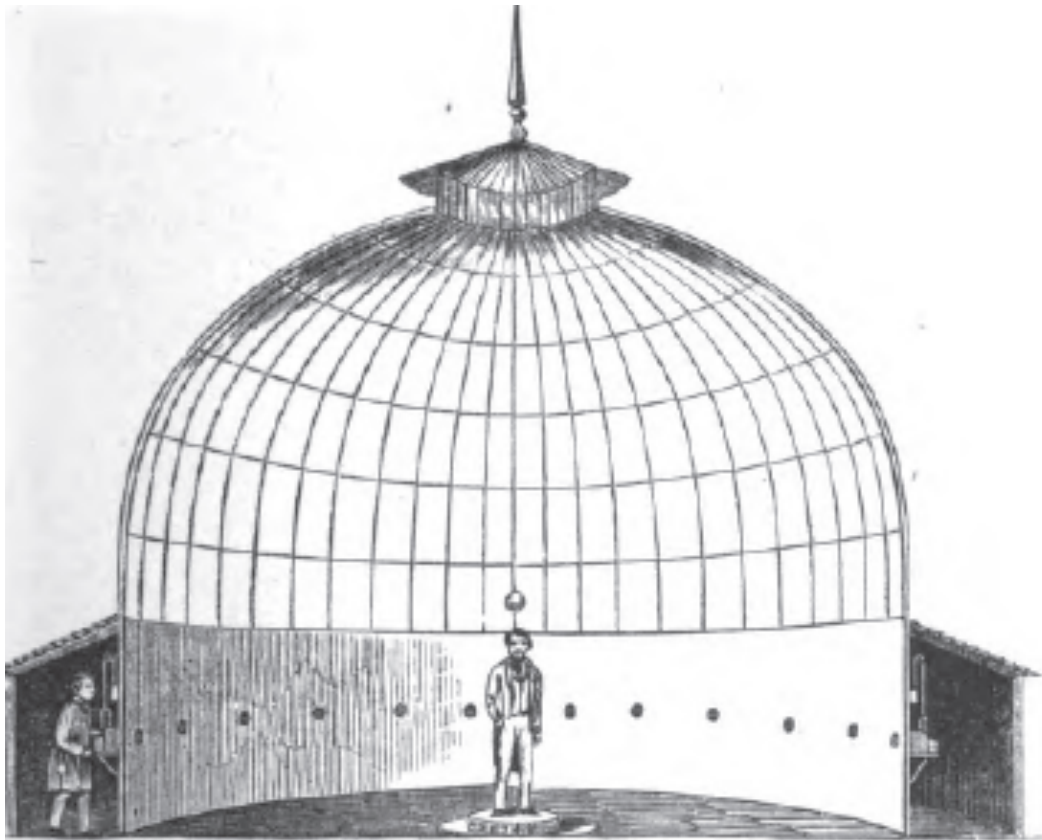

6 Willème, twenty-four sequential photographs of child model, ca. 1863-67, albumen prints. Rochester, GEH

Shape from Silhouettes / Visual Hull

A mechanical version was developed by Willème around 1860:

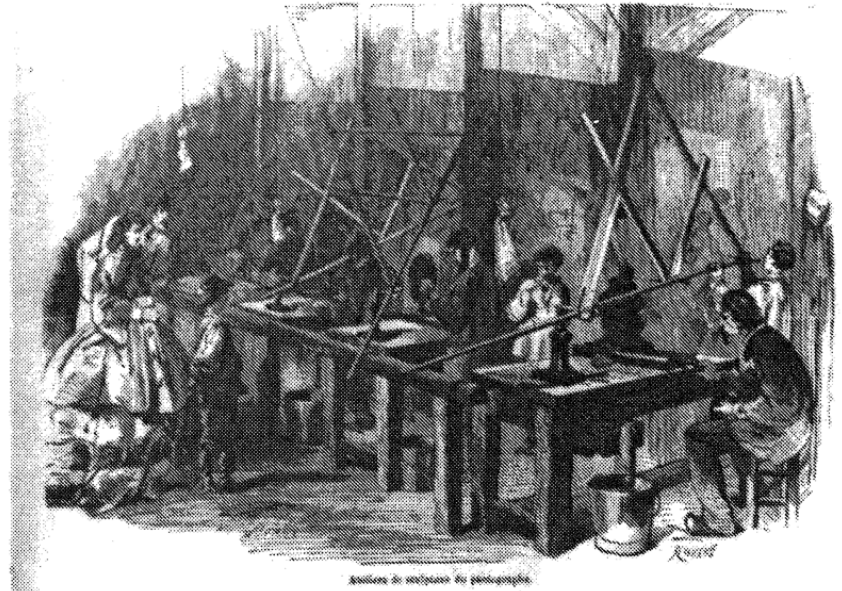
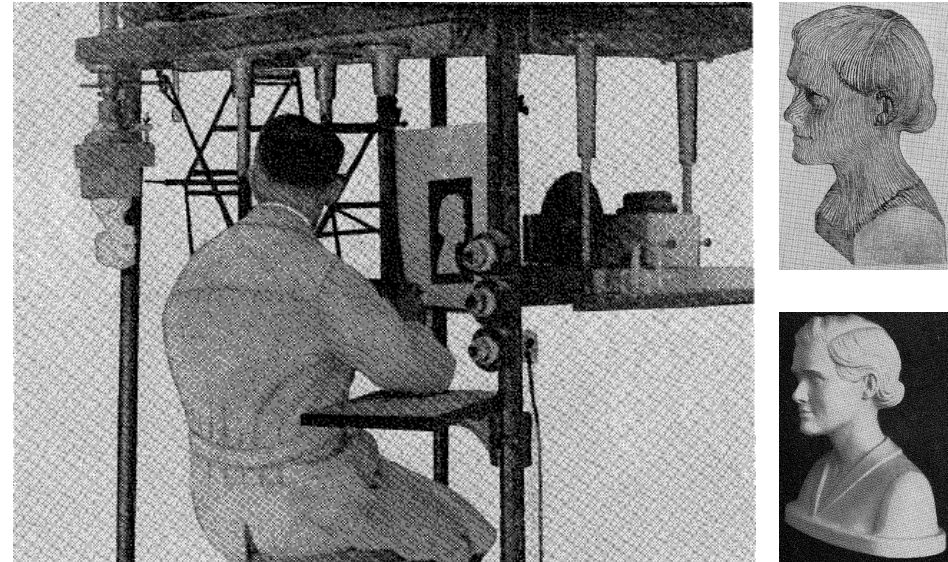
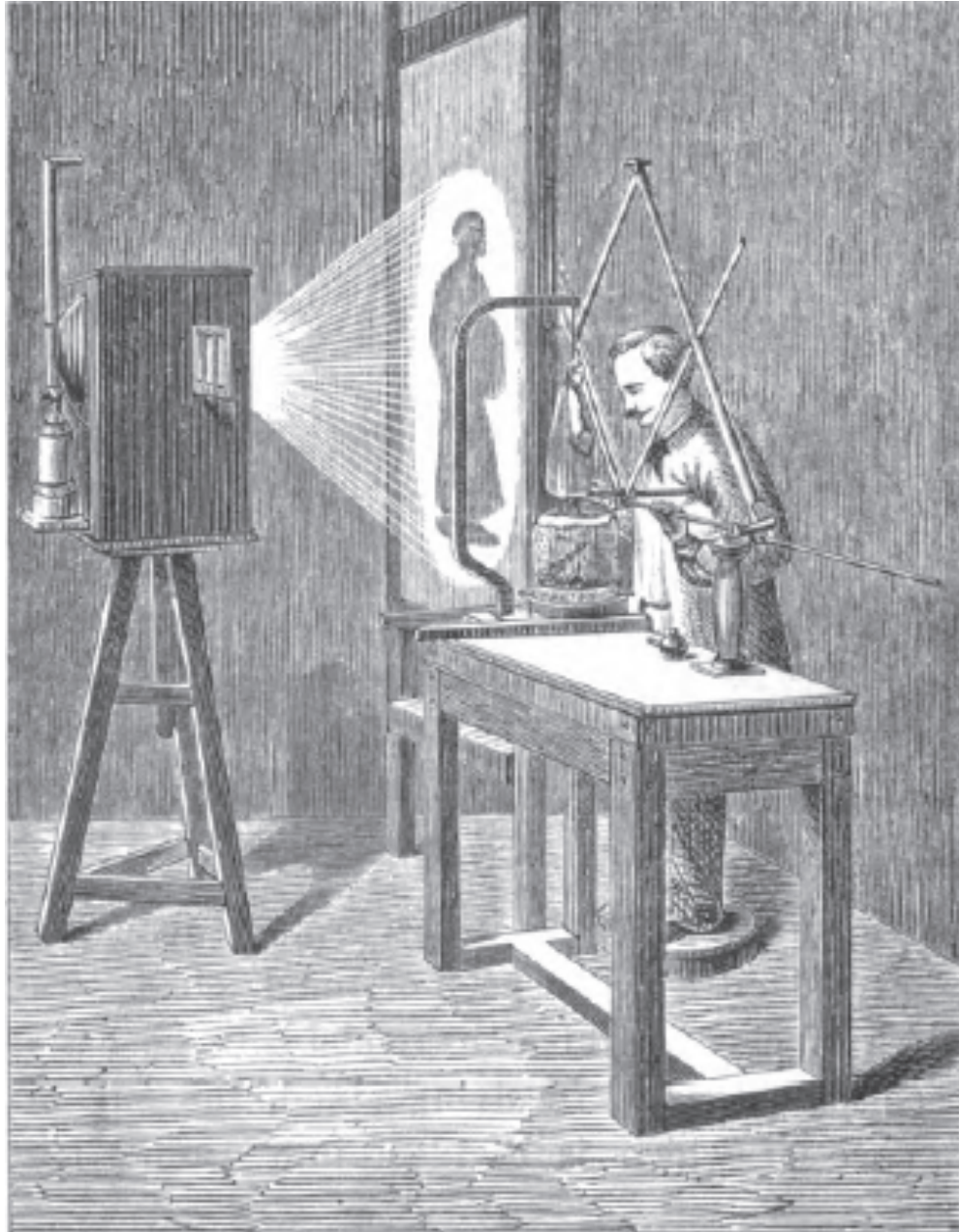

10 E. Morin and E. Rovins, pantographic studio (from *Le Monde illustré*, December 17, 1864)

Conclusions

Historical study of structure-from-motion has become a hobby of mine ;-)

What was shown is only a preliminary overview (more to come, one day...)

(I apologize for any inaccuracy)

Science and technology are often re-invented, increasingly frequently, e.g. in our area:

- panoramic image acquisition devices
- 3D modelling approaches
- analytical camera models
- structure from motion theory and algorithms

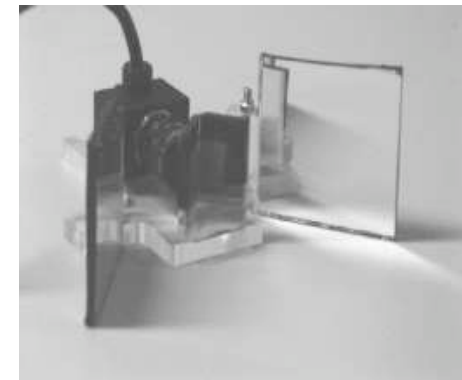

Potential reasons for this:

- sometimes because literature is spread across communities, more and more abundant and difficult to browse
- sometimes because publication pressure and frequency increases and less time is spent on literature research
- often because an application of a new theory is not known or not mature yet