



HAL
open science

Proof Nets for Intuitionistic Linear Logic: Essential Nets

François Lamarche

► **To cite this version:**

François Lamarche. Proof Nets for Intuitionistic Linear Logic: Essential Nets. [Research Report] 2008. inria-00347336

HAL Id: inria-00347336

<https://inria.hal.science/inria-00347336>

Submitted on 15 Dec 2008

HAL is a multi-disciplinary open access archive for the deposit and dissemination of scientific research documents, whether they are published or not. The documents may come from teaching and research institutions in France or abroad, or from public or private research centers.

L'archive ouverte pluridisciplinaire **HAL**, est destinée au dépôt et à la diffusion de documents scientifiques de niveau recherche, publiés ou non, émanant des établissements d'enseignement et de recherche français ou étrangers, des laboratoires publics ou privés.

Proof Nets for Intuitionistic Linear Logic: Essential nets

François Lamarche

Loria & INRIA-Lorraine
Projet Calligramme
615, rue du Jardin Botanique
54602 Villers-lès-Nancy — France
Francois.Lamarche@loria.fr

Abstract. We present a class of proof nets that are specially designed for Intuitionistic Linear Logic, for which we give a correctness criterion, as well as a cut-elimination procedure. The proof of sequentialization uses a special kind of oriented paths.

In this paper we present a class of proof objects for intuitionistic linear logic with the connectives \otimes , $-\circ$, $\&$ and $!^1$; in particular we can interpret the simply typed lambda calculus, with or without product types. We call these proof nets *essential nets*. We will formulate a correctness criterion for them: there is an *intrinsic* property that characterizes the essential nets that do come from proofs in the sequent calculus; it turns out that every such (correct) essential net represents a large number of sequent proofs that differ by inessential details. Thus essential nets, as should be the case for proof nets in general, have the power of eliminating a lot of the bureaucracy in the sequent calculus.

We will give a cut-elimination procedure for essential nets which is based on that correctness criterion. That procedure is not one that can be said to be “purely parallel”; for instance it could not be implemented solely by the means of interaction nets [7]. But we claim that there is a way to embed essential nets in a more general kind of proof nets, which we call *executable nets* that have that desirable property of parallel execution. But the present paper will be concerned solely with essential nets.

Our methods depend very strongly on the fact that we are dealing with intuitionistic linear logic (presented in a one-sided sequent fashion using the *Input* and *Output* polarities) and not the full classical system: notice that all it takes to get full linear logic is the introduction of linear negation—but that is a very big step.

It is interesting to notice that the inherent symmetry of classical linear logic, which leads to a simplified presentation that uses one-sided sequents, can be reflected back to intuitionistic fragment via the use of the *Input-Output* system of polarities (sometimes called Danos-Regnier polarities, since they first appeared

¹ In fact the constants **I** (unit for tensor) and **T** (unit for $\&$) can easily be added to the system.

in both authors' doctoral theses). We think it is J. van de Wiele who first made the remark that this system of polarities, first introduced in order to get a translation of the untyped lambda calculus into linear logic, should be seen as a discipline that restricts classical linear logic to the intuitionistic fragment. The author noticed this fact independently through the study of games semantics; it was from the start obvious that in the kind of games semantics which is used for modelling intuitionistic logic and the lambda calculus, the decision of who plays when constructing the tensor or par of two games was controlled by the same formalism as these polarities; in particular a type of polarity *Output* is modelled by a game for which Opponent begins, and it is Player who begins for types of polarity *Input*. It seems to us that the maximal fragment of linear logic which is amenable to "traditional" games semantics à la Hyland-Ong is the one treated in the present paper ² while the game-semantics aspect is covered in [8]. This logic has a strong property of "causality" which makes its representation of proofs simpler than that of anything stronger in the realm of linear logics (simply the addition of + to this is a great step up in strength/difficulty).

The point of a one-sided presentation of Intuitionistic linear logic is that it enables one to see important invariants of proofs much better; in particular the constant shuttling of formulas between the left and the right of the turnstile or which is due to the two \multimap rules in the ordinary sequent calculus disappears completely. One important examples of these invariants are the paths defined here. There have been several notions of paths in proof nets (and in their ancestors, lambda-terms) defined before. Let us say here that our paths differ from all of these; as a matter of fact they are much closer to the *trips* that are used in [4] to give the correctness criterion. Our paths are a kind of oriented version of trips, and their direction is entirely determined by the polarities. Such a kind of oriented path also appears in [10].

Let us say briefly what happens to the boxes of [4] in this paper. They do not entirely disappear, since some information about their edges is kept in the net. But this information is incorporated into the net, in a purely local manner, in the form of special *links*. For a given $\&$ -boxe the information consists in a string of *additive contraction links* of arity two. For !-boxes the information consists in a string of "boxedge" links, of arity one.

The research that produced this paper was mostly conducted in 1994; for some years a research report with almost the same title was available at the Imperial College Department of Computing web site, which had a limited circulation. The present paper differs almost only by the fact that the proofs that were missing are now included.

A lot of water has gone under the bridge since and it is natural to ask if some of the ideas and results presented here were not used or rediscovered independently in the meantime. We believe that there is one recent development in logic and the theory of proof nets which shows a clear resemblance to the present

² Some people have suggested calling this fragment Minimal Linear Logic, but we prefer to say Intuitionistic, even if sums are missing.

work, namely that associated with O. Laurent’s Polarized Linear Logic [9–11]. The *Neg-Pos* system of polarities used therein is different from ours: their motivation comes from focusing in proof search and are explicitly attached to *connectives*, while for us the polarity of a connective also depends on the polarities of its subformulas. But their reason for being is basically the same as for ours: to make explicit a form of causality in logic, that helps controlling proof reduction. While we pursued causality by restricting a known logic to its proper fragment, Laurent’s works solves the problem *by introducing a new logic*, which gives rise to many back-and-forth translations with more traditional logics. But Polarized Linear Logic is *not directly comparable* to any of these previous logics. For example all negative formulas in PLL can be contracted or weakened, so the logic does not contain a linear fragment at all, while the exponentials do not act as licensing operations for contraction and weakening as much as polarity-changing operators. But the common root of the concept of causality is visible in the fact that the paths that are used to prove correctness are oriented the same way with respect to polarity as ours: (*Output/Pos*: up, *Input/Neg*: down).

1 The Syntax

As we have said we will be using the polarities $\{Input, Output\}$, which allow the use of a one-sided sequent presentation for two-sided systems, and has shown itself to be extremely useful for dealing with intuitionistic systems. Thus *Output* means “right side of the turnstile” and *Input* “left side”. Sometimes *Output* is called positive and *Input* negative, but this clashes with other uses of positive/negative polarity systems, as seen in proof search (focusing) and Girard’s LC [3] for classical logic and its descendant, Laurent’s polarized logic [10].

We believe that they first appeared in [14] (under the names I, O) and were soon seendiscipline for doing intuitionistic linear logic using one-sided sequents. Thus, although the system we present is equivalent to intuitionistic logic with the symbols mentioned above, we have access to linear negation and we use the symbols of classical linear logic: $\otimes, \wp, \&, +, !$ and $?$. We will use the symbol \bullet to denote the polarity *Input* and \circ for the polarity *Output*. Every formula (type) of our system is assigned by induction one of these two polarities; given formula X and polarity \mathfrak{p} we write $X^{\mathfrak{p}}$ to mean “ X has polarity \mathfrak{p} ”. Given a polarity \mathfrak{p} then \mathfrak{p}^{\perp} denotes the other polarity $\mathfrak{p}^{\perp} \neq \mathfrak{p}$. If we start with a set \mathbf{V} of type variables, where typical type metavariables will be denoted by Greek letters like $\alpha, \beta \dots$ the set of atomic formulas of our system is the set

$$\mathbf{V} \times \{\bullet, \circ\}.$$

Thus an atomic formula can only be a polarized variable like $\alpha^{\mathfrak{p}}$; naturally it should be thought of as “an indeterminate formula of polarity \mathfrak{p} .” The polarity

rules for the connectives are as follows:³

\otimes	$\bullet \circ$	$\&$	$\bullet \circ$	$!$	\wp	\wp	$\bullet \circ$	$+$	$\bullet \circ$	$?$	\bullet
\bullet	\bullet	\bullet	\circ	\bullet	\bullet	\bullet	\circ	\bullet	\bullet	\bullet	\bullet
\circ	$\bullet \circ$	\circ	\circ	\circ	\circ	\circ	\circ	\circ	\circ	\circ	\bullet

where a blank entry means “undefined”. In particular in a multiple tensor $X_1 \otimes \dots \otimes X_n$ at most one of the X_i is \bullet , and dually in a multiple par $X_1 \wp \dots \wp X_n$ at most one X_i is \circ . Given a formula X^p we define its orthogonal $(X^\perp)^{p^\perp}$ as usual: $(X \otimes Y)^\perp = X^\perp \wp Y^\perp, \dots (\alpha^p)^\perp = \alpha^{p^\perp}$, etc. These connectives have the same introduction rules as in ordinary linear logic, except that we have the right to introduce a connective only when it respects the polarity tables above. We will consider two systems that differ only in their axiom sequents: in the first one (the $\beta - \eta$ system), the only axiom sequents have the form $\vdash \alpha^\bullet, \alpha^\circ$ for a type variable α . In the other one (the β system) we take for axioms all sequents $\vdash X, X^\perp$, where X is any formula.

Since the multiplicatives may have both polarities, we split a given multiplicative connective in two new connectives, each with an unambiguous polarity; these new connectives are distinguished by simply adding the polarity information. For example the connective \otimes^\bullet can only be applied to a pair of formulas that have distinct polarities, while the connective \otimes° can only be applied to two formulas of polarity \circ .

From now on, whenever a formula $W \otimes^\bullet Z$ is used, we will always have W° and Z^\bullet , and whenever $W \otimes^\circ Z$ it will be W^\bullet and Z° . Since the multiplicatives are commutative, there is obviously no loss of generality in this; this restriction can be seen as the removal of one entry in each multiplicative polarity table.

When the cut rule is used we keep track of the formulas that have been cut, inside square brackets, pretty much as in [5]. There is a little difference though, in that, as in [15], we think of the cut rule as introducing a pseudo-connective ct , of polarity \bullet . Thus a sequent in general looks like $\vdash X_1^\bullet, \dots, X_n^\bullet, Y^\circ [Z_1, \dots, Z_m]$, where all the Z_j have ct as their last connective, and none of the X_i, Y do. The cut rule is

$$\frac{\vdash \Gamma, Z^\circ [\Delta] \quad \vdash Z^\perp, \Gamma' [\Delta']}{\vdash \Gamma, \Gamma' [\Delta, \Delta', Z \text{ct} Z^\perp]}$$

Notice that a “ ct -introduction” is very much like a \otimes^\bullet -introduction, in particular we use the same typing convention for both connectives: the cut formula^o is at the left and the other one at the right. Naturally, a formula “introduced” by a cut is out of commission. Unsurprisingly, this process of taking the sum of Δ, Δ' will happen for the other binary rules: $\otimes^\bullet, \otimes^\circ$ and $\&$.

Proposition 1. *Let $\vdash X_1, \dots, X_n$ be a provable sequent of the system. Then there exists a unique i such that X_i° .*

The proof is a very easy induction. \square

³ Our notation is absolutely standard except that we cannot bring ourselves to using \oplus for “plus”, something we think people with a training in category theory will sympathize with.

The meaning of this is that a provable sequent $\vdash X_1^\bullet, \dots, X_n^\bullet, Y^\circ$ is always equivalent to a multiple premiss-single conclusion sequent $X_1^\perp, \dots, X_n^\perp \vdash Y$ where all the formulas involved have polarity \circ . Thus we should think of these formulas as the ones that are really relevant to the logic, while those of the opposite polarity are only their *formal negation*.

The connection with ordinary intuitionistic linear logic can be completely formalized as follows: let us call an *ordinary* formula one which is built using *unpolarized* variables like α, β and the unpolarized connectives $\otimes, \multimap, \&, !$. An *ordinary sequent* is a two-sided, one-conclusion sequent of ordinary formulas, and an *ordinary proof* of an ordinary sequent is one that uses the most standard version of ILL, with a one-conclusion two-sided sequent system (intuitionistic sequents) and the standard rules for our choice of connectives in that system.

Until the end of this section we polarize all the connectives of our one-sided system, e.g. we write $\&^\circ$ or $!^\circ$ to distinguish them from the ordinary ones.

There is a standard translation $(-)^b$ of ordinary formulas into our system:

$$\begin{aligned} \alpha^b &= \alpha^\circ & (X \otimes Y)^b &= X^b \otimes^\circ Y^b \\ (!X)^b &= !^\circ X^b & (X \& Y)^b &= X^b \&^\circ Y^\circ \\ (X \multimap Y)^b &= (X^b)^\perp \wp^\circ Y^b \end{aligned}$$

The polarity tables ensure that every formula of the form X^b has polarity \circ ; it turns out that this translation is a *bijection* from the set of ordinary formulas onto the set of formulas of that polarity. Given X° in our system, there is a unique ordinary X^\sharp such that $X^\sharp{}^b = X$.

If X is an atomic α° we take $X^\sharp = \alpha$. If $X = !X'$ we take $X^\sharp = !(X'^\sharp)$. If neither of these hold X is of the form $X_1^\circ \diamond X_2^\circ$ and \diamond can only be $\otimes, \&, \wp$. In the first and second case the polarity rules tell us that X_1° and X_2° , and thus $X^\sharp = X_1^\sharp \diamond X_2^\sharp$. In the third case the polarity rules (along with the convention above on the use of \wp°) tell us that X_1^\bullet, X_2° . We just take $X^\sharp = (X_1^\perp)^\sharp \multimap X_2^\sharp$. \square

Proposition 2. *A sequent $\vdash X_1^\perp, \dots, X_n^\perp, Y^\circ$ is provable in the one-sided system if and only if $X_1^\sharp, \dots, X_n^\sharp \vdash Y^\sharp$ is provable in the ordinary two-sided system (here X_i^\bullet always).*

The proof is simply the construction of a bijective correspondence between the sets of introduction rules of the two calculi, the one- and the two-sided. In the two-sided sequent a connective has two introduction rules, left and right; this is replaced in the one-sided system by *two* connectives, one of polarity \circ for the right rule and its dual for the left rule. The correspondence is as follows:

two-sided	one-sided- \circ	one-sided- \bullet
\otimes	\otimes°	\wp^\bullet
\multimap	\wp°	\otimes^\bullet
$\&$	$\&^\circ$	$+\bullet$
$!$	$!^\circ$	$?\bullet$

Let us give an example of how the correspondence goes. For \multimap , the introduction rules

$$\frac{\Gamma^\#, X^\# \vdash Y^\#}{\Gamma^\# \vdash X^\# \multimap Y^\#} \text{ and } \frac{\Gamma^\# \vdash Z^\# \quad \Delta^\#, X^\# \vdash Y^\#}{\Gamma^\#, \Delta^\#, Z^\# \multimap X^\# \vdash Y^\#}$$

has the following counterpart

$$\frac{\vdash \Gamma^\perp, X^\perp, Y}{\vdash \Gamma^\perp, X^\perp \wp^\circ Y} \text{ and } \frac{\vdash \Gamma^\perp, Z \quad \vdash \Delta^\perp, X^\perp, Y}{\Gamma^\perp, \Delta^\perp, Z \otimes^\bullet X^\perp, Y}$$

respectively. \square

2 Essential Nets

In what follows we will be dealing with several forest and tree structures. According to our favored definition a *forest* is a pair (\mathbf{F}, pr) where pr is a partial function (called the *predecessor*) on the set \mathbf{F} (we call the $x \in \mathbf{F}$ such that their predecessor is undefined the *roots* of \mathbf{F}) subject to the axiom

For every $x \in \mathbf{F}$ there exists $n \geq 0$ such that $\text{pr}^n(x)$ is a root.

A forest that has a unique root is called a *tree*. Given y such that $\text{pr}(y) = x$ we say that y is a *successor* of x . A forest has a natural order structure, given by

$$x \leq y \text{ iff there exists } n \geq 0 \text{ with } x = \text{pr}^n(y).$$

It is well-known that this ordering determines the predecessor function:

$$\text{pr}(x) = \text{The greatest } y \text{ with } y < x.$$

Also well-known is the fact that an ordering \leq on a set \mathbf{F} is obtained as above from a predecessor function iff for every $x \in \mathbf{F}$ the set $x \downarrow$ of elements below x is a finite total ordering. The forest is a tree iff the ordering has a least element. A standard way to construct a forest or a tree is as a set of *nonempty* words, i.e. as a subset $\mathbf{F} \subset \mathcal{A}^*$ of the free monoid generated by an alphabet \mathcal{A} , closed under the prefix relation. Order is then prefix and predecessor the removal of the last element. We require that all words of \mathbf{F} be nonempty, so that roots are words of length one.

Given a formula X we denote its set of occurrences of subformulas by $\mathbf{O}(X)$; this set has a natural tree structure for which the predecessor is denoted $\text{pr}_{\mathbf{O}}$ and the order $\leq_{\mathbf{O}}$; at the root of the tree is X , and at the leaves the atomic (occurrences of) subformulas. Thus $X \leq_{\mathbf{O}} Y$ means “ Y is a subformula of X ”. We are often a bit vague about the distinction between an occurrence of a subtype (or subformula) and that very subformula; this very common abus de notation is not dangerous if used wisely. If $S = \vdash \Gamma[\Delta]$ is a sequent we take $\mathbf{O}(S)$ to be the forest of occurrences of subformulas in S , i.e. the disjoint union of the trees

$\mathbf{O}(X_i)$ and $\mathbf{O}(Z_j)$ if S is $\vdash X_1, \dots, X_n[Z_1, \dots, Z_m]$. If $a \in \mathbf{O}(S)$ and the last connective introduced in a is \diamond we say a is a \diamond -occurrence.

As usual in linear logic a proof net for us will be a certain structure which is obtained by assembling *links* according to certain rules. But our treatment of the links that are “on top” of the net (those associated to axioms and weakenings) will differ slightly from the current practice. The reason is that we want to emphasize the natural forest structure that proof nets have, but because of things like axiom links this structure is not enough to fully describe the net.

We first define a *tree of links* to be a tree (\mathbf{A}, pr) every one of whose nodes is labeled with one of the following:

$$\mathbf{x}^\bullet, \mathbf{x}^\circ, \otimes^\bullet, \otimes^\circ, \wp^\bullet, \wp^\circ, \&, +_l, +_r, ?, \wr, \mathbf{c}, !, \mathbf{i}, \mathbf{!}, \mathbf{a}, \text{ct}$$

There are typing and arity conditions a tree of links has to obey; in particular the trees of links we are interested in come equipped with a function Type that assigns a type to every node. Table 1 gives the arity and typing rules in full.

Thus every link has an arity, whose value should be clear from the table. The typing rules displayed with the links are presented in a “pattern matching” form, where X^p, Y^p can be any types of polarity p ; the trees they allow us to construct have leaves that are the 0-ary links; notice that for $+_r, +_l, \wr$ and the 0-aries the link alone is not enough to make the type unambiguous and so additional information (shown in parentheses) is necessary. In other words the type of a node is not entirely determined by the type of the nodes above it; the stuff in parentheses indicates the “leeway” that is allowed to the typing function. In accordance with what we have said on the cut rule, if a ct -link appears in a tree it is the root.

Notice that every link has a polarity assigned to it, since whatever the type associated with a link, its polarity will be invariant. Let (\mathbf{A}, pr) be such a well-typed tree and let X be its type, that is, the type of its root. There is a uniquely defined function $\rho: \mathbf{A} \rightarrow \mathbf{O}(X)$ that maps a link to an occurrence of the same type; we will not say more about the definition of ρ except that given $x \in \mathbf{A}$ such that $\text{pr}(x)$ is defined we either have $\rho(\text{pr}(x)) = \rho(x)$, when $\text{pr}(x)$ is one of the two contraction links, $\mathbf{a} \wr$ or $\mathbf{a} \mathbf{!}$, or we have $\rho(\text{pr}(x)) = \text{pr}_{\mathbf{O}}(\rho(x))$ in all the other cases. Given $x \in \mathbf{A}$ such that $\rho(x) = Z$ we say that x is *above* Z . Another property which should be entirely obvious is that the number of successors of x is exactly the arity of the *link* x , not to be confused with the arity of the last connector in $\rho(x)$; they agree only some of the times. One interesting point is that ρ determines exactly to what extent in a binary link one should make the difference between “left” and “right”. That is, in a case like \otimes the two successors of a link are above different occurrences and therefore we can tell the difference between left and right; while for \mathbf{a} and \mathbf{c} both successors are above the same occurrence and indeed at this point we are not interested in knowing which one is the “left successor” and which one is the “right successor” of a contraction link.

Similarly we can define a *typed forest of links*, as a forest \mathbf{A} which is a disjoint union of typed trees as above. Then there is a multiset $S_{\mathbf{A}}$ of formulas, the sum

Table 1. Links

<p>binary introductions</p>	
<p>unary introductions</p>	<p>+introduction to the right +introduction to the left !-rule (promotion) dereliction</p>
<p>0-ary</p>	<p>half of axiom half of axiom weakening</p>
<p>miscellaneous</p>	<p>•-edge of !-box o-edge of !-box contraction additive contraction</p> <p>cut</p>

of the types of the roots, and a function $\rho: \mathbf{A} \rightarrow \mathbf{O}(S_{\mathbf{A}})$. Notice that ρ restricted to the roots is a bijection, also that ρ trivially respects the polarities. We will call the links $\otimes^\circ, \otimes^\bullet, \wp^\circ, \wp^\bullet, \&, +_l, +_r, !, ?$ the *type-structural* links. They are the one that modify the type: to each connective in the system is associated one (two in the case of $+$) type-structural link. Notice also that the only links of polarity \circ which are not type-structural are \mathbf{x}° and $!$.

But here we have to be more precise about what we mean by multiset:

Definition 1. *Let \mathbf{B} be a set. A strong multiset over \mathbf{B} is a finite “underlying” set whose elements are decorated with elements of \mathbf{B} . A weak multiset over \mathbf{B} is a function $\mathbf{B} \rightarrow \mathbb{N}$ whose value is zero everywhere but a finite number of elements of \mathbf{B} .*

We need to make the distinction because we will need both kinds of multisets in this paper. Strong multisets are sets-with-structure; in particular *they can have permutations*. Given \mathbf{B} and a strong multiset S over \mathbf{B} there is a weak multiset over \mathbf{B} that corresponds to it, which counts the number of times every label appears in S , but forgets the distinction between the elements of its underlying set: some amount of information has been lost. We emphasize that in the paragraph above $S_{\mathbf{A}}$ is meant to be a *strong* multiset, and that there is a canonical choice for its underlying set: for example just take the set of roots of \mathbf{A} . When we say that a sequent is a multiset of formulas, we still want to be able to distinguish the instances of a given formula if it appears more than once, because a proof net structure (as a matter of fact, *any* formal representation of a proof, say a derivation tree) needs to do so. Strong multisets allow us to avoid representing sequents as ordered lists of formulas, eliminating a lot of bureaucracy associated with the Exchange rule.

If the reader thinks we are overly pedantic with these fine distinctions, he should be reminded that weak multisets are absolutely unsuitable for representing sequents in commutative logics (because they eliminate the distinction between two occurrences of the same formula) but that some authors nonetheless have used them in papers on linear logic.

Weak multisets will be needed for the proof of strong normalization.

We can now give the first big definition:

Definition 2. *Given a sequent*

$$S = \vdash X_1^\bullet, \dots, X_n^\bullet, Y^\circ [Z_1^\bullet, \dots, Z_m^\bullet]$$

an essential net⁴ over S is a quadruple $(\mathbf{A}, \text{pr}, \rho, \xi)$, where \mathbf{A} is a typed forest of links, such that $S = S_{\mathbf{A}}$. As we have said we consider sequents as strong multisets of formulas; we denote the forest order on \mathbf{A} by \leq and ρ is just as above. The forest \mathbf{A} is subject to the requirement that every $!$ -link has a $!$ -link for predecessor, and conversely every $!$ -link has a $!$ -link for (unique) successor.

⁴ We have to say we much prefer the terminology (essential) net/correct net to the usual proof structure/proof net.

It is useful to think of a $!-!$ pair as a single link that has two halves: a top and a bottom one.

ξ is a function defined on the set of leaves of \mathbf{A} of polarity \bullet , and it takes for values links of polarity \circ ; we require that the restriction of ξ on the set of \mathbf{x}^\bullet -links be a bijection whose image is the set of \mathbf{x}° -links, and such that if an \mathbf{x}^\bullet -link has type X^\bullet then $\xi(x)$ has type X^\perp : we are just saying that the restriction of ξ to \mathbf{x} -links encodes the information contained in the axiom links, in the terminology of [4]. The other conditions that ξ is required to obey is that $\xi(x)$ never be \leq -below x , and never be a $\&$ - or $!$ -link. We say that the roots of \mathbf{A} above the X_i and Y are the active roots: a cut always deactivates two roots.

Proposition 3. *Let \mathbf{A} be a forest of links and $x, x' \in \mathbf{A}$.*

1. *If x°, x'° are \leq -related and $\rho(x) = \rho(x')$ then either $x = x'$ or one is a $!$ and the other one a $!$.*
2. *If a $\leq_{\mathbf{O}}$ $\rho(x)$ is a \diamond -occurrence there exists a unique type-structural link $x' \leq x$ associated to \diamond with $\rho(x') = a$.*

The proofs are very easy. \square

It is time to describe how a net is constructed from a proof. We put a very slight restriction on the Weakening rule: given an occurrence of Weakening

$$\frac{\vdash \Gamma^\bullet, Y^\circ [\Delta]}{\vdash ?X, \Gamma, Y [\Delta]}$$

we ask Y *not* to have $\&$ as outermost connective. We call such occurrences of uses of Weakening (when the Output formula is a with-formula) *forbidden* Weakenings.

Proposition 4. *Let P be a derivation. Then there exists another derivation P' with the the same conclusion such that no forbidden Weakening happens.*

Proof. We first prove the following restricted case: given a derivation P whose last rule is a forbidden Weakening and that contains no other such, there exists a P' with the same conclusion but where the occurrence of Weakening has been pushed above the $\&$ -introduction, perhaps with some duplications.

The proof P' is constructed by the following algorithm:

- If the next-to-last rule is the $\&$ -introduction, then move the Weakening up in the two branches of that introduction, and we are done.
- If the next-to-last rule is not a $\&$ -introduction, the only way it can be a binary rule is if it introduces a \otimes^\bullet . Then push the Weakening above in both branches. In both these branches the formula $^\circ$ is still Y so we iterate.
- If the next-to-last rule is not binary, it is necessarily unary (it obviously cannot be an axiom), and either introduces a formula $^\bullet$ or is a case of Contraction (it cannot be a Weakening, because it is forbidden, which is ruled out by assumption). Then our Weakening can be easily moved above that rule application. The formula $^\circ$ is still Y so we iterate.

The general case follows easily, since that procedure can be applied repeatedly, always working on a forbidden application of Weakening which is maximal in the derivation tree. \square

In the rest of the paper we assume that all derivations are in that particular form, where Weakening is never applied when the conclusion formula is a $\&$.

From now on until further notice \mathbf{A}, \mathbf{A}' are nets over the sequents

$$\begin{aligned} S &= \vdash X_1^\bullet, \dots, X_n^\bullet, Y^\circ [Z_1^\bullet, \dots, Z_m^\bullet] \\ S' &= \vdash X'_1, \dots, X'_{n'}, Y'^\circ [Z'_1, \dots, Z'_{m'}] \end{aligned}$$

respectively, and the lower case letter corresponding to a formula denotes the root above that formula: e.g. x_3 is the root above X_3 , z'_2 the root above Z'_2 , etc.. In the diagrams below we tend to show only the active roots of our nets.

- The net associated with the axiom sequent $\vdash X^\bullet, X^{\perp\circ}$ is as follows:

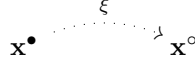

and will be usually represented as

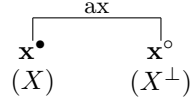

but the information in parentheses is omitted in the great majority of the times.

- If the \wp^\bullet -rule is applied on \mathbf{A} to X_1, X_2 the resulting net is obtained by just adding a \wp^\bullet -link below x_1, x_2 .

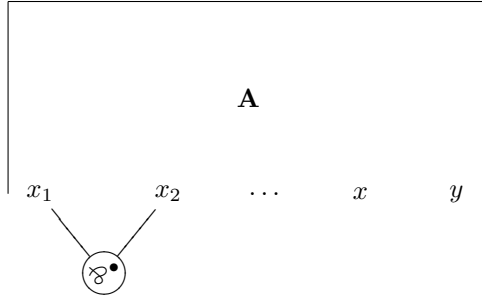

The same goes if it the \wp° -rule which is applied, say to X_i, Y , except that this time it is a \wp° that is added below x_i, y .

- If the \otimes^\bullet -rule is applied on S, S' to Y, X'_1 , giving the sequent $\vdash \Gamma, Y \otimes^\bullet X_1, \Gamma', Y' [\Delta, \Delta']$ the resulting net is the disjoint sum of \mathbf{A}, \mathbf{A}' (the

definition of ξ on the sum is obvious) with a \otimes^\bullet -link added under y, x'_1 .

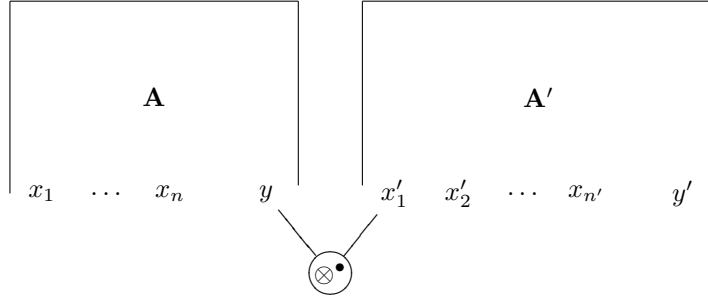

The same thing happens, mutatis mutandis when the \otimes° -rule is applied on **A, A'**.

- Let the $\&$ -rule be applied on **A, A'**, yielding the sequent $\vdash \Gamma, Y \& Y' [\Delta, \Delta']$. This rule forces $n = n'$, and by rearranging things one can assume $X_i = X'_i$, $i \leq n$. The resulting net is the disjoint sum of **A, A'**, with an **a**-link added under each pair x_i, x'_i , and a $\&$ -link added under y, y' .

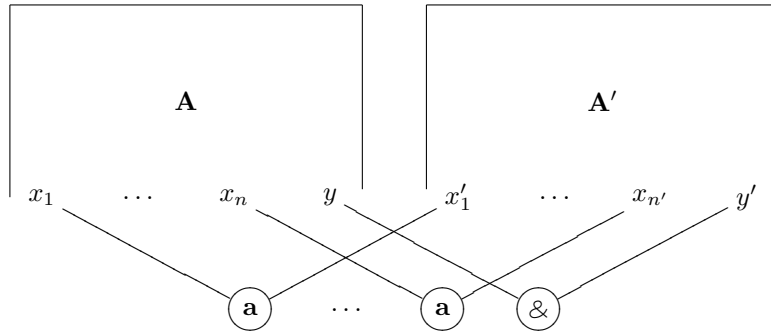

- If the $+_{\text{left}}$ -rule is applied on S to X_1 , yielding $X + X_1$, the resulting net is obtained by adding a $+_l$ -link under x_1 ; the same goes if it is the $+_{\text{right}}$ -rule: just change $+_l$ for a $+_r$.

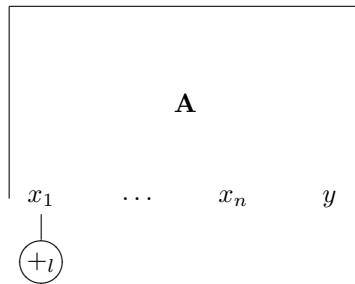

- If the dereliction rule is applied on S to X_1 , the resulting net is obtained by adding a $?$ -link under x_1 .

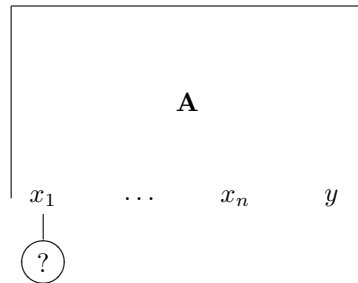

- If the weakening rule is applied on S , adding the formula $?X$, the resulting net is obtained by adding a ι -link x as a new root/leaf to \mathbf{A} , such that $\xi(x) = y$.

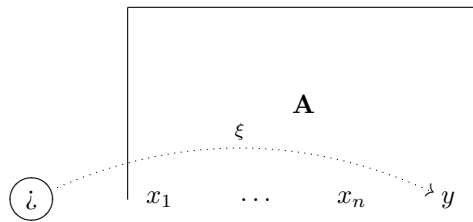

- If formulas X_1, X_2 are contracted in S (both X_1, X_2 being $?X$), the resulting net is obtained by adding a \mathbf{c} -link under x_1, x_2 .

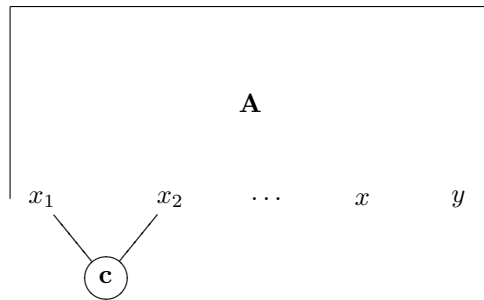

- If the $!$ -rule is applied to S , the resulting net is obtained by adding a \jmath -link under each x_i and a $!-\!$ pair of links under y . The idea of delimiting a $!$ -box

with a row of unary links can also be seen in [13].

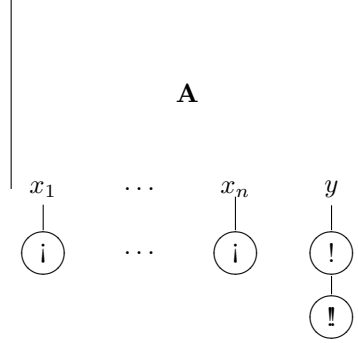

- If the cut rule is applied on S, S' to Y, X'_1 (in particular $X'_1 = Y^\perp$), yielding the sequent $\vdash X_1, \dots, X_n, X'_2, \dots, X'_{n'}, Y' [\Delta, \Delta', Y \text{ct} X'_1]$ then the resulting net is (as for \otimes^\bullet) the disjoint sum of \mathbf{A}, \mathbf{A}' , with a ct-link under Y, X'_1 .

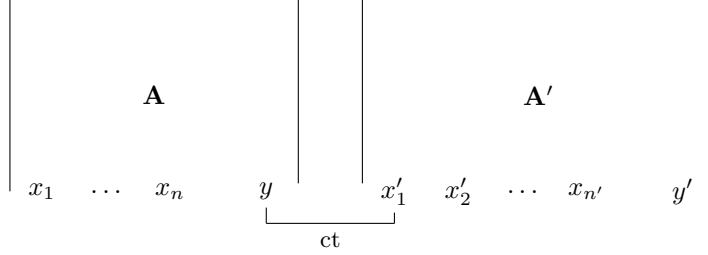

We are interested in characterizing the nets \mathbf{A} over a sequent S that have been obtained from a proof of S in the manner above.

Remark on Notation. In what follows S is a net over sequent \mathbf{A} , and the same notational conventions for them are very much as above. The letter y denotes the unique root link of S of polarity $^\circ$. Letters with subscripts like x_i, x'_i, z_i, z'_i denote root links of \mathbf{A} of polarity $^\bullet$, the use of z s being reserved for ct-links while x is used for other links $^\bullet$. Unsubscripted letters like x, x', z, z^1 are reserved for arbitrary links of \mathbf{A} .

We define the set of *paths* of \mathbf{A} to be the smallest set $\text{Path}(\mathbf{A}) \subset \mathbf{A}^*$ of nonempty words closed under the conditions below (here \cdot is concatenation, the letters u, v denote paths while z, z' denote generic links, seen as words of length one:)

Root $y \in \text{Path}(\mathbf{A})$.

Up If $u \cdot z \in \text{Path}(\mathbf{A})$ and z'° is such that $\text{pr}(z') = z$ then $u \cdot z \cdot z' \in \text{Path}(\mathbf{A})$.

Down If $u \cdot z^\bullet \in \text{Path}(\mathbf{A})$ and $z'^\bullet = \text{pr}(z)$ is defined then $u \cdot z \cdot z' \in \text{Path}(\mathbf{A})$.

DnTurn If $u \cdot z \in \text{Path}(\mathbf{A})$ and $\xi(z') = z$ then $u \cdot z \cdot z' \in \text{Path}(\mathbf{A})$ (obviously z°, z'^\bullet).

There is already a long tradition of using paths in the lambda-calculus, starting with the work of Lévy [12]; there has been a renewal of interest recently due to the connection with parallel reduction and the geometry of interaction [5,6]; for an overview see [1]. Our notion of path is quite similar to the ones that have been proposed before, but not identical to any.

A path u has a unique decomposition $u = v_1^\circ \cdot v_2^\bullet \cdot \dots \cdot v_N$ into a polarity-alternating sequence of words of homogeneous polarity; the v_j° are *ascending* sequences of links in the net, while the v_j^\bullet are *descending* ones. If z is the last link in v_j and z' the first one in v_{j+1} then a z° -to- z'^\bullet transition only happens with $\xi(z') = z$, while a z^\bullet -to- z'° transition will happen at a \otimes^\bullet -link, with z above an occurrence of the form $Z'^\circ \otimes Z^\bullet$, and z' above Z' , or at a ct-link, z above $Z'^\circ \text{ct} Z$ and z' above Z' . It also should be clear that a maximal path ends either with an x_i , or a link which is above an occurrence W that appears in $W^\bullet \wp^\circ W'$.

Proposition 5. *In a path, a $!$ is always immediately preceded by a $\!$ and a nonterminal $\!$ is always immediately followed by a $!$.*

The proof is trivial. \square

Proposition 6. *If \mathbf{A} is obtained from a proof then the following are true.*

finiteness *The set $\text{Path}(\mathbf{A})$ is finite.*

connectedness *Every link of \mathbf{A} can be reached by a path.*

balance *In a path $u = a_1 \cdot a_2 \cdot \dots \cdot a_N$, $a_j \in \mathbf{A}$ the (possibly empty) sequence $B = b_1, b_2, \dots, b_M$ obtained by keeping only the $!$ - and $\!;$ -links of u in order is always a prefix of a correct (well-matched, or balanced) bracketing, with $!$ as left bracket, and $\!;$ as right one. In other word every $\!;$ has a matching $!$ before it, but a $!$ may not have its matching $\!;$ after it. Moreover, the matching $!$ -link to a given $\!;$ is invariant of the path. In other words if $B' = b'_1, b'_2, \dots$ is another sequence obtained the same way as B , such that the same $\!;$ -link z appears in both B, B' , then its matching $!$ -link is the same link in both B, B' .*

The proof is an easy induction and will be left to the reader. \square

We say that a net that satisfies the conditions above is *well-balanced*⁵. Notice that condition **finiteness** ensures that no path loops on itself; also notice that the **balance** property allows the definition of a partial endofunction χ on \mathbf{A} , whose domain of definition is the set of $\!;$ -links and whose value on such a link is the uniquely defined matching $!$ -link. The meaning of **balance** is that given a $!$ introduction in a proof we can recover the box associated with it by looking only at the essential net associated to that proof. One reason for putting a $\!;$ -link under the $!$ when introducing it is that without this additional link **balance** would not be conserved when weakening is applied immediately after a $!$ -introduction.

⁵ This terminology has already been used in a very similar context [1], for very similar reasons.

Let $u \cdot z \cdot z' \in \text{Path}(\mathbf{A})$. An important fact is that the polarity of z' determines “the direction z is coming from”, in the following sense. If z'^{\bullet} then to find z one should first look immediately above z' : z is a successor of z' of polarity \bullet if z' has any; in the case this search is unsuccessful z' is a leaf (see table 2) and z is forced to “come from the side,” i.e. $z = \xi(z')$. On the other hand, if z'° then z only comes from below, that is, $z = \text{pr}(z')$.

We want to allow paths to start on other links than y . Given $x, z \in \mathbf{A}$, we write $v: x \rightarrow z$ whenever $v \in \mathbf{A}^*$ is such that its first link is x and its last one z . We say that such a $v: x \rightarrow z$ is a *path* when there is $u \in \text{Path}(\mathbf{A})$ such that v is a suffix of u ; in other words (because of **connectedness**) when we can go from any link in v to the one immediately after it by following the last three defining conditions for paths. For example, we have $z: z \rightarrow z$ for any $z \in \mathbf{A}$ and $u: y \rightarrow z$ iff $u \in \text{Path}(\mathbf{A})$ and its last link is z .

A well-balanced net does not necessarily come from a proof; in order to characterize those that do we need another kind of “path” in the set of links. We define the set of *trails* $\text{Trail}(\mathbf{A}) \subseteq \mathbf{A}^*$ of \mathbf{A} to be the smallest set of nonempty words $u \in \mathbf{A}^*$ closed under the conditions **Root**, **Up**, **DnTurn**, but where condition **Down** is replaced by

Down' If $u \cdot z^{\bullet} \in \text{Trail}(\mathbf{A})$, $z'^{\bullet} = \text{pr}(z)$ and neither z, z' is a \downarrow -link then $u \cdot z \cdot z' \in \text{Trail}(\mathbf{A})$.

Box1 In $u \cdot z \in \text{Trail}(\mathbf{A})$, if z is a \downarrow -link and $\chi(z') = z$ then $u \cdot z \cdot z' \in \text{Trail}(\mathbf{A})$.

Box2 If z is a \downarrow -link and z' has a \downarrow -link z'' for successor such that $\text{pr}(\chi(z'')) = z$ then $u \cdot z' \in \text{Trail}(\mathbf{A})$.

Notice that if \mathbf{A} is an additive-multiplicative net the sets $\text{Path}(\mathbf{A})$ and $\text{Trail}(\mathbf{A})$ coincide. The set $\text{Trail}(\mathbf{A})$, ordered by prefix, is obviously a tree, whose root is y . It is easy to see $\text{Trail}(\mathbf{A})$ obeys conditions **finiteness**, **connectedness** but that **balance** has become trivial: if a \downarrow appears in a trail, only one appears, is at the end, and is preceded by one or more \downarrow s. It should be clear what we mean by “a trail $v: x \rightarrow z$ ”: it is a word starting in x and ending in z which is a suffix of an element of $\text{Trail}(\mathbf{A})$.

The following diagram illustrates how trails differ from paths (we start with the path $\dots \downarrow \downarrow \dots z \cdot \downarrow \cdot x \dots$ where the \downarrow and \downarrow are matched; in the vertical columns in the diagram below everything is the predecessor of what is immediately above. We draw our paths from left to right because in a sequent the formula^o is always

to the right of the formulas[•].)

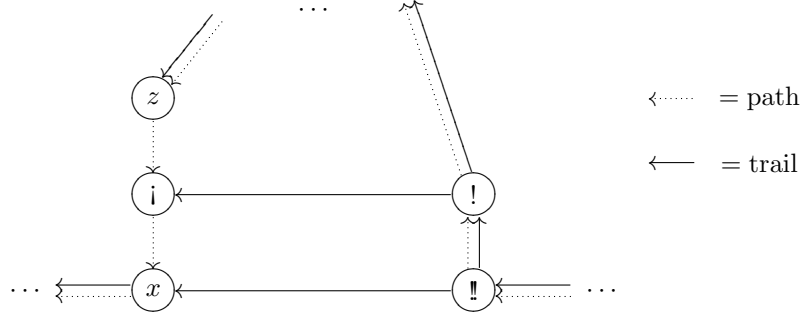

Let us say a little on how to go from paths to trails and vice versa. First it should be obvious that trails are obtained from paths by *removing* links, while paths are obtained from trails by *adding* links. Both these procedures are far from giving unique results in general, but can always be carried out. The diagram above should give a good idea, given a path, of the different pruning ways that are available whenever a $!-!$ pair is met: for every such pair one of three subwords can be chosen to be kept. Naturally the formal definition of this nondeterministic pruning procedure is recursive, since to obtain a trail a choice has to be made for every matching $!-!$ pair in the given path. Notice that in the diagram above a trail that ends in z or j is maximal.

In a trail a $!$ -link x is always followed by its pr-successor or by z such that $\chi(z) = x$ (remember that in the definition of a net we forbid the image of ξ from containing $!$ -links). We call a two-link trail $x \cdot z: x \rightarrow z$ such that $\chi(z) = x$ a *shell of the first kind*. A $!!$ -link x is followed by its pr-successor, by a z such that $\xi(z) = x$, or by a z that has a successor z' with $\text{pr}(\chi(z')) = x$. In the last case we call such a two-link trail $x \cdot z$ a *shell of the second kind*.

Given a trail u , let us show to obtain a path from it. This is done by stuffing all the shells $x \cdot z$ that appear as subwords in u . If $x \cdot z$ is a shell of the first kind, we just have to find a path $v: x \rightarrow z$ (this can always be done, obviously) and replace $x \cdot z$ in u by v . If $x \cdot z$ is a shell of the second kind, let the $!$ -link x' be the successor to x and z' be a j -link which is a successor to z ; find a path $v: x' \rightarrow z'$ and insert v between x and z , in other words replace $x \cdot z$ by $x \cdot v \cdot z$.

There is a most important order structure on \mathbf{A} which is derived from the trail structure.

Definition 3. Given $x, z \in \mathbf{A}$ we write $x \trianglelefteq z$ if x appears in every trail $u: y \rightarrow z$.

It is trivial to show \trianglelefteq is transitive, and just as easy (using the absence of loops) to show antireflexivity; therefore $(\mathbf{A}, \trianglelefteq)$ is a poset, and obviously it has y for least element.

Proposition 7. Given $x, x' \trianglelefteq z$ we either have $x \trianglelefteq x'$ or $x' \trianglelefteq x$; thus \trianglelefteq is a tree structure on \mathbf{A} , with y as the root.

Choose a trail $u: y \rightarrow z$. We know x, x' have to appear exactly once in u (because there are no loops); without loss of generality assume x' appears after x , and let u decompose as $u = v \cdot v'$ where $v: y \rightarrow x'$ and $v': x' \rightarrow z$. We claim $x \trianglelefteq x'$; this is because given any trail $w: y \rightarrow x'$ the trail $w \cdot v': y \rightarrow z$ has to contain x since $x \trianglelefteq z$; it is easy to see that x is in w instead of v' (thus proving our claim) because otherwise a loop could be obtained by a simple use of cut-and-paste. \square

A consequence of this is that the \trianglelefteq ordering has infs; we will denote the meet of x, z by $x \Delta z$. We also write $x \triangleleft z$ when $x \trianglelefteq z, x \neq z$. The ordering \trianglelefteq is a *dependence* (or *causality*) relation between links: if $x \trianglelefteq z$, z depends on x ; it can be reached only through x . In particular, if x is duplicated in a cut elimination because of an additive contraction, or erased (because of a $+_l$ or $+_r$) it will turn out that z is too.

Definition 4. Given $z^\circ \in \mathbf{A}$ we define its empire to be:

$$\text{em}(z) = \{x \in \mathbf{A} \mid x \triangleright z\}$$

and the border of its empire to be:

$$\text{bem}(z) = \left\{ x^\bullet \in \text{em}(z) \mid \begin{array}{l} x \text{ is an active root} \\ \text{or } \text{pr}(x) \text{ is defined and not in } \text{em}(z) \end{array} \right\}$$

Our definition of the empire of a link works only when this link has polarity \circ . But it coincides with the original one [4] (and all the other standard ones, say [2] whenever this makes sense; for example, if \mathbf{A} is an essential net all whose links are multiplicative, and if z° , one can associate to \mathbf{A} an ordinary multiplicative net \mathbf{A}' by simply forgetting all the polarities of the links of \mathbf{A} . Then $\text{em}(z)$ will be the same for both definitions of empire, ours on \mathbf{A} and the traditional one on \mathbf{A}' . The same goes if \mathbf{A} has both multiplicatives and additive links (this includes additive contractions).

We can now explain why we use trails instead of paths in the definition of \trianglelefteq . The reason is that the empire of a z° inside a !-box should never go beyond that box; indeed this is the very justification for introducing the definition of trail. Notice that trails only make sense in well-balanced nets, and paths are necessary to define well-balancedness.

Proposition 8. Let $x^\bullet, \text{pr}(x)^\bullet$ and neither be a !-link. Let $z \triangleleft \text{pr}(x)$. Then $z \trianglelefteq x$.

Let $u: y \rightarrow x$ be a trail. Since $u \cdot \text{pr}(x)$ is also a trail it contains z , and then u contains z obviously. \square

Proposition 9. If $z^\circ \neq y$ its \trianglelefteq -predecessor is its \leq -predecessor $\text{pr}(z)$.

We have already remarked that in a path $u \cdot z' \cdot z^\circ$ the link z' always has to be $\text{pr}(z)$ and this is the same for trails because the definition does not differ when z° . \square

Here is another illustration of why a $!-!$ pair is used instead of a single link: in the net below the \wp^\bullet -link is in the empire of the $!-!$ -link but not of the $!$ -link. But this is the way it should be because if the $!-!$ -link is cut against an \mathbf{a} -link the \wp^\bullet should be duplicated, while if it is cut against a \mathbf{c} -link the \wp^\bullet should not (because of the typing rules, the \mathbf{c} -links that have to be introduced have to be immediately below the \wp s); in both cases the \wp -links in the empire of the $!$ are duplicated.

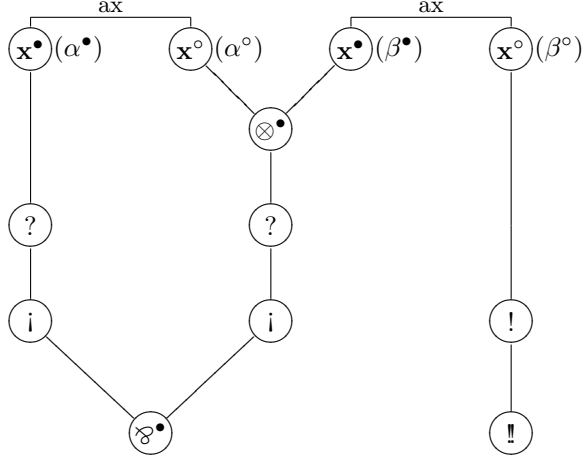

Definition 5. We say a net \mathbf{A} over sequent Γ is correct if it is well-balanced and in addition the following conditions hold:

1. Given x link above Z^\bullet such that $Z\wp^\circ Z'$ is an occurrence, then if $x' \leq x$ is the unique \wp° -link above $Z\wp^\circ Z'$ (Proposition 3,2) we have $x' \trianglelefteq x$.
2. If x is a $!$ -link and $z \in \text{bem}(x)$ then z is a \wp -link.
3. Let $x \neq x'$ be distinct links that are above the same occurrence. If $x \Delta x'$ is a $\&$ -link then $x \wedge x'$ is an \mathbf{a} -link; otherwise $x \wedge x'$ is a \mathbf{c} -link.
4. Let $w \in \mathbf{A}$ be a $\&$ -link, above the occurrence $W_1 \& W_2$, and w_1, w_2 the two successors of w , w_k above W_k . Then if $x \in \text{bem}(w_k)$ for either $k = 1$ or 2 , there exists $x' \in \text{bem}(w_{k'})$, $k' \neq k$ above the same occurrence as x .

Theorem 1 (Sequentialization). A net \mathbf{A} over sequent S comes from a proof of S iff it is correct.

From now on \mathbf{A} is assumed to be a correct essential net.

The crux of the proof is a variation on the \trianglelefteq -predecessor: define the endo-function \mathcal{P}_\circ on \mathbf{A} as

$$\mathcal{P}_\circ(x) = \begin{cases} \text{the greatest } z^\circ \text{ with } z \triangleleft x \text{ if } x \neq y \\ y \text{ if } x = y \end{cases}$$

Proposition 10. If $z^\circ \in \mathbf{A}$ and $x \neq z$ then $x \in \text{em}(z)$ iff $\mathcal{P}_\circ(x) \triangleright z$.

The proof is obvious. \square

Notice that when x is a \mathbf{x}^\bullet or a i then $\mathcal{P}_\circ(x) = \xi(x)$, and thus \mathcal{P}_\circ can be thought of as an extension of ξ .

The crucial property of \mathcal{P}_\circ is the following:

Lemma 1. *If $x \in \mathbf{A}$ is such that $x' = \text{pr}(x)$ is defined then $\mathcal{P}_\circ(x') \sqsubseteq \mathcal{P}_\circ(x)$.*

This is proved by cases, some of which are interesting by themselves.

1. The first case we tackle is if both x^\bullet, x'^\bullet , and neither is a j -link. Then the result follows from Proposition 8: If z is the \sqsubseteq -predecessor of x' we have $\mathcal{P}_\circ(x') \sqsubseteq z \sqsubseteq x$ and thus $\mathcal{P}_\circ(x') \sqsubseteq \mathcal{P}_\circ(x)$ by the defining property of $\mathcal{P}_\circ(x)$ (we know $\mathcal{P}_\circ(x')^\circ!$).
2. In the special subcase that x^\bullet, x'^\bullet and x is the unique successor of x' it is easy to see that $\mathcal{P}_\circ(x') = \mathcal{P}_\circ(x)$ because any trail ending in x' has the form $v \cdot x \cdot x'$.
3. If x°, x'^\bullet then we know x' is a \otimes^\bullet -link or a ct -link (in case the reader hasn't noticed yet, they are the only links for which this combination of polarities happens). By Proposition 9 we get that the \sqsubseteq -predecessor of x is x' and we get $\mathcal{P}_\circ(x) = \mathcal{P}_\circ(x')$ since x'^\bullet .
4. If x' is a j -link its unique successor is x ; it is clear that $\mathcal{P}_\circ(x') = \chi(x')$ (use the same kind of argument as Point 2 above). Let $u: y \rightarrow x$ be a trail; extend it to a path v . In more details, enumerating every shell (of either kind) in u by $a_k \cdot b_k$, $1 \leq k \leq N$, a path $a_k \cdot w_k \cdot b_k: a_k \rightarrow b_k$ has been chosen and v is the result of replacing every shell $a_k \cdot b_k$ in u by $a_k \cdot w_k \cdot b_k$. We know $v \cdot x'$ is a path too, and thus can be extended to a maximal path. Hence the j -link x' has its matching $!$ -link $\chi(x')$ in v . But $\chi(x')$ was in u already because the w_k are well-bracketed paths: if $a_k \cdot b_k$ is a shell of the first kind a_k and b_k are a matching $!j$ pair while if $a_k \cdot b_k$ is a shell of the second kind w_k begins and ends with a matching $!j$ pair. Therefore it is impossible for $\chi(x')$ to fall inside a w_k . We have shown that $\mathcal{P}_\circ(x') = \chi(x')$ is in every trail to x , hence the result: $\mathcal{P}_\circ(x') \sqsubseteq \mathcal{P}_\circ(x)$.
5. If x is a j -link then it is easy to see that $\mathcal{P}_\circ(x') = \text{pr}(\chi(x))$ and the result follows by using the case below.
6. If both x°, x'° then we have $\mathcal{P}_\circ(x) = x'$ (by 9) and the result follows immediately.
7. If x^\bullet, x'° then we know x' is a \wp° -link and by correctness property 1 we have $x' \sqsubseteq x$ and the result follows immediately.

This has an easy corollary:

Proposition 11. *Let $z^\circ \in \mathbf{A}$, $x \in \text{em}(z)$ and $x' \geq x$. Then $x' \in \text{em}(z)$.*

Either $x' \neq z$ and we repeatedly apply Proposition 1 along with Proposition 10 or $x' = z$ and the conclusion is trivial. \square

In other words: given z° , the \sqsubseteq -up-set above z is also a \leq -up-set. This gives rise to the following:

Definition 6. Let $z^\circ \in \mathbf{A}$. We define the sequent associated to z to be the sequent

$$S_z = \vdash \Theta [\Phi]$$

where Θ is the strong multiset $\{\text{Type}(x) \mid x \in \text{bem}(z)\} + \{\text{Type}(z)\}$ and $\Phi \subseteq \Delta$ the multiset of ct-formulas Z_j such that $z_j \in \text{em}(z)$.

Here we use set-theoretical notation for *strong multisets*; e.g. if two distinct elements $x, x' \in \text{bem}(z)$ are above the same occurrence of a subformula X then X will appear at least twice in Θ .

Proposition 12. Given z°, S_z as above the formulas of S_z are in bijective correspondence with the \leq -minimal elements of the set $\text{em}(z) \subseteq \mathbf{A}$.

Let x° be minimal in $\text{em}(z)$ and such that $\text{pr}(x)$ is defined. We claim $x = z$; to show this assume the opposite for a contradiction. Then $\mathcal{P}_\circ(x) \in \text{em}(z)$ by 10; either $\text{pr}(x)^\bullet$ or $\text{pr}(x)^\circ$. In the first case we have $\mathcal{P}_\circ(\text{pr}(x)) = \mathcal{P}_\circ(x)$ by Proposition 1,3 and this contradicts the assumption that $\text{pr}(x) \notin \text{em}(z)$. In the second case we have $\mathcal{P}_\circ(x) = \text{pr}(x)$ by Proposition 1,6 and this also contradicts the assumption that $\text{pr}(x) \notin \text{em}(z)$. Thus if x° is minimal in $\text{em}(z)$ it is z . Otherwise x^\bullet and it is either in $\text{bem}(z)$ or not, and if not it has to be (recall the definition of empire) an inactive root, one of the z_j that are in $\text{em}(z)$. \square

Thus we can turn $\text{em}(z)$ into a forest of links over S_z , by simply taking the forest structure induced from pr (remember, $\text{em}(z)$ is \leq -up-closed by Proposition 11) and it is easy to construct a projection $\rho_z: \text{em}(z) \rightarrow \mathbf{O}(S_z)$. The endofunction ξ restricts to $\text{em}(z)$ because $\mathcal{P}_\circ(x) = \xi(x)$ when x^\bullet is a leaf. We have shown $\text{em}(z)$ is an essential net over S_z .

Lemma 2. If $z^\circ \in \mathbf{A}$ and is not a !-link then $\text{em}(z) \subset \mathbf{A}$ is a correct net over its associated sequent S_z . If z is a !-link then $\text{em}(z) \cup \{\text{pr}(z)\}$ is a correct net over S_z .

Most of the hard work has already been done. . \square

Proposition 13. Let z° and $x \in \text{bem}(z)$. Then if $\text{pr}(x)$ exists we have $\mathcal{P}_\circ(\text{pr}(x)) \triangleleft z$.

This is because the set $x \downarrow = \{a \mid a \trianglelefteq x\}$ is totally ordered, and contains both $\mathcal{P}_\circ(\text{pr}(x))$ (by 10) and z , but the case $\text{pr}(x) \triangleright z$ is obviously impossible. \square

We need some facts about $\&$ -links and the shape of their empires.

Proposition 14. Let $x \in \mathbf{A}$ be an \mathbf{a} -link and x^1, x^2 its two successors. Then $\mathcal{P}_\circ(x) = x^1 \triangle x^2$ and is a $\&$ -link. Furthermore, we have that $\mathcal{P}_\circ(x^1)$, $\mathcal{P}_\circ(x^2)$ and $\mathcal{P}_\circ(x)$ are all distinct.

Since x^1 and x^2 (and x) are above the same occurrence $x^1 \Delta x^2$ has to be a $\&$ -link otherwise $x^1 \wedge x^2 = x$ would be a \mathbf{c} -link by correctness property 3. If z is the \leq -predecessor of x we know (Proposition 1,1) $z \leq x^1, x^2$ and thus $z \leq x^1 \Delta x^2$; but any trail to x has to go via either x^1 or x^2 and so has to contain $x^1 \& x^2$, hence $x^1 \& x^2 \leq z$, and since $(x^1 \Delta x^2)^\circ$ we get that $\mathcal{P}_\circ(x) = z = x^1 \Delta x^2$ and this proves our first claim. Now a trail $u: y \rightarrow x^k$ has not only to contain the $\&$ -link $x^1 \Delta x^2$ but also one of its successors. This is because if we write u as $y \dots (x^1 \Delta x^2) \cdot a \dots x$ then if a is not a successor to $x^1 \Delta x^2$ we have to have a^\bullet and $\xi(a) = x^1 \Delta x^2$, and the definition of a net explicitly forbids $\xi(a^\bullet)$ to be a $\&$ -link. Thus $x^1 \neq x^1 \Delta x^2 \neq x^2$, and we can number the successors of $x^1 \Delta x^2$ as w^1, w^2 in such a way that $w^k \leq x^k$ and then $w^k \leq \mathcal{P}_\circ(x^k)$ since w^{k° , and this more than proves the second claim. \square

The following result looks like a strengthening of correctness property 4; the reader is invited to compare it with that property.

Proposition 15. *If $w \in \mathbf{A}$ is a $\&$ -link above $W_1 \& W_2$ and w_1, w_2 the two successors of w , w_k above W_k , and if $a \in \text{bem}(w_k)$ for $k = 1$ or 2 then $\text{pr}(a)$ is an \mathbf{a} -link whose other successor is a link $a' \in \text{bem}(w_{k'})$, $k' \neq k$, giving a bijective correspondence with the sets $\text{bem}(w_1), \text{bem}(w_2)$.*

Before we get on with the proof, notice that this says that the empire of a $\&$ -link always has a \leq -lower closed set of the following form (a picture is worth a thousand words; here we have enumerated the set $\text{bem}(w_k)$ as $a_1^k, a_2^k, \dots, a_N^k$, and the \mathbf{a} -links accordingly):

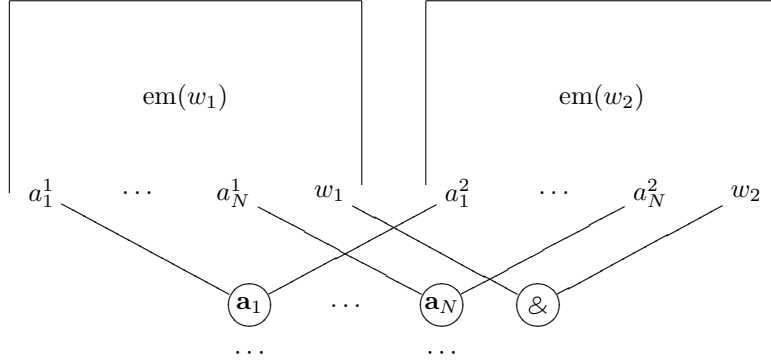

Now for the proof: without loss of generality we can decree $a \in \text{bem}(w_1)$; we know by correctness property 4 that there is $a' \in \text{bem}(w_2)$ above the same occurrence as a and since $a \Delta a' = w$ obviously we get that $a \leq a'$ is a $\&$ -link, and then $z = a \wedge a'$ is an \mathbf{a} -link by correctness property 3 and $\mathcal{P}_\circ(a) = w$ by the previous proposition. So all we have to do is show that there is nothing between z, a and z, a' . Let $x \leq a, x' \leq a'$ be the successors of z and assume for a contradiction that $x \neq a$. Since $a \in \text{bem}(w_1)$ we have $\mathcal{P}_\circ(x) \triangleleft w_1$ by 13. Since $\text{pr}(x) = z$ and $\mathcal{P}_\circ(z) = w$ another application of 1 gives us $\mathcal{P}_\circ(x) = \mathcal{P}_\circ(z) = w$. But this contradicts the second clause of the previous proposition. This argument works for x', a' too. \square

We also need this

Proposition 16. *Let $x^\bullet \in \mathbf{A}$ be such that $\mathcal{P}_\circ(x) = y$. Then if it exists $\text{pr}(x)^\bullet$ and $\mathcal{P}_\circ(\text{pr}(x)) = y$.*

We already know that $\mathcal{P}_\circ(\text{pr}(x)) = y$ by 1; assume $\text{pr}(x)^\circ$ for a contradiction. This forces $\text{pr}(x)$ to be a \wp° -link, and by correctness property 1 we have $\text{pr}(x) \triangleleft x$. But this is impossible, since $\text{pr}(x)$ has a \triangleleft -successor z° (its other pr-successor) and thus there now are two \circ links \triangleleft -below x , $\text{pr}(x)$ and z , which clearly contradicts the assumption $\mathcal{P}_\circ(x) = y$. \square

We can now start proving Theorem 1 explicitly. Necessity is proved by induction, as should be expected: it suffices to show that the proof rules always produce correct nets; there is nothing particularly surprising or difficult with this part of the proof, and it will be omitted here. For sufficiency, as before assuming that \mathbf{A} is a correct net above S , the idea is of course to try to decompose \mathbf{A} in smaller correct subnets, while showing that \mathbf{A} can be obtained from these subnets by the proof rules. This decomposition is always articulated around root links, but the different root links in the net have different priorities. In other words it will be seen that one can always find a root link that will allow a reduction of the net, and that there is a well-defined search order among the root links. The links that one looks at first are the active roots x_i such that $\mathcal{P}_\circ(x_i) = y$, and such that x_i is one of the following: \wp^\bullet , $+_l$, $+_r$, i , $?$, \mathbf{c} .

- If x_i is a \wp^\bullet -link, writing $X_i = Z^\bullet \wp Z'^\bullet$, by removing x_i from \mathbf{A} we get a net above the sequent $\vdash X_1, \dots, X_{i-1}, Z, Z', X_{i+1}, \dots, Y [\Delta]$. It is quite easy to show this new net is a correct net, since the link that's been removed was “at the outer edge”, i.e. terminal in both the set of paths and the set of trails, and so its removal did not disturb anything but itself. Obviously \mathbf{A} can be obtained from this new net by a \wp^\bullet -rule.
- If x_i is a $+_l$ -link, if we write $X_i = Z + Z'$ then by removing x_i from \mathbf{A} we get a net above the sequent $\vdash X_1, \dots, X_{i-1}, Z', X_{i+1}, \dots, Y [\Delta]$ and it is a correct net for the same reason as above. Obviously \mathbf{A} can be obtained from this new net by introducing a $+$ to the left.
- The same goes if x_i is a $+_r$ -link, but removing x_i this times yields a correct sequent above $\vdash X_1, \dots, X_{i-1}, Z, X_{i+1}, \dots, Y [\Delta]$.
- If x_i is a i -link then it should be obvious that removing it yields a correct net over the sequent $\vdash X_1, \dots, X_{i-1}, X_{i+1}, \dots, Y [\Delta]$, and introducing X_i via a weakening will give us \mathbf{A} back, since $\xi(x_i) = y$.
- If x_i is a $?$ -link, with $X_i = ?X$ then removing x_i gives a correct net over the sequent $\vdash X_1, \dots, X_{i-1}, X, X_{i+1}, \dots, Y [\Delta]$, for the usual reasons, and \mathbf{A} can be obtained from this new sequent by applying dereliction on X .
- If x_i is a \mathbf{c} -link, after removing it there will be two \leq -minimal links above X_i : the successors of x_i . Thus the sequent associated to the forest of links $\mathbf{A} - \{x_i\}$ is $\vdash X_1, \dots, X_{i-1}, X_i, X_i, X_{i+1}, \dots, Y [\Delta]$; $\mathbf{A} - \{x_i\}$ is a correct net above this sequent for the usual reasons, and \mathbf{A} is obtained from it by applying the contraction rule.

If none of the cases above apply, there may still be a root x^\bullet such that $\mathcal{P}_\circ(x) = y$, but it can only be one of the following: x is an x_i and one of $\otimes^\bullet, \mathbf{a}, \mathbf{x}^\bullet$, or x is a ct-link z_j . Notice that x can never be a j-link because then $\mathcal{P}_\circ(x) = \chi(x)$ is a !-link, which cannot be y . The cases on which we now concentrate are the \otimes^\bullet -links and the ct-links: let \mathcal{X} be the set

$$\mathcal{X} = \left\{ x \in \mathbf{A} \mid \mathcal{P}_\circ(x) = y \text{ and } \begin{array}{l} x \text{ is an active root } x_i \text{ which is a } \otimes^\bullet\text{-link} \\ \text{or } x \text{ is an inactive root } z_j \end{array} \right\}.$$

To every element of \mathcal{X} one can associate a link of polarity \circ :

$$\text{su}(x) = \text{its unique } \leq\text{-successor of polarity } \circ$$

The essential property of $\text{su}(x)$ is that clearly it is *the unique* \leq -successor of x . From this we get that $\mathcal{P}_\circ(\text{su}(x)) = \mathcal{P}_\circ(x) = y$ always.

Lemma 3. *There is $x \in \mathcal{X}$ such that $\text{bem}(\text{su}(x))$ is either empty or composed uniquely of (necessarily active by definition of bem) root formulas.*

The proof is by contradiction: assume there is no such x . Pick $x^1 \in \mathcal{X}$ at random. By assumption there is $a \in \text{bem}(\text{su}(x^1))$ such that a is not a root of \mathbf{A} . Then $\mathcal{P}_\circ(\text{pr}(a)) \triangleleft x^1$ by 13 and this forces $\mathcal{P}_\circ(\text{pr}(a)) = y$ because $\mathcal{P}_\circ(\text{su}(x^1)) = \mathcal{P}_\circ(x^1) = y$ by the remark just above. Thus by 16 if x^2 is the root \leq -below a we have x^2^\bullet and $\mathcal{P}_\circ(x^2) = y$. If x^2 is an inactive root it is in \mathcal{X} ; we claim this is also the case if x^2 is an *active* root; in other words if x^2 is an active root we claim it is a \otimes^\bullet -link:

- x^2 obviously cannot be an \mathbf{x}^\bullet -link.
- If x^2 is an \mathbf{a} -link let x' be its \leq -successor on the same side as a , i.e. $x' = \leq a$. We know by 15 that $y = \mathcal{P}_\circ(x^2)$ is a $\&$ -link and that $x' \in \text{bem}(w)$, where w is one of the successors of y . This forces $x' = a$ (because otherwise $\mathcal{P}_\circ(x') = y = \mathcal{P}_\circ(x)$ and this is impossible), and then since the set $a \downarrow = \{w \mid w \leq a\}$ is totally ordered we have $x \supseteq w$ (the reverse is clearly absurd) and this is impossible because $\mathcal{P}_\circ(x^1) = y$. Thus x^2 cannot be an \mathbf{a} -link.

We have proved our claim and $x^2 \in \mathcal{X}$. We can play this game again: find a link $a_2 \in \text{bem}(\text{su}(x^2))$ which is not a root and then for the same reasons as above the root $x^3 \leq a_2$ will be an element of \mathcal{X} and thus we can construct an infinite path

$$y \dots x^1 \cdot \text{su}(x^1) \dots x^2 \cdot \text{su}(x^2) \dots$$

and this is a contradiction. \square

Now that we know there is $x \in \mathcal{X}$ such that $\text{bem}(\text{su}(x))$ has only roots in it we can split the proof at that link: assume first that x is a \otimes^\bullet -link x_i and let $X_i = Z^\circ \otimes Z'^\bullet$. If $\vdash \Theta, Z [\Phi]$ is the sequent associated to $\text{su}(x)$ we know that $\Theta \subset \Gamma, \Phi \subset \Delta$ are sub-multisets; it is easy to see that $\mathbf{A} - \text{em}(\text{su}(x)) - \{x_i\}$ is a correct net over the sequent $\vdash \{Z'\} + \Gamma - \Theta - \{X_i\} [\Delta - \Phi]$ (the usual argument:

we have removed from \mathbf{A} a subset which is both \leq - and \leq - up-closed, and also \leq -down-closed; thus the remaining net has not been disturbed). It is then easy to see that \mathbf{A} can be obtained by applying the \otimes^\bullet -rule to these two subnets.

The other case is if x is z_j , letting $Z_j = Z^{\circ\text{ct}}Z'^\bullet$. Things are just as before: again we take $\vdash\Theta, Z[\Phi]$ to be the sequent associated with $\text{su}(x)$, and it is easy to see that $\mathbf{A} - \text{em}(\text{su}(x)) - \{z_j\}$ is a correct net over $\vdash\{Z'\} + \Gamma - \Theta[\Delta - \Phi - \{Z_j\}]$. Thus \mathbf{A} can be obtained by applying the cut rule to these two subnets via Z, Z' .

From now on we can assume that the only root links x^\bullet such that $\mathcal{P}_\circ(x) = y$ are active roots x_i , and they can only be \mathbf{x}^\bullet - and \mathbf{a} -links. We will eliminate the case of x_i an \mathbf{x} -link in the next paragraph. Subsequently we will assume that the only ones left are \mathbf{a} -links.

Suppose there is such an x_i which is an \mathbf{x}^\bullet -link. Therefore $y = \xi(x_i)$ is an \mathbf{x}° -link. We claim that in a path y can only be followed by x_i . The other possibility is that there would be a leaf $z^\bullet \neq x_i$ with $\xi(z) = y$. Letting z' be the root below z we know by Proposition 16 that z'^\bullet and $\mathcal{P}_\circ(z') = y$. z' is obviously not an \mathbf{x}^\bullet -link, and it cannot be an \mathbf{a} -link (y would be a $\&$ -link). Thus the only successor to y in a path is x_i , and x_i has no successor at all, being both a root and a leaf. We have shown that the sequent S is in fact an axiom sequent $\vdash Y^\perp, Y$.

We can now start looking at y , which cannot be an axiom link.

- If y is a $\&$ -link, let w_1, w_2 be its two successors. We know (Proposition 15) that the sets $\text{bem}(w_1), \text{bem}(w_2)$ are in a bijective correspondence mediated by a row of \mathbf{a} -links. Choose $k = 1$ or 2 and let x be an \mathbf{a} -link immediately below $\text{bem}(w_k)$ (if $\text{bem}(w_k)$ is nonempty!). We know $\mathcal{P}_\circ(x) = y$, and we claim x is a root link. Assume for a contradiction there is a root link $x' < x$. We know $x'^\bullet, \mathcal{P}_\circ(x') = y$ by Proposition 16, and thus x' is an \mathbf{a} -link. But this is impossible, for if $x'' \leq x$ were a successor to x' we would have $\mathcal{P}_\circ(x'') = \mathcal{P}_\circ(x') = y$ and this contradicts Proposition 14. But this shows that \mathbf{A} has been obtained by applying the $\&$ -rule to $\text{em}(w_1), \text{em}(w_2)$, since the net cannot contain anything else: any path or trail that ends in a root has to end with an \mathbf{a} -link.

We have (finally!) reached the point where the equation $y = \mathcal{P}_\circ(x^\bullet)$ has no solution: if a solution exists there is a root solution by 16 and all root solutions have now been eliminated (\mathbf{a} -link roots in the paragraph above.)

- If y is a \otimes° -link, let y_1, y_2 be its two successors, and let y_k be above the subformula Y_k . If $x \in \text{bem}(y_k)$ for $k = 1$ or 2 then x has to be a root. Otherwise its predecessor x' would be such that $\mathcal{P}_\circ(x') \triangleleft y_k$ by Proposition 13. But then $\mathcal{P}_\circ(x') = y$ Proposition 1,6 and this contradicts the assertion made immediately above. Thus we get a partition $\Gamma = \Theta_1 + \Theta_2$ by taking $\Theta_k = \{X_i \mid x_i \in \text{em}(y_k)\}$ and another partition $\Delta = \Phi_1 + \Phi_2$ by taking $\Phi_k = \{Z_j \mid z_j \in \text{em}(y_k)\}$. It is then easy to see that \mathbf{A} can be obtained by applying the \otimes° -rule to the sequents $\vdash\Theta_k, Y_k[\Phi_k], k = 1, 2$.
- If y is a \wp° -link, let y_1, y_2 be its two successors and let y_k be above the subformula Y_k , with Y_1^\bullet, Y_2° . The net $\mathbf{A} - \{y\}$ is correct over the sequent

$\Gamma, Y_1, Y_2 [\Delta]$; this is because \mathbf{A} is the “lifting” of the smaller sequent, since there is no x^\bullet with $\mathcal{P}_\circ(x) = y$ and thus y_2 is the \leq -root of the smaller sequent. Hence \mathbf{A} can be obtained by applying the \wp° -rule to $\mathbf{A} - \{y\}$.

- If y is a $!$ -link, we have $Y = !(Y')$ for a subformula Y' , and we let the $!$ -link y' be y 's successor. We claim that every $x \in \text{bem}(y')$ is a root x_i . Otherwise $\mathcal{P}_\circ(\text{pr}(x)) \triangleleft y'$ by Proposition 13 and this forces $\mathcal{P}_\circ(x) = y$, a contradiction. We get that $\text{em}(y') + \{y\} = \text{em}(y) = \mathbf{A}$ and that every x_i is a j -link that matches y' (it is easy to see that if $\mathcal{P}_\circ(x) = y'$ then x has to be such a j -link). We have shown that if y'' above Y' is the successor of y' then \mathbf{A} can be obtained from the obviously correct net

$$\text{em}(y'') = \mathbf{A} - \{x_i \mid i \leq n\} - \{y, y'\}$$

over the sequent $\vdash X_1, \dots, X_n, Y'$ by applying the $!$ -rule.

This concludes the proof of the theorem.

3 Evaluation of essential nets

In this section we give a cut-elimination procedure for essential nets that obviously cannot be thought of as parallel but which is a step towards executable nets. The reader will notice that it is very similar to what is given in [4]. As usual \mathbf{A} is a correct net over the sequent $\vdash X_1^\bullet, \dots, X_n^\bullet, Y^\circ [Z_1, \dots, Z_m]$ and we use the convention of naming a root link after the formula it's above.

Choose a cut link in z_j in \mathbf{A} ; let (z°, z'^\bullet) be the two successors of z_j ; in this section we tend to designate a cut link by its pair of successors.

The first case we consider is if z is an \mathbf{x}° -link. Thus there is a unique \mathbf{x}^\bullet -link x such that $\xi(x) = z$. Then we can construct a new net by getting rid of x and letting $\text{pr}(z') = \text{pr}(x)$ (if we call this link x' , it is not always the case that it is defined, but we can nonetheless use the variable x' as a place marker). We are not finished yet: there may be other links a such that $\xi(a) = z$. We then have to redefine $\xi(a) = \mathcal{P}_\circ(z')$.

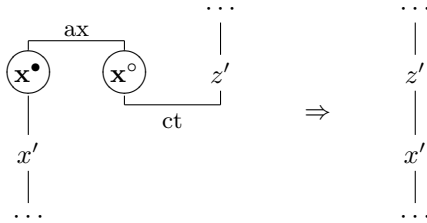

There is a symmetrical case, when z' is an \mathbf{x}° -link. This time x' denotes $\text{pr}(\xi(z'))$.

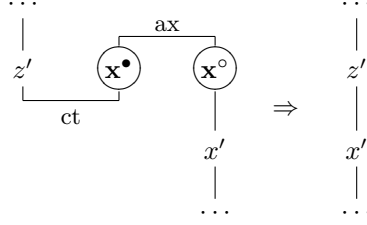

Here, for every leaf $a \neq z'$ such that $\xi(a) = \xi(z')$ we have to redefine $\xi(a) = z$ since $\xi(z')$ disappears.

In all the cases that follow z' will disappear during the reduction step. It is not the case that z will always disappear (for instance it may be duplicated). But in the list of cases below, in every instance where z is eliminated we have to redefine $\xi(a)$ whenever $\xi(a) = z$ and the new value will always be $\mathcal{P}_0(z')$.

If z' is a \mathcal{P}^\bullet -link, the proposition above tells us that z is a \otimes° -link. Then the reduction step goes just as in the classical theory for the multiplicative fragment, except that we have to redefine $\xi(a)$ for links a^\bullet such that $\xi(a) = z$, as has just been said.

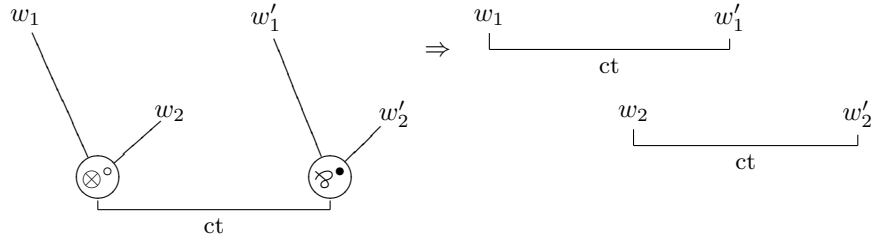

The same thing happens, mutatis mutandis, if z' is a \otimes^\bullet -link.

If z' is an \mathbf{a} -link, call its successors w'_1, w'_2 . Let $(a_j)_{j \leq N}$ index the set $\text{bem}(z)$. The reduction step gives a net where $\text{em}(z)$ has been replaced by two copies of itself (if $x \in \text{em}(z)$ we denote its two representatives in the new net by x^1, x^2) joined by a row of N \mathbf{a} -links $(\mathbf{a}_j)_{j \leq N}$; i.e the two successor links of \mathbf{a}_j are a_j^1, a_j^2 . We define $\text{pr}(\mathbf{a}_j) = \text{pr}(a_j)$, so as to connect with the unmodified part of the link. The cut link (z, z') is replaced by two cut links: (w'_1, z^1) and (w'_2, z^2) .

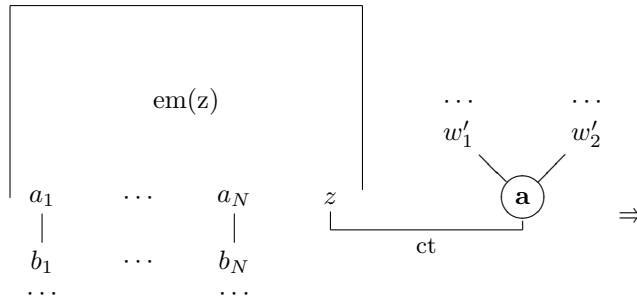

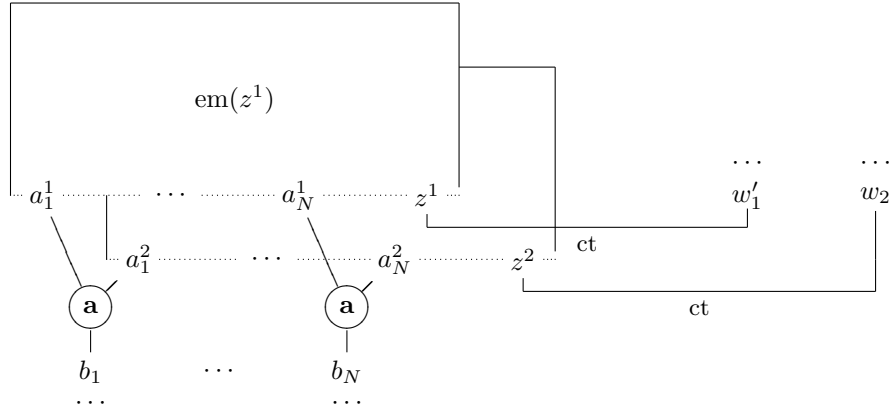

If z' is a $+_l$ -link, we know z is a $\&$ -link, say $\rho(z) = W_1 \& W_2$ and thus it has two successors w_1, w_2 above W_1, W_2 respectively. We know (15) that there is N such that the set $\text{bem}(z)$ can be enumerated into a family $(\mathbf{a}_j)_{j \leq N}$ of \mathbf{a} -links and $\text{bem}(w_k)$, $k = 1, 2$ can be enumerated as families $(a_j^k)_{j \leq N}$ such that $\text{pr}(a_j^1) = \text{pr}(a_j^2) = \mathbf{a}_j$. The reduction step replaces $\text{em}(z)$ by $\text{em}(w_j)$, where $\text{pr}(a_j) = \text{pr}(\mathbf{a}_j)$ (and call this link b_j if it exists), along with a cut (w_2, w) where w is the successor to z' .

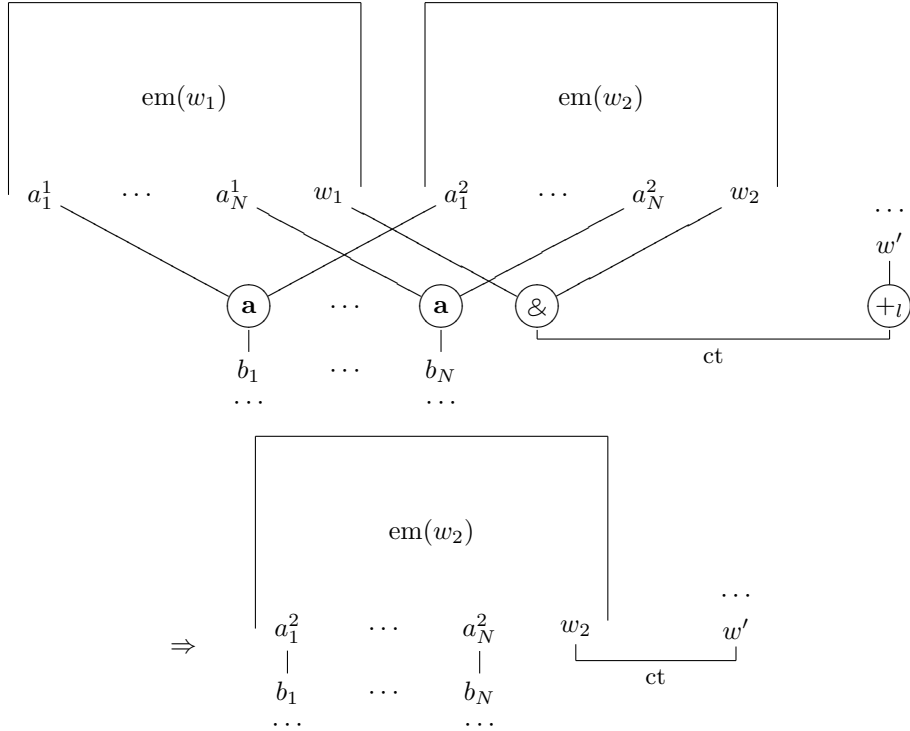

In the cases that follow z will always be a $\&$ -link; we call its successor $\&$ -link w . We know that $\text{bem}(w)$ is composed of N $\&$ -links that we name i_1, \dots, i_N , $N \geq 0$,

and the predecessor of i_i we call b_j (whether it exists or not!); while the successor of i_j always exists and is called a_j .

If z' is a j -link whose predecessor is w the reduction step puts a j -link between i_j and b_j for every j , and leaves a cut between z and w . If there is a leaf a with $\xi(a) = z$, we change this value to $\xi(a) = \mathcal{P}_o(z')$, even if z does not disappear.

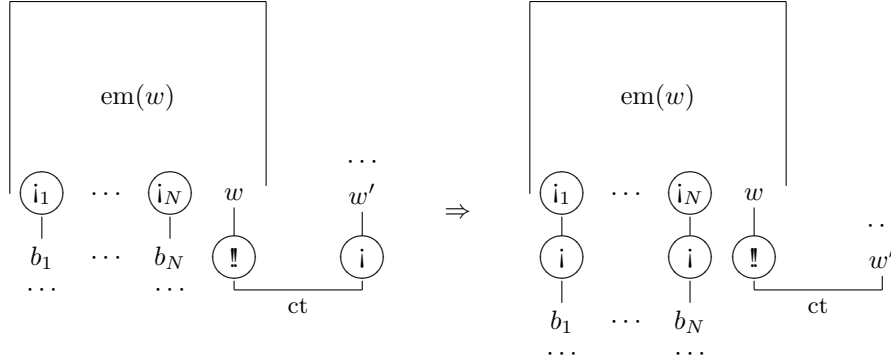

If z' is a $?$ -link with successor w' , with x being the successor of w , the reduction step removes the $!$ - $!$ pair and the string of j -links and leaves a cut (x, w') .

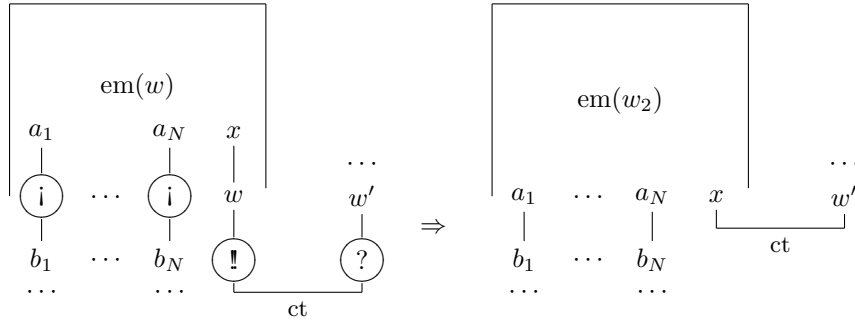

If z' is a i -link the reduction step erases z and $em(w)$, leaving only a i for each i_j . As usual for leaves a such that $\xi(a) = z$ we redefine $\xi(a) = \mathcal{P}_o(z')$

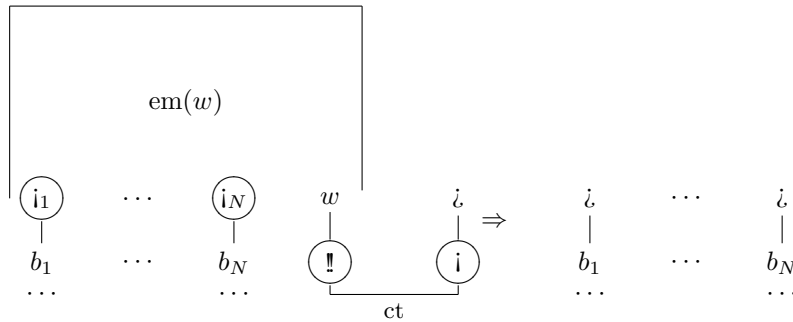

If z' is a **c**-link the diagram below should say it all. Here too we remap the leaves a such that $\xi(a) = z$ to $\xi(a) = \mathcal{P}_\circ(z')$.

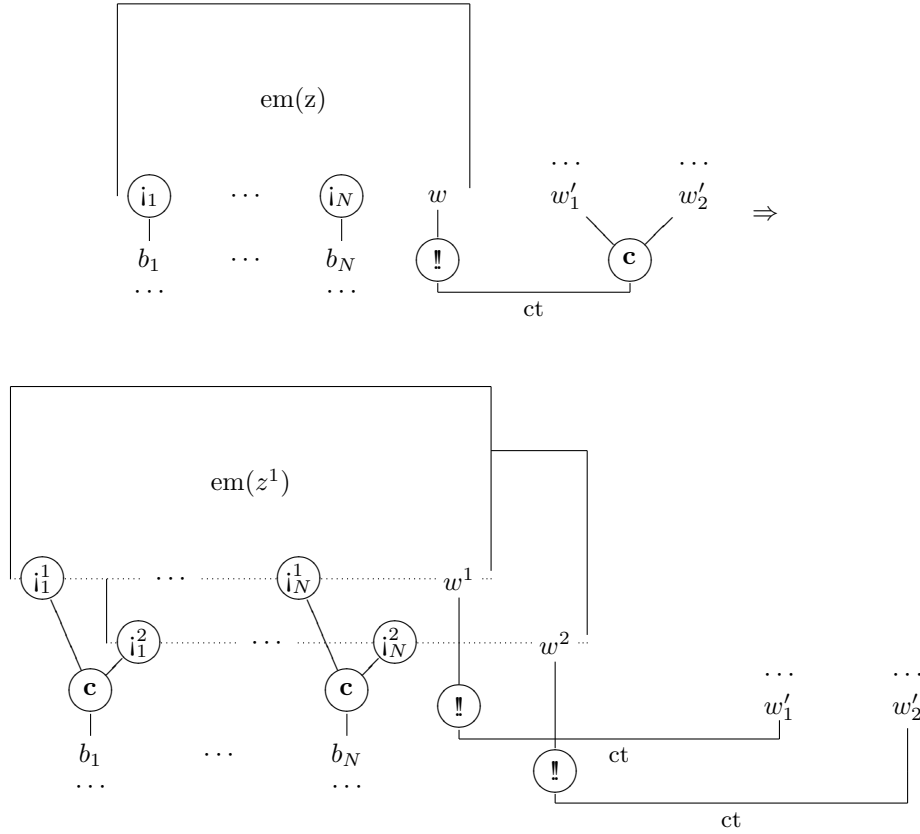

Theorem 2. *Given a correct net*

1. *Any reduction step yields a correct net.*
2. *Reduction has the Church-Rosser property.*
3. *The reduction procedures always terminates.*

4 Normal forms

We will discuss some concepts of normal form that can be applied to essential nets, allowing the identification of proofs that “should be the same”. First we can apply the fact that weakening is the co-unit in a comonoid structure and

thus the following rule makes sense

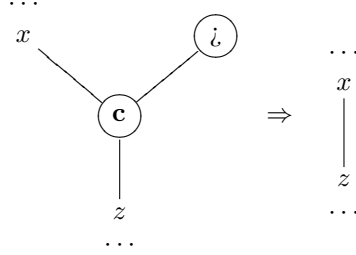

Since we have said we do not distinguish between left and right in contraction links we do not have to state the mirror image of that rule. Following this train of thought we can also evoke the fact that contraction should be a co-associative operation. This can be made explicit by introducing an infinite family $(c_n)_{n \geq 2}$ of n -ary contraction links, along with the rule scheme

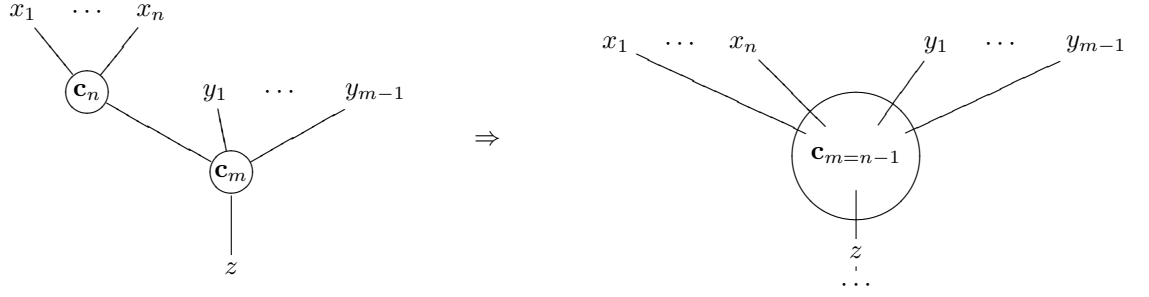

There is another aspect of essential nets from which irrelevant distinctions can be eliminated, and it is the definition of the function ξ on i -links. For an easy example look at

$$\frac{\frac{\vdash \Gamma_1 Y_1}{?X, \Gamma_1, Y_1} \quad \vdash \Gamma_2, Y_2}{\vdash ?X, \Gamma_1, \Gamma_2, Y_1 \otimes Y_2}$$

The introduction of $?X$ by weakening could also have been done on the $\vdash \Gamma_2, Y_2$ sequent, but the following proof is “more canonical” than either because the weakening has been applied as late as possible, which prevents an arbitrary choice up the proof tree:

$$\frac{\frac{\vdash \Gamma_1, Y_1^\circ \quad \vdash \Gamma_2, Y_2^\circ}{\vdash \Gamma_1, \Gamma_2, Y_1 \otimes Y_2}}{\vdash ?X, \Gamma_1, \Gamma_2, Y_1 \otimes Y_2}$$

This leads to the following definition.

Definition 7. A correct net \mathbf{A} is in ξ -normal form if for every leaf x^\bullet not an \mathbf{x}^\bullet -link, either the link $\xi(x) = \mathcal{P}_\circ(x)$ is the \triangleleft -root y , or it is such that $a = \mathcal{P}_\circ(\xi(x))$ is a $\&$ or $!$ -link, or such that $a \leq x$.

This means that the links $\xi(x)$ are always as \leq -low as they can be.

Theorem 3. *From every correct net one can obtain a new net \mathbf{A}' in ξ -normal form.*

On every suitable leaf x redefine $\xi(x)$ by applying \mathcal{P} often enough to its original value until one of the conditions above is reached. It is easy to see that these multiple applications of \mathcal{P} always conserve correctness of the net. \square

References

1. A. Asperti, V. Danos, C. Laneve, and L. Regnier. Paths in the λ -calculus. In *Ninth Annual Symposium on Logic in Computer Science (LICS)*. IEEE Press, 1994.
2. G. Bellin and J. van de Wiele. Subnets of proof-nets in MLL. In J.-Y. Girard, Y. Lafont, and L. Regnier, editors, *Advances in Linear Logic*, volume 222 of *London Mathematical Society Lecture Notes*. Cambridge Univ. Press, 1995.
3. J.-Y. Girard. A new constructive logic: Classical logic. *Math. Struct. in Comp. Sci.*, 1:255–296, 1991.
4. Jean-Yves Girard. Linear logic. *Theoretical Computer Science*, 50:1–102, 1987.
5. Jean-Yves Girard. Geometry of interaction 1: Interpretation of System F. In R. Ferro et al., editor, *Logic Colloquium 88*, pages 221–260. North-Holland, 1989.
6. G. Gonthier, M. Abadi, and J.-J. Levy. The geometry of optimal lambda reduction. In *Principles of Programming Languages (POPL)*, 1992.
7. Y. Lafont. Interaction nets. In *Proceedings of the 17th ACM symposium on Principles of Programming Languages*. ACM Press, 1990.
8. F. Lamarche. From proof nets to games (extended abstract). In J.-Y. Girard, M. Okada, and A. Scedrov, editors, *Proceedings, Linear Logic 96*, volume 3 of *Elect. Notes Theoret. Comp. Sci.*, pages 221–231. Elsevier, 1996.
9. O. Laurent. Polarized proof-nets: proof-nets for LC (extended abstract). In Jean-Yves Girard, editor, *Typed Lambda Calculi and Applications '99*, volume 1581 of *Lecture Notes in Computer Science*, pages 213–227. Springer, April 1999.
10. O. Laurent. *Etude de la Polarisation en Logique*. PhD thesis, Univ. Aix-Marseille II, 2002.
11. O. Laurent. Polarized proof-nets and $\lambda\mu$ -calculus. *Theoretical Computer Science*, 290(1):161–188, January 2003.
12. J.J. Levy. *Réductions Correctes et Optimales dans le lambda Calcul*. PhD thesis, Université Paris VII, 1978.
13. I. Mackie. *The Geometry of Implementation*. PhD thesis, Imperial College, 1994.
14. L. Regnier. *Lambda-Calcul et Réseaux*. PhD thesis, Université Paris VII, 1992.
15. Ch. Retoré. *Réseaux et Séquents Ordonnés*. PhD thesis, Université Paris VII, February 1993.